

DFS Test Report

Report No.: RF190119C10-2 R1

FCC ID: 2AA3N-TTR01

Test Model: PLTN-TTR01

Received Date: Jan. 19, 2019

Test Date: Mar. 08, 2019

Issued Date: May 08, 2019

Applicant: Peloton Interactive Inc.

Address: 125 W 25th Street, 11th Floor, New York, NY, 10001, USA

Issued By: Bureau Veritas Consumer Products Services (H.K.) Ltd., Taoyuan Branch

Lab Address: No. 47-2, 14th Ling, Chia Pau Vil., Lin Kou Dist., New Taipei City, Taiwan (R.O.C.)

Test Location: No. 19, Hwa Ya 2nd Rd., Wen Hwa Vil., Kwei Shan Dist., Taoyuan City 33383, TAIWAN (R.O.C.)

**FCC Registration /
Designation Number:** 788550 / TW0003



This report is for your exclusive use. Any copying or replication of this report to or for any other person or entity, or use of our name or trademark, is permitted only with our prior written permission. This report sets forth our findings solely with respect to the test samples identified herein. The results set forth in this report are not indicative or representative of the quality or characteristics of the lot from which a test sample was taken or any similar or identical product unless specifically and expressly noted. Our report includes all of the tests requested by you and the results thereof based upon the information that you provided to us. You have 60 days from date of issuance of this report to notify us of any material error or omission caused by our negligence, provided, however, that such notice shall be in writing and shall specifically address the issue you wish to raise. A failure to raise such issue within the prescribed time shall constitute your unqualified acceptance of the completeness of this report, the tests conducted and the correctness of the report contents. Unless specific mention, the uncertainty of measurement has been explicitly taken into account to declare the compliance or non-compliance to the specification. The report must not be used by the client to claim product certification, approval, or endorsement by TAF or any government agencies.

Table of Contents

| | |
|---|-----------|
| Release Control Record | 3 |
| 1 Certificate of Conformity | 4 |
| 2 EUT Information | 5 |
| 2.1 Operating Frequency Bands and Mode of EUT..... | 5 |
| 2.2 EUT Software and Firmware Version..... | 5 |
| 2.3 Description of Available Antennas to the EUT | 5 |
| 2.4 EUT Maximum Conducted Power..... | 6 |
| 2.5 EUT Maximum E.I.R.P. Power | 7 |
| 2.6 Transmit Power Control (TPC)..... | 7 |
| 2.7 Statement of Manufacturer..... | 7 |
| 3 U-NII DFS Rule Requirements | 8 |
| 3.1 Working Modes and Required Test Items | 8 |
| 3.2 Test Limits and Radar Signal Parameters..... | 9 |
| 4 Test & Support Equipment List | 12 |
| 4.1 Test Instruments..... | 12 |
| 4.2 Description of Support Units | 12 |
| 5 Test Procedure | 13 |
| 5.1 DFS Measurement System..... | 13 |
| 5.2 Calibration of DFS Detection Threshold Level..... | 14 |
| 5.3 Deviation from Test Standard..... | 14 |
| 5.4 Radiated Test Setup Configuration | 15 |
| 5.4.1 Client without Radar Detection Mode..... | 15 |
| 6 Test Results | 16 |
| 6.1 Summary of Test Results | 16 |
| 6.2 Test Results..... | 17 |
| 6.2.1 Test Mode: Device Operating In Client without Radar Detection Mode..... | 17 |
| 6.2.2 Channel Closing Transmission and Channel Move Time..... | 18 |
| 6.2.3 Non-Occupancy Period | 21 |
| 6.2.4 Non-Associated Test..... | 23 |
| 6.2.5 Non- Co-Channel Test..... | 23 |
| 7. Information of the Testing Laboratories | 24 |

Release Control Record

| Issue No. | Description | Date Issued |
|------------------|---------------------------------------|---------------|
| RF190119C10-2 | Original release | Mar. 18, 2019 |
| RF190119C10-2 R1 | Revised transmit power and EIRP power | May 08, 2019 |

1 Certificate of Conformity

Product: Peloton Console

Brand: PELOTON

Test Model: PLTN-TTR01

Sample Status: Engineering sample

Applicant: Peloton Interactive Inc.

Test Date: Mar. 08, 2019

Standards: FCC Part 15, Subpart E (Section 15.407)
KDB 905462 D02 UNII DFS Compliance Procedures New Rules v02
KDB 905462 D03 UNII Clients Without Radar Detection New Rules v01r02

The above equipment has been tested by **Bureau Veritas Consumer Products Services (H.K.) Ltd., Taoyuan Branch**, and found compliance with the requirement of the above standards. The test record, data evaluation & Equipment Under Test (EUT) configurations represented herein are true and accurate accounts of the measurements of the sample's RF characteristics under the conditions specified in this report.

Prepared by : Celine Chou , **Date:** May 08, 2019
Celine Chou / Senior Specialist

Approved by : Bruce Chen , **Date:** May 08, 2019
Bruce Chen / Project Engineer

2 EUT Information

2.1 Operating Frequency Bands and Mode of EUT

Table 1: Operating Frequency Bands and Mode of EUT

| Operational Mode | Operating Frequency Range | |
|--|---------------------------|--------------|
| | 5250~5350MHz | 5470~5725MHz |
| Client without radar detection and ad hoc function | ✓ | ✓ |

Note: The EUT doesn't operate in 5600 ~ 5650MHz via software controls.

2.2 EUT Software and Firmware Version

Table 2: The EUT Software/Firmware Version

| No. | Product | Model No. | Software/Firmware Version |
|-----|-----------------|------------|--|
| 1 | Peloton Console | PLTN-TTR01 | Android version: 9 Kernal version: 4.9.112+ #1 Wed Jan 16 15:14:56 EST 2019 Build number: topaz-userdebug 9 ETO 16A 25 test-keys |

2.3 Description of Available Antennas to the EUT

Table 3: Antenna List

| Ant. No. | Antenna Type | Operation Frequency Range (MHz) | Max. Gain (dBi) |
|----------|--------------|---------------------------------|-----------------|
| Main | PIFA | 5250-5725 MHz | 0.58 |
| AUX | PIFA | 5250-5725 MHz | 2.34 |

2.4 EUT Maximum Conducted Power

Table 4: The Measured Conducted Output Power

802.11a

| Frequency Band (MHz) | Max. Power | |
|----------------------|--------------------|-------------------|
| | Output Power (dBm) | Output Power (mW) |
| 5250~5350 | 20.63 | 115.490 |
| 5470~5725 | 23.17 | 207.598 |

802.11n HT20

| Frequency Band (MHz) | Max. Power | |
|----------------------|--------------------|-------------------|
| | Output Power (dBm) | Output Power (mW) |
| 5250~5350 | 20.55 | 113.533 |
| 5470~5725 | 23.49 | 223.375 |

802.11n HT40

| Frequency Band (MHz) | Max. Power | |
|----------------------|--------------------|-------------------|
| | Output Power (dBm) | Output Power (mW) |
| 5250~5350 | 20.60 | 114.695 |
| 5470~5725 | 23.95 | 248.053 |

802.11ac VHT80

| Frequency Band (MHz) | Max. Power | |
|----------------------|--------------------|-------------------|
| | Output Power (dBm) | Output Power (mW) |
| 5250~5350 | 20.65 | 116.155 |
| 5470~5725 | 21.57 | 143.435 |

2.5 EUT Maximum E.I.R.P. Power

Table 5: The EIRP Output Power List

802.11a

| Frequency Band (MHz) | Max. EIRP Power | |
|----------------------|--------------------|-------------------|
| | Output Power (dBm) | Output Power (mW) |
| 5250~5350 | 22.97 | 198.153 |
| 5470~5725 | 25.51 | 355.631 |

802.11n HT20

| Frequency Band (MHz) | Max. EIRP Power | |
|----------------------|--------------------|-------------------|
| | Output Power (dBm) | Output Power (mW) |
| 5250~5350 | 22.89 | 194.536 |
| 5470~5725 | 25.83 | 382.825 |

802.11n HT40

| Frequency Band (MHz) | Max. EIRP Power | |
|----------------------|--------------------|-------------------|
| | Output Power (dBm) | Output Power (mW) |
| 5250~5350 | 22.94 | 196.789 |
| 5470~5725 | 26.29 | 425.598 |

802.11ac VHT80

| Frequency Band (MHz) | Max. EIRP Power | |
|----------------------|--------------------|-------------------|
| | Output Power (dBm) | Output Power (mW) |
| 5250~5350 | 22.99 | 199.067 |
| 5470~5725 | 23.91 | 246.037 |

2.6 Transmit Power Control (TPC)

U-NII devices operating in the 5.25-5.35 GHz band and the 5.47-5.725 GHz band shall employ a TPC mechanism. The U-NII device is required to have the capability to operate at least 6 dB below the mean EIRP value of 30 dBm. A TPC mechanism is not required for systems with an e.i.r.p. of less than 500 mW.

Maximum EIRP of this device is 425.598mW which less than 500mW, therefore it's not require TPC function.

| Applicable | E.I.R.P | FCC 15.407 (h)(1) |
|------------|---------|--|
| | >500mW | The TPC mechanism is required for system with an E.I.R.P of above 500mW |
| √ | <500mW | The TPC mechanism is not required for system with an E.I.R.P of less 500mW |

2.7 Statement of Manufacturer

Manufacturer statement confirming that information regarding the parameters of the detected Radar Waveforms is not available to the end user. **And the device doesn't have Ad Hoc mode on DFS frequency band.**

3 U-NII DFS Rule Requirements

3.1 Working Modes and Required Test Items

The manufacturer shall state whether the UUT is capable of operating as a Master and/or a Client. If the UUT is capable of operating in more than one operating mode then each operating mode shall be tested separately. See tables 6 and 7 for the applicability of DFS requirements for each of the operational modes.

Table 6: Applicability of DFS Requirements Prior To Use a Channel

| Requirement | Operational Mode | | |
|---------------------------------|------------------|--------------------------------|-----------------------------|
| | Master | Client without radar detection | Client with radar detection |
| Non-Occupancy Period | ✓ | ✓ note | ✓ |
| DFS Detection Threshold | ✓ | Not required | ✓ |
| Channel Availability Check Time | ✓ | Not required | Not required |
| U-NII Detection Bandwidth | ✓ | Not required | ✓ |

Note: Per KDB 905462 D03 UNII Clients Without Radar Detection New Rules v01r02 section (b)(5/6), If the client moves with the master, the device is considered compliant if nothing appears in the client non-occupancy period test. For devices that shut down (rather than moving channels), no beacons should appear. An analyzer plot that contains a single 30-minute sweep on the original channel.

Table 7: Applicability of DFS Requirements during Normal Operation.

| Requirement | Operational Mode | |
|-----------------------------------|---------------------------------------|--------------------------------|
| | Master or Client with radar detection | Client without radar detection |
| DFS Detection Threshold | ✓ | Not required |
| Channel Closing Transmission Time | ✓ | ✓ |
| Channel Move Time | ✓ | ✓ |
| U-NII Detection Bandwidth | ✓ | Not required |

| Additional requirements for devices with multiple bandwidth modes | Master or Client with radar detection | Client without radar detection |
|---|---------------------------------------|--|
| U-NII Detection Bandwidth and Statistical Performance Check | All BW modes must be tested | Not required |
| Channel Move Time and Channel Closing Transmission Time | Test using widest BW mode available | Test using the widest BW mode available for the link |
| All other tests | Any single BW mode | Not required |

Note: Frequencies selected for statistical performance check (Section 7.8.4) should include several frequencies within the radar detection bandwidth and frequencies near the edge of the radar detection bandwidth. For 802.11 devices it is suggested to select frequencies in each of the bonded 20 MHz channels and the channel center frequency.

3.2 Test Limits and Radar Signal Parameters

Detection Threshold Values

Table 8: DFS Detection Thresholds for Master Devices And Client Devices With Radar Detection

| Maximum Transmit Power | Value (See Notes 1, 2, and 3) |
|--|----------------------------------|
| EIRP \geq 200 milliwatt | -64 dBm |
| EIRP < 200 milliwatt and power spectral density < 10 dBm/MHz | -62 dBm |
| EIRP < 200 milliwatt that do not meet the power spectral density requirement | -64 dBm |

Note 1: This is the level at the input of the receiver assuming a 0 dBi receive antenna.

Note 2: Throughout these test procedures an additional 1 dB has been added to the amplitude of the test transmission waveforms to account for variations in measurement equipment. This will ensure that the test signal is at or above the detection threshold level to trigger a DFS response.

Note3: EIRP is based on the highest antenna gain. For MIMO devices refer to KDB Publication 662911 D01.

Table 9: DFS Response Requirement Values

| Parameter | Value |
|-----------------------------------|---|
| Non-occupancy period | Minimum 30 minutes |
| Channel Availability Check Time | 60 seconds |
| Channel Move Time | 10 seconds See Note 1. |
| Channel Closing Transmission Time | 200 milliseconds + an aggregate of 60 milliseconds over remaining 10 second period. See Notes 1 and 2. |
| U-NII Detection Bandwidth | Minimum 100% of the U-NII 99% transmission power bandwidth. See Note 3 |

Note 1: Channel Move Time and the Channel Closing Transmission Time should be performed with Radar Type 0. The measurement timing begins at the end of the Radar Type 0 burst.

Note 2: The Channel Closing Transmission Time is comprised of 200 milliseconds starting at the beginning of the Channel Move Time plus any additional intermittent control signals required to facilitate a Channel move (an aggregate of 60 milliseconds) during the remainder of the 10 second period. The aggregate duration of control signals will not count quiet periods in between transmissions.

Note 3: During the U-NII Detection Bandwidth detection test, radar type 0 should be used. For each frequency step the minimum percentage of detection is 90 percent. Measurements are performed with no data traffic.

Parameters of DFS Test Signals

Step intervals of 0.1 microsecond for Pulse Width, 1 microsecond for PRI, 1 MHz for chirp width and 1 for the number of pulses will be utilized for the random determination of specific test waveforms.

Table 10: Short Pulse Radar Test Waveforms

| Radar Type | Pulse Width (μsec) | PRI (μsec) | Number of Pulses | Minimum Percentage of Successful Detection | Minimum Number of Trials |
|--|--------------------|---|--|--|--------------------------|
| 0 | 1 | 1428 | 18 | See Note 1 | See Note 1 |
| 1 | 1 | Test A: 15 unique PRI values randomly selected from the list of 23 PRI values in Table 5a ----- Test B: 15 unique PRI values randomly selected within the range of 518-3066 μ sec, with a minimum increment of 1 μ sec, excluding PRI values selected in Test A | $\text{Roundup} \left\{ \begin{array}{l} \left(\frac{1}{360} \right) \\ \left(\frac{19 \cdot 10^6}{\text{PRI}_{\mu\text{sec}}} \right) \end{array} \right\}$ | 60% | 30 |
| 2 | 1-5 | 150-230 | 23-29 | 60% | 30 |
| 3 | 6-10 | 200-500 | 16-18 | 60% | 30 |
| 4 | 11-20 | 200-500 | 12-16 | 60% | 30 |
| Aggregate (Radar Types 1-4) | | | | 80% | 120 |
| Note 1: Short Pulse Radar Type 0 should be used for the detection bandwidth test, channel move time, and channel closing time tests. | | | | | |

Table 11: Long Pulse Radar Test Waveform

| Radar Type | Pulse Width (μsec) | Chirp Width (MHz) | PRI (μsec) | Number Of Pulses Per Burst | Number Of Bursts | Minimum Percentage Of Successful Detection | Minimum Number Of Trials |
|------------|--------------------|-------------------|------------|----------------------------|------------------|--|--------------------------|
| 5 | 50-100 | 5-20 | 1000-2000 | 1-3 | 8-20 | 80% | 30 |

Three subsets of trials will be performed with a minimum of ten trials per subset. The subset of trials differ in where the Long Pulse Type 5 Signal is tuned in frequency.

- a) the Channel center frequency
- b) tuned frequencies such that 90% of the Long Pulse Type 5 frequency modulation is within the low edge of the UUT Occupied Bandwidth
- c) tuned frequencies such that 90% of the Long Pulse Type 5 frequency modulation is within the high edge of the UUT Occupied Bandwidth

It include 10 trails for every subset, the formula as below,

For subset case 1: the center frequency of the signal generator will remain fixed at the center of the UUT Channel.

For subset case 2: to retain 90% frequency overlap between the radar signal and the UUT Occupied Bandwidth, the center frequency of the signal generator will vary for each of the ten trials in subset case 2. The center frequency of the signal generator for each trial is calculated by:

$$FL+(0.4*Chirp\ Width\ [in\ MHz])$$

For subset case 3: to retain 90% frequency overlap between the radar signal and the UUT Occupied Bandwidth, the center frequency of the signal generator will vary for each of the ten trials in subset case 3. The center frequency of the signal generator for each trial is calculated by:

$$FH-(0.4*Chirp\ Width\ [in\ MHz])$$

Table 12: Frequency Hopping Radar Test Waveform

| Radar Type | Pulse Width (μsec) | PRI (μsec) | Pulses per Hop | Hopping Rate (kHz) | Hopping Sequence Length (msec) | Minimum Percentage Of Successful Detection | Minimum Number Of Trials |
|------------|--------------------|------------|----------------|--------------------|--------------------------------|--|--------------------------|
| 6 | 1 | 333 | 9 | 0.333 | 300 | 70% | 30 |

4 Test & Support Equipment List

4.1 Test Instruments

Table 13: Test Instruments List

| Description & Manufacturer | Model No. | Brand | Date Of Calibration | Due Date Of Calibration |
|----------------------------|--------------|--------------|---------------------|-------------------------|
| Spectrum analyzer | FSV40 | R&S | Apr. 17,2018 | Apr. 16,2019 |
| Signal generator | MXG | KEYSIGHT | Dec. 24, 2018 | Dec. 23,2019 |
| Horn antenna | BBHA 9120 D | Schwarzbeck | Nov. 25, 2018 | Nov. 24, 2019 |
| RF coaxial cable | SUCOFLEX 104 | HUBER SUHNER | Aug. 23, 2018 | Aug. 22, 2019 |

4.2 Description of Support Units

Table 14: Support Unit Information.

| No. | Product | Brand | Model No. | FCC ID | Gain |
|-----|---------|---------|-----------|-------------|--|
| 1 | Router | NETGEAR | R7800 | PY315100319 | 5G Ant gain : 1.61dBi Maximum EIRP : 25.47dBm |

Note: This device was functioned as a Master Slave device during the DFS test.

Table 15: Software/Firmware Information.

| No. | Product | Model No. | Software/Firmware Version |
|-----|---------|-----------|---------------------------|
| 1. | Router | R7800 | V1.0.2.36 |

5 Test Procedure

5.1 DFS Measurement System

A complete DFS Measurement System consists of two subsystems: (1) the Radar Signal Generating Subsystem and (2) the Traffic Monitoring Subsystem. The control PC is necessary for generating the Radar waveforms in Table 10, 11 and 12. The traffic monitoring subsystem is specified to the type of unit under test (UUT).

Radiated Setup Configuration of DFS Measurement System

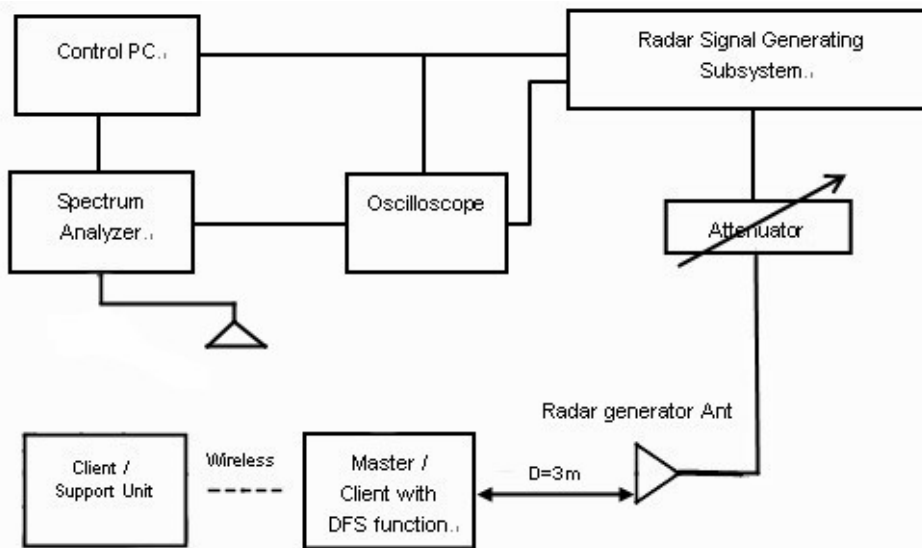

System testing will be performed with channel-loading using means appropriate to the data types that are used by the unlicensed device. The following requirements apply:

| | |
|---|--|
| | a) The data file must be of a type that is typical for the device (i.e., MPEG-2, MPEG-4, WAV, MP3, MP4, AVI, etc.) and must generally be transmitting in a streaming mode. |
| | b) Software to ping the client is permitted to simulate data transfer but must have random ping intervals. |
| V | c) Timing plots are required with calculations demonstrating a minimum channel loading of approximately 17% or greater. |
| | d) Unicast or Multicast protocols are preferable but other protocols may be used. The appropriate protocol used must be described in the test procedures. |

Wireless Traffic Loading Duty Cycle

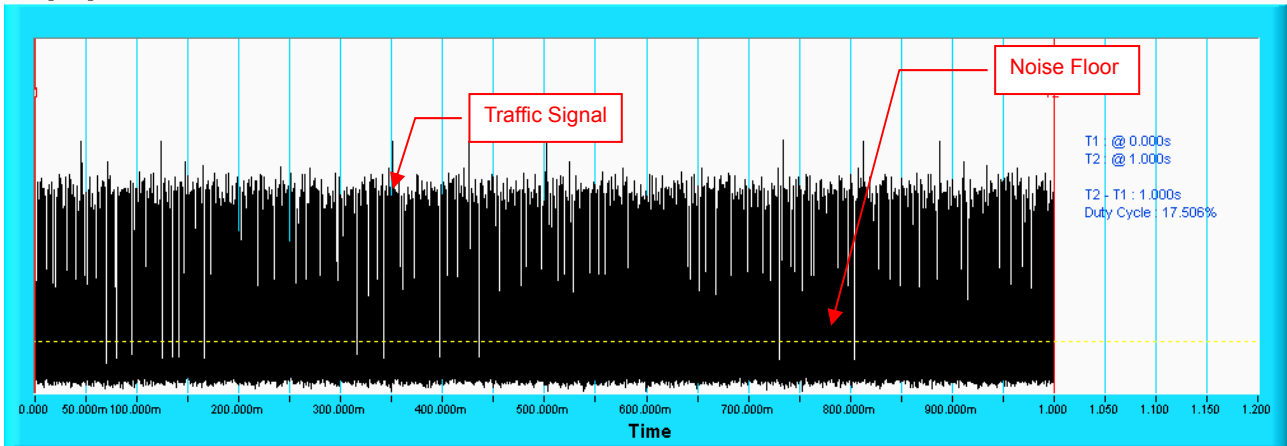

5.2 Calibration of DFS Detection Threshold Level

The measured channel is 5500MHz, 5510MHz and 5530MHz. The radar signal was the same as transmitted channels, and injected into the antenna of AP (master) or Client Device with Radar Detection, measured the channel closing transmission time and channel move time. The calibrated conducted detection threshold level is set to -64dBm. The tested level is lower than required level hence it provides margin to the limit.

Radiated setup configuration of Calibration of DFS Detection Threshold Level

The radar signal generate system is generating waveform pattern of radar types. The amplitude of the radar signal generator system is adjusted to yield a level of - 64 dBm as measured on the spectrum analyzer.

The interference detection threshold level is lower than - 64dBm hence it provides margin to the limit.

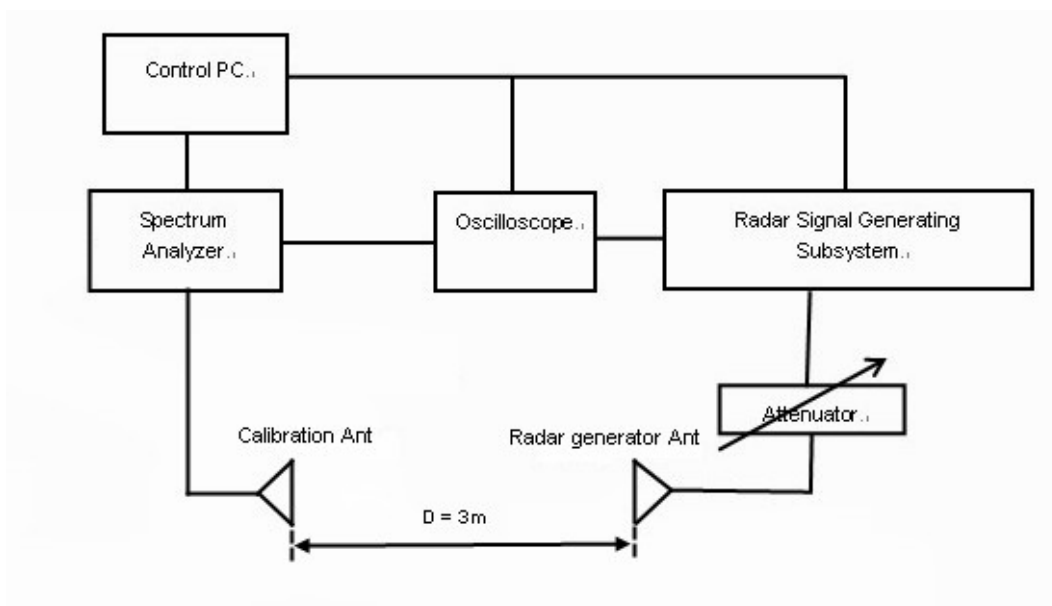

5.3 Deviation from Test Standard

No deviation.

5.4 Radiated Test Setup Configuration

5.4.1 Client without Radar Detection Mode

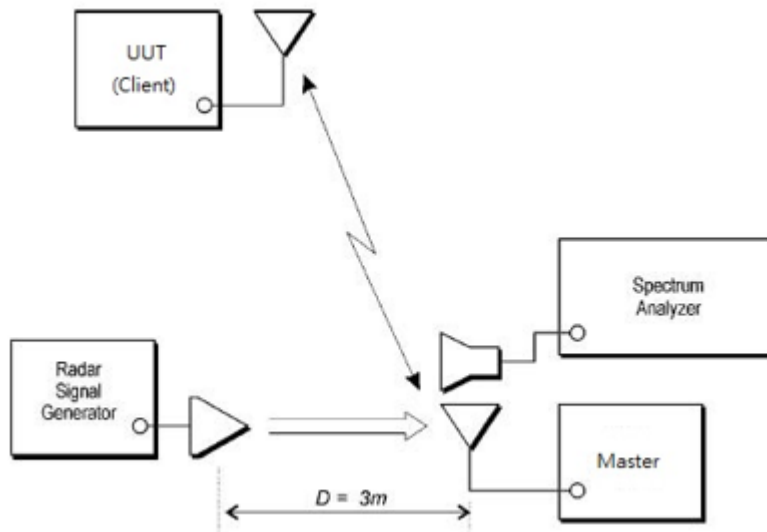

The UUT is a U-NII Device operating in Client mode without radar detection. The radar test signals are injected into the Master Device.

6 Test Results

6.1 Summary of Test Results

| Clause | Test Parameter | Remarks | Pass/Fail |
|--------|-----------------------------------|----------------|-----------|
| 15.407 | DFS Detection Threshold | Not Applicable | NA |
| 15.407 | Channel Availability Check Time | Not Applicable | NA |
| 15.407 | Channel Move Time | Applicable | Pass |
| 15.407 | Channel Closing Transmission Time | Applicable | Pass |
| 15.407 | Non- Occupancy Period | Applicable | Pass |
| 15.407 | Uniform Spreading | Not Applicable | NA |
| 15.407 | U-NII Detection Bandwidth | Not Applicable | NA |
| 15.407 | Non-associated test | Applicable | Pass |
| 15.407 | Non-Co-Channel test | Applicable | Pass |

6.2 Test Results

6.2.1 Test Mode: Device Operating In Client without Radar Detection Mode.

Client with injection at the Master. (The radar test signals are injected into the Master Device)

DFS Detection Threshold

For detection threshold level of -64dBm, the required signal strength at AP antenna location is -64 dBm.

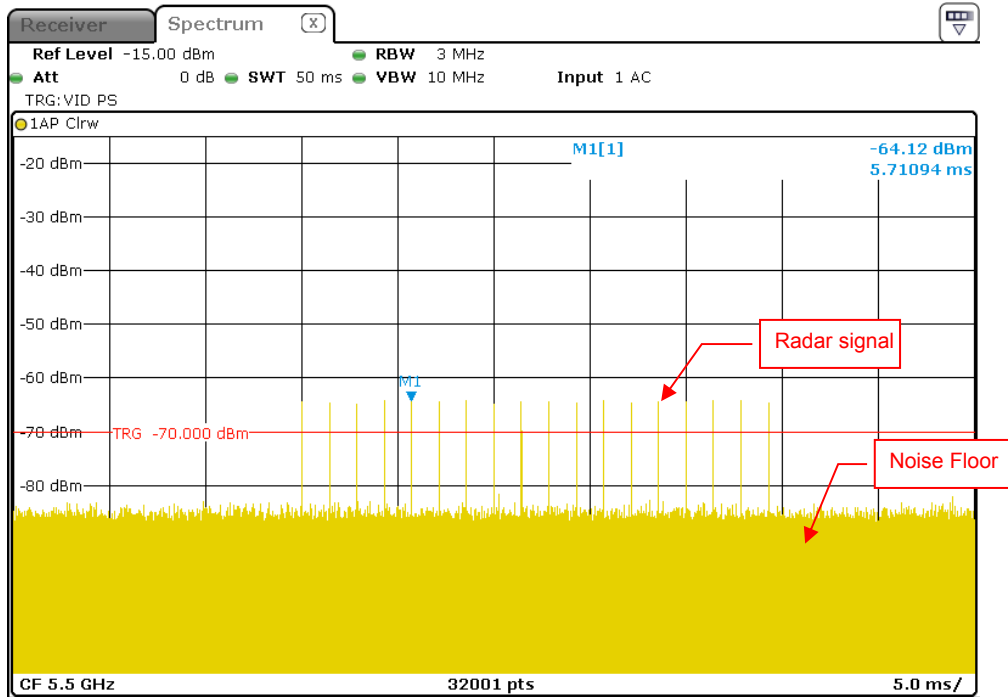

Radar Signal 0

6.2.2 Channel Closing Transmission and Channel Move Time

Radar Signal 0

802.11n HT20

Channel Closing Transmission Time & Channel Move Time

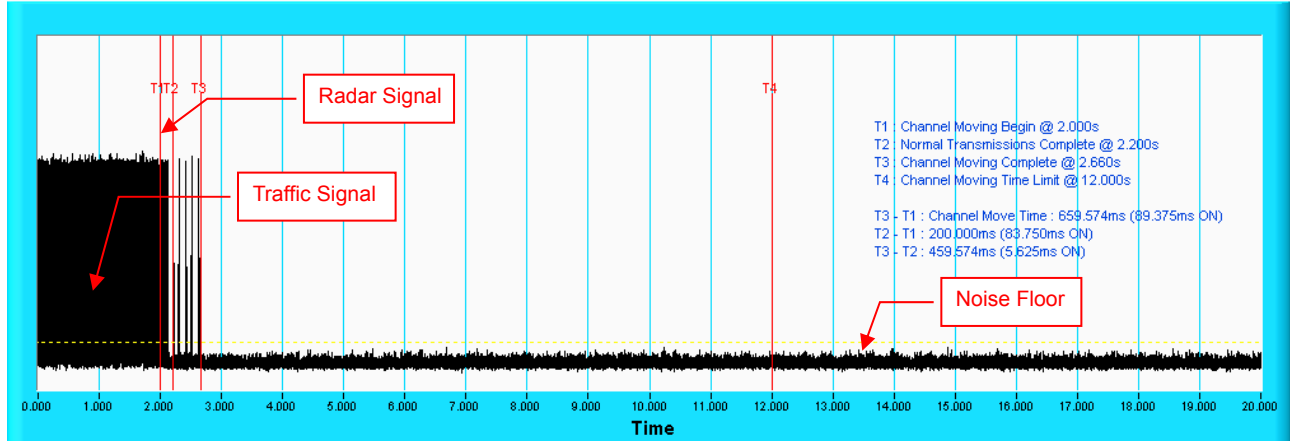

Note: T1 denotes the start of Channel Move Time upon the end of the last Radar burst. T2 denotes the data transmission time of 200ms from T1. T3 denotes the end of Channel Move Time. T4 denotes the 10 second from T1 to observe the aggregate duration of transmissions.

Channel Closing Transmission Time & Channel Move Time

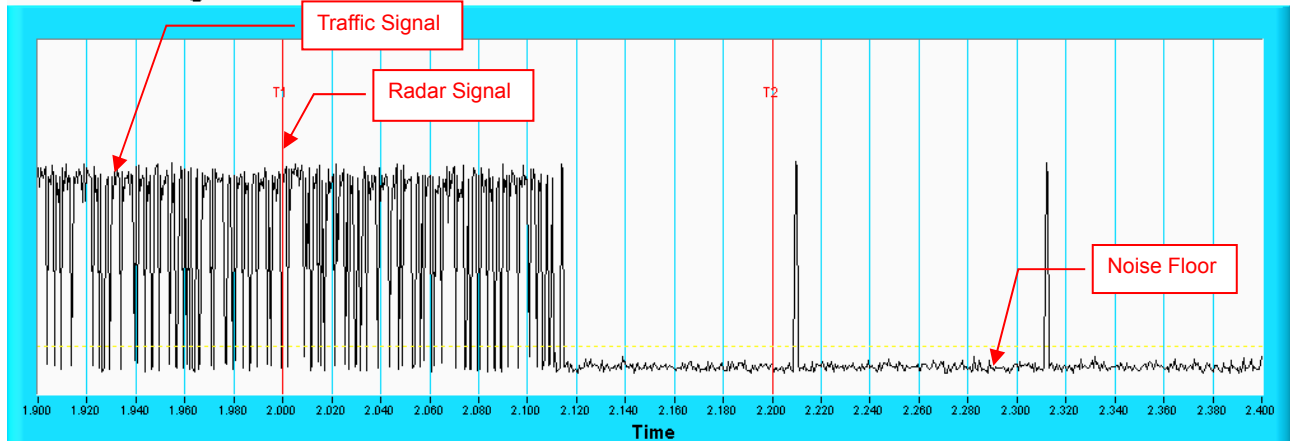

Note: An expanded plot for the device vacates the channel in the required 500ms.

Radar Signal 0
802.11n HT40

Channel Closing Transmission Time & Channel Move Time

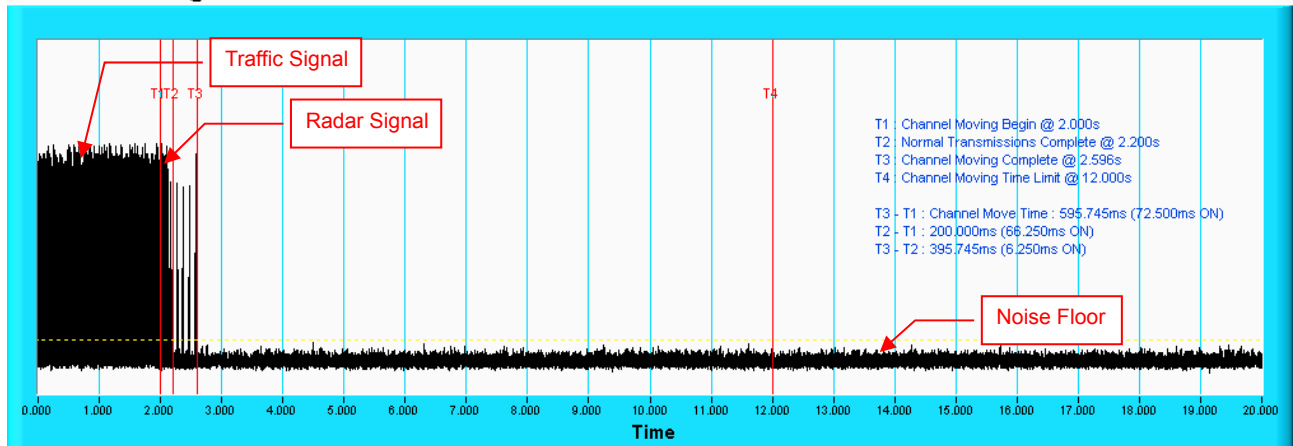

Note: T1 denotes the start of Channel Move Time upon the end of the last Radar burst. T2 denotes the data transmission time of 200ms from T1. T3 denotes the end of Channel Move Time. T4 denotes the 10 second from T1 to observe the aggregate duration of transmissions.

Channel Closing Transmission Time & Channel Move Time

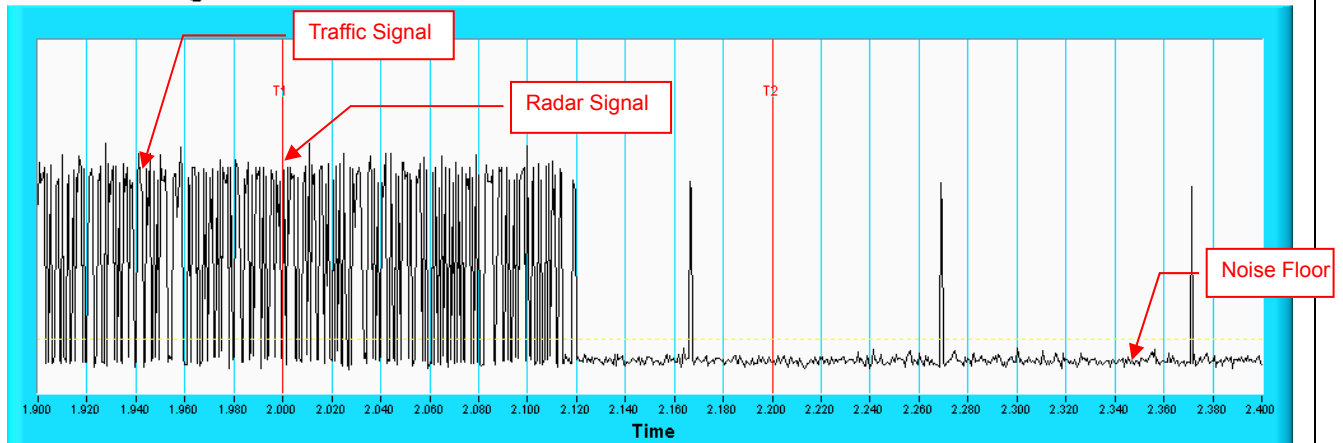

Note: An expanded plot for the device vacates the channel in the required 500ms.

Radar Signal 0
802.11ac VHT80

Channel Closing Transmission Time & Channel Move Time

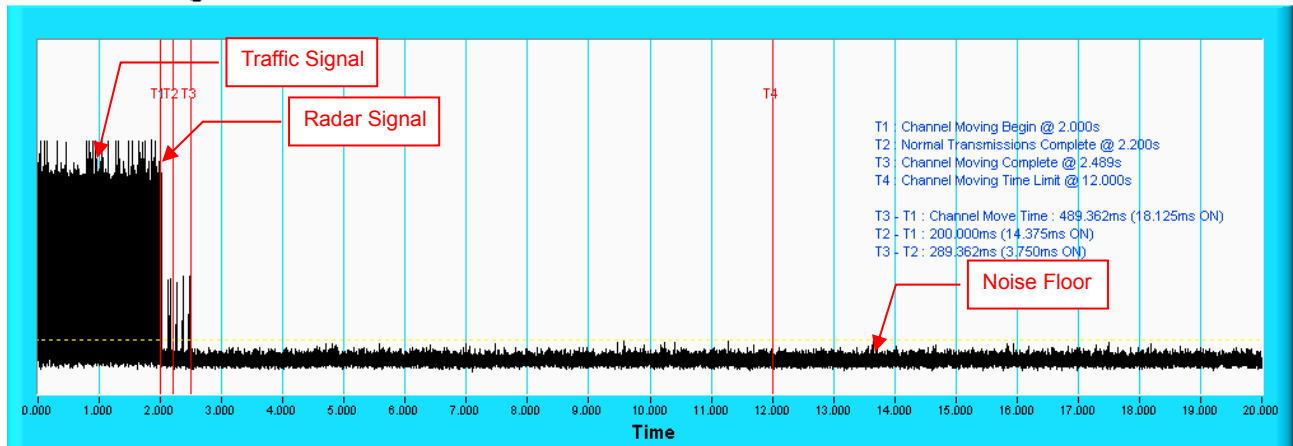

Note: T1 denotes the start of Channel Move Time upon the end of the last Radar burst. T2 denotes the data transmission time of 200ms from T1. T3 denotes the end of Channel Move Time. T4 denotes the 10 second from T1 to observe the aggregate duration of transmissions.

Channel Closing Transmission Time & Channel Move Time

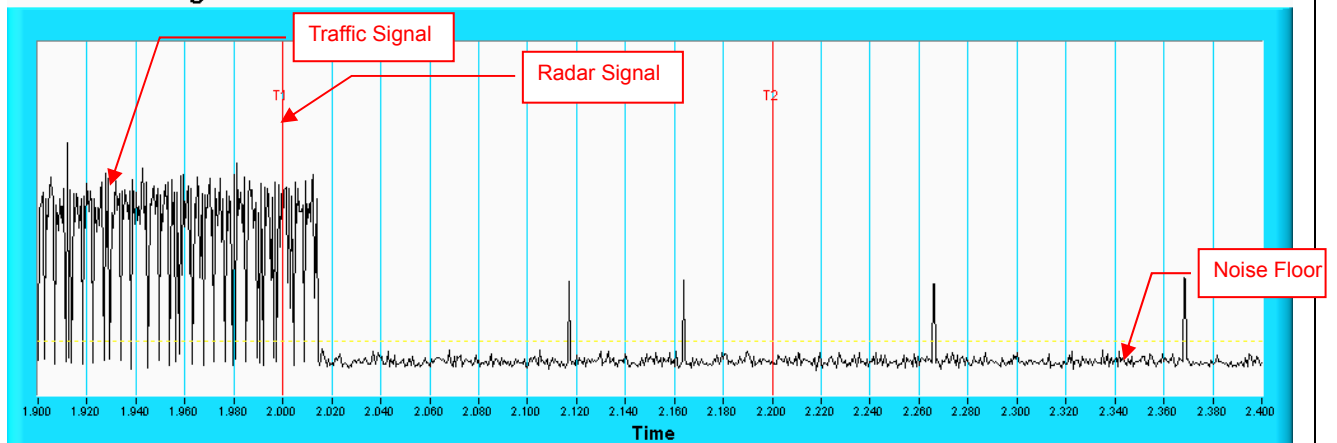

Note: An expanded plot for the device vacates the channel in the required 500ms.

6.2.3 Non-Occupancy Period

Associate test:

During the 30 minutes observation time, UUT did not make any transmissions on a channel after a radar signal was detected on that channel by either the Channel Availability Check or the In-Service Monitoring.

- 1) EUT (Client) links with master on 5500MHz.

Waveform of EUT links up with Master

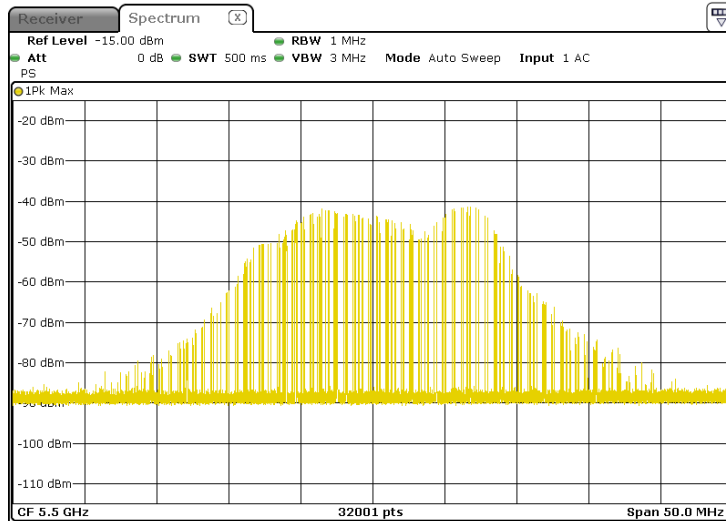

- 2) Client plays specified files via master.

Waveform of transmission

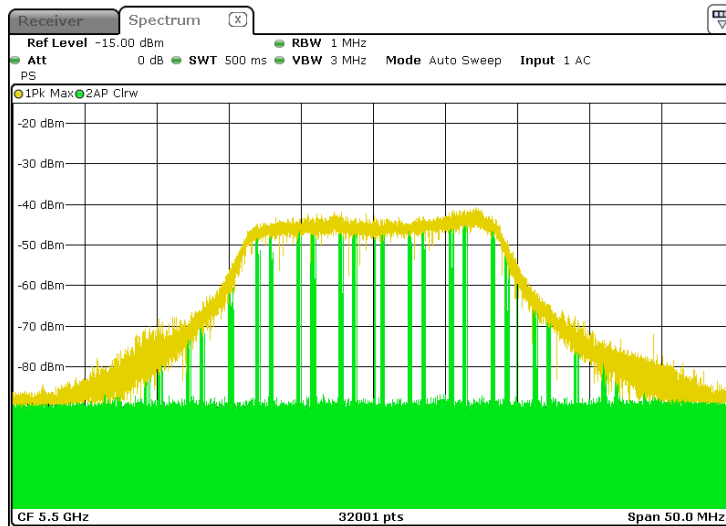

3) Radar signal 0 is applied to the Master device and WiFi traffic signal stop immediately.

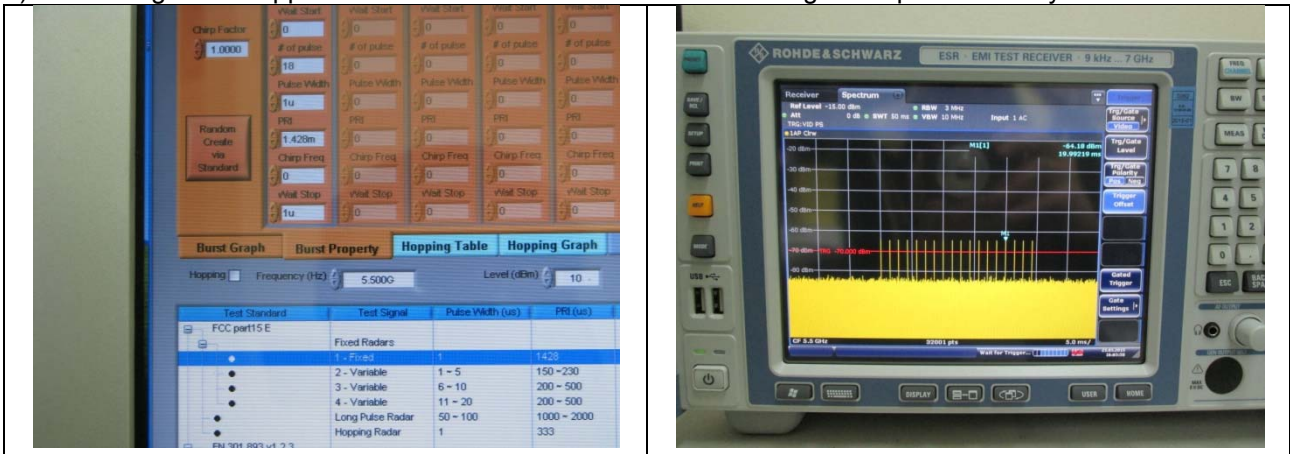

4) 5500MHz has been monitored in 30 minutes period. In this period, no any transmission occurs.

Plot of 30minutes period

802.11n HT20

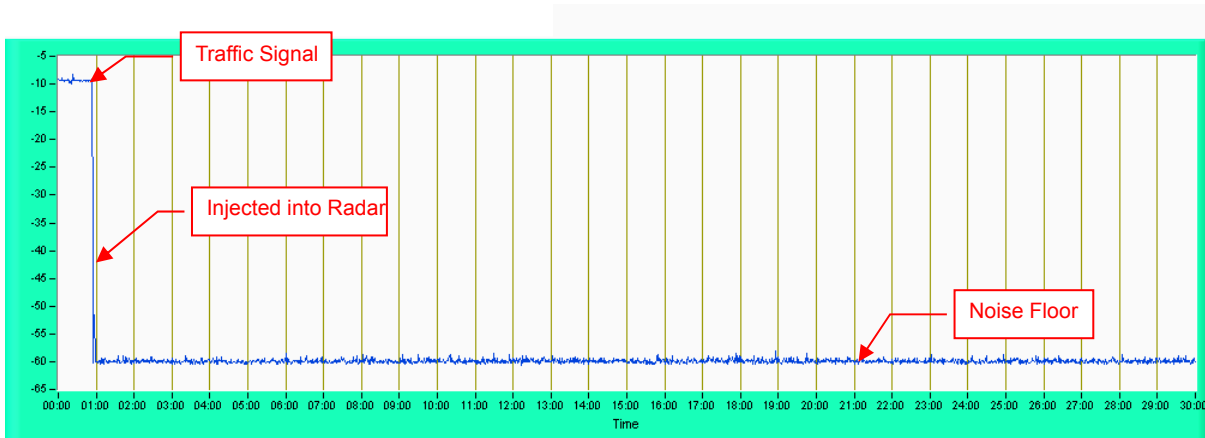

Note: Test setup are shown on Test setup photo.pdf

6.2.4 Non-Associated Test

Master was off.

During the 30 minutes observation time, The UUT did not make any transmissions in the DFS band after UUT power up.

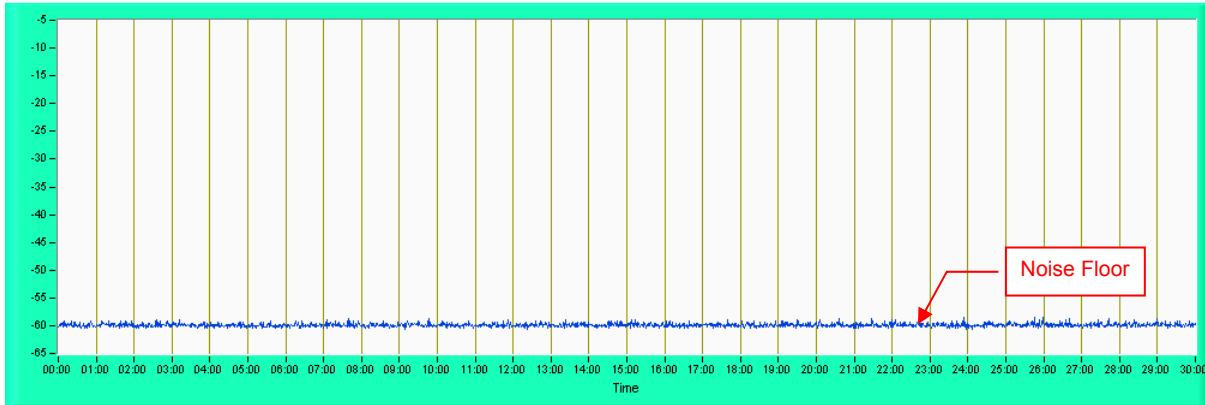

6.2.5 Non- Co-Channel Test

The UUT was investigated after radar was detected and confirmed that no co-channel operation with radars.

7. Information of the Testing Laboratories

We, Bureau Veritas Consumer Products Services (H.K.) Ltd., Taoyuan Branch, were founded in 1988 to provide our best service in EMC, Radio, Telecom and Safety consultation. Our laboratories are FCC recognized accredited test firms and accredited and approved according to ISO/IEC 17025.

If you have any comments, please feel free to contact us at the following:

Lin Kou EMC/RF Lab

Tel: 886-2-26052180

Fax: 886-2-26051924

Hsin Chu EMC/RF/Telecom Lab

Tel: 886-3-6668565

Fax: 886-3-6668323

Hwa Ya EMC/RF/Safety Lab

Tel: 886-3-3183232

Fax: 886-3-3270892

Email: service.adt@tw.bureauveritas.com

Web Site: www.bureauveritas-adt.com

The address and road map of all our labs can be found in our web site also.

--- END ---