

## 5. Emissions in Restricted Frequency Bands (Radiated emission measurements)

### 5.1 Operating environment

Temperature:	25	°C
Relative Humidity:	55	%
Atmospheric Pressure	1008	hPa
Channel number	36,44,48,149,157,161 for 20MHz 38,46,151,159 for 40MHz	

### 5.2 Limit for emission in restricted frequency bands (Radiated emission measurement)

Frequency (MHz)	Field Strength (microvolts/meter)	Measurement distance (meters)
0.009~0.490	2400/F(kHz)	300
0.490~1.705	2400/F(kHz)	30
1.705~30	30	30
30-88	100	3
88-216	150	3
216-960	200	3
Above 960	500	3

Remark:

1. In the above table, the tighter limit applies at the band edges.
2. Distance refers to the distance in meters between the measuring instrument antenna and the closed point of any part of the device or system

As specified in 15.407(b), For transmitters operating in the 5.15-5.25 GHz band: All emissions outside of the 5.15-5.35 GHz band shall not exceed an e.i.r.p. of -27 dBm/MHz.

(2) For transmitters operating in the 5.25-5.35 GHz band: All emissions outside of the 5.15-5.35 GHz band shall not exceed an e.i.r.p. of -27 dBm/MHz.

(3) For transmitters operating in the 5.47-5.725 GHz band: All emissions outside of the 5.47-5.725 GHz band shall not exceed an e.i.r.p. of -27 dBm/MHz.

**TEST REPORT**

(4) For transmitters operating in the 5.725-5.85 GHz band:

All emissions shall be limited to a level of -27 dBm/MHz at 75 MHz or more above or below the band edge increasing linearly to 10 dBm/MHz at 25 MHz above or below the band edge, and from 25 MHz above or below the band edge increasing linearly to a level of 15.6 dBm/MHz at 5 MHz above or below the band edge, and from 5 MHz above or below the band edge increasing linearly to a level of 27 dBm/MHz at the band edge.

However, an out-of-band emission that complies with both the average and peak limits of 15.209 is not required to satisfy the -27 dBm/MHz or -17 dBm/MHz peak emission limit.

**5.3 Measuring instrument setting**

**Below 1GHz measurement**

Receiver settings	
Receiver function	Setting
Detector	QP
RBW	9-150 kHz ; 200-300 Hz 0.15-30 MHz; 9-10 kHz 30-1000 MHz; 100-120 kHz
VBW	≥ 3 x RBW
Sweep	Auto couple
Attenuation	Auto

**Above 1GHz measurement**

Spectrum analyzer settings	
Spectrum Analyzer function	Setting
Detector	Peak
RBW	1MHz
VBW	3MHz for Peak; 10Hz for Average
Sweep	Auto couple
Start Frequency	1GHz
Stop Frequency	Tenth harmonic
Attenuation	Auto

## 5.4 Test procedure

1. Configure the EUT according to ANSI C63.10: 2013 The EUT was placed on the top of the turntable 1.5 meter above ground for above 1GHz and placed on the top of the turntable 0.8 meter above ground for below 1GHz. The center of the receiving antenna mounted on the top of a height-variable antenna tower was placed 3 meters far away from the turntable.
2. Power on the EUT and all the companion devices. The turntable was rotated by 360 degree to find the position of the maximum emission level.
3. The height of the receiving antenna was varied between one meter and four meters above ground to find the maximum emission field strength of the both horizontal and vertical polarization
4. If find the frequencies above the limit or below within 3dB, the antenna tower was scan (from 1m to 4m) and then the turntable was rotated to find the maximum reading.
5. Set the test-receiver system to peak or CISPR quasi-peak detector with specified bandwidth under maximum hold mode.
6. For emissions above 1GHz, use 1MHz VBW and 3MHz RBW for peak reading. Then 1MHz RBW and 10Hz VBW for average reading in spectrum analyzer.  
Place the measurement antenna away from each area of the EUT determined to be a source of emissions at the specified measurement distance, while keeping the measurement antenna aimed at the source of emissions at each frequency of significant emissions, with polarization oriented for maximum response.
7. If the emissions level of the EUT in peak mode was 3dB lower than the average limit specified then testing will be stopped and peak values of the EUT will be reported. Otherwise, the emissions which do not have 3dB margin will be measured using the quasi-peak method for below 1GHz.
8. For testing above 1GHz, The emissions level of the EUT in peak mode was lower than average limit, then testing will be stopped and peak values of the EUT will be reported, otherwise, the emission will be measured in average mode again and reported.
9. In case the emission is lower than 30MHz, loop antenna has to be used for measurement and the recorded data should be quasi-peak measured by receiver.

### 5.5 Test configuration

#### 5.5.1 Radiated emission from 9 kHz to 30MHz using Loop Antenna

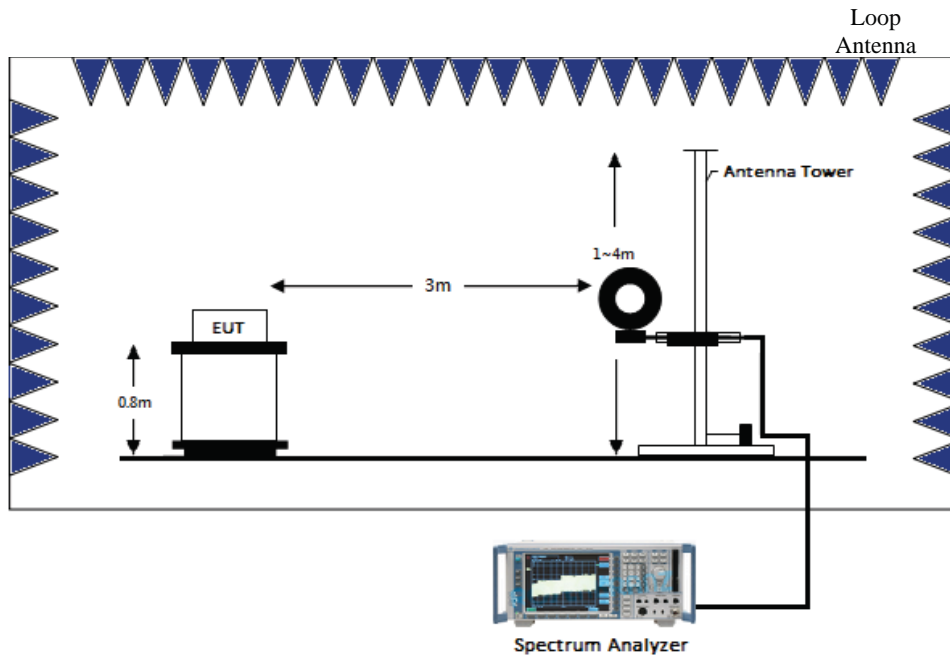

#### 5.5.2 Radiated emission below 1GHz using Bilog Antenna

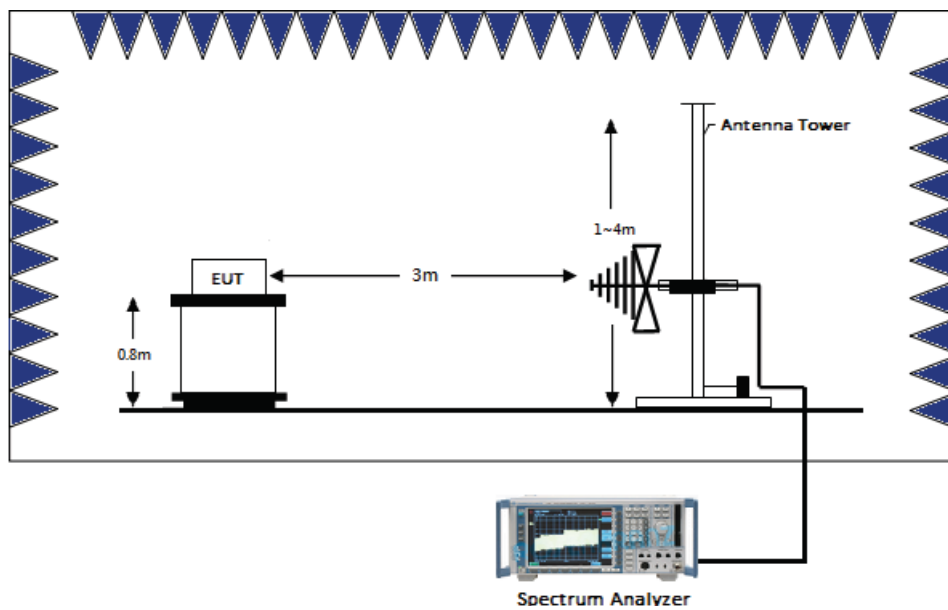

### 5.5.3 Radiated emission above 1GHz using Horn Antenna

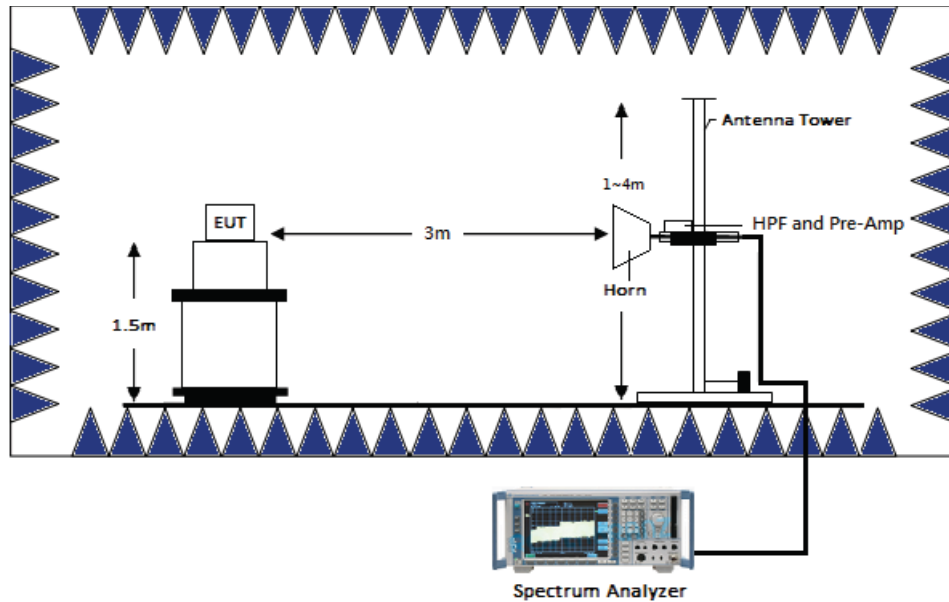

### 5.6 Test results

#### 5.6.1 Measurement results: frequencies from 9 kHz to 30MHz

Frequency (MHz)	Detection value	Factor (dB/m)	Reading (dBμV)	Value (dBμV/m)	Limit @ 3m (dBμV/m)	Tolerance (dB)
0.02	PK	19.26	28.13	47.39	121.58	-74.19
0.06	PK	18.95	27.21	46.16	112.04	-65.88
0.07	PK	18.94	27.24	46.18	110.70	-64.52
0.09	QP	18.77	24.65	43.42	108.52	-65.10
0.11	PK	18.74	20.58	39.32	106.78	-67.46
0.13	PK	18.74	20.83	39.57	105.33	-65.76
0.15	PK	18.73	31.88	50.61	104.08	-53.47
0.33	PK	18.75	34.75	53.50	97.23	-43.73
0.57	QP	18.63	36.23	54.86	72.49	-17.63
0.87	QP	18.61	31.09	49.70	68.81	-19.11
1.22	QP	18.59	29.81	48.40	65.88	-17.48
1.76	QP	18.54	25.91	44.45	69.54	-25.09

Remark: Corr. Factor = Antenna Factor + Cable Loss - PreAmplifier Gain

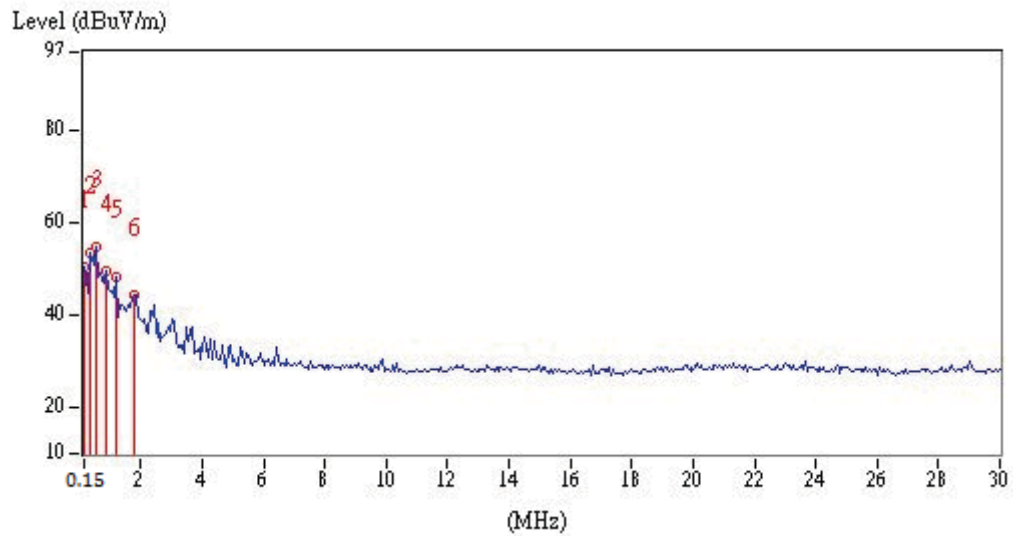
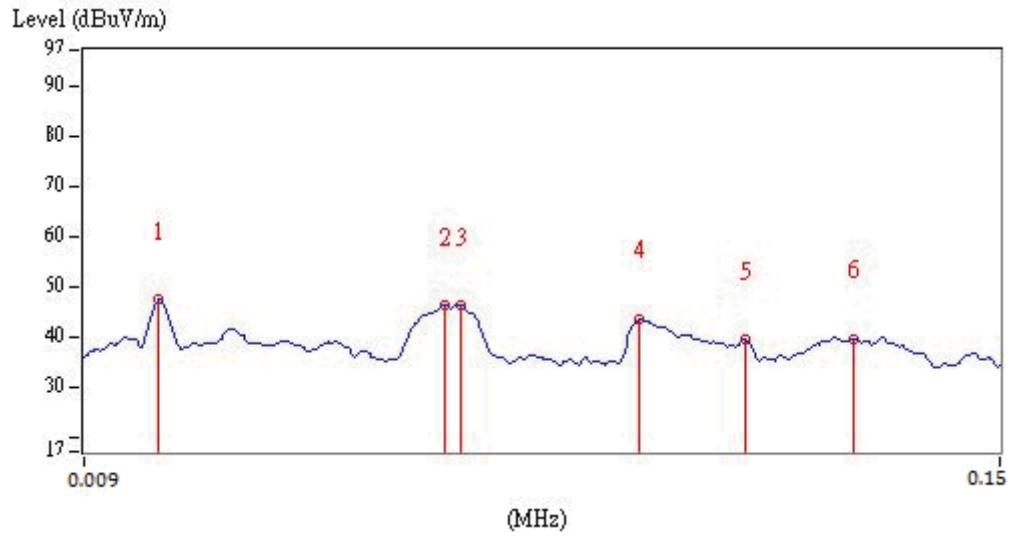

**TEST REPORT**

**5.6.2 Measurement results: frequencies from 30 MHz to 1GHz**

The test was performed on EUT under 802.11a/an continuously transmitting mode. The worst case occurred at 802.11a Tx channel 36.

Antenna Polariz. (V/H)	Freq. (MHz)	Receiver Detector	Corr. Factor (dB/m)	Reading (dBuV)	Corrected Level (dBuV/m)	Limit @ 3 m (dBuV/m)	Margin (dB)
Vertical	39.70	QP	12.72	16.49	29.21	40.00	-10.79
Vertical	130.88	QP	13.83	18.22	32.05	43.50	-11.45
Vertical	392.78	QP	18.22	18.66	36.88	46.00	-9.12
Vertical	598.42	QP	23.50	14.54	38.04	46.00	-7.96
Vertical	747.80	QP	26.15	18.18	44.33	46.00	-1.67
Vertical	823.46	QP	26.96	11.88	38.84	46.00	-7.16
Horizontal	154.16	QP	14.71	19.89	34.60	43.50	-8.90
Horizontal	224.00	QP	12.67	25.98	38.65	46.00	-7.35
Horizontal	311.30	QP	16.10	20.11	36.21	46.00	-9.79
Horizontal	379.20	QP	17.81	14.27	32.08	46.00	-13.92
Horizontal	598.42	QP	23.50	11.24	34.74	46.00	-11.26
Horizontal	747.80	QP	26.15	14.13	40.28	46.00	-5.72

Remark:

1. Corr. Factor = Antenna Factor + Cable Loss
2. Corrected Level = Reading + Corr. Factor

## Vertical

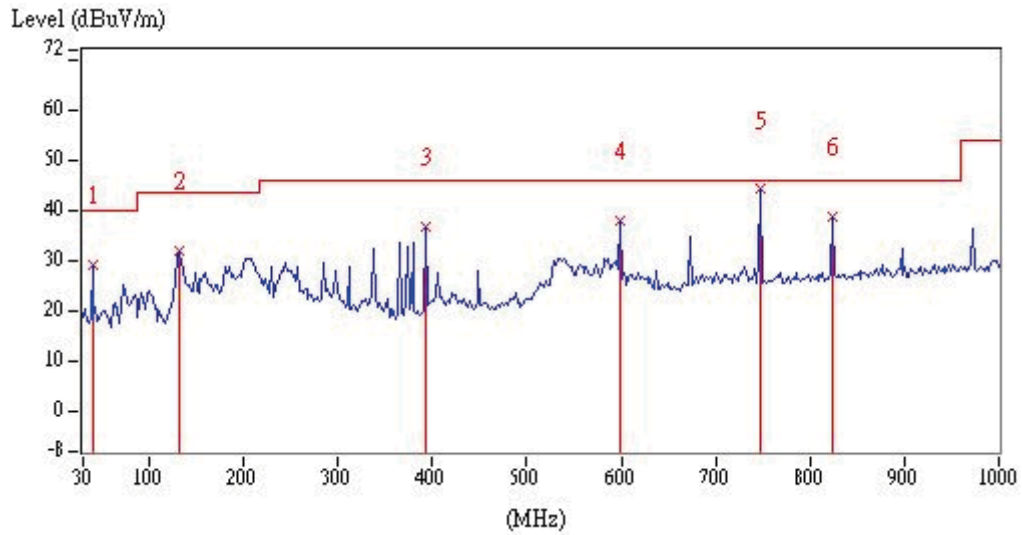

## Horizontal

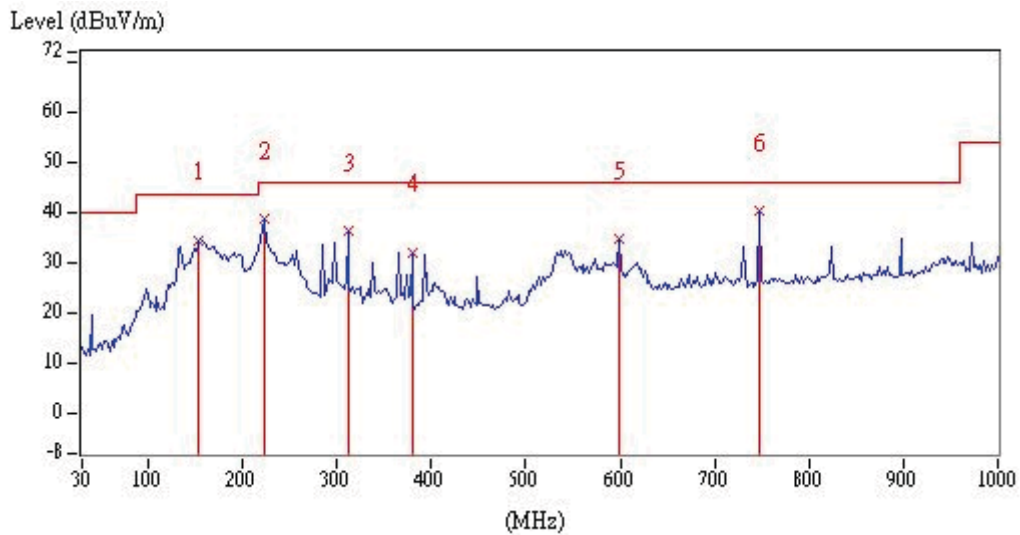



5.6.3 Measurement results: frequency above 1GHz to 40GHz

Chain0

Mode	Frequency (MHz)	Spectrum Analyzer Detector	Ant. Pol. (H/V)	Preamp. Gain (dB)	Correction Factor (dB/m)	Reading (dBμV)	Corrected Reading (dBμV/m)	Limit @ 3 m (dBμV/m)	Margin (dB)
802.11a_Ch36	1187	PK	H	37.29	-7.87	50.84	42.97	74.00	-31.03
	1946	PK	H	37.37	-2.07	50.91	48.83	74.00	-25.17
	2386	PK	H	37.37	-2.00	46.98	44.98	74.00	-29.02
	2771	PK	H	37.41	-0.74	42.07	41.33	74.00	-32.67
	3816	PK	H	37.28	2.27	39.67	41.94	74.00	-32.06
	10360	PK	H	35.77	19.98	25.48	45.47	74.00	-28.53
	1264	PK	V	37.31	-7.75	47.83	40.08	74.00	-33.92
	2386	PK	V	37.37	-2.00	45.45	43.45	74.00	-30.55
	2837	PK	V	37.42	-0.39	43.06	42.67	74.00	-31.33
	4036	PK	V	37.25	3.00	42.04	45.04	74.00	-28.96
	5334	PK	V	37.01	5.78	41.62	47.41	74.00	-26.59
	6159	PK	V	36.84	7.99	37.84	45.82	74.00	-28.18
	10360	PK	V	35.77	0.00	44.95	44.95	74.00	-29.05
802.11a_Ch44	1187	PK	H	37.29	-7.87	50.00	42.13	74.00	-31.87
	1341	PK	H	37.33	-7.63	50.31	42.68	74.00	-31.32
	1935	PK	H	37.37	-2.20	48.04	45.84	74.00	-28.16
	2386	PK	H	37.37	-2.00	43.86	41.86	74.00	-32.14
	3365	PK	H	37.37	0.96	42.74	43.7	74.00	-30.30
	10440	PK	H	35.73	20.49	25.89	46.38	74.00	-27.62
	1341	PK	V	37.33	-7.63	48.76	41.14	74.00	-32.86
	2320	PK	V	37.37	-1.90	44.01	42.1	74.00	-31.90
	2837	PK	V	37.42	-0.39	47.44	47.05	74.00	-26.95
	3365	PK	V	37.37	0.96	43.20	44.16	74.00	-29.84
10440	PK	V	35.73	20.49	26.07	46.56	74.00	-27.44	
802.11a_Ch48	1341	PK	H	37.33	-7.63	51.16	43.53	74.00	-30.47
	1935	PK	H	37.37	-2.20	45.92	43.72	74.00	-30.28
	2166	PK	H	37.37	-1.68	45.58	43.91	74.00	-30.09
	2837	PK	H	37.42	-0.39	45.44	45.04	74.00	-28.96
	10480	PK	H	35.71	20.75	26.27	47.02	74.00	-26.98
	1187	PK	V	37.29	-7.87	50.77	42.9	74.00	-31.10
	2012	PK	V	37.37	-1.45	43.73	42.28	74.00	-31.72
	2837	PK	V	37.42	-0.39	41.63	41.23	74.00	-32.77
10480	PK	V	35.71	20.75	26.46	47.2	74.00	-26.80	

Remark: Correction Factor = Antenna Factor + Cable Loss + High Pass Filter Loss - Pre\_Amplifier Gain

Chain0

Mode	Frequency (MHz)	Spectrum Analyzer Detector	Ant. Pol. (H/V)	Preamp. Gain (dB)	Correction Factor (dB/m)	Reading (dBμV)	Corrected Reading (dBμV/m)	Limit @ 3 m (dBμV/m)	Margin (dB)
802.11a_Ch52	1341	PK	H	37.33	-7.63	48.30	40.67	74.00	-33.33
	1946	PK	H	37.37	-2.07	43.82	41.75	74.00	-32.25
	3365	PK	H	37.37	0.96	42.89	43.85	74.00	-30.15
	10520	PK	H	35.7	20.95	25.51	46.45	74.00	-27.55
	1341	PK	V	37.33	-7.63	48.17	40.54	74.00	-33.46
	1737	PK	V	37.37	-4.56	46.40	41.84	74.00	-32.16
	2320	PK	V	37.37	-1.90	45.93	44.03	74.00	-29.97
	3365	PK	V	37.37	0.96	44.75	45.71	74.00	-28.29
	10520	PK	V	35.7	20.95	25.39	46.33	74.00	-27.67
802.11a_Ch60	1187	PK	H	37.29	-7.87	49.11	41.24	74.00	-32.76
	1946	PK	H	37.37	-2.07	43.27	41.2	74.00	-32.80
	3585	PK	H	37.32	1.45	41.50	42.95	74.00	-31.05
	10600	PK	H	35.71	21.24	23.34	44.58	74.00	-29.42
	1187	PK	V	37.29	-7.87	51.23	43.36	74.00	-30.64
	2617	PK	V	37.39	-1.55	43.59	42.04	74.00	-31.96
	3365	PK	V	37.37	0.96	43.02	43.99	74.00	-30.01
	10600	PK	V	35.71	21.24	25.38	46.62	74.00	-27.38
802.11a_Ch64	1187	PK	H	37.29	-7.87	50.96	43.09	74.00	-30.91
	1946	PK	H	37.37	-2.07	48.54	46.46	74.00	-27.54
	3442	PK	H	37.35	1.07	42.70	43.77	74.00	-30.23
	10640	PK	H	35.71	21.39	24.21	45.6	74.00	-28.40
	1341	PK	V	37.33	-7.63	47.09	39.46	74.00	-34.54
	1935	PK	V	37.37	-2.20	45.54	43.34	74.00	-30.66
	2386	PK	V	37.37	-2.00	45.15	43.14	74.00	-30.86
	3365	PK	V	37.37	0.96	45.71	46.67	74.00	-27.33
	10640	PK	V	35.71	21.39	24.70	46.09	74.00	-27.91

Remark: Correction Factor = Antenna Factor + Cable Loss + High Pass Filter Loss - Pre\_Amplifier Gain

## TEST REPORT

Mode	Frequency (MHz)	Spectrum Analyzer Detector	Ant. Pol. (H/V)	Preamp. Gain (dB)	Correction Factor (dB/m)	Reading (dBμV)	Corrected Reading (dBμV/m)	Limit @ 3 m (dBμV/m)	Margin (dB)
802.11a_Ch100	1341	PK	H	37.33	-7.63	48.89	41.27	74.00	-32.73
	1946	PK	H	37.37	-2.07	45.01	42.94	74.00	-31.06
	2386	PK	H	37.37	-2.00	43.54	41.54	74.00	-32.46
	3442	PK	H	37.35	1.07	46.10	47.17	74.00	-26.83
	11000	PK	H	35.73	22.71	25.69	48.4	74.00	-25.60
	1341	PK	V	37.33	-7.63	50.90	43.27	74.00	-30.73
	1935	PK	V	37.37	-2.20	43.85	41.65	74.00	-32.35
	2320	PK	V	37.37	-1.90	45.04	43.14	74.00	-30.86
	2760	PK	V	37.41	-0.80	42.83	42.04	74.00	-31.96
	3442	PK	V	37.35	1.07	41.96	43.03	74.00	-30.97
11000	PK	V	35.73	22.71	25.18	47.9	74.00	-26.10	
802.11a_Ch120	1341	PK	H	37.33	-7.63	48.96	41.33	74.00	-32.67
	1935	PK	H	37.37	-2.20	45.64	43.44	74.00	-30.56
	2386	PK	H	37.37	-2.00	44.24	42.24	74.00	-31.76
	3442	PK	H	37.35	1.07	41.86	42.92	74.00	-31.08
	11200	PK	H	35.74	22.82	24.64	47.45	74.00	-26.55
	1341	PK	V	37.33	-7.63	49.50	41.88	74.00	-32.12
	1935	PK	V	37.37	-2.20	45.43	43.22	74.00	-30.78
	2386	PK	V	37.37	-2.00	44.58	42.58	74.00	-31.42
	11200	PK	V	35.74	22.82	24.92	47.74	74.00	-26.26
802.11a_Ch140	1187	PK	H	37.29	-7.87	49.43	41.56	74.00	-32.44
	1946	PK	H	37.37	-2.07	44.24	42.17	74.00	-31.83
	2386	PK	H	37.37	-2.00	45.59	43.59	74.00	-30.41
	3585	PK	H	37.32	1.45	42.43	43.88	74.00	-30.12
	11400	PK	H	35.75	22.92	24.56	47.48	74.00	-26.52
	1341	PK	V	37.33	-7.63	48.25	40.62	74.00	-33.38
	1726	PK	V	37.37	-4.69	46.34	41.65	74.00	-32.35
	1946	PK	V	37.37	-2.07	45.60	43.52	74.00	-30.48
	3442	PK	V	37.35	1.07	46.12	47.19	74.00	-26.81
	4036	PK	V	37.25	3.00	42.94	45.94	74.00	-28.06
11400	PK	V	35.75	22.92	24.76	47.68	74.00	-26.32	

Remark: Correction Factor = Antenna Factor + Cable Loss + High Pass Filter Loss - Pre\_Amplifier Gain

**TEST REPORT**

**Chain0**

Mode	Frequency (MHz)	Spectrum Analyzer Detector	Ant. Pol. (H/V)	Preamp. Gain (dB)	Correction Factor (dB/m)	Reading (dBμV)	Corrected Reading (dBμV/m)	Limit @ 3 m (dBμV/m)	Margin (dB)
802.11a_Ch149	1341	PK	H	37.33	-7.63	49.61	41.98	74.00	-32.02
	1946	PK	H	37.37	-2.07	47.82	45.74	74.00	-28.26
	2760	PK	H	37.41	-0.80	44.02	43.22	74.00	-30.78
	11490	PK	H	35.76	22.97	24.79	47.76	74.00	-26.24
	1341	PK	V	37.33	-7.63	52.20	44.57	74.00	-29.43
	2353	PK	V	37.37	-1.95	49.56	47.61	74.00	-26.39
	3365	PK	V	37.37	0.96	45.32	46.29	74.00	-27.71
	11490	PK	V	35.76	22.97	24.01	46.97	74.00	-27.03
802.11a_Ch157	1341	PK	H	37.33	-7.63	49.60	41.97	74.00	-32.03
	1946	PK	H	37.37	-2.07	45.64	43.57	74.00	-30.43
	2760	PK	H	37.41	-0.80	43.21	42.41	74.00	-31.59
	11570	PK	H	35.74	22.87	23.84	46.72	74.00	-27.28
	1264	PK	V	37.31	-7.75	50.58	42.83	74.00	-31.17
	1869	PK	V	37.37	-2.99	47.64	44.65	74.00	-29.35
	2309	PK	V	37.37	-1.89	48.17	46.28	74.00	-27.72
	11570	PK	V	35.74	22.87	23.97	46.84	74.00	-27.16
802.11a_Ch165	1341	PK	H	37.33	-7.63	49.20	41.57	74.00	-32.43
	1946	PK	H	37.37	-2.07	47.26	45.19	74.00	-28.81
	2463	PK	H	37.37	-2.11	46.15	44.03	74.00	-29.97
	11650	PK	H	35.72	22.76	24.07	46.83	74.00	-27.17
	1341	PK	V	37.33	-7.63	50.28	42.65	74.00	-31.35
	2353	PK	V	37.37	-1.95	47.17	45.22	74.00	-28.78
	3365	PK	V	37.37	0.96	43.19	44.15	74.00	-29.85
	11650	PK	V	35.72	22.76	24.28	47.04	74.00	-26.96

Remark: Correction Factor = Antenna Factor + Cable Loss + High Pass Filter Loss - Pre\_Amplifier Gain

**TEST REPORT**

**Chain1**

Mode	Frequency (MHz)	Spectrum Analyzer Detector	Ant. Pol. (H/V)	Preamp. Gain (dB)	Correction Factor (dB/m)	Reading (dBμV)	Corrected Reading (dBμV/m)	Limit @ 3 m (dBμV/m)	Margin (dB)
802.11a_Ch36	1187	PK	H	37.29	-7.87	48.71	40.84	74.00	-33.16
	2012	PK	H	37.37	-1.45	43.91	42.46	74.00	-31.54
	2386	PK	H	37.37	-2.00	45.27	43.27	74.00	-30.73
	3365	PK	H	37.37	0.96	41.92	42.88	74.00	-31.12
	10360	PK	H	35.77	19.98	25.47	45.46	74.00	-28.54
	1341	PK	V	37.33	-7.63	48.29	40.66	74.00	-33.34
	2012	PK	V	37.37	-1.45	43.78	42.34	74.00	-31.66
	2243	PK	V	37.37	-1.79	44.45	42.66	74.00	-31.34
	2914	PK	V	37.44	0.01	43.34	43.36	74.00	-30.64
	3365	PK	V	37.37	0.96	42.32	43.28	74.00	-30.72
10360	PK	V	35.77	19.98	25.37	45.35	74.00	-28.65	
802.11a_Ch44	1187	PK	H	37.29	-7.87	48.73	40.86	74.00	-33.14
	2012	PK	H	37.37	-1.45	45.53	44.08	74.00	-29.92
	2386	PK	H	37.37	-2.00	46.94	44.94	74.00	-29.06
	3442	PK	H	37.35	1.07	42.67	43.74	74.00	-30.26
	10440	PK	H	35.73	20.49	26.05	46.54	74.00	-27.46
	1341	PK	V	37.33	-7.63	45.80	38.17	74.00	-35.83
	1946	PK	V	37.37	-2.07	44.86	42.78	74.00	-31.22
	2386	PK	V	37.37	-2.00	45.84	43.84	74.00	-30.16
10440	PK	V	35.73	20.49	26.11	46.61	74.00	-27.39	
802.11a_Ch48	1187	PK	H	37.29	-7.87	48.29	40.42	74.00	-33.58
	1869	PK	H	37.37	-2.99	45.66	42.67	74.00	-31.33
	2386	PK	H	37.37	-2.00	45.28	43.27	74.00	-30.73
	10480	PK	H	35.71	20.75	25.40	46.15	74.00	-27.85
	1341	PK	V	37.33	-7.63	46.28	38.65	74.00	-35.35
	2320	PK	V	37.37	-1.90	45.96	44.06	74.00	-29.94
	2914	PK	V	37.44	0.01	47.27	47.29	74.00	-26.71
	3365	PK	V	37.37	0.96	42.16	43.12	74.00	-30.88
10480	PK	V	35.71	20.75	26.79	47.53	74.00	-26.47	

Remark: Correction Factor = Antenna Factor + Cable Loss + High Pass Filter Loss - Pre\_Amplifier Gain

## TEST REPORT

### Chain1

Mode	Frequency (MHz)	Spectrum Analyzer Detector	Ant. Pol. (H/V)	Preamp. Gain (dB)	Correction Factor (dB/m)	Reading (dBμV)	Corrected Reading (dBμV/m)	Limit @ 3 m (dBμV/m)	Margin (dB)
802.11a_Ch52	1187	PK	H	37.29	-7.87	48.84	40.97	74.00	-33.03
	1946	PK	H	37.37	-2.07	46.13	44.05	74.00	-29.95
	2386	PK	H	37.37	-2.00	45.85	43.85	74.00	-30.15
	3442	PK	H	37.35	1.07	42.51	43.58	74.00	-30.42
	10520	PK	H	35.7	20.95	25.59	46.54	74.00	-27.46
	1341	PK	V	37.33	-7.63	46.85	39.23	74.00	-34.77
	1792	PK	V	37.37	-3.90	44.02	40.12	74.00	-33.88
	3365	PK	V	37.37	0.96	41.74	42.7	74.00	-31.30
	10520	PK	V	35.7	20.95	25.26	46.2	74.00	-27.80
802.11a_Ch60	1187	PK	H	37.29	-7.87	50.21	42.34	74.00	-31.66
	2012	PK	H	37.37	-1.45	47.91	46.46	74.00	-27.54
	2463	PK	H	37.37	-2.11	45.97	43.85	74.00	-30.15
	3585	PK	H	37.32	1.45	41.61	43.06	74.00	-30.94
	10600	PK	H	35.71	21.24	24.43	45.67	74.00	-28.33
	1341	PK	V	37.33	-7.63	46.83	39.21	74.00	-34.79
	2320	PK	V	37.37	-1.90	45.20	43.29	74.00	-30.71
	3365	PK	V	37.37	0.96	45.20	46.16	74.00	-27.84
	10600	PK	V	35.71	21.24	24.86	46.1	74.00	-27.90
802.11a_Ch64	1187	PK	H	37.29	-7.87	50.73	42.86	74.00	-31.14
	1946	PK	H	37.37	-2.07	46.77	44.69	74.00	-29.31
	2463	PK	H	37.37	-2.11	46.61	44.49	74.00	-29.51
	10640	PK	H	35.71	21.39	24.07	45.46	74.00	-28.54
	1341	PK	V	37.33	-7.63	48.58	40.96	74.00	-33.04
	1715	PK	V	37.37	-4.82	46.10	41.28	74.00	-32.72
	2320	PK	V	37.37	-1.90	46.08	44.17	74.00	-29.83
	3959	PK	V	37.26	2.78	41.64	44.42	74.00	-29.58
	10640	PK	V	35.71	21.39	24.49	45.87	74.00	-28.13

Remark: Correction Factor = Antenna Factor + Cable Loss + High Pass Filter Loss - Pre\_Amplifier Gain

## TEST REPORT

### Chain1

Mode	Frequency (MHz)	Spectrum Analyzer Detector	Ant. Pol. (H/V)	Preamp. Gain (dB)	Correction Factor (dB/m)	Reading (dBμV)	Corrected Reading (dBμV/m)	Limit @ 3 m (dBμV/m)	Margin (dB)
802.11a_Ch100	1187	PK	H	37.29	-7.87	48.90	41.03	74.00	-32.97
	1935	PK	H	37.37	-2.20	42.68	40.47	74.00	-33.53
	2386	PK	H	37.37	-2.00	45.77	43.77	74.00	-30.23
	3585	PK	H	37.32	1.45	42.31	43.76	74.00	-30.24
	11000	PK	H	35.73	22.71	25.61	48.32	74.00	-25.68
	1341	PK	V	37.33	-7.63	48.10	40.47	74.00	-33.53
	1737	PK	V	37.37	-4.56	46.17	41.61	74.00	-32.39
	1935	PK	V	37.37	-2.20	46.27	44.07	74.00	-29.93
	2463	PK	V	37.37	-2.11	43.65	41.54	74.00	-32.46
	11000	PK	V	35.73	22.71	24.89	47.6	74.00	-26.40
802.11a_Ch120	1341	PK	H	37.33	-7.63	47.59	39.96	74.00	-34.04
	1946	PK	H	37.37	-2.07	49.12	47.05	74.00	-26.95
	2386	PK	H	37.37	-2.00	45.74	43.74	74.00	-30.26
	3365	PK	H	37.37	0.96	42.41	43.37	74.00	-30.63
	11200	PK	H	35.74	22.82	25.18	48	74.00	-26.00
	1341	PK	V	37.33	-7.63	49.06	41.43	74.00	-32.57
	1869	PK	V	37.37	-2.99	44.60	41.61	74.00	-32.39
	2760	PK	V	37.41	-0.80	43.52	42.72	74.00	-31.28
	3365	PK	V	37.37	0.96	42.13	43.09	74.00	-30.91
	11200	PK	V	35.74	22.82	24.62	47.43	74.00	-26.57
802.11a_Ch140	1341	PK	H	37.33	-7.63	48.10	40.47	74.00	-33.53
	1935	PK	H	37.37	-2.20	45.94	43.74	74.00	-30.26
	3365	PK	H	37.37	0.96	43.26	44.22	74.00	-29.78
	11400	PK	H	35.75	22.92	24.38	47.3	74.00	-26.70
	1341	PK	V	37.33	-7.63	50.81	43.18	74.00	-30.82
	1869	PK	V	37.37	-2.99	44.90	41.91	74.00	-32.09
	2320	PK	V	37.37	-1.90	43.46	41.56	74.00	-32.44
	3365	PK	V	37.37	0.96	44.84	45.8	74.00	-28.20
	4036	PK	V	37.25	3.00	43.17	46.17	74.00	-27.83
	11400	PK	V	35.75	22.92	24.57	47.49	74.00	-26.51

Remark: Correction Factor = Antenna Factor + Cable Loss + High Pass Filter Loss - Pre\_Amplifier Gain

## TEST REPORT

### Chain1

Mode	Frequency (MHz)	Spectrum Analyzer Detector	Ant. Pol. (H/V)	Preamp. Gain (dB)	Correction Factor (dB/m)	Reading (dBμV)	Corrected Reading (dBμV/m)	Limit @ 3 m (dBμV/m)	Margin (dB)
802.11a_Ch149	1341	PK	H	37.33	-7.63	49.83	42.21	74.00	-31.79
	1946	PK	H	37.37	-2.07	45.09	43.02	74.00	-30.98
	2386	PK	H	37.37	-2.00	44.14	42.14	74.00	-31.86
	3442	PK	H	37.35	1.07	45.55	46.62	74.00	-27.38
	11490	PK	H	35.76	22.97	24.49	47.46	74.00	-26.54
	1341	PK	V	37.33	-7.63	50.57	42.94	74.00	-31.06
	2012	PK	V	37.37	-1.45	43.68	42.23	74.00	-31.77
	2375	PK	V	37.37	-1.98	49.02	47.03	74.00	-26.97
	11490	PK	V	35.76	22.97	25.34	48.31	74.00	-25.69
802.11a_Ch157	1341	PK	H	37.33	-7.63	52.59	44.96	74.00	-29.04
	1946	PK	H	37.37	-2.07	46.52	44.45	74.00	-29.55
	2320	PK	H	37.37	-1.90	47.84	45.94	74.00	-28.06
	11570	PK	H	35.74	22.87	24.25	47.12	74.00	-26.88
	1341	PK	V	37.33	-7.63	50.78	43.15	74.00	-30.85
	2309	PK	V	37.37	-1.89	48.78	46.89	74.00	-27.11
	3365	PK	V	37.37	0.96	43.39	44.35	74.00	-29.65
	11570	PK	V	35.74	22.87	23.01	45.88	74.00	-28.12
802.11a_Ch165	1341	PK	H	37.33	-7.63	52.11	44.48	74.00	-29.52
	1946	PK	H	37.37	-2.07	50.48	48.41	74.00	-25.59
	2386	PK	H	37.37	-2.00	44.12	42.12	74.00	-31.88
	3585	PK	H	37.32	1.45	41.43	42.88	74.00	-31.12
	11650	PK	H	35.72	22.76	24.58	47.34	74.00	-26.66
	1341	PK	V	37.33	-7.63	51.13	43.51	74.00	-30.49
	2309	PK	V	37.37	-1.89	43.95	42.06	74.00	-31.94
	2760	PK	V	37.41	-0.80	42.83	42.03	74.00	-31.97
	11650	PK	V	35.72	22.76	22.65	45.41	74.00	-28.59

Remark: Correction Factor = Antenna Factor + Cable Loss + High Pass Filter Loss - Pre\_Amplifier Gain



**TEST REPORT**

**Chain0+1**

Mode	Frequency (MHz)	Spectrum Analyzer Detector	Ant. Pol. (H/V)	Preamp. Gain (dB)	Correction Factor (dB/m)	Reading (dBμV)	Corrected Reading (dBμV/m)	Limit @ 3 m (dBμV/m)	Margin (dB)
802.11ac (VHT20) Ch36	1187	PK	H	37.29	-7.87	52.19	44.32	74.00	-29.68
	1946	PK	H	37.37	-2.07	46.31	44.24	74.00	-29.76
	2012	PK	H	37.37	-1.45	45.62	44.17	74.00	-29.83
	2694	PK	H	37.4	-1.15	44.01	42.86	74.00	-31.14
	3365	PK	H	37.37	0.96	42.51	43.47	74.00	-30.53
	4036	PK	H	37.25	3.00	40.91	43.91	74.00	-30.09
	10360	PK	H	35.77	19.98	24.96	44.94	74.00	-29.06
	1341	PK	V	37.33	-7.63	52.15	44.52	74.00	-29.48
	1935	PK	V	37.37	-2.20	44.37	42.16	74.00	-31.84
	2331	PK	V	37.37	-1.92	46.39	44.47	74.00	-29.53
	2837	PK	V	37.42	-0.39	45.36	44.97	74.00	-29.03
	3442	PK	V	37.35	1.07	45.44	46.51	74.00	-27.49
	6159	PK	V	36.84	7.99	40.21	48.2	74.00	-25.80
	10360	PK	V	35.77	19.98	25.52	45.5	74.00	-28.50
802.11ac (VHT20) Ch44	1187	PK	H	37.29	-7.87	49.67	41.8	74.00	-32.20
	2012	PK	H	37.37	-1.45	47.11	45.66	74.00	-28.34
	2386	PK	H	37.37	-2.00	46.14	44.14	74.00	-29.86
	2914	PK	H	37.44	0.01	44.94	44.96	74.00	-29.04
	10440	PK	H	35.73	20.49	26.08	46.57	74.00	-27.43
	1341	PK	V	37.33	-7.63	45.98	38.36	74.00	-35.64
	2320	PK	V	37.37	-1.90	45.64	43.74	74.00	-30.26
	3629	PK	V	37.32	1.61	41.98	43.59	74.00	-30.41
	6236	PK	V	36.82	8.25	40.34	48.58	74.00	-25.42
	10440	PK	V	35.73	20.49	26.18	46.67	74.00	-27.33
802.11ac (VHT20) Ch48	1187	PK	H	37.29	-7.87	49.97	42.1	74.00	-31.90
	2012	PK	H	37.37	-1.45	43.91	42.46	74.00	-31.54
	2166	PK	H	37.37	-1.68	45.61	43.94	74.00	-30.06
	2914	PK	H	37.44	0.01	43.93	43.94	74.00	-30.06
	10480	PK	H	35.71	20.75	26.30	47.04	74.00	-26.96
	1187	PK	V	37.29	-7.87	48.43	40.56	74.00	-33.44
	1946	PK	V	37.37	-2.07	44.61	42.54	74.00	-31.46
	2210	PK	V	37.37	-1.74	44.52	42.78	74.00	-31.22
	3365	PK	V	37.37	0.96	42.89	43.85	74.00	-30.15
	3959	PK	V	37.26	2.78	42.05	44.84	74.00	-29.16
	6280	PK	V	36.8	8.39	38.18	46.57	74.00	-27.43
	10480	PK	V	35.71	20.75	27.00	47.74	74.00	-26.26

**TEST REPORT**

**Chain0+1**

Mode	Frequency (MHz)	Spectrum Analyzer Detector	Ant. Pol. (H/V)	Preamp. Gain (dB)	Correction Factor (dB/m)	Reading (dBμV)	Corrected Reading (dBμV/m)	Limit @ 3 m (dBμV/m)	Margin (dB)
802.11ac (VHT20) Ch52	1187	PK	H	37.29	-7.87	50.10	42.24	74.00	-31.76
	1869	PK	H	37.37	-2.99	46.47	43.48	74.00	-30.52
	2463	PK	H	37.37	-2.11	44.05	41.94	74.00	-32.06
	10520	PK	H	35.7	20.95	25.88	46.83	74.00	-27.17
	1341	PK	V	37.33	-7.63	49.90	42.28	74.00	-31.72
	2012	PK	V	37.37	-1.45	42.60	41.15	74.00	-32.85
	3365	PK	V	37.37	0.96	44.78	45.75	74.00	-28.25
	10520	PK	V	35.7	20.95	26.01	46.96	74.00	-27.04
802.11ac (VHT20) Ch60	1341	PK	H	37.33	-7.63	47.94	40.31	74.00	-33.69
	1946	PK	H	37.37	-2.07	45.76	43.69	74.00	-30.31
	2694	PK	H	37.4	-1.15	44.09	42.94	74.00	-31.06
	10600	PK	H	35.71	21.24	24.38	45.62	74.00	-28.38
	1187	PK	V	37.29	-7.87	49.21	41.35	74.00	-32.65
	1792	PK	V	37.37	-3.90	45.32	41.42	74.00	-32.58
	3365	PK	V	37.37	0.96	42.69	43.66	74.00	-30.34
	10600	PK	V	35.71	21.24	23.82	45.06	74.00	-28.94
802.11ac (VHT20) Ch64	1187	PK	H	37.29	-7.87	49.28	41.41	74.00	-32.59
	1506	PK	H	37.37	-7.31	52.57	45.26	74.00	-28.74
	1946	PK	H	37.37	-2.07	43.25	41.18	74.00	-32.82
	3585	PK	H	37.32	1.45	41.64	43.09	74.00	-30.91
	10640	PK	H	35.71	21.39	24.32	45.71	74.00	-28.29
	1341	PK	V	37.33	-7.63	48.19	40.56	74.00	-33.44
	2298	PK	V	37.37	-1.87	43.67	41.8	74.00	-32.20
	3365	PK	V	37.37	0.96	39.98	40.94	74.00	-33.06
	10640	PK	V	35.71	21.39	24.11	45.5	74.00	-28.50
802.11ac (VHT20) Ch100	1341	PK	H	37.33	-7.63	47.88	40.26	74.00	-33.74
	1935	PK	H	37.37	-2.20	48.21	46	74.00	-28.00
	2320	PK	H	37.37	-1.90	46.11	44.2	74.00	-29.80
	11000	PK	H	35.73	22.71	25.34	48.05	74.00	-25.95
	1341	PK	V	37.33	-7.63	48.27	40.64	74.00	-33.36
	2386	PK	V	37.37	-2.00	45.40	43.4	74.00	-30.60
	3442	PK	V	37.35	1.07	42.36	43.42	74.00	-30.58
	11000	PK	V	35.73	22.71	24.81	47.52	74.00	-26.48

Remark: Correction Factor = Antenna Factor + Cable Loss + High Pass Filter Loss - Pre\_Amplifier Gain

**TEST REPORT**

**Chain0+1**

Mode	Frequency (MHz)	Spectrum Analyzer Detector	Ant. Pol. (H/V)	Preamp. Gain (dB)	Correction Factor (dB/m)	Reading (dBμV)	Corrected Reading (dBμV/m)	Limit @ 3 m (dBμV/m)	Margin (dB)
802.11ac (VHT20) Ch120	1341	PK	H	37.33	-7.63	48.53	40.9	74.00	-33.10
	1946	PK	H	37.37	-2.07	50.98	48.91	74.00	-25.09
	2617	PK	H	37.39	-1.55	44.55	43	74.00	-31.00
	11200	PK	H	35.74	22.82	24.81	47.63	74.00	-26.37
	1341	PK	V	37.33	-7.63	48.64	41.01	74.00	-32.99
	1946	PK	V	37.37	-2.07	47.75	45.67	74.00	-28.33
	3365	PK	V	37.37	0.96	42.07	43.03	74.00	-30.97
	11200	PK	V	35.74	22.82	24.83	47.64	74.00	-26.36
802.11ac (VHT20) Ch140	1341	PK	H	37.33	-7.63	46.92	39.29	74.00	-34.71
	1946	PK	H	37.37	-2.07	43.73	41.65	74.00	-32.35
	2320	PK	H	37.37	-1.90	44.11	42.21	74.00	-31.79
	3585	PK	H	37.32	1.45	41.71	43.16	74.00	-30.84
	11400	PK	H	35.75	22.92	25.32	48.24	74.00	-25.76
	1341	PK	V	37.33	-7.63	50.83	43.21	74.00	-30.79
	1869	PK	V	37.37	-2.99	46.33	43.34	74.00	-30.66
	2397	PK	V	37.37	-2.02	45.48	43.46	74.00	-30.54
	2760	PK	V	37.41	-0.80	43.34	42.54	74.00	-31.46
	11400	PK	V	35.75	22.92	24.55	47.47	74.00	-26.53
802.11ac (VHT20) Ch149	1187	PK	H	37.29	-7.87	50.74	42.87	74.00	-31.13
	1869	PK	H	37.37	-2.99	46.88	43.9	74.00	-30.10
	2386	PK	H	37.37	-2.00	44.32	42.32	74.00	-31.68
	11490	PK	H	35.76	22.97	23.70	46.67	74.00	-27.33
	1187	PK	V	37.29	-7.87	50.67	42.81	74.00	-31.19
	2012	PK	V	37.37	-1.45	43.54	42.09	74.00	-31.91
	2375	PK	V	37.37	-1.98	46.31	44.33	74.00	-29.67
	11490	PK	V	35.76	22.97	24.51	47.48	74.00	-26.52
802.11ac (VHT20) Ch157	1341	PK	H	37.33	-7.63	49.79	42.17	74.00	-31.83
	1869	PK	H	37.37	-2.99	46.31	43.32	74.00	-30.68
	2760	PK	H	37.41	-0.80	44.78	43.98	74.00	-30.02
	3288	PK	H	37.39	0.86	44.16	45.01	74.00	-28.99
	11570	PK	H	35.74	22.87	23.70	46.58	74.00	-27.42
	1341	PK	V	37.33	-7.63	50.11	42.49	74.00	-31.51
	1935	PK	V	37.37	-2.20	44.84	42.64	74.00	-31.36
	2386	PK	V	37.37	-2.00	45.27	43.27	74.00	-30.73
	11570	PK	V	35.74	22.87	25.24	48.12	74.00	-25.88

Remark: Correction Factor = Antenna Factor + Cable Loss + High Pass Filter Loss - Pre\_Amplifier Gain

**TEST REPORT**

**Chain0+1**

Mode	Frequency (MHz)	Spectrum Analyzer Detector	Ant. Pol. (H/V)	Preamp. Gain (dB)	Correction Factor (dB/m)	Reading (dBμV)	Corrected Reading (dBμV/m)	Limit @ 3 m (dBμV/m)	Margin (dB)
802.11ac (VHT20) Ch165	1341	PK	H	37.33	-7.63	50.29	42.66	74.00	-31.34
	1869	PK	H	37.37	-2.99	46.46	43.47	74.00	-30.53
	2386	PK	H	37.37	-2.00	43.53	41.53	74.00	-32.47
	11650	PK	H	35.72	22.76	23.54	46.3	74.00	-27.70
	1341	PK	V	37.33	-7.63	51.34	43.71	74.00	-30.29
	2012	PK	V	37.37	-1.45	44.85	43.4	74.00	-30.60
	2342	PK	V	37.37	-1.94	45.93	44	74.00	-30.00
	3365	PK	V	37.37	0.96	43.30	44.26	74.00	-29.74
	4036	PK	V	37.25	3.00	41.39	44.39	74.00	-29.61
	11650	PK	V	35.72	22.76	23.41	46.17	74.00	-27.83
802.11ac (VHT40) Ch38	1187	PK	H	37.29	-7.87	47.97	40.11	74.00	-33.89
	2012	PK	H	37.37	-1.45	45.58	44.14	74.00	-29.86
	2914	PK	H	37.44	0.01	46.95	46.96	74.00	-27.04
	10380	PK	H	35.76	20.11	25.89	46	74.00	-28.00
	1341	PK	V	37.33	-7.63	50.59	42.96	74.00	-31.04
	1572	PK	V	37.37	-6.52	49.99	43.47	74.00	-30.53
	2012	PK	V	37.37	-1.45	44.62	43.18	74.00	-30.82
	2320	PK	V	37.37	-1.90	48.45	46.54	74.00	-27.46
	2837	PK	V	37.42	-0.39	45.19	44.8	74.00	-29.20
	3574	PK	V	37.33	1.41	43.74	45.15	74.00	-28.85
	6181	PK	V	36.83	8.06	40.14	48.21	74.00	-25.79
	10380	PK	V	35.76	20.11	25.80	45.91	74.00	-28.09
802.11ac (VHT40) Ch46	1341	PK	H	37.33	-7.63	52.28	44.66	74.00	-29.34
	1946	PK	H	37.37	-2.07	46.17	44.1	74.00	-29.90
	2166	PK	H	37.37	-1.68	43.81	42.13	74.00	-31.87
	10460	PK	H	35.72	20.62	25.43	46.05	74.00	-27.95
	1264	PK	V	37.31	-7.75	46.26	38.51	74.00	-35.49
	1770	PK	V	37.37	-4.17	44.04	39.87	74.00	-34.13
	2287	PK	V	37.37	-1.85	45.66	43.81	74.00	-30.19
	3365	PK	V	37.37	0.96	42.70	43.67	74.00	-30.33
	6258	PK	V	36.81	8.32	38.34	46.66	74.00	-27.34
	10460	PK	V	35.72	20.62	26.50	47.12	74.00	-26.88

Remark: Correction Factor = Antenna Factor + Cable Loss + High Pass Filter Loss - Pre\_Amplifier Gain

**TEST REPORT**

**Chain0+1**

Mode	Frequency (MHz)	Spectrum Analyzer Detector	Ant. Pol. (H/V)	Preamp. Gain (dB)	Correction Factor (dB/m)	Reading (dBμV)	Corrected Reading (dBμV/m)	Limit @ 3 m (dBμV/m)	Margin (dB)
802.11ac (VHT40) Ch54	1187	PK	H	37.29	-7.87	50.53	42.66	74.00	-31.34
	1946	PK	H	37.37	-2.07	46.73	44.66	74.00	-29.34
	2386	PK	H	37.37	-2.00	44.26	42.26	74.00	-31.74
	3585	PK	H	37.32	1.45	41.61	43.06	74.00	-30.94
	10540	PK	H	35.7	21.02	25.61	46.63	74.00	-27.37
	1187	PK	V	37.29	-7.87	51.02	43.16	74.00	-30.84
	2320	PK	V	37.37	-1.90	42.48	40.58	74.00	-33.42
	3365	PK	V	37.37	0.96	44.33	45.3	74.00	-28.70
	10540	PK	V	35.7	21.02	24.99	46.01	74.00	-27.99
802.11ac (VHT40) Ch62	1341	PK	H	37.33	-7.63	48.27	40.64	74.00	-33.36
	1869	PK	H	37.37	-2.99	45.32	42.33	74.00	-31.67
	2386	PK	H	37.37	-2.00	45.32	43.32	74.00	-30.68
	2694	PK	H	37.4	-1.15	43.41	42.26	74.00	-31.74
	10620	PK	H	35.71	21.31	23.92	45.24	74.00	-28.76
	1341	PK	V	37.33	-7.63	47.51	39.88	74.00	-34.12
	1946	PK	V	37.37	-2.07	45.41	43.34	74.00	-30.66
	2386	PK	V	37.37	-2.00	47.19	45.19	74.00	-28.81
	3365	PK	V	37.37	0.96	44.87	45.84	74.00	-28.16
	10620	PK	V	35.71	21.31	24.48	45.79	74.00	-28.21
802.11ac (VHT40) Ch102	1187	PK	H	37.29	-7.87	49.29	41.43	74.00	-32.57
	1946	PK	H	37.37	-2.07	45.08	43.01	74.00	-30.99
	3585	PK	H	37.32	1.45	41.43	42.88	74.00	-31.12
	11020	PK	H	35.73	22.72	24.43	47.16	74.00	-26.84
	1506	PK	V	37.37	-7.31	49.58	42.27	74.00	-31.73
	1935	PK	V	37.37	-2.20	47.69	45.49	74.00	-28.51
	2320	PK	V	37.37	-1.90	46.00	44.1	74.00	-29.90
	11020	PK	V	35.73	22.72	24.25	46.97	74.00	-27.03
802.11ac (VHT40) Ch118	1341	PK	H	37.33	-7.63	48.41	40.78	74.00	-33.22
	1946	PK	H	37.37	-2.07	44.64	42.57	74.00	-31.43
	2463	PK	H	37.37	-2.11	44.83	42.72	74.00	-31.28
	11180	PK	H	35.74	22.81	25.23	48.03	74.00	-25.97
	1341	PK	V	37.33	-7.63	48.76	41.13	74.00	-32.87
	1946	PK	V	37.37	-2.07	43.25	41.18	74.00	-32.82
	2694	PK	V	37.4	-1.15	45.03	43.88	74.00	-30.12
	3365	PK	V	37.37	0.96	45.94	46.91	74.00	-27.09
	11180	PK	V	35.74	22.81	24.34	47.14	74.00	-26.86

**TEST REPORT**

**Chain0+1**

Mode	Frequency (MHz)	Spectrum Analyzer Detector	Ant. Pol. (H/V)	Preamp. Gain (dB)	Correction Factor (dB/m)	Reading (dBμV)	Corrected Reading (dBμV/m)	Limit @ 3 m (dBμV/m)	Margin (dB)
802.11ac (VHT40) Ch134	1341	PK	H	37.33	-7.63	48.06	40.43	74.00	-33.57
	1946	PK	H	37.37	-2.07	46.37	44.29	74.00	-29.71
	2386	PK	H	37.37	-2.00	44.14	42.14	74.00	-31.86
	3365	PK	H	37.37	0.96	44.51	45.47	74.00	-28.53
	11340	PK	H	35.75	22.89	24.45	47.34	74.00	-26.66
	1264	PK	V	37.31	-7.75	48.87	41.13	74.00	-32.87
	1726	PK	V	37.37	-4.69	46.71	42.02	74.00	-31.98
	2320	PK	V	37.37	-1.90	45.20	43.3	74.00	-30.70
	3442	PK	V	37.35	1.07	45.69	46.76	74.00	-27.24
	11340	PK	V	35.75	22.89	24.42	47.3	74.00	-26.70
802.11ac (VHT40) Ch151	1341	PK	H	37.33	-7.63	50.33	42.7	74.00	-31.30
	2309	PK	H	37.37	-1.89	46.96	45.07	74.00	-28.93
	3365	PK	H	37.37	0.96	42.80	43.77	74.00	-30.23
	11510	PK	H	35.76	22.96	23.75	46.71	74.00	-27.29
	1341	PK	V	37.33	-7.63	49.82	42.2	74.00	-31.80
	1869	PK	V	37.37	-2.99	46.23	43.24	74.00	-30.76
	2386	PK	V	37.37	-2.00	46.64	44.64	74.00	-29.36
	3365	PK	V	37.37	0.96	42.51	43.47	74.00	-30.53
	11510	PK	V	35.76	22.96	23.65	46.61	74.00	-27.39
802.11ac (VHT40) Ch159	1341	PK	H	37.33	-7.63	49.94	42.31	74.00	-31.69
	1935	PK	H	37.37	-2.20	50.17	47.97	74.00	-26.03
	2320	PK	H	37.37	-1.90	43.78	41.87	74.00	-32.13
	3585	PK	H	37.32	1.45	41.56	43.01	74.00	-30.99
	11590	PK	H	35.74	22.84	23.14	45.98	74.00	-28.02
	1341	PK	V	37.33	-7.63	50.57	42.94	74.00	-31.06
	2012	PK	V	37.37	-1.45	44.04	42.6	74.00	-31.40
	2386	PK	V	37.37	-2.00	50.53	48.53	74.00	-25.47
	11590	PK	V	35.74	22.84	25.40	48.25	74.00	-25.75

Remark: Correction Factor = Antenna Factor + Cable Loss + High Pass Filter Loss - Pre\_Amplifier Gain

**TEST REPORT**

**Chain0+1**

Mode	Frequency (MHz)	Spectrum Analyzer Detector	Ant. Pol. (H/V)	Preamp. Gain (dB)	Correction Factor (dB/m)	Reading (dBμV)	Corrected Reading (dBμV/m)	Limit @ 3 m (dBμV/m)	Margin (dB)
802.11ac (VHT80) Ch42	1187	PK	H	37.29	-7.87	49.36	41.49	74.00	-32.51
	1869	PK	H	37.37	-2.99	47.60	44.61	74.00	-29.39
	1946	PK	H	37.37	-2.07	48.84	46.76	74.00	-27.24
	2166	PK	H	37.37	-1.68	44.81	43.13	74.00	-30.87
	3365	PK	H	37.37	0.96	42.50	43.46	74.00	-30.54
	10420	PK	H	35.74	20.36	26.83	47.19	74.00	-26.81
	1341	PK	V	37.33	-7.63	47.96	40.33	74.00	-33.67
	1946	PK	V	37.37	-2.07	44.27	42.19	74.00	-31.81
	2353	PK	V	37.37	-1.95	44.40	42.45	74.00	-31.55
	2837	PK	V	37.42	-0.39	41.85	41.45	74.00	-32.55
	10420	PK	V	35.74	20.36	25.78	46.15	74.00	-27.85
802.11ac (VHT80) Ch58	1187	PK	H	37.29	-7.87	48.29	40.42	74.00	-33.58
	1869	PK	H	37.37	-2.99	46.56	43.58	74.00	-30.42
	2760	PK	H	37.41	-0.80	45.32	44.52	74.00	-29.48
	3442	PK	H	37.35	1.07	42.80	43.87	74.00	-30.13
	10580	PK	H	35.7	21.17	25.29	46.45	74.00	-27.55
	1341	PK	V	37.33	-7.63	47.56	39.93	74.00	-34.07
	2012	PK	V	37.37	-1.45	42.77	41.33	74.00	-32.67
	3365	PK	V	37.37	0.96	42.92	43.88	74.00	-30.12
	10580	PK	V	35.7	21.17	24.19	45.35	74.00	-28.65
802.11ac (VHT80) Ch106	1341	PK	H	37.33	-7.63	48.40	40.77	74.00	-33.23
	1935	PK	H	37.37	-2.20	47.66	45.45	74.00	-28.55
	2386	PK	H	37.37	-2.00	45.10	43.1	74.00	-30.90
	3585	PK	H	37.32	1.45	43.27	44.72	74.00	-29.28
	11060	PK	H	35.73	22.74	24.28	47.03	74.00	-26.97
	1341	PK	V	37.33	-7.63	49.82	42.19	74.00	-31.81
	1726	PK	V	37.37	-4.69	45.73	41.04	74.00	-32.96
	2166	PK	V	37.37	-1.68	43.34	41.66	74.00	-32.34
	4036	PK	V	37.25	3.00	43.73	46.73	74.00	-27.27
	11060	PK	V	35.73	22.74	24.96	47.7	74.00	-26.30

Remark: Correction Factor = Antenna Factor + Cable Loss + High Pass Filter Loss - Pre\_Amplifier Gain

**TEST REPORT**

**Chain0+1**

Mode	Frequency (MHz)	Spectrum Analyzer Detector	Ant. Pol. (H/V)	Preamp. Gain (dB)	Correction Factor (dB/m)	Reading (dBμV)	Corrected Reading (dBμV/m)	Limit @ 3 m (dBμV/m)	Margin (dB)
802.11ac (VHT80) Ch122	1341	PK	H	37.33	-7.63	47.49	39.86	74.00	-34.14
	1946	PK	H	37.37	-2.07	47.64	45.57	74.00	-28.43
	2463	PK	H	37.37	-2.11	45.28	43.17	74.00	-30.83
	3288	PK	H	37.39	0.86	44.15	45.01	74.00	-28.99
	11220	PK	H	35.74	22.83	24.53	47.36	74.00	-26.64
	1341	PK	V	37.33	-7.63	48.55	40.92	74.00	-33.08
	2012	PK	V	37.37	-1.45	44.31	42.86	74.00	-31.14
	2364	PK	V	37.37	-1.97	43.72	41.76	74.00	-32.24
	3365	PK	V	37.37	0.96	42.34	43.3	74.00	-30.70
	11220	PK	V	35.74	22.83	24.66	47.49	74.00	-26.51
802.11ac (VHT80) Ch155	1341	PK	H	37.33	-7.63	49.96	42.33	74.00	-31.67
	1946	PK	H	37.37	-2.07	45.51	43.43	74.00	-30.57
	3585	PK	H	37.32	1.45	40.84	42.29	74.00	-31.71
	11550	PK	H	35.75	22.90	23.75	46.65	74.00	-27.35
	1341	PK	V	37.33	-7.63	49.69	42.06	74.00	-31.94
	1495	PK	V	37.37	-7.39	51.10	43.71	74.00	-30.29
	2342	PK	V	37.37	-1.94	45.93	43.99	74.00	-30.01
	11550	PK	V	35.75	22.90	24.43	47.33	74.00	-26.67



## 6. Emission on The Band Edge

### 6.1 Operating environment

Temperature:	25	°C
Relative Humidity:	50	%
Atmospheric Pressure	1008	hPa
Requirement	15.407(b), 15.209	
Channel	36, 38, 42, 46, 48 149, 157, 165, 151, 159, 155	

### 6.2 Measuring instrument setting

Spectrum analyzer settings	
Spectrum Analyzer function	Setting
Detector	Peak
RBW	1MHz
VBW	3MHz for Peak; 10Hz for Average
Sweep	Auto couple
Restrict bands	4500~5150MHz
	5350 ~5460MHz
Attenuation	Auto

Applicable to	Limit	
	EIRP Limit (dBm)	Equivalent Field Strength at 3m (dBμV/m)
5715-5725MHz	PK	PK
5850-5860MHz	-17	78.2

### 6.3 Test procedure

The test procedure is the same as clause 5.4

6.4 Test Result

Mode	Frequency (MHz)	Spectrum Analyzer Detector	Ant. Pol. (H/V)	Preamp. Gain (dB)	Correction Factor (dB/m)	Reading (dBμV)	Corrected Reading (dBμV/m)	Limit @ 3 m (dBμV/m)	Margin (dB)	Restricted band (MHz)
802.11a Chain0	5150.00	PK	V	37.05	5.67	46.71	52.38	74	-21.62	4500~5150
	5150.00	AV	V	37.05	5.67	35.78	41.45	54	-12.55	
	5350.00	PK	V	37.01	5.79	38.94	44.73	74	-29.27	5350~5460
	5388.80	AV	V	37.00	5.82	28.51	34.33	54	-19.67	
802.11a Chain1	5130.80	PK	V	37.05	5.65	43.64	49.29	74	-24.71	4500~5150
	5150.00	AV	V	37.05	5.67	31.33	37.00	54	-17.00	
	5391.68	PK	V	37.00	5.82	36.62	42.44	74	-31.56	5350~5460
	5390.96	AV	V	37.00	5.82	26.06	31.88	54	-22.12	
802.11ac (VHT20) Chain0+1	5150.00	PK	V	37.05	5.67	51.83	57.50	74	-16.50	4500~5150
	5150.00	AV	V	37.05	5.67	34.39	40.06	54	-13.94	
	5385.93	PK	V	37.00	5.82	40.96	46.78	74	-27.22	5350~5460
	5350.00	AV	V	37.01	5.79	28.25	34.04	54	-19.96	
802.11ac (VHT40) Chain0+1	5150.00	PK	V	37.05	5.67	63.17	68.84	74	-5.16	4500~5150
	5150.00	AV	V	37.05	5.67	43.44	49.11	54	-4.89	
	5363.65	PK	V	37.01	5.80	43.23	49.03	74	-24.97	5350~5460
	5350.00	AV	V	37.01	5.79	28.56	34.35	54	-19.65	
802.11ac (VHT80) Chain0+1	5147.50	PK	V	37.05	5.66	61.99	67.65	74	-6.35	4500~5150
	5147.50	AV	V	37.05	5.66	39.05	44.71	54	-9.29	
	5361.64	PK	V	37.01	5.80	46.12	51.92	74	-22.08	5350~5460
	5350.00	AV	V	37.01	5.79	29.21	35.00	54	-19.00	

Remark: Correction Factor = Antenna Factor + Cable Loss

Chain0 : Restricted Band Bandedge @ 802.11a Mode Ch36 PK

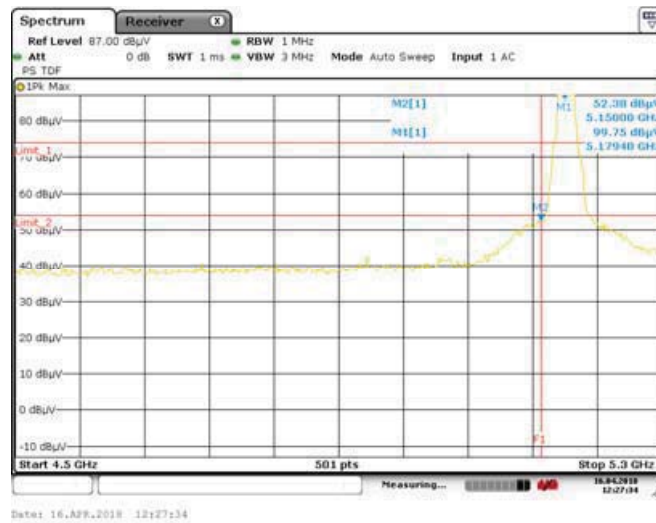

Chain0 : Restricted Band Bandedge @ 802.11a Mode Ch36 AV

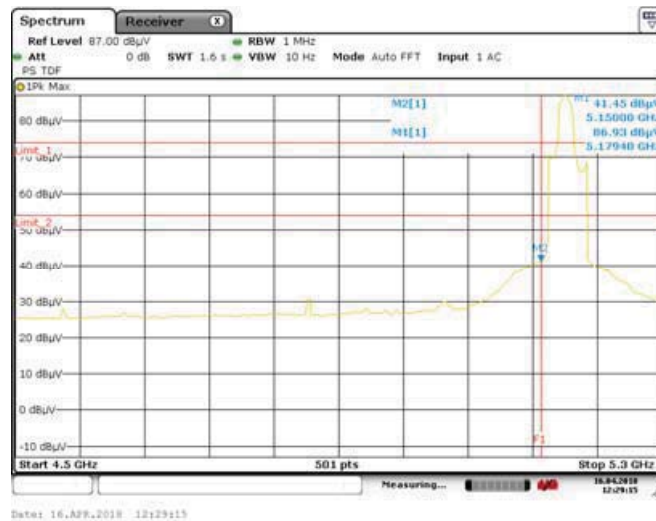

Chain0 : Restricted Band Bandedge @ 802.11a Mode Ch48 PK

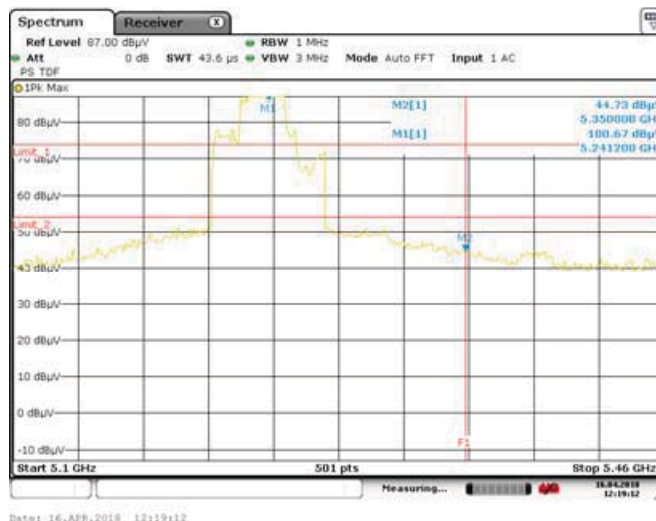

### Chain0 : Restricted Band Bandedge @ 802.11a Mode Ch48 AV

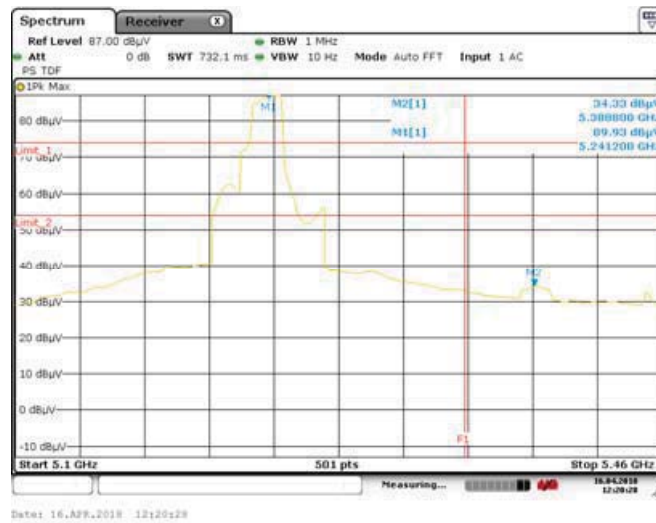

### Chain1 : Restricted Band Bandedge @ 802.11a Mode Ch36 PK

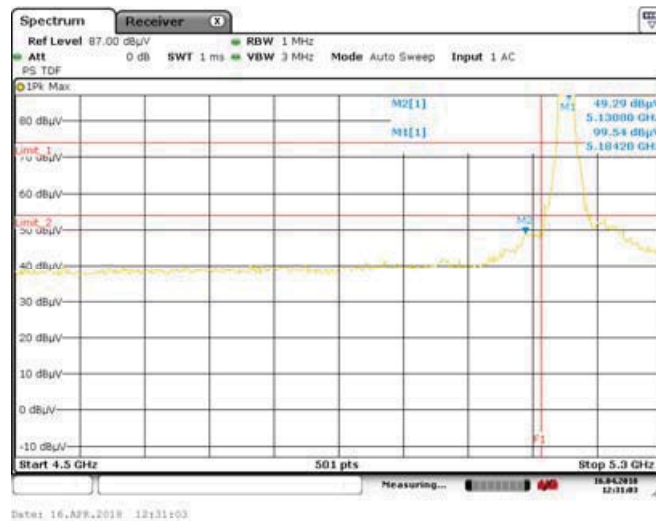

### Chain1 : Restricted Band Bandedge @ 802.11a Mode Ch36 AV

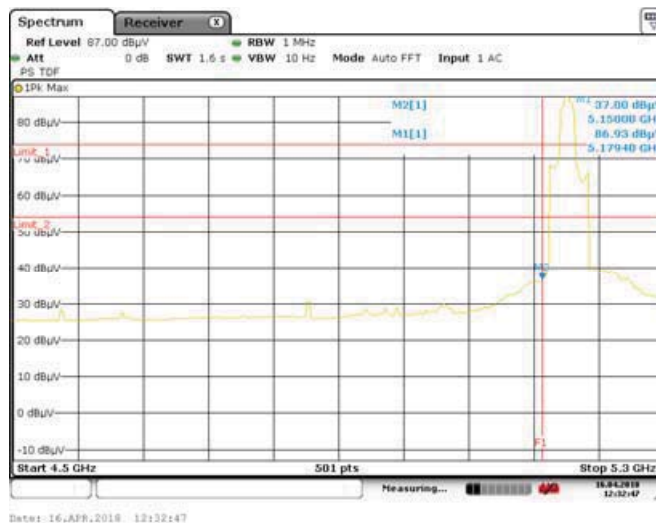

Chain1 : Restricted Band Bandedge @ 802.11a Mode Ch48 PK

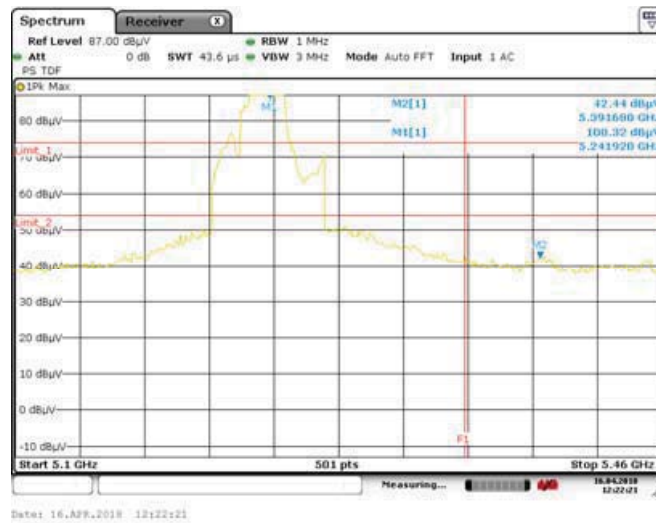

Chain1 : Restricted Band Bandedge @ 802.11a Mode Ch48 AV

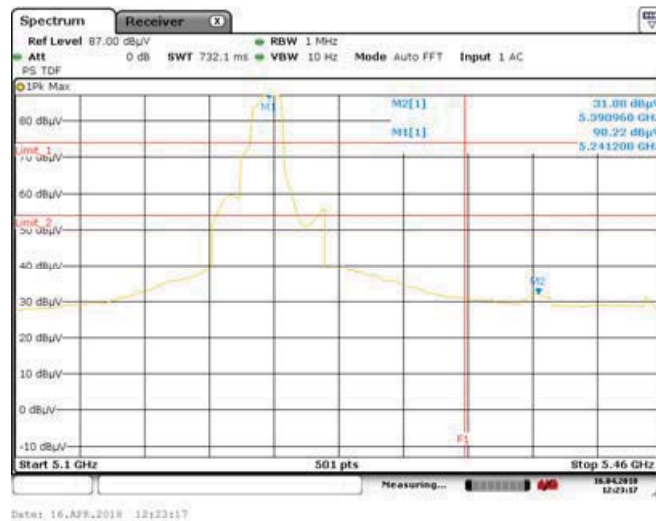

Chain0+1 : Restricted Band Bandedge @ 802.11ac(VHT20) Mode Ch36 PK

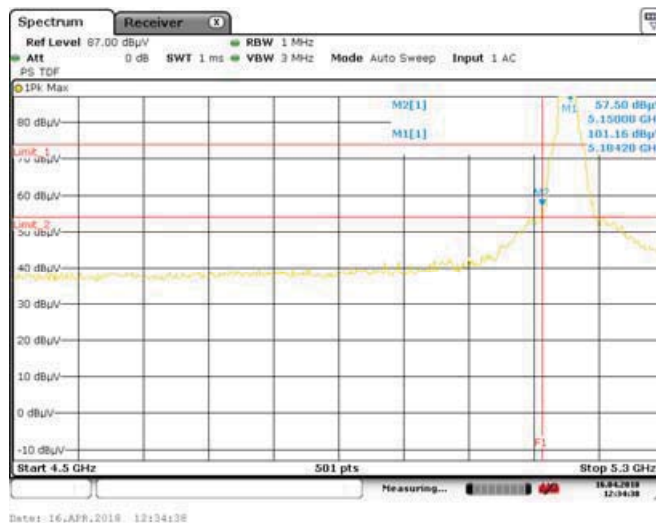

### Chain0+1 : Restricted Band Bandedge @ 802.11ac(VHT20) Mode Ch36 AV

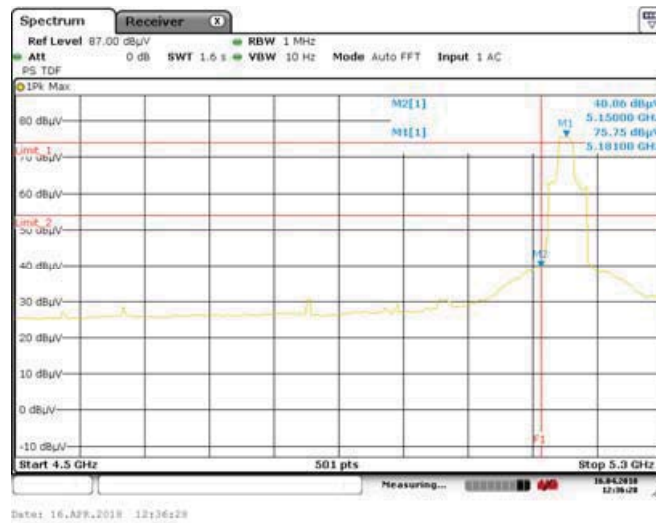

### Chain0+1 : Restricted Band Bandedge @ 802.11ac(VHT20) Mode Ch48 PK

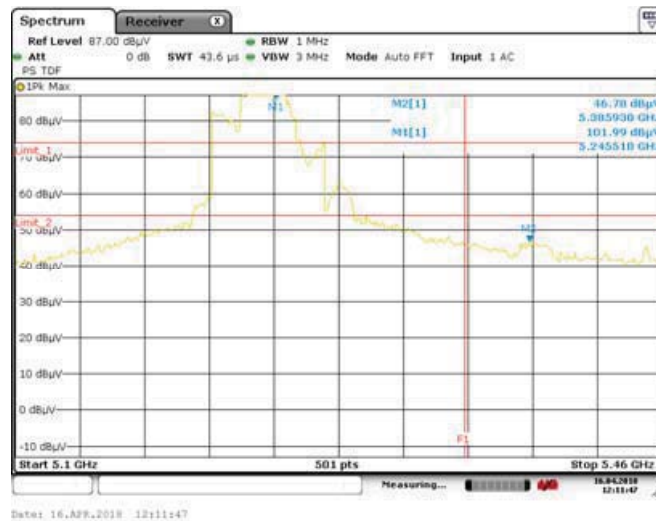

### Chain0+1 : Restricted Band Bandedge @ 802.11ac(VHT20) Mode Ch48 AV

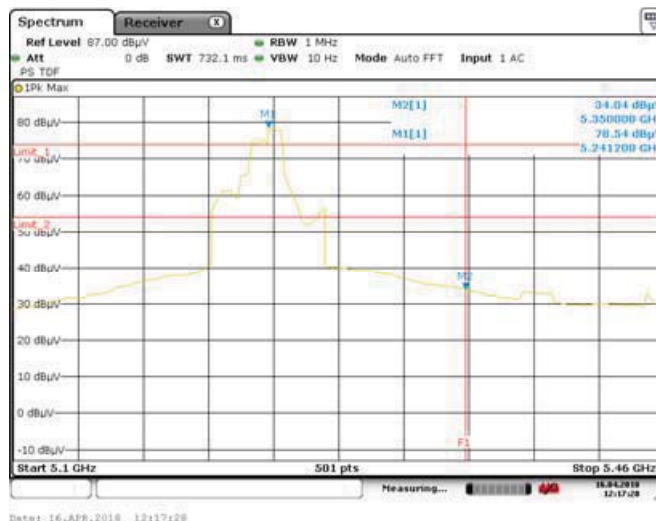

### Chain0+1 : Restricted Band Bandedge @ 802.11ac(VHT40) Mode Ch38 PK

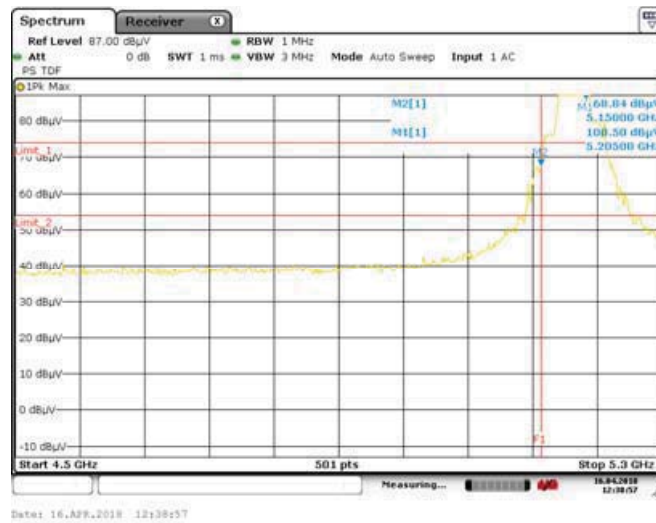

### Chain0+1 : Restricted Band Bandedge @ 802.11ac(VHT40) Mode Ch38 AV

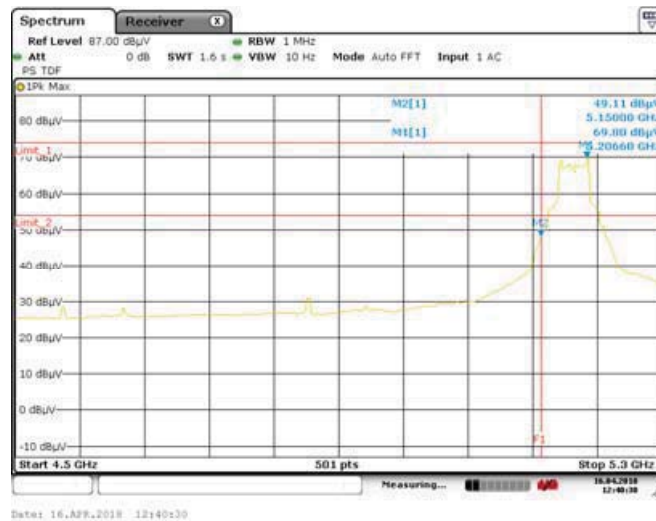

### Chain0+1 : Restricted Band Bandedge @ 802.11ac(VHT40) Mode Ch46 PK

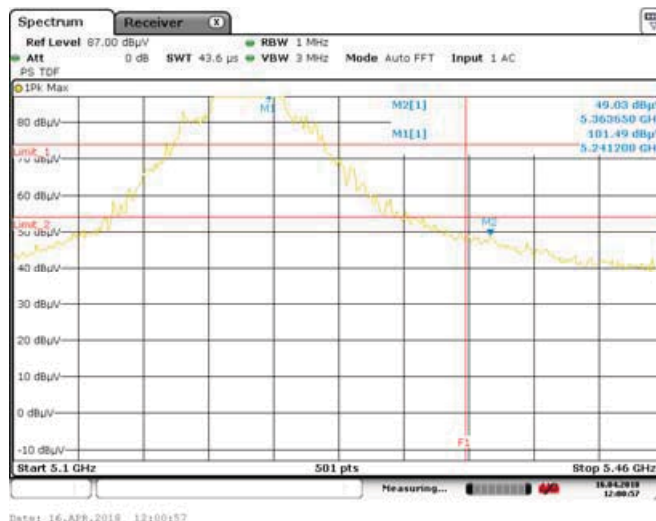

### Chain0+1 : Restricted Band Bandedge @ 802.11ac(VHT40) Mode Ch46 AV

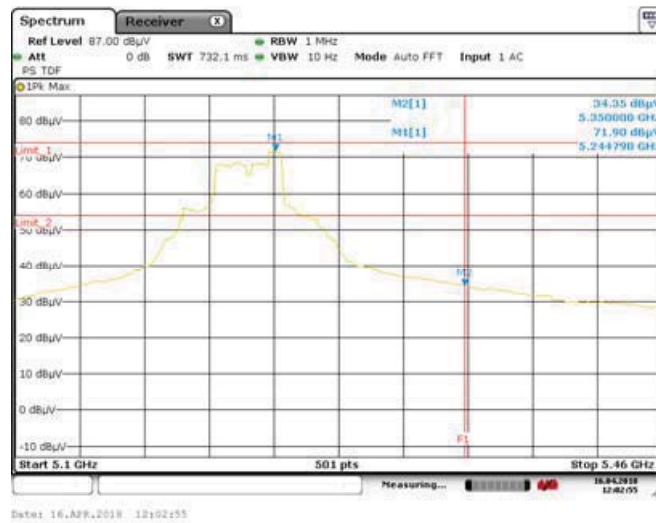

### Chain0+1 : Restricted Band Bandedge @ 802.11ac(VHT80) Mode Ch42 Lower PK

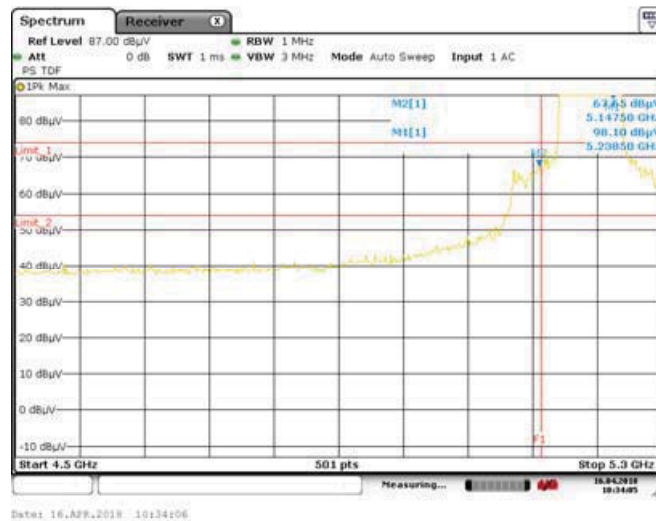

### Chain0+1 : Restricted Band Bandedge @ 802.11ac(VHT80) Mode Ch42 Lower AV

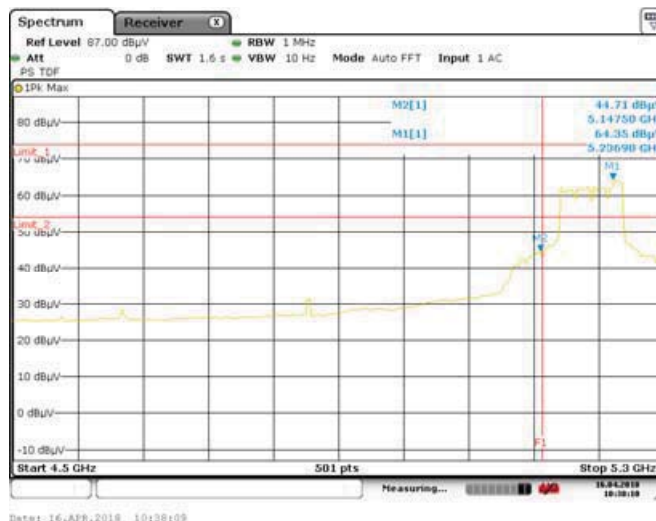



### Chain0+1 : Restricted Band Bandedge @ 802.11ac(VHT80) Mode Ch42 Upper PK

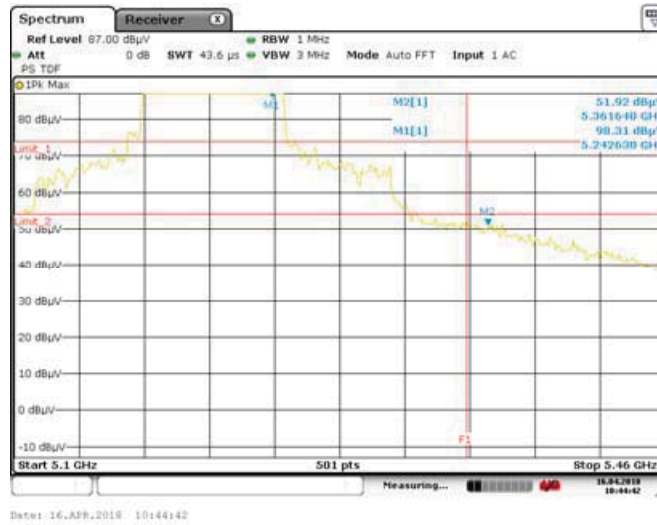

### Chain0+1 : Restricted Band Bandedge @ 802.11ac(VHT80) Mode Ch42 Upper AV

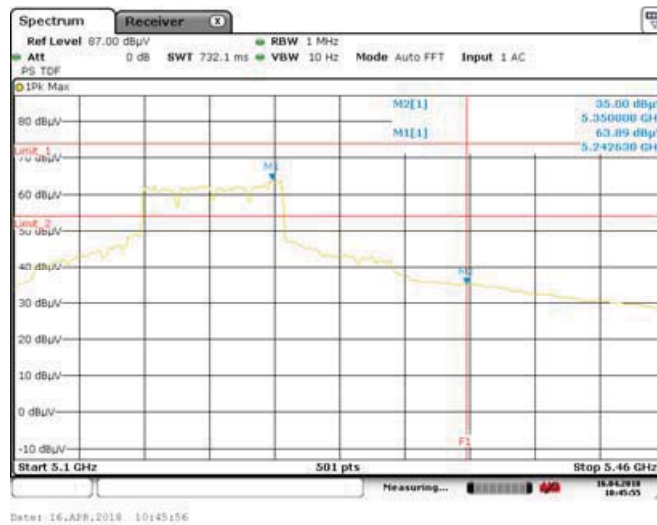

### Chain0 : Out-of-band emission limits for U-NII-3 @ mode 802.11a Ch149

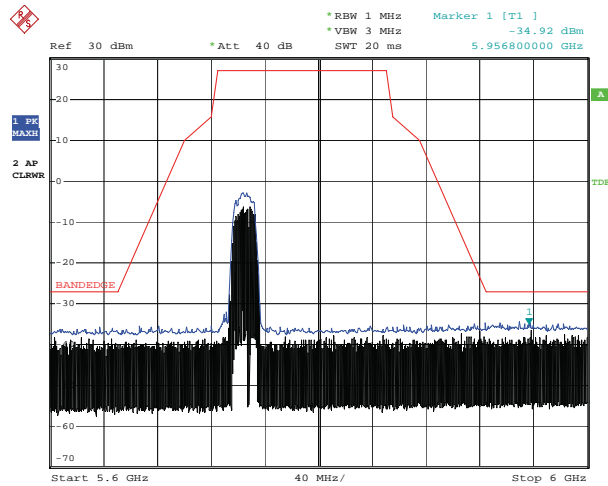

Date: 16.APR.2018 17:41:20

### Chain0 : Out-of-band emission limits for U-NII-3 @ mode 802.11a Ch157

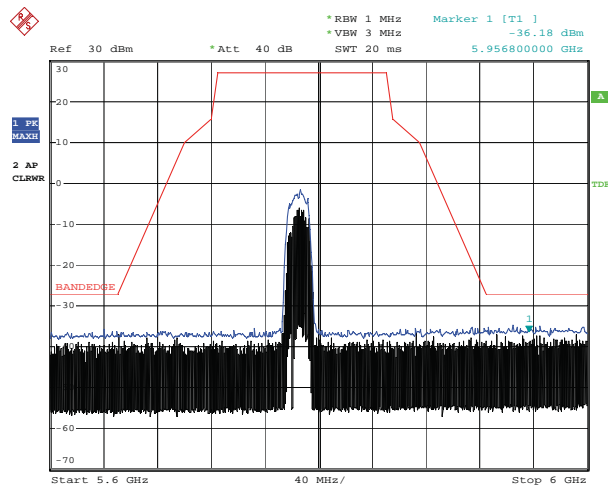

Date: 16.APR.2018 17:43:14

### Chain0 : Out-of-band emission limits for U-NII-3 @ mode 802.11a Ch165

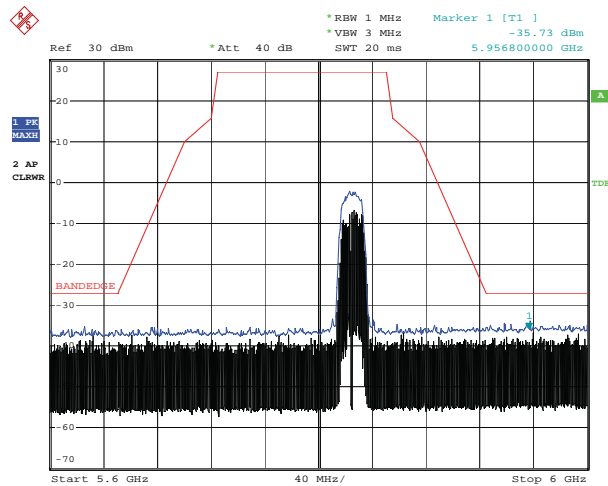

Date: 16.APR.2018 17:55:25

### Chain1 : Out-of-band emission limits for U-NII-3 @ mode 802.11a Ch149

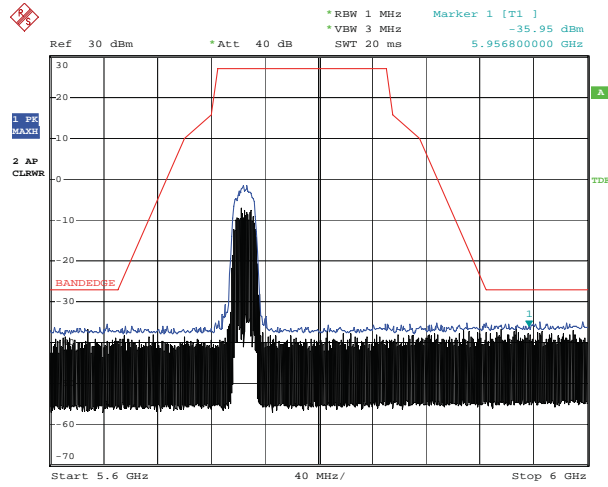

Date: 16.APR.2018 18:00:42

### Chain1 : Out-of-band emission limits for U-NII-3 @ mode 802.11a Ch157

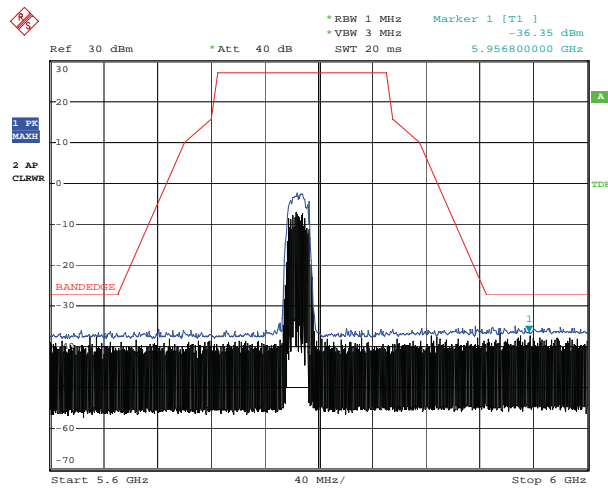

Date: 16.APR.2018 17:59:06

### Chain1 : Out-of-band emission limits for U-NII-3 @ mode 802.11a Ch165

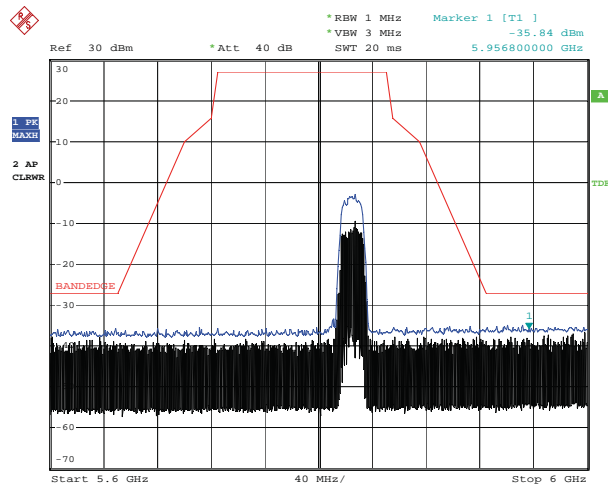

Date: 16.APR.2018 17:57:38

### Chain0+1 : Out-of-band emission limits for U-NII-3 @ mode 802.11ac(VHT20) Ch149

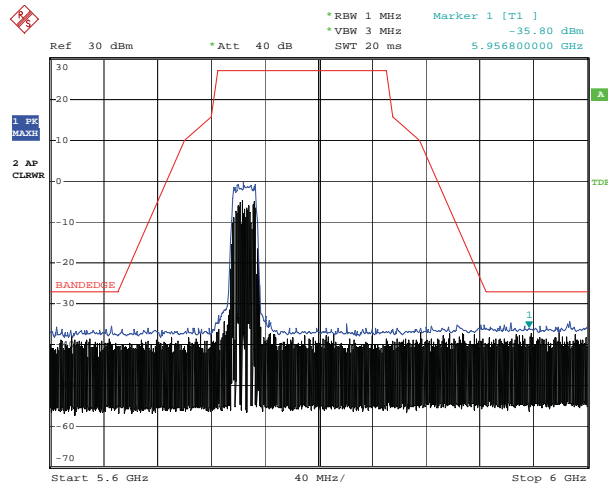

Date: 16.APR.2018 17:29:04

### Chain0+1 : Out-of-band emission limits for U-NII-3 @ mode 802.11ac(VHT20) Ch157

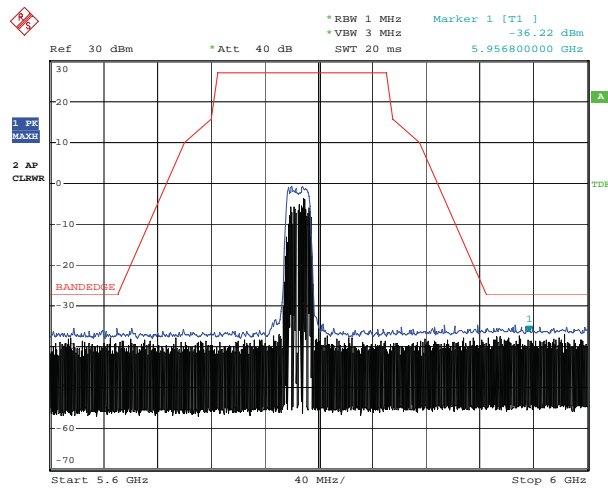

Date: 16.APR.2018 17:31:11

### Chain0+1 : Out-of-band emission limits for U-NII-3 @ mode 802.11ac(VHT20) Ch165

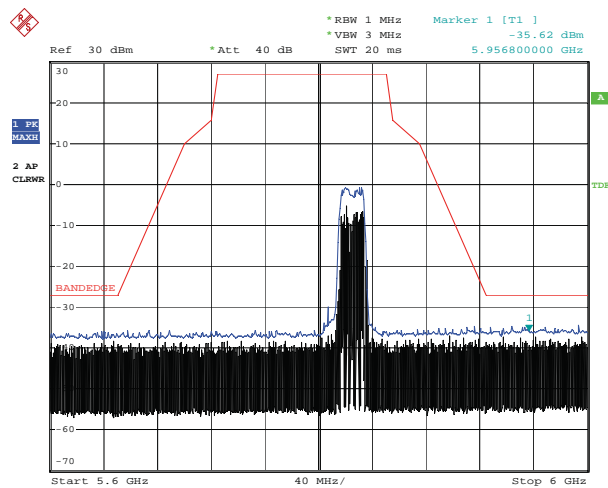

Date: 16.APR.2018 17:33:32

### Chain0+1 : Out-of-band emission limits for U-NII-3 @ mode 802.11ac(VHT40) Ch151

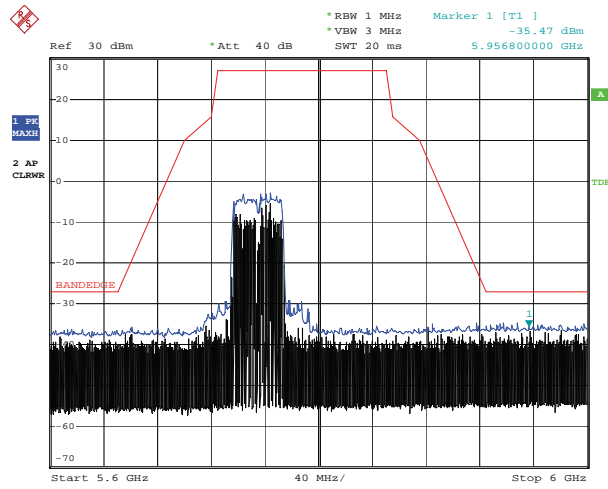

Date: 16.APR.2018 17:24:46

### Chain0+1 : Out-of-band emission limits for U-NII-3 @ mode 802.11ac(VHT40) Ch159

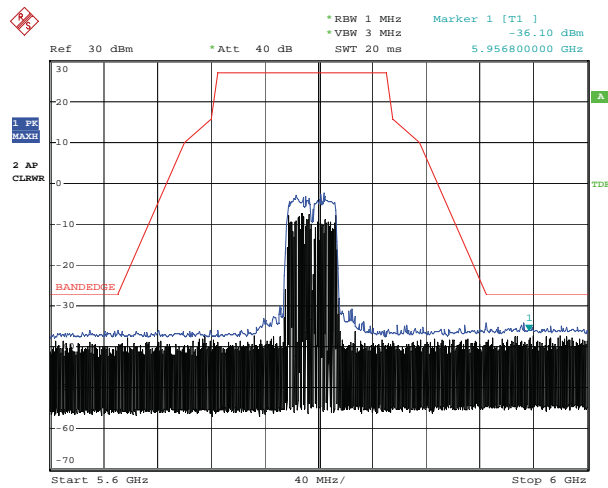

Date: 16.APR.2018 17:27:04

### Chain0+1 : Out-of-band emission limits for U-NII-3 @ mode 802.11ac(VHT80) Ch155

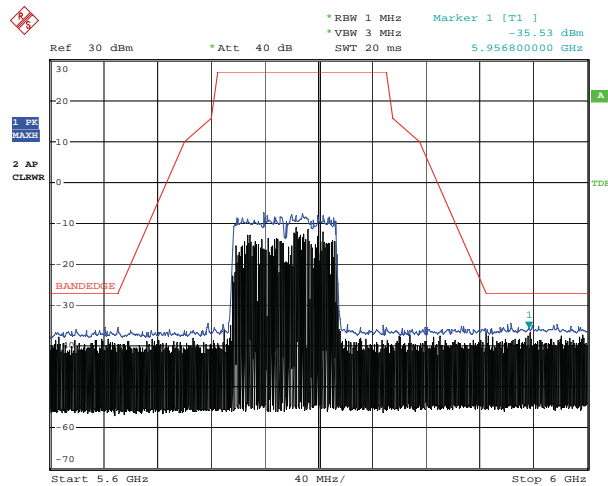

Date: 16.APR.2018 17:20:43

## 7. Dynamic Frequency Selection (DFS) test

### 7.1 Operating environment

Temperature:	25	°C
Relative Humidity:	50	%
Atmospheric Pressure:	1008	hPa

### 7.2 UNII Device Description

1. The UAP-AC-M operates in the following UNII bands:

- a. 5250-5350 MHz
- b. 5470-5725 MHz

2. Operating mode:

The EUT was defined as the client without radar detection function.

Associating peripheral:

The device was set up to associate with the master device (UAP-AC-M).

3. The maximum EIRP of this device is 11.39 dBm from UNII band. This device doesn't exceed 27dBm EIRP, so no transmit power control is implemented.

4. Below are the available 50 ohm antenna assemblies and their corresponding gains. 0dBi gain was used to set the -63dBm threshold level (-62dBm+1dB) during calibration of the conducted test setup.

5. Information regarding the parameters of the detected Radar Waveforms is not available to the end user.

### 7.2.1 Operating mode

Performance was measured at an active frequency of 5260 and 5500MHz, and the radar signal was centered at 5260 and 5500 MHz.

One laptop PC is connected to the AP via a wire Ethernet connection. A separate laptop PC is used as a host computer for the Station. The AP and the Station transmit output levels are set to normal operating condition.

System architectures were used under IP based mode.

### 7.3 Test Protocol and Requirements

For a Master Device, the DFS conformance requirements will be verified utilizing one short pulse radar type. Additionally, the Channel Move Time and Channel Closing Transmission Time requirements will be verified utilizing the long pulse radar type. The statistical performance check will be verified utilizing all radar type.

For a Client Device without DFS, the channel move time and channel closing transmission time requirements will be verified with one short pulse radar type.

For testing a Client Device with In-Service Monitoring, two configurations must be tested.

The Client Device detects the radar waveform:

The channel move time and channel closing transmission time requirements will be verified utilizing short pulse radar type and the long pulse radar type. The statistical performance check will be verified utilizing all radar types.

The Master Device detects the radar waveform:

The channel move time and channel closing transmission time requirements will be verified utilizing short pulse radar type.

A UNII network will employ a DFS function to:

- detect signals from radar systems and to avoid co-channel operation with these systems
- provide on aggregate a Uniform Spreading of the Operating Channels across the entire band. This applies to the 5250-5350 MHz and/ or 5470-5725 MHz bands.

Within the context of the operation of the DFS function, a UNII device will operate in either Master Mode or Client Mode. UNII devices operating in Client Mode can only operate in a network controlled by a UNII device operating in Master Mode.

The tables as below summarize the information contained.

**Applicability of DFS Requirements Prior to Use of a Channel**

Requirement	Operational Mode		
	Master	Client Without Radar Detection	Client With Radar Detection
Non-Occupancy Period	Yes	Not required	Yes
DFS Detection Threshold	Yes	Not required	Yes
Channel Availability Check Time	Yes	Not required	Not required
Uniform Spreading	Yes	Not required	Not required
UNII Detection Bandwidth	Yes	Not required	Yes

**Applicability of DFS requirements during normal operation**

Requirement	Operational Mode		
	Master	Client Without Radar Detection	Client With Radar Detection
DFS Detection Threshold	Yes	Not required	Yes
Channel Closing Transmission Time	Yes	Yes	Yes
Channel Move Time	Yes	Yes	Yes
UNII Detection Bandwidth	Yes	Not required	Yes



### 7.4 DFS Detection Thresholds and Limitations of each Parameter

Maximum Transmit Power	Value (See Notes 1 and 2)
$\geq$ 200 mW	-64 dBm
$\leq$ 200 mW	-62 dBm
<p>Note 1: This is the level at the input of the receiver assuming a 0 dBi receive antenna.</p> <p>Note 2: Throughout these test procedures an additional 1 dB has been added to the amplitude of the test transmission waveforms to account for variations in measurement equipment. This will ensure that the test signal is at or above the detection threshold level to trigger a DFS response.</p>	

Parameter	Value
Non-occupancy Period	Minimum 30 minutes
Channel Availability Check Time	60 seconds
Channel Move Time	10 seconds (See Note 1)
Channel Closing Transmission Time	200 milliseconds + an aggregate of 60 milliseconds over remaining 10 second period (See Note 1 and 2)
UNII Detection Bandwidth	Minimum 80% of the UNII 99% transmission power bandwidth. (See Note 3)
<p>Note 1: The instant that the Channel Move Time and the Channel Closing Transmission Time begins is as follows:</p> <ul style="list-style-type: none"> <li>• For the Short Pulse Radar Test Signals this instant is the end of the Burst.</li> <li>• For the Frequency Hopping radar Test Signal, this instant is the end of the last radar Burst generated.</li> <li>• For the Long Pulse Radar Test Signal this instant is the end of the 12 second period defining the Radar Waveform.</li> </ul> <p>Note 2: The Channel Closing Transmission Time is comprised of 200 milliseconds starting at the beginning of the Channel Move Time plus any additional intermittent control signals required to facilitate a Channel move (an aggregate of 60 milliseconds) during the remainder of the 10 second period. The aggregate duration of control signals will not count quiet periods in between transmissions.</p> <p>Note 3: During the U-NII Detection Bandwidth detection test, radar type 1 is used and for each frequency step the minimum percentage of detection is 90 percent. Measurements are performed with no data traffic.</p>	

**TEST REPORT**

**7.5 Radar Test Waveforms**

This section provides the parameters for required test waveforms, minimum percentage of successful detections, and the minimum number of trials that must be used for determining DFS conformance. Step intervals of 0.1 microsecond for Pulse Width, 1 microsecond for PRI, 1 MHz for chirp width and 1 for the number of pulses will be utilized for the random determination of specific test waveforms.

**Short Pulse Radar Test Waveforms**

Radar Type	Pulse Width (µsec)	PRI (µsec)	Number of Pulses	Minimum Percentage of Successful Detection	Minimum Number of Trials
1	1	1428	18	60%	30
2	1-5	150-230	23-29	60%	30
3	6-10	200-500	16-18	60%	30
4	11-20	200-500	12-16	60%	30
Aggregate (Radar Types 1-4)				80%	120

A minimum of 30 unique waveforms are required for each of the Short Pulse Radar Type 2 through 4. For Short Pulse Radar Type 1, the same waveform is used a minimum of 30 times. If more than 30 waveforms are used for Short Pulse Radar Type 2 through 4, then each additional waveform must also be unique and not repeated from the previous waveforms.

The aggregate is the average of the percentage of successful detections of Short Pulse Radar Type 1-4.

**Long Pulse Radar Test Waveforms**

Radar Type	Pulse Width (µsec)	Chirp Width (MHz)	PRI (µsec)	Number of Pulses per Burst	Number of Bursts	Minimum Percentage of Successful Detection	Minimum Number of Trials
5	50-100	5-20	1000-2000	1-3	8-20	80%	30

The parameters for this waveform are randomly chosen. Thirty unique waveforms are required for the Long Pulse radar test signal. If more than 30 waveforms are used for the Long Pulse radar test signal, then each additional waveform must also be unique and not repeated from the previous waveforms.

Each waveform is defined as follows:

- 1) The transmission period for the Long Pulse Radar test signal is 12 seconds.
- 2) There are a total of 8 to 20 Bursts in the 12 second period, with the number of Bursts being randomly chosen. This number is Burst\_Count.
- 3) Each Burst consists of 1 to 3 pulses, with the number of pulses being randomly chosen. Each Burst within the 12 second sequence may have a different number of pulses.
- 4) The pulse width is between 50 and 100 microseconds, with the pulse width being randomly chosen. Each pulse within a Burst will have the same pulse width. Pulses in different Bursts may have different pulse widths.
- 5) Each pulse has a linear FM chirp between 5 and 20 MHz, with the chirp width being randomly chosen. Each pulse within a Burst will have the same chirp width. Pulses in different Bursts may have different chirp widths. The chirp is centered on the pulse. For example, with a radar frequency of 5300 MHz and a 20 MHz chirped signal, the chirp starts at 5290 MHz and ends at 5310 MHz.
- 6) If more than one pulse is present in a Burst, the time between the pulses will be between 1000 and 2000 microseconds, with the time being randomly chosen. If three pulses are present in a Burst, the time between the first and second pulses is chosen independently of the time between the second and third pulses.
- 7) The 12 second transmission period is divided into even intervals. The number of intervals is equal to Burst\_Count. Each interval is of length  $(12,000,000 / \text{Burst\_Count})$  microseconds. Each interval contains one Burst. The start time for the Burst, relative to the beginning of the interval, is between 1 and  $[(12,000,000 / \text{Burst\_Count}) - (\text{Total Burst Length}) + (\text{One Random PRI Interval})]$  microseconds, with the start time being randomly chosen. The step interval for the start time is 1 microsecond. The start time for each Burst is chosen independently.

A representative example of a Long Pulse radar test waveform:

- 1) The total test signal length is 12 seconds.
- 2) 8 Bursts are randomly generated for the Burst\_Count.
- 3) Burst 1 has 2 randomly generated pulses.
- 4) The pulse width (for both pulses) is randomly selected to be 75 microseconds.

## TEST REPORT

- 5) The PRI is randomly selected to be at 1213 microseconds.
- 6) Bursts 2 through 8 are generated using steps 3 – 5.
- 7) Each Burst is contained in even intervals of 1,500,000 microseconds. The starting location for Pulse 1, Burst 1 is randomly generated (1 to 1,500,000 minus the total Burst 1 length + 1 random PRI interval) at the 325,001 microsecond step. Bursts 2 through 8 randomly fall in successive 1,500,000 microsecond intervals (i.e. Burst 2 falls in the 1,500,001 – 3,000,000 microsecond range).

*Graphical Representation of a Long Pulse radar Test Waveform*

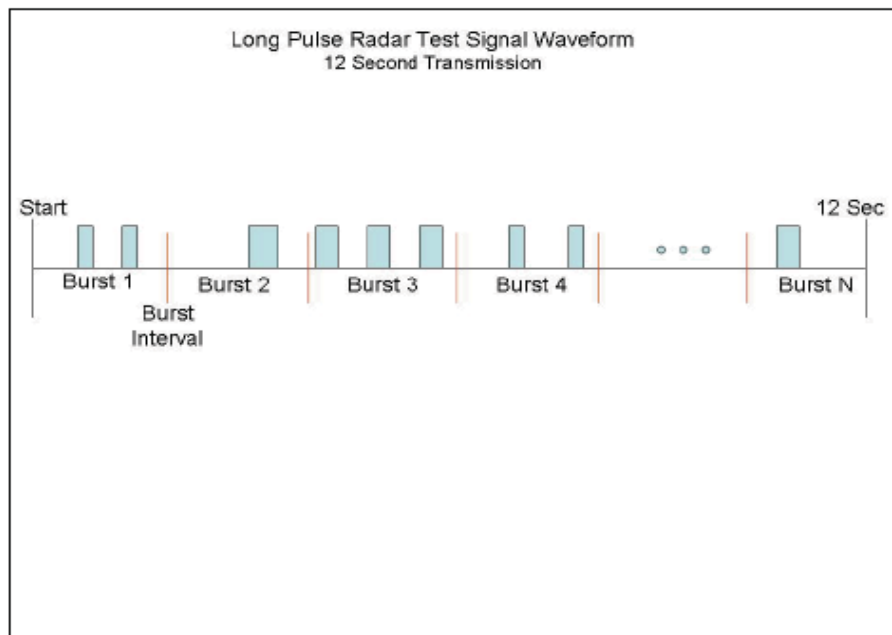

### Frequency Hopping Radar Test Waveforms

Radar Type	Pulse Width (μsec)	PRI (μsec)	Pulses per Hop	Hopping Rate (kHz)	Hopping Sequence Length (msec)	Minimum Percentage of Successful Detection	Minimum Number of Trials
6	1	333	9	0.333	300	70%	30

For the Frequency Hopping Radar Type, the same *Burst* parameters are used for each waveform.

The hopping sequence is different for each waveform and a 100-length segment is selected from the hopping sequence defined by the following algorithm:

The first frequency in a hopping sequence is selected randomly from the group of 475 integer frequencies from 5250 – 5724 MHz. Next, the frequency that was just chosen is removed from the group and a frequency is randomly selected from the remaining 474 frequencies in the group. This process continues until all 475 frequencies are chosen for the set. For selection of a random frequency, the frequencies remaining within the group are always treated as equally likely.

**7.6 Radar Waveform Calibration**

The following equipment setup was used to calibrate the conducted radar waveform. A spectrum analyzer is used to establish the test signal level for each radar type. During this process, there were no transmissions by either Master or Client device. The spectrum analyzer was switched to the zero span (time domain) mode at the frequency of the radar waveform generator. The peak detection was utilized. The spectrum analyzer RBW and VBW were set to at least 3MHz.

The signal generator amplitude and/ or step attenuators were set so that the power level measured at the spectrum analyzer was equal to the DFS detection threshold that is required for the tests.

The signal generator amplitude was set so that the power level measured at the spectrum analyzer was –61 dBm.

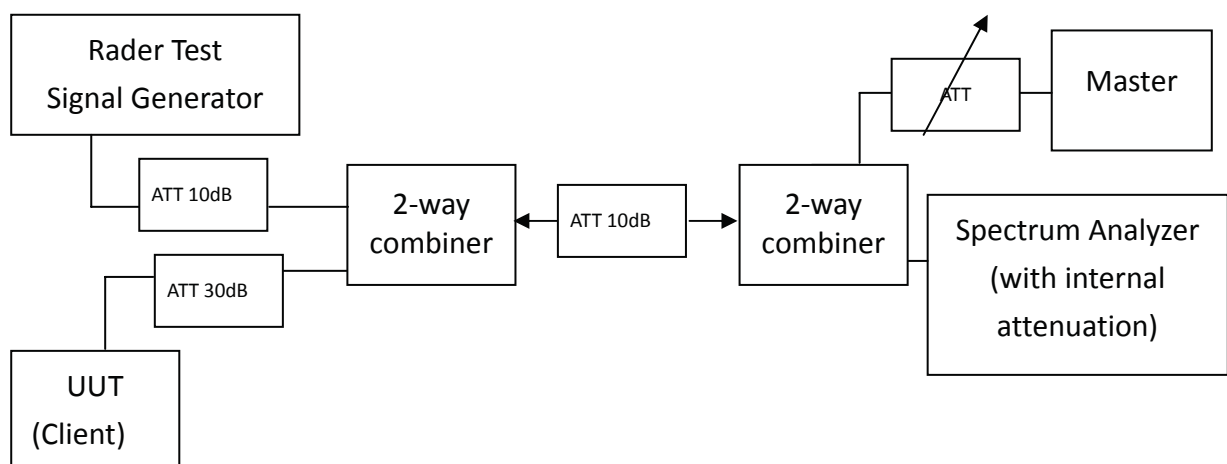

## 7.6.1 Radar Waveform Calibration Plots

Type Radar Signal @ 802.11a mode at 5260 MHz

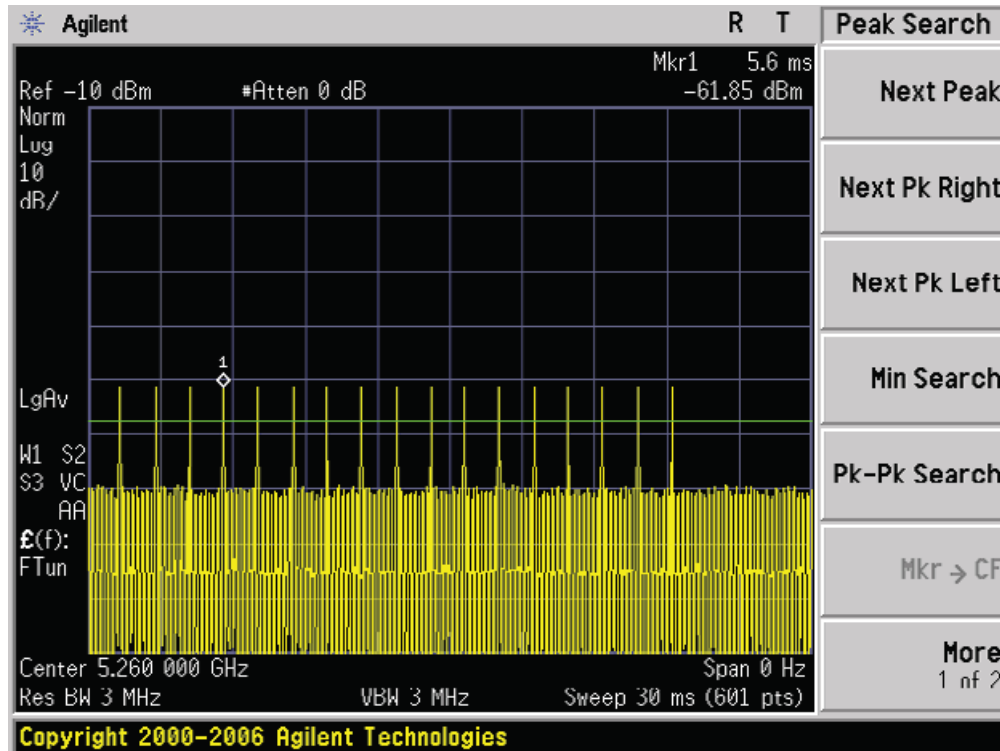

Type Radar Signal @ 802.11a mode at 5500 MHz

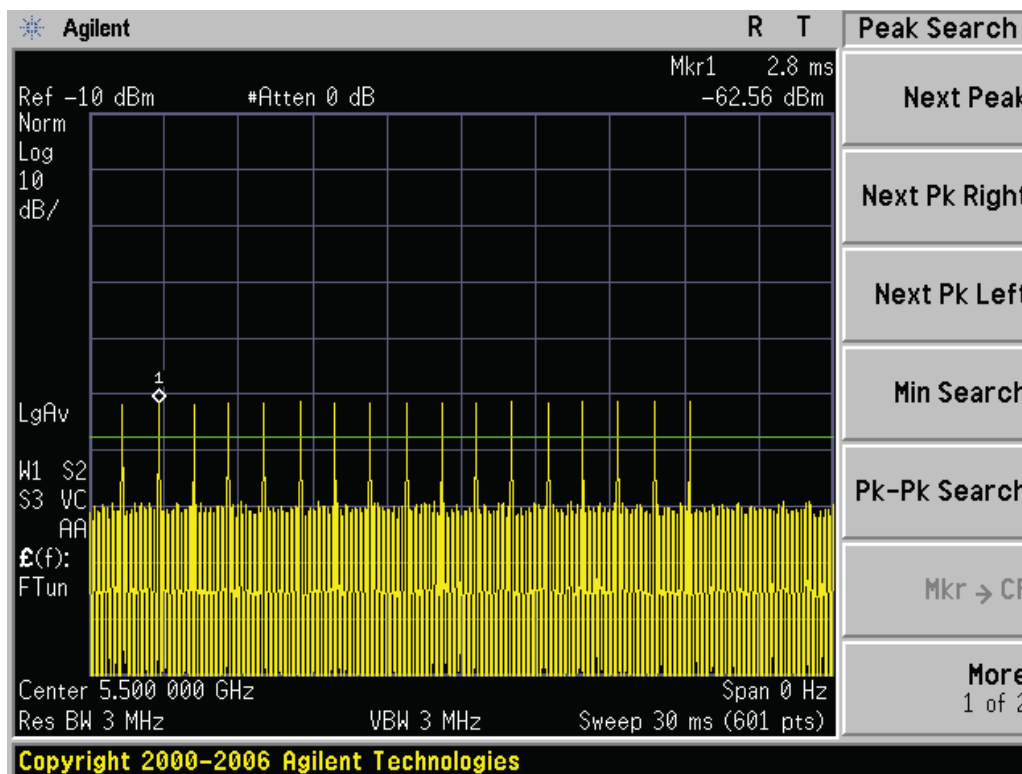

## 7.7 Test instruments and setup

### 7.7.1 Deviation about the radar waveform

No deviation.

### 7.7.2 Test setup

Setup for Client with injection at the Master (Client Mode without DFS detection)

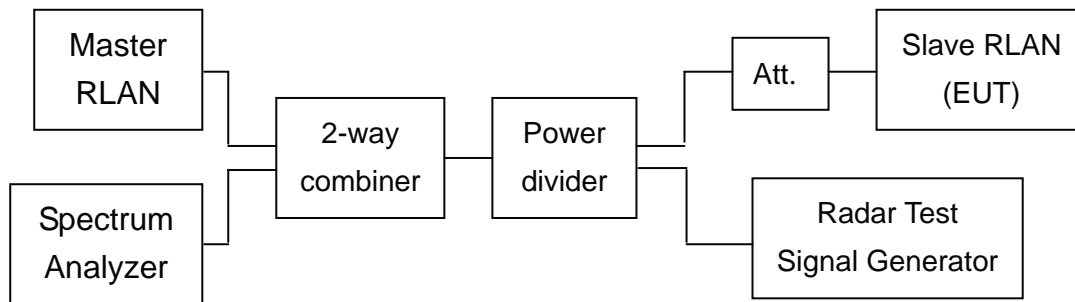

## 7.8 DFS test results

### 7.8.1 Test summary

This EUT was defined as the Client without DFS detection.

Clause	Parameter	Required	Result
15.407	DFS Detection Threshold	Not Required	N/A
15.407	Channel Availability Check Time	Not Required	N/A
15.407	Channel Move Time	Applicable	Pass
15.407	Channel Closing Transmission Time	Applicable	Pass
15.407	Non-Occupancy Period	Applicable	Pass
15.407	Uniform Spreading	Not Required	N/A
15.407	UNII Detection Bandwidth	Not Required	N/A

## 7.8.2 DFS test result

### 7.8.2.1 Channel Move time

#### Rader Type (5260MHz)

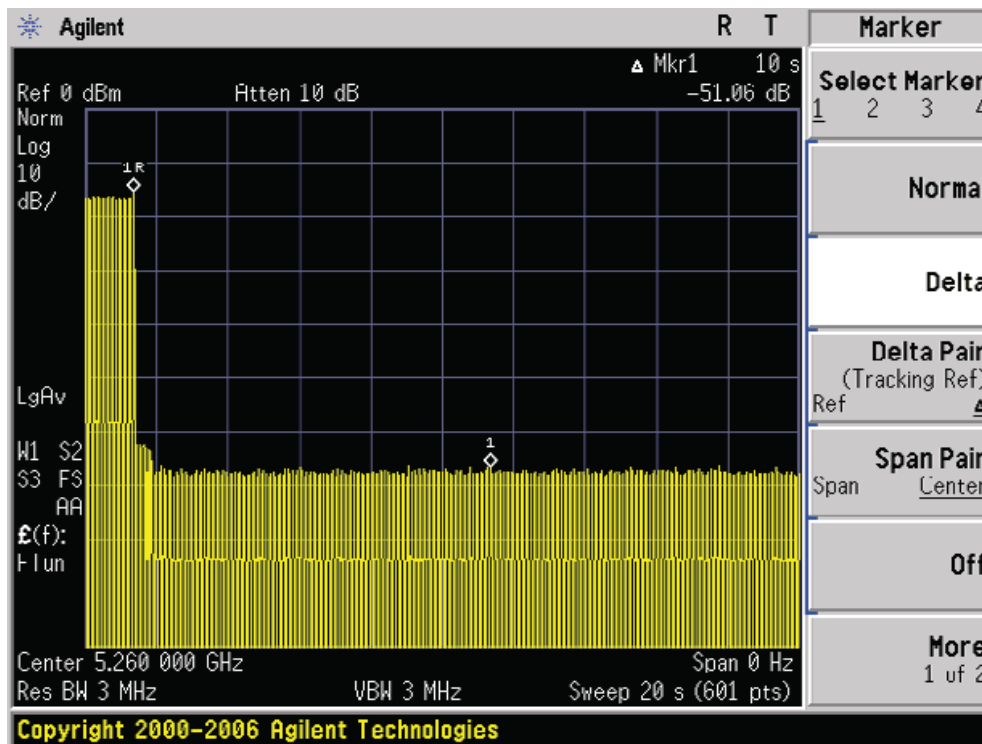

#### Rader Type (5500MHz)

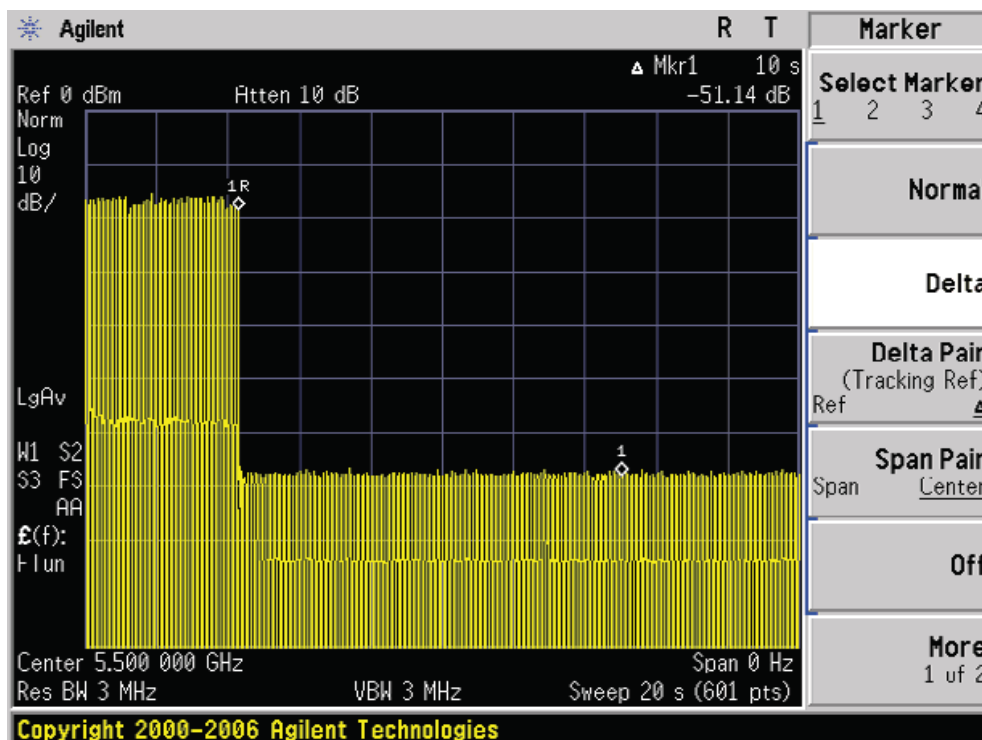



## 7.8.2.2 Channel Closing Transmission Time

Channel Closing Transmission Time 5260 MHz

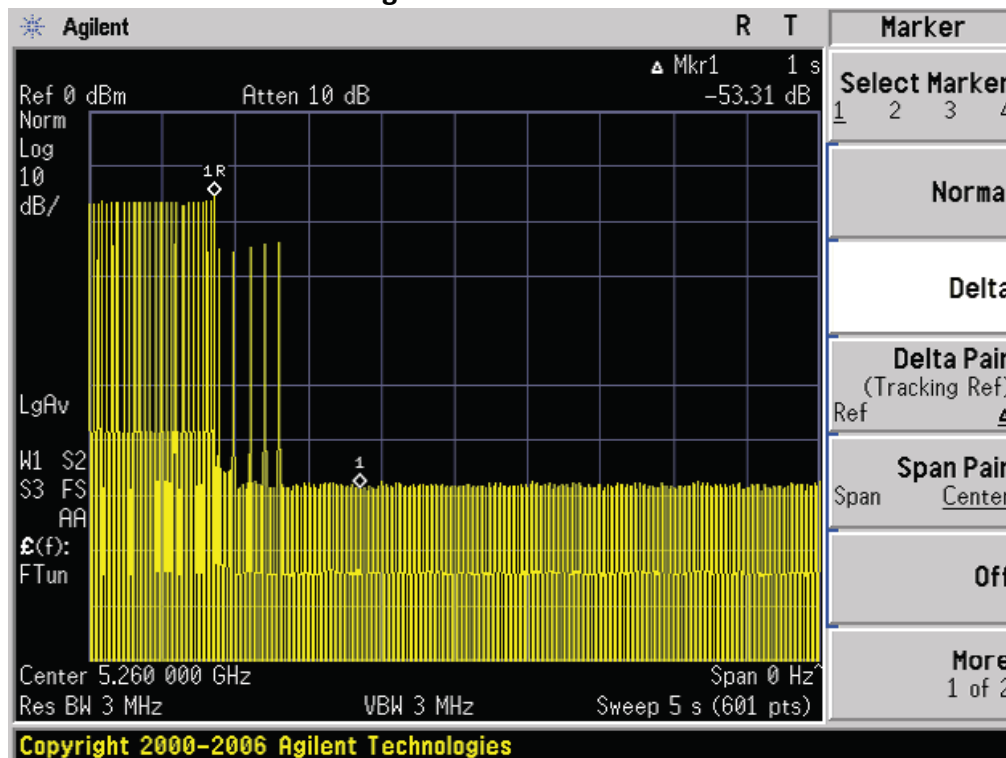

Single plus Channel Closing Transmission Time 5260 MHz

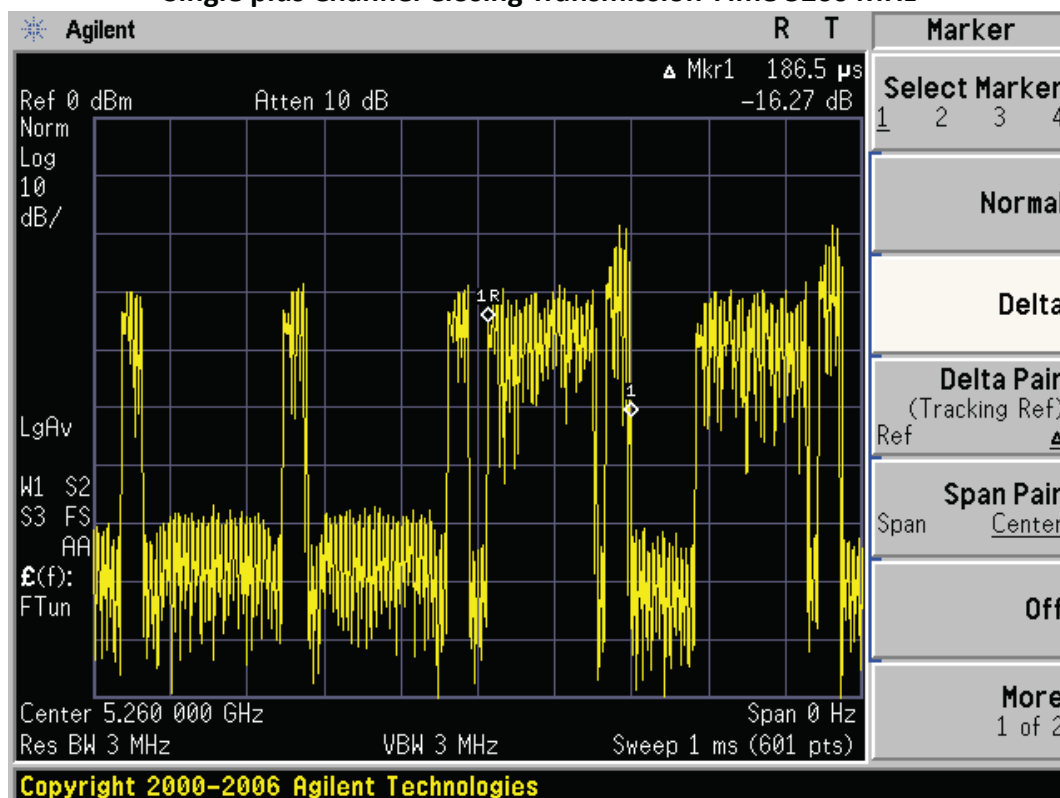

## Channel Closing Transmission Time 5500 MHz

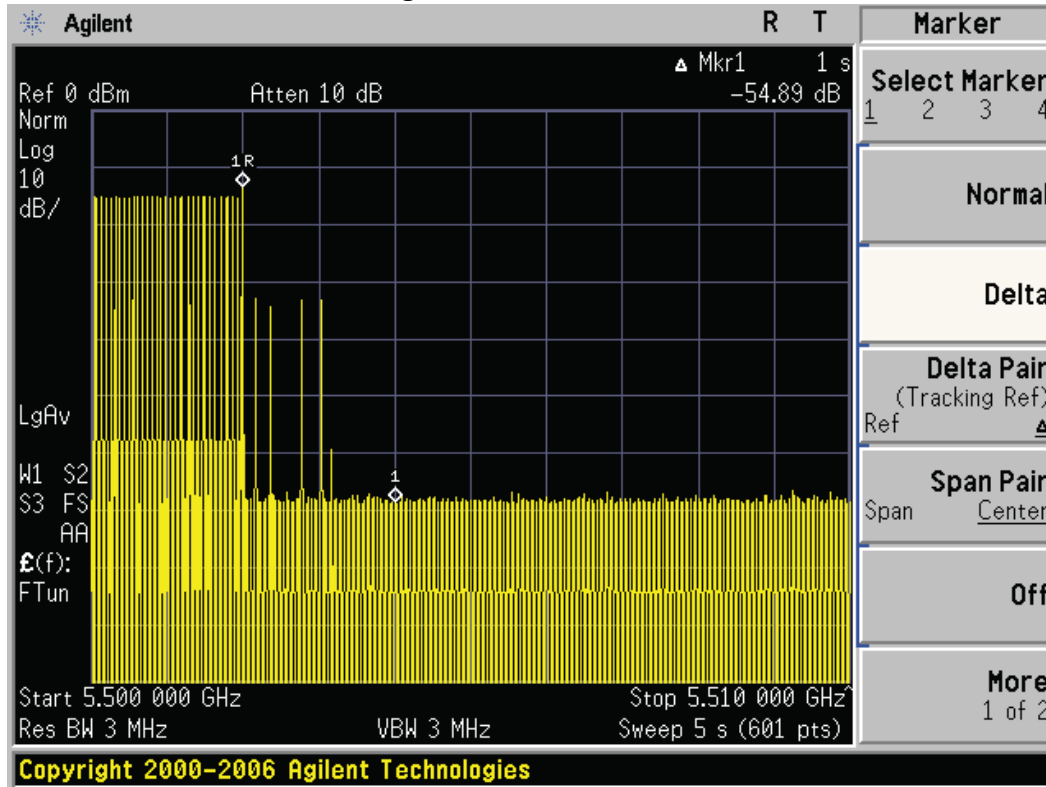

## Single plus Channel Closing Transmission Time 5500 MHz

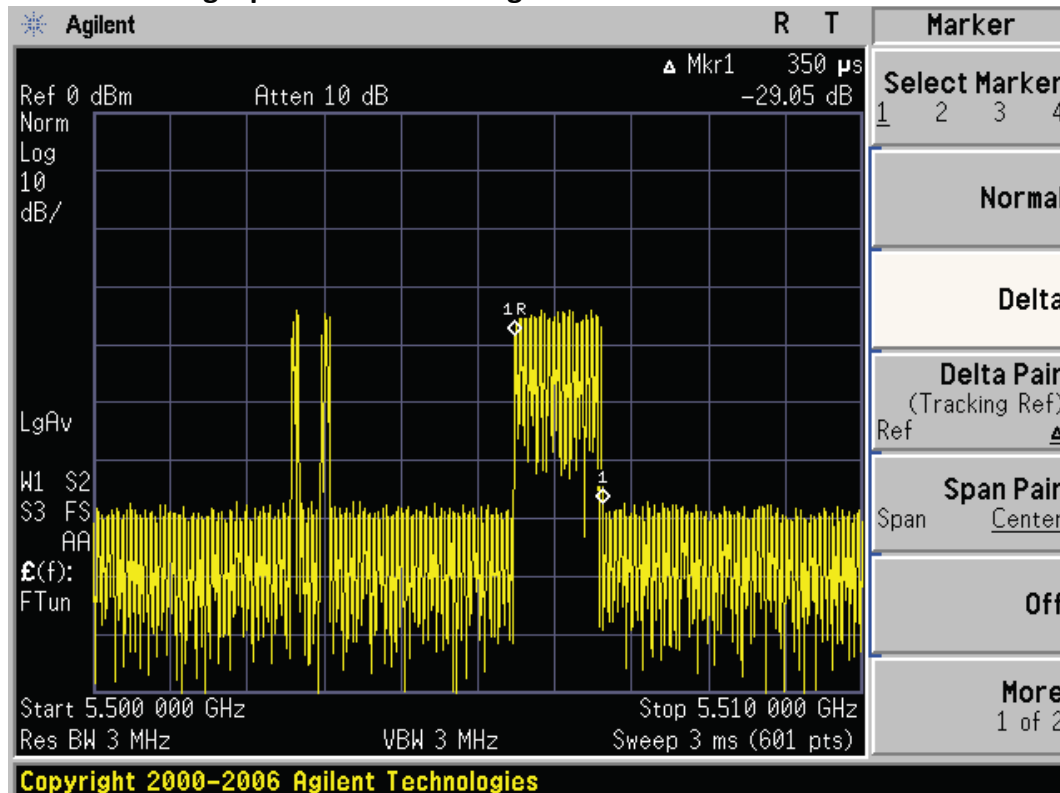

**TEST REPORT**

Mode	Channel	Frequency (Mhz)	Radar type	Single pulse (ms)	Pulse number	Total time (ms)
802.11n (HT20)	52	5260	1	0.26	5	0.1865
802.11n (HT40)	102	5500	1	0.35	5	0.35

### 7.8.2.3 Non-Occupancy Period

No transmissions were observed on the previously active channel during 30 minutes observation time for the EUT.

Non occupancy period 5260 MHz

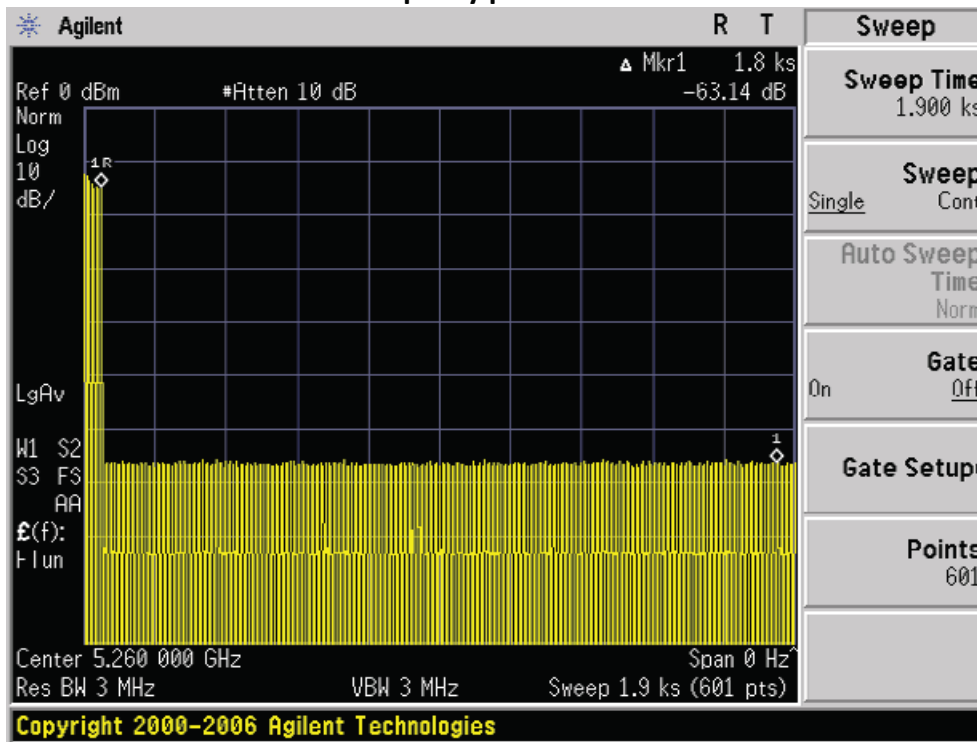

Non occupancy period 5500 MHz

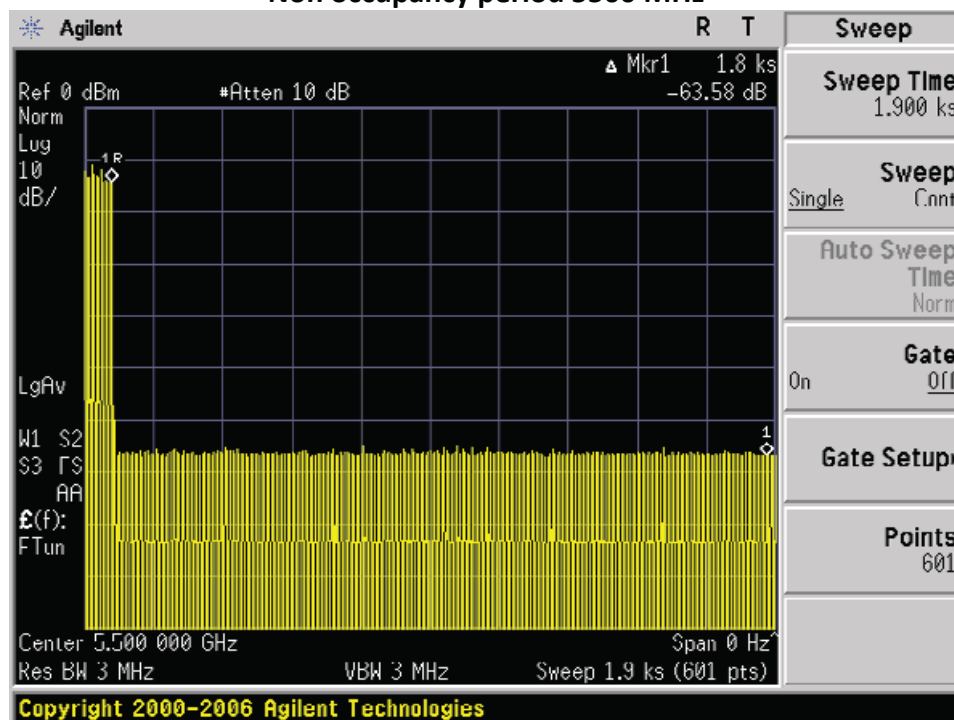

## 8.AC Power Line Conducted Emission

### 8.1 Measuring instrument setting

Receiver Function	Setting
Detector	QP
Start frequency	0.15MHz
Stop frequency	30MHz
IF bandwidth	9 kHz
Attenuation	10dB

### 8.2 Test Procedure

Step 1	Configure the EUT according to ANSI C63.10:2013. The EUT or host of EHT has to be placed 0.4 meter far from the conducting wall of the shielding room and at least 80 centimeters from any other grounded conducting surface.
Step 2	Connect EUT or host of EUT to the power mains through a line impedance stabilization network.
Step 3	All the companion devices are connected to the other LISN. The LISN should provide 50Uh/50ohms coupling impedance.
Step 4	The frequency range from 150 kHz to 30MHz was searched.
Step 5	Set the test-receiver system to peak detector and specified bandwidth with maximum hold mode.
Step 6	The measurement has to be done between each power line and ground at the power terminal.

### 8.3 Test Diagram

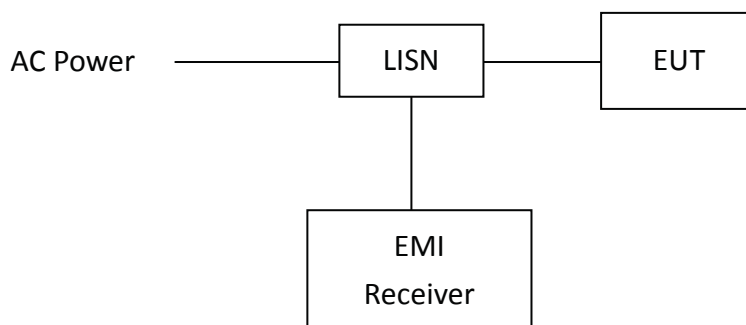

**8.4 Limit**

Frequency (MHz)	Conducted Limit (dBuV)	
	Q.P.	Ave.
0.15~0.50	66 – 56	56 – 46
0.50~5.00	56	46
5.00~30.0	60	50

**8.5 Operating Environment Condition**

Temperature (°C) :	26
Relative Humidity (%) :	68
Atmospheric Pressure (hPa) :	1010

## TEST REPORT

### 8.6 Test Results

Phase: Live Line  
 Model No.: PLTN-TC1VS  
 Test Condition: Tx mode

Frequency (MHz)	Corr. Factor (dB)	Reading QP (dBuV)	Level QP (dBuV)	Limit QP (dBuV)	Reading AV (dBuV)	Level AV (dBuV)	Limit AV (dBuV)	Margin (dB)	
								QP	AV
0.193	9.34	42.65	51.99	63.89	34.96	44.30	53.89	-11.90	-9.59
0.262	9.35	36.70	46.05	61.38	23.87	33.22	51.38	-15.33	-18.16
0.329	9.36	30.55	39.90	59.49	21.75	31.11	49.49	-19.58	-18.38
0.521	9.38	29.39	38.77	56.00	19.83	29.21	46.00	-17.23	-16.79
0.830	9.40	26.95	36.35	56.00	17.67	27.07	46.00	-19.65	-18.93
15.470	9.54	33.51	43.05	60.00	26.59	36.13	50.00	-16.95	-13.87

Remark:

1. Corr. Factor (dB) = LISN Factor (dB) + Cable Loss (dB)
2. Level (dBuV) = Corr. Factor (dB) + Reading (dBuV)
3. Margin (dB) = Level (dBuV) – Limit (dBuV)

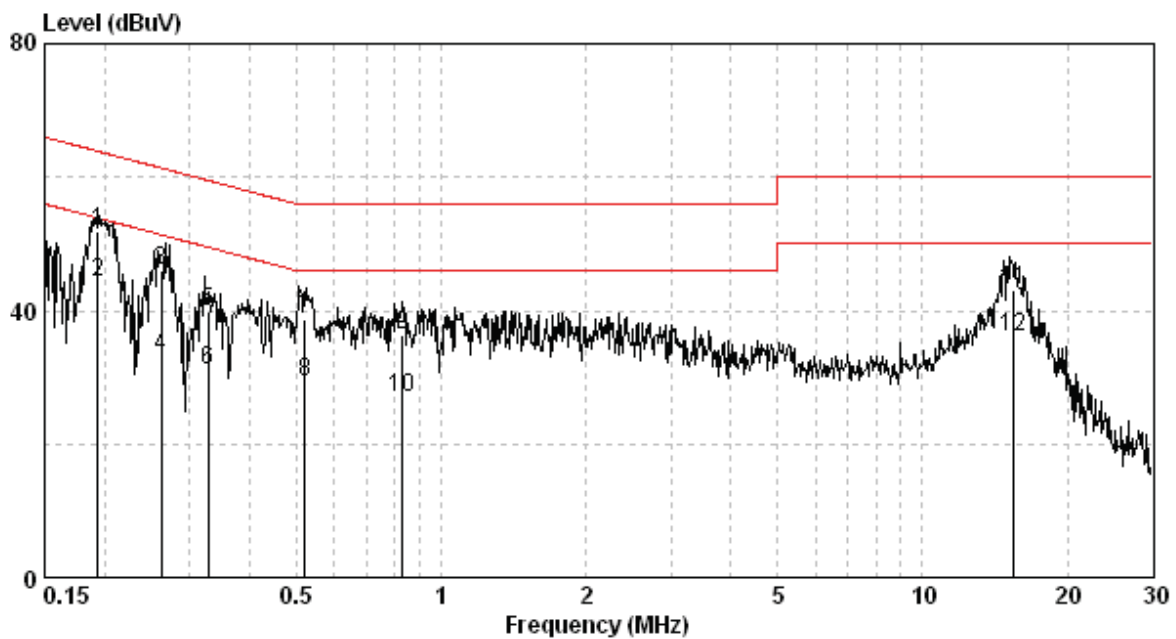

## TEST REPORT

Phase: Neutral Line  
 Model No.: PLTN-TC1VS  
 Test Condition: Tx mode

Frequency (MHz)	Corr. Factor (dB)	Reading QP (dBuV)	Level QP (dBuV)	Limit QP (dBuV)	Reading AV (dBuV)	Level AV (dBuV)	Limit AV (dBuV)	Margin (dB)	
								QP	AV
0.197	9.60	42.49	52.09	63.76	33.75	43.35	53.76	-11.66	-10.41
0.252	9.61	37.02	46.63	61.69	26.88	36.48	51.69	-15.06	-15.20
0.336	9.61	30.09	39.70	59.31	20.03	29.64	49.31	-19.61	-19.67
0.444	9.62	27.86	37.48	56.98	17.23	26.85	46.98	-19.50	-20.13
0.516	9.62	28.52	38.15	56.00	17.89	27.51	46.00	-17.85	-18.49
15.146	9.85	35.19	45.04	60.00	27.81	37.66	50.00	-14.96	-12.34

### Remark:

1. Corr. Factor (dB) = LISN Factor (dB) + Cable Loss (dB)
2. Level (dBuV) = Corr. Factor (dB) + Reading (dBuV)
3. Margin (dB) = Level (dBuV) – Limit (dBuV)

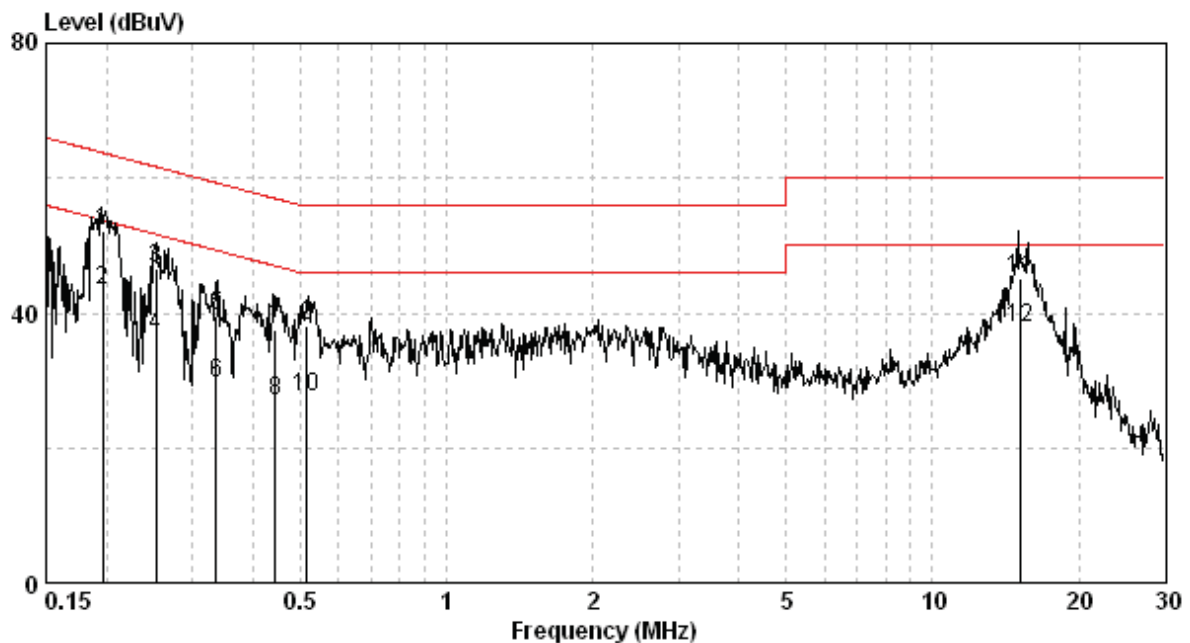



**Appendix A: Test equipment list**

Test Equipment/ Test site	Brand	Model No.	Serial No.	Calibration Date	Next Calibration Date
ESCI EMI Test Receiver	Rohde & Schwarz	ESCI	100018	2017/11/21	2018/11/20
Spectrum Analyzer	Rohde & Schwarz	FSP30	100245	2018/02/23	2019/02/22
Horn Antenna (1-18G)	SHWARZBECK	BBHA 9120 D	9120D-456	2018/01/23	2019/01/22
Horn Antenna (14-42G)	SHWARZBECK	BBHA 9170	BBHA9170159	2017/09/04	2020/09/02
Broadband Antenna	SHWARZBECK	VULB 9168	9168-172	2017/04/05	2018/04/04
Broadband Antenna	SHWARZBECK	VULB 9168	9168-172	2018/04/23	2019/04/22
Pre-Amplifier	EMC Co.	EMC12635SE	980205	2017/11/28	2018/11/27
Pre-Amplifier	MITEQ	JS4-26004000--27-8A	828825	2017/08/23	2018/08/22
Power Meter	Anritsu	ML2495A	0844001	2017/10/18	2018/10/17
Power Sensor	Anritsu	MA2411B	0738452	2017/05/23	2018/05/22
Signal Analyzer	Agilent	N9030A	MY51380492	2017/08/29	2018/08/28
966-2(A) Cable 9kHz~26.5GHz	SUHNER	SMA / EX 100	N/A	2017/08/15	2018/08/14
966-2(B) Cable 9kHz~26.5GHz	SUHNER	SUCOFLEX 104P	CB0005	2017/08/15	2018/08/14
RF Cable 9kHz~26.5GHz	SUHNER	SUCOFLEX 102	CB0006	2017/05/04	2018/05/03

Note: No Calibration Required (NCR).

Test Equipment/ Test site	Brand	Model No.	Serial No.	Calibration Date	Next Calibration Date
966-2_3m Semi-Anechoic Chamber	966_2	CEM-966_2	N/A	2017/03/29	2018/03/28
966-2_3m Semi-Anechoic Chamber	966_2	CEM-966_2	N/A	2018/03/28	2019/03/27
High Pass Filter	Wainwright	WHKX3.0/ 18G-12SS	N/A	2017/06/02	2018/06/01
Active Loop Antenna	SCHWARZBECK MESS-ELEKTRONIC	FMZB1519	1519-067	2017/03/30	2018/03/29
Active Loop Antenna	SCHWARZBECK MESS-ELEKTRONIC	FMZB1519	1519-067	2018/04/17	2019/04/16
EMI Receiver	R&S	ESCI	100059	2017/11/13	2018/11/12
Two-Line V-Network	R&S	ENV216	101159	2017/06/03	2018/06/02
Two-Line -V-Network	R&S	ESH3-Z5	825562/003	2017/09/04	2018/09/03
CON-1 Shielded Room	N/A	N/A	N/A	NCR	NCR
CON-1 Cable	SUHNER	SUCOFLEX-104	26438414	2018/05/03	2019/05/02
Test software	Audix	e3	4.20040112L	NCR	NCR

Note: No Calibration Required (NCR).

## Appendix B: Measurement Uncertainty

This uncertainty represents an expanded uncertainty expressed at approximately the 95 % confidence level using a coverage factor of  $k=2$ .

Item	Uncertainty
Vertically polarized radiated disturbances from 30MHz~1GHz in a semi-anechoic chamber at a distance of 3m	5.14 dB
Horizontally polarized radiated disturbances from 30MHz~1GHz in a semi-anechoic chamber at a distance of 3m	5.22 dB
Vertically polarized Radiated disturbances from 1GHz~18GHz in a semi-anechoic chamber at a distance of 3m	3.64 dB
Horizontally polarized Radiated disturbances from 1GHz~18GHz in a semi-anechoic chamber at a distance of 3m	3.64 dB
Vertically polarized Radiated disturbances from 18GHz~40GHz in a semi-anechoic chamber at a distance of 3m	2.68 dB
Horizontally polarized Radiated disturbances from 18GHz~40GHz in a semi-anechoic chamber at a distance of 3m	2.68 dB
Radiated disturbances from 9kHz~30MHz in a semi-anechoic chamber at a distance of 3m	3.54 dB
Emission on the Band Edge Test	3.64 dB
Minimum 6dB Bandwidth	0.85 dB
Maximum Conducted Output Power	0.42 dB
Power Spectral Density	0.85 dB
Emissions In Non-Restricted Frequency Bands	0.85 dB
AC Power Line Conducted Emission	2.48 dB