

# ELECTROMAGNETIC EMISSIONS COMPLIANCE REPORT



**Applicant:** Peloton Interactive Inc.  
125 W 25th Street, 11 FL, New York, NY, 10001, USA

**Product Name:** Peloton Console

**Brand Name:** Peloton

**Model No.:** PLTN-RB1VQ-2

**Model Difference:** N/A

**Report Number:** E2/2021/70053

**FCC ID** 2AA3N-RB1VQ2

**IC:** 21377-RB1VQ2

**Issue Date:** August 27, 2021

**Date of Test:** July 26, 2021 ~ August 25, 2021

**Date of EUT Received:** July 13, 2021

Approved By \_\_\_\_\_

Jay Lin

## We hereby certify that:

The above equipment was tested by SGS Taiwan Ltd. Central RF Lab The test data, data evaluation, test procedures, and equipment configurations shown in this report were made in accordance with the procedures given in ANSI C63.10:2013 and the energy emitted by the sample EUT comply with FCC rule part §15.247, ISSED RSS-247.

Unless otherwise stated the results shown in this test report refer only to the sample(s) tested and such sample(s) are retained for 90 days only.

除非另有說明，此報告結果僅對測試之樣品負責，同時此樣品僅保留90天。本報告未經本公司書面許可，不可部份複製。

This document is issued by the Company subject to its General Conditions of Service printed overleaf, available on request or accessible at <http://www.sgs.com.tw/Terms-and-Conditions> and for electronic format documents, subject to Terms and Conditions for Electronic Documents at <http://www.sgs.com.tw/Terms-and-Conditions>. Attention is drawn to the limitation of liability, indemnification and jurisdiction issues defined therein. Any holder of this document is advised that information contained hereon reflects the Company's findings at the time of its intervention only and within the limits of Client's instructions, if any. The Company's sole responsibility is to its Client and this document does not exonerate parties to a transaction from exercising all their rights and obligations under the transaction documents. This document cannot be reproduced except in full, without prior written approval of the Company. Any unauthorized alteration, forgery or falsification of the content or appearance of this document is unlawful and offenders may be prosecuted to the fullest extent of the law.

## Revision History

Report Number	Revision	Description	Issue Date	Revised By
E2/2021/70052	00	Original	August 27, 2021	Yuri Tsai

Unless otherwise stated the results shown in this test report refer only to the sample(s) tested and such sample(s) are retained for 90 days only.

除非另有說明，此報告結果僅對測試之樣品負責，同時此樣品僅保留90天。本報告未經本公司書面許可，不可部份複製。

This document is issued by the Company subject to its General Conditions of Service printed overleaf, available on request or accessible at <http://www.sgs.com.tw/Terms-and-Conditions> and for electronic format documents, subject to Terms and Conditions for Electronic Documents at <http://www.sgs.com.tw/Terms-and-Conditions>. Attention is drawn to the limitation of liability, indemnification and jurisdiction issues defined therein. Any holder of this document is advised that information contained hereon reflects the Company's findings at the time of its intervention only and within the limits of Client's instructions, if any. The Company's sole responsibility is to its Client and this document does not exonerate parties to a transaction from exercising all their rights and obligations under the transaction documents. This document cannot be reproduced except in full, without prior written approval of the Company. Any unauthorized alteration, forgery or falsification of the content or appearance of this document is unlawful and offenders may be prosecuted to the fullest extent of the law.

## Contents

<b>1</b>	<b>GENERAL INFORMATION .....</b>	<b>4</b>
<b>2</b>	<b>SYSTEM TEST CONFIGURATION .....</b>	<b>6</b>
<b>3</b>	<b>SUMMARY OF TEST RESULTS.....</b>	<b>9</b>
<b>4</b>	<b>DESCRIPTION OF TEST MODES .....</b>	<b>10</b>
<b>5</b>	<b>MEASUREMENT UNCERTAINTY .....</b>	<b>12</b>
<b>6</b>	<b>CONDUCTED EMISSION TEST .....</b>	<b>13</b>
<b>7</b>	<b>PEAK OUTPUT POWER MEASUREMENT.....</b>	<b>17</b>
<b>8</b>	<b>EMISSION BANDWIDTH MEASUREMENT .....</b>	<b>21</b>
<b>9</b>	<b>CONDUCTED BAND EDGES AND SPURIOUS EMISSION MEASUREMENT .....</b>	<b>28</b>
<b>10</b>	<b>RADIATED BANDEDGE AND SPURIOUS EMISSION MEASUREMENT .....</b>	<b>34</b>
<b>11</b>	<b>FREQUENCY SEPARATION .....</b>	<b>70</b>
<b>12</b>	<b>NUMBER OF HOPPING FREQUENCY .....</b>	<b>74</b>
<b>13</b>	<b>TIME OF OCCUPANCY (DWELL TIME).....</b>	<b>77</b>
<b>14</b>	<b>ANTENNA REQUIREMENT .....</b>	<b>84</b>

Unless otherwise stated the results shown in this test report refer only to the sample(s) tested and such sample(s) are retained for 90 days only.

除非另有說明，此報告結果僅對測試之樣品負責，同時此樣品僅保留90天。本報告未經本公司書面許可，不可部份複製。

This document is issued by the Company subject to its General Conditions of Service printed overleaf, available on request or accessible at <http://www.sgs.com.tw/Terms-and-Conditions> and for electronic format documents, subject to Terms and Conditions for Electronic Documents at <http://www.sgs.com.tw/Terms-and-Conditions>. Attention is drawn to the limitation of liability, indemnification and jurisdiction issues defined therein. Any holder of this document is advised that information contained hereon reflects the Company's findings at the time of its intervention only and within the limits of Client's instructions, if any. The Company's sole responsibility is to its Client and this document does not exonerate parties to a transaction from exercising all their rights and obligations under the transaction documents. This document cannot be reproduced except in full, without prior written approval of the Company. Any unauthorized alteration, forgery or falsification of the content or appearance of this document is unlawful and offenders may be prosecuted to the fullest extent of the law.

## 1 GENERAL INFORMATION

### 1.1 Product Description

Product Name:	Peloton Console
Brand Name:	Peloton
Model No.:	PLTN-RB1VQ-2
Model Difference:	N/A
Hardware Version:	N/A
Firmware Version:	N/A
EUT Series No.:	Conducted: QAPLBK2104190030, Radiated: QAPLBK2104190019
Power Supply:	12Vdc from power cord

### 1.2 RF Specification

Radio Technology:	BT BR+EDR
Channel number:	79 channels
Modulation type:	GFSK + $\pi/4$ DQPSK + 8DPSK
Transmit Power:	10.58dBm
Frequency Range:	2.402GHz – 2.480GHz
Dwell Time:	$\leq$ 0.4s

### 1.3 Antenna Designation

Antenna Type	Supplier	Antenna Part No.	Freq. (MHz)	Peak Antenna Gain (dBi)
PIFA	ACON	APP8P-100003	2402-2480	1.58

Note: Antenna information is provided by the applicant.

Unless otherwise stated the results shown in this test report refer only to the sample(s) tested and such sample(s) are retained for 90 days only.

除非另有說明，此報告結果僅對測試之樣品負責，同時此樣品僅保留90天。本報告未經本公司書面許可，不可部份複製。

This document is issued by the Company subject to its General Conditions of Service printed overleaf, available on request or accessible at <http://www.sgs.com.tw/Terms-and-Conditions> and for electronic format documents, subject to Terms and Conditions for Electronic Documents at <http://www.sgs.com.tw/Terms-and-Conditions>. Attention is drawn to the limitation of liability, indemnification and jurisdiction issues defined therein. Any holder of this document is advised that information contained hereon reflects the Company's findings at the time of its intervention only and within the limits of Client's instructions, if any. The Company's sole responsibility is to its Client and this document does not exonerate parties to a transaction from exercising all their rights and obligations under the transaction documents. This document cannot be reproduced except in full, without prior written approval of the Company. Any unauthorized alteration, forgery or falsification of the content or appearance of this document is unlawful and offenders may be prosecuted to the fullest extent of the law.

**1.4 Test Methodology of Applied Standards**

FCC Part 15, Subpart C §15.247  
 FCC KDB 558074 D01 15.247 Meas. Guidance v05r02  
 RSS-247 issue 2 Feb. 2017  
 RSS-Gen Issue 5 Feb. 2021  
 ANSI C63.10:2013

**1.5 Test Facility**

Laboratory	Test Site Address	Test Site Name	FCC Designation number	IC CAB identifier
SGS Taiwan Ltd. Central RF Lab. (TAF code 3702)	No.134, Wu Kung Road, New Taipei Industrial Park, Wuku District, New Taipei City, Taiwan.	SAC 1	TW0027	TW3702
		SAC 3		
		Conduction 1		
		Conducted 1		
		Conducted 2		
		Conducted 3		
		Conducted 4		
		Conducted 5		
	Conducted 6			
	No.2, Keji 1st Rd., Guishan District, Taoyuan City, Taiwan 333	Conduction C	TW0028	
		SAC C		
		SAC D		
		SAC G		
		Conducted A		
		Conducted B		
		Conducted C		
		Conducted D		
		Conducted E		
Conducted F				
Conducted G				

**Note:** Test site name is remarked on the equipment list in each section of this report as an indication where measurements occurred in specific test site and address.

**1.6 Special Accessories**

There is no special accessory used while test was conducted.

**1.7 Equipment Modifications**

There was no modification incorporated into the EUT.

Unless otherwise stated the results shown in this test report refer only to the sample(s) tested and such sample(s) are retained for 90 days only.  
 除非另有說明，此報告結果僅對測試之樣品負責，同時此樣品僅保留90天。本報告未經本公司書面許可，不可部份複製。

This document is issued by the Company subject to its General Conditions of Service printed overleaf, available on request or accessible at <http://www.sgs.com.tw/Terms-and-Conditions> and for electronic format documents, subject to Terms and Conditions for Electronic Documents at <http://www.sgs.com.tw/Terms-and-Conditions>. Attention is drawn to the limitation of liability, indemnification and jurisdiction issues defined therein. Any holder of this document is advised that information contained hereon reflects the Company's findings at the time of its intervention only and within the limits of Client's instructions, if any. The Company's sole responsibility is to its Client and this document does not exonerate parties to a transaction from exercising all their rights and obligations under the transaction documents. This document cannot be reproduced except in full, without prior written approval of the Company. Any unauthorized alteration, forgery or falsification of the content or appearance of this document is unlawful and offenders may be prosecuted to the fullest extent of the law.

## 2 SYSTEM TEST CONFIGURATION

### 2.1 EUT Configuration

The EUT configuration for testing is installed on RF field strength measurement to meet the Commissions requirement and operating in a manner which intends to maximize its emission characteristics in a continuous normal application.

### 2.2 EUT Exercise

An engineering test mode (software/firmware) that applicant provided was utilized to manipulate the EUT into transmit, selection of the test channel, and modulation scheme.

### 2.3 Test Procedure

#### 2.3.1 Conducted Emissions

The EUT is placed on a table which is 0.8 m above ground plane. Conducted emissions from the EUT measured in the frequency range between 0.15 MHz and 30MHz. The CISPR Quasi-Peak and Average detector mode is employed. The two LISNs provide 50uH/50 ohm of coupling impedance for the measuring instrument. Both lines of the power mains connected to the EUT were checked for maximum conducted interference.

#### 2.3.2 Conducted Test (RF)

The active antenna port of the unlicensed wireless device is connected to the spectrum analyzer with attenuator to protect the instrumentation. If a second antenna port is available, it is tested at one operating frequency, with other port(s) appropriately terminated, to verify it has similar output characteristics as the fully tested port.

#### 2.3.3 Radiated Emissions

The EUT is placed on a turn table. For emissions testing at or below 1 GHz, the table height shall be 0.8 m above the reference ground plane. For emission measurements above 1 GHz, the table height shall be 1.5 m. The turn table shall rotate 360 degrees to determine the position of maximum emission level. EUT is set 3m away from the receiving antenna which varied from 1m to 4m to find out the highest emission. And also, each emission was to be maximized by changing the polarization of receiving antenna both horizontal and vertical. In order to find out the max. emission, the relative positions of this transmitter (EUT) was rotated through three orthogonal axes and measurement procedures for electric field radiated emissions above 1 GHz the EUT measurement is to be made "while keeping the antenna in the 'cone of radiation' from that area and pointed at the area both in azimuth and elevation, with polarization oriented for maximum response." is still within the 3dB illumination BW of the measurement antenna.

Unless otherwise stated the results shown in this test report refer only to the sample(s) tested and such sample(s) are retained for 90 days only.

除非另有說明，此報告結果僅對測試之樣品負責，同時此樣品僅保留90天。本報告未經本公司書面許可，不可部份複製。

This document is issued by the Company subject to its General Conditions of Service printed overleaf, available on request or accessible at <http://www.sgs.com.tw/Terms-and-Conditions> and for electronic format documents, subject to Terms and Conditions for Electronic Documents at <http://www.sgs.com.tw/Terms-and-Conditions>. Attention is drawn to the limitation of liability, indemnification and jurisdiction issues defined therein. Any holder of this document is advised that information contained hereon reflects the Company's findings at the time of its intervention only and within the limits of Client's instructions, if any. The Company's sole responsibility is to its Client and this document does not exonerate parties to a transaction from exercising all their rights and obligations under the transaction documents. This document cannot be reproduced except in full, without prior written approval of the Company. Any unauthorized alteration, forgery or falsification of the content or appearance of this document is unlawful and offenders may be prosecuted to the fullest extent of the law.

## 2.4 Measurement Results Explanation Example

### 2.4.1 Radiated Emission Test Sites For Measurements From 9 kHz To 30 MHz

Radiated emission below 30MHz is measured in a 9m\*9m\*6m semi-anechoic chamber, the measurements correspond to those obtained at an open-field test site.

There is a comparison data of both open-field test site and semi-Anechoic chamber, and the result came out very similar.

### 2.4.2 For all conducted test items:

The offset level is set in the spectrum analyzer to compensate the RF cable loss and attenuation factor between EUT conducted port and spectrum analyzer. With the offset compensation, the spectrum analyzer reading level is exactly EUT RF output level.

Unless otherwise stated the results shown in this test report refer only to the sample(s) tested and such sample(s) are retained for 90 days only.

除非另有說明，此報告結果僅對測試之樣品負責，同時此樣品僅保留90天。本報告未經本公司書面許可，不可部份複製。

This document is issued by the Company subject to its General Conditions of Service printed overleaf, available on request or accessible at <http://www.sgs.com.tw/Terms-and-Conditions> and for electronic format documents, subject to Terms and Conditions for Electronic Documents at <http://www.sgs.com.tw/Terms-and-Conditions>. Attention is drawn to the limitation of liability, indemnification and jurisdiction issues defined therein. Any holder of this document is advised that information contained hereon reflects the Company's findings at the time of its intervention only and within the limits of Client's instructions, if any. The Company's sole responsibility is to its Client and this document does not exonerate parties to a transaction from exercising all their rights and obligations under the transaction documents. This document cannot be reproduced except in full, without prior written approval of the Company. Any unauthorized alteration, forgery or falsification of the content or appearance of this document is unlawful and offenders may be prosecuted to the fullest extent of the law.

## 2.5 Test Configuration

Fig. 2-1 Conducted (Antenna Port) Emission Configuration



Fig 2-2 Radiated Emission

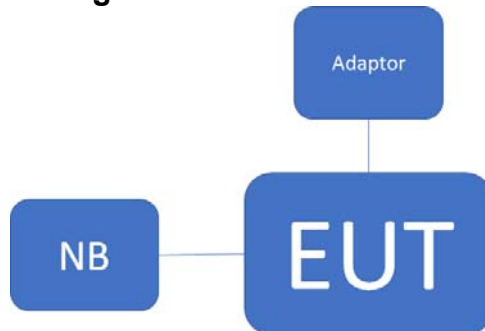
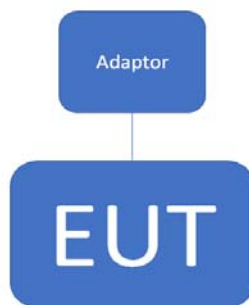

Fig 2-3 Conduction (AC Power Line) Radiated Emission



## 2.6 Control Unit(s)

Item	Equipment	Mfr/Brand	Model/Type No.	Series No.
1	Bluetooth Test Software	N/A	N/A	N/A
2	Notebook	Lenovo	L440	P0000367

Unless otherwise stated the results shown in this test report refer only to the sample(s) tested and such sample(s) are retained for 90 days only.

除非另有說明，此報告結果僅對測試之樣品負責，同時此樣品僅保留90天。本報告未經本公司書面許可，不可部份複製。

This document is issued by the Company subject to its General Conditions of Service printed overleaf, available on request or accessible at <http://www.sgs.com.tw/Terms-and-Conditions> and for electronic format documents, subject to Terms and Conditions for Electronic Documents at <http://www.sgs.com.tw/Terms-and-Conditions>. Attention is drawn to the limitation of liability, indemnification and jurisdiction issues defined therein. Any holder of this document is advised that information contained hereon reflects the Company's findings at the time of its intervention only and within the limits of Client's instructions, if any. The Company's sole responsibility is to its Client and this document does not exonerate parties to a transaction from exercising all their rights and obligations under the transaction documents. This document cannot be reproduced except in full, without prior written approval of the Company. Any unauthorized alteration, forgery or falsification of the content or appearance of this document is unlawful and offenders may be prosecuted to the fullest extent of the law.



### 3 SUMMARY OF TEST RESULTS

FCC Rules	IC Rules	Description Of Test	Result
§15.207(a)	RSS-Gen §8.8	AC Power Line Conducted Emission	Compliant
§15.247(b)(1)	RSS-247 §5.4 b	Peak Output Power	Compliant
§15.247(a)(1)	RSS-247 §5.1 b RSS-Gen §6.7	Emission Bandwidth	Compliant
§15.205 §15.209 §15.247(d)	RSS-247 §5.5 RSS-Gen §8.9 RSS-Gen §8.10	Conducted & Radiated Band Edge and Spurious Emission	Compliant
§15.247(a)(1)	RSS-247 §5.1 b	Frequency Separation	Compliant
§15.247(a)(1)(iii)	RSS-247 §5.1 d	Number of hopping frequency Time of Occupancy	Compliant
§15.203	N/A	Antenna Requirement	Compliant

Unless otherwise stated the results shown in this test report refer only to the sample(s) tested and such sample(s) are retained for 90 days only.

除非另有說明，此報告結果僅對測試之樣品負責，同時此樣品僅保留90天。本報告未經本公司書面許可，不可部份複製。

This document is issued by the Company subject to its General Conditions of Service printed overleaf, available on request or accessible at <http://www.sgs.com.tw/Terms-and-Conditions> and for electronic format documents, subject to Terms and Conditions for Electronic Documents at <http://www.sgs.com.tw/Terms-and-Conditions>. Attention is drawn to the limitation of liability, indemnification and jurisdiction issues defined therein. Any holder of this document is advised that information contained hereon reflects the Company's findings at the time of its intervention only and within the limits of Client's instructions, if any. The Company's sole responsibility is to its Client and this document does not exonerate parties to a transaction from exercising all their rights and obligations under the transaction documents. This document cannot be reproduced except in full, without prior written approval of the Company. Any unauthorized alteration, forgery or falsification of the content or appearance of this document is unlawful and offenders may be prosecuted to the fullest extent of the law.

## 4 DESCRIPTION OF TEST MODES

### 4.1 Operated in 2400 ~ 2483.5MHz Band

79 channels are provided for Bluetooth

ITEM	FREQUENCY	ITEM	FREQUENCY	ITEM	FREQUENCY	ITEM	FREQUENCY
1	2402 MHz	21	2422 MHz	41	2442 MHz	71	2462 MHz
2	2403 MHz	22	2423 MHz	42	2443 MHz	72	2463 MHz
3	2404 MHz	23	2424 MHz	43	2444 MHz	73	2464 MHz
4	2405 MHz	24	2425 MHz	44	2445 MHz	74	2465 MHz
5	2406 MHz	25	2426 MHz	45	2446 MHz	75	2466 MHz
6	2407 MHz	26	2427 MHz	46	2447 MHz	76	2467 MHz
7	2408 MHz	27	2428 MHz	47	2448 MHz	77	2468 MHz
8	2409 MHz	28	2429 MHz	48	2449 MHz	78	2469 MHz
9	2410 MHz	29	2430 MHz	49	2450 MHz	79	2470 MHz
10	2411 MHz	30	2431 MHz	50	2451 MHz	70	2471 MHz
11	2412 MHz	31	2432 MHz	51	2452 MHz	71	2472 MHz
12	2413 MHz	32	2433 MHz	52	2453 MHz	72	2473 MHz
13	2414 MHz	33	2434 MHz	53	2454 MHz	73	2474 MHz
14	2415 MHz	34	2435 MHz	54	2455 MHz	74	2475 MHz
15	2416 MHz	35	2436 MHz	55	2456 MHz	75	2476 MHz
16	2417 MHz	36	2437 MHz	56	2457 MHz	76	2477 MHz
17	2418 MHz	37	2438 MHz	57	2458 MHz	77	2478 MHz
18	2419 MHz	38	2439 MHz	58	2459 MHz	78	2479 MHz
19	2420 MHz	39	2440 MHz	59	2460 MHz	79	2480 MHz
20	2421 MHz	40	2441 MHz	60	2461 MHz		

Unless otherwise stated the results shown in this test report refer only to the sample(s) tested and such sample(s) are retained for 90 days only.

除非另有說明，此報告結果僅對測試之樣品負責，同時此樣品僅保留90天。本報告未經本公司書面許可，不可部份複製。

This document is issued by the Company subject to its General Conditions of Service printed overleaf, available on request or accessible at <http://www.sgs.com.tw/Terms-and-Conditions> and for electronic format documents, subject to Terms and Conditions for Electronic Documents at <http://www.sgs.com.tw/Terms-and-Conditions>. Attention is drawn to the limitation of liability, indemnification and jurisdiction issues defined therein. Any holder of this document is advised that information contained hereon reflects the Company's findings at the time of its intervention only and within the limits of Client's instructions, if any. The Company's sole responsibility is to its Client and this document does not exonerate parties to a transaction from exercising all their rights and obligations under the transaction documents. This document cannot be reproduced except in full, without prior written approval of the Company. Any unauthorized alteration, forgery or falsification of the content or appearance of this document is unlawful and offenders may be prosecuted to the fullest extent of the law.

#### 4.2 The Worst Test Modes and Channel Details

- 1 The EUT has been tested under operating condition.
- 2 Test program used to control the EUT for staying in continuous transmitting and receiving mode is programmed.
- 3 The field strength of radiation emission was measured as EUT three orthogonal planes, E1 / E2 / H, are positioned to pre-scan the emission generating the highest one. The worst position is tested and recorded.
- 4 Investigation has been done on all the possible configurations for searching the worst case.

MODE	AVAILABLE CHANNEL	TESTED CHANNEL	MODULATION	PACKET TYPE
<b>RADIATED EMISSION TEST (BELOW 1 GHz)</b>				
Bluetooth	0 to 78	39	GFSK/8-DPSK	DH5/3DH5
<b>RADIATED EMISSION TEST (ABOVE 1 GHz)</b>				
Bluetooth	0 to 78	0,39,78	GFSK/8-DPSK	DH5/3DH5
<p><b>Note:</b> The field strength of radiation emission was measured as EUT stand-up position (H mode) and lie down position (E1, E2 mode) for channel Low, Mid and High, the worst case position was reported.</p>				

<b>ANTENNA PORT CONDUCTED TEST</b>				
MODE	AVAILABLE CHANNEL	TESTED CHANNEL	MODULATION	PACKET TYPE
<b>Peak Output Power, 20dB Band Width</b>				
Bluetooth	0 to 78	0,39,78	GFSK	DH5
	0 to 78	0,39,78	$\pi/4$ -DQPSK	2DH5
	0 to 78	0,39,78	8-DPSK	3DH5
<b>Band Edge</b>				
Bluetooth	0 to 78	0,78	GFSK/8-DPSK	DH5/3DH5
<b>Frequency Separation</b>				
Bluetooth	0 to 78	0,1,2,38,39,40,76,77,78	GFSK/8-DPSK	DH5/3DH5
<b>Number of hopping frequency</b>				
Bluetooth	0 to 78	0 to 78	GFSK/8-DPSK	DH5/3DH5
<b>Time of Occupancy(Dwell time)</b>				
Bluetooth	0 to 78	39	GFSK	DH1/DH3/DH5
			$\pi/4$ -DQPSK	2DH1/2DH3/2DH5
			8-DPSK	3DH1/3DH3/3DH5

Unless otherwise stated the results shown in this test report refer only to the sample(s) tested and such sample(s) are retained for 90 days only.

除非另有說明，此報告結果僅對測試之樣品負責，同時此樣品僅保留90天。本報告未經本公司書面許可，不可部份複製。

This document is issued by the Company subject to its General Conditions of Service printed overleaf, available on request or accessible at <http://www.sgs.com.tw/Terms-and-Conditions> and for electronic format documents, subject to Terms and Conditions for Electronic Documents at <http://www.sgs.com.tw/Terms-and-Conditions>. Attention is drawn to the limitation of liability, indemnification and jurisdiction issues defined therein. Any holder of this document is advised that information contained hereon reflects the Company's findings at the time of its intervention only and within the limits of Client's instructions, if any. The Company's sole responsibility is to its Client and this document does not exonerate parties to a transaction from exercising all their rights and obligations under the transaction documents. This document cannot be reproduced except in full, without prior written approval of the Company. Any unauthorized alteration, forgery or falsification of the content or appearance of this document is unlawful and offenders may be prosecuted to the fullest extent of the law.

## 5 MEASUREMENT UNCERTAINTY

Test Items	Uncertainty
AC Power Line Conducted Emission	+/- 2.34 dB
Peak Output Power	+/- 1 dB
Emission Bandwidth	+/- 1.53 Hz
100 kHz Bandwidth Of Frequency Band Edges	+/- 1.69 dB
Frequency Separation	+/- 1.53 Hz
Number of hopping frequency	+/- 1.53 Hz
Time of Occupancy	+/- 1.53 Hz
Temperature	+/- 0.4 °C
Humidity	+/- 3.5 %
DC / AC Power Source	+/- 1 %

Radiated Spurious Emission Measurement Uncertainty		
<b>Polarization: Vertical</b>	+/- 2.64 dB	9kHz~30MHz
	+/- 4.93 dB	30MHz - 1000MHz
	+/- 4.81 dB	1GHz - 18GHz
	+/- 4.52 dB	18GHz - 40GHz
<b>Polarization: Horizontal</b>	+/- 2.64 dB	9kHz~30MHz
	+/- 4.45 dB	30MHz - 1000MHz
	+/- 4.81 dB	1GHz - 18GHz
	+/- 4.52 dB	18GHz - 40GHz

### Note:

1. This uncertainty represents an expanded uncertainty expressed at approximately the 95% confidence level using a coverage factor of k=2.
2. The conformity assessment statement in this report is based solely on the test results, measurement uncertainty is excluded.

Unless otherwise stated the results shown in this test report refer only to the sample(s) tested and such sample(s) are retained for 90 days only.

除非另有說明，此報告結果僅對測試之樣品負責，同時此樣品僅保留90天。本報告未經本公司書面許可，不可部份複製。

This document is issued by the Company subject to its General Conditions of Service printed overleaf, available on request or accessible at <http://www.sgs.com.tw/Terms-and-Conditions> and for electronic format documents, subject to Terms and Conditions for Electronic Documents at <http://www.sgs.com.tw/Terms-and-Conditions>. Attention is drawn to the limitation of liability, indemnification and jurisdiction issues defined therein. Any holder of this document is advised that information contained hereon reflects the Company's findings at the time of its intervention only and within the limits of Client's instructions, if any. The Company's sole responsibility is to its Client and this document does not exonerate parties to a transaction from exercising all their rights and obligations under the transaction documents. This document cannot be reproduced except in full, without prior written approval of the Company. Any unauthorized alteration, forgery or falsification of the content or appearance of this document is unlawful and offenders may be prosecuted to the fullest extent of the law.

## 6 CONDUCTED EMISSION TEST

### 6.1 Standard Applicable

Frequency within 150 kHz to 30MHz shall not exceed the limit table as below.

Frequency range MHz	Limits dB(uV)	
	Quasi-peak	Average
0.15 to 0.50	66 to 56	56 to 46
0.50 to 5	56	46
5 to 30	60	50

Note

- The lower limit shall apply at the transition frequencies
- The limit decreases linearly with the logarithm of the frequency in the range 0.15 MHz to 0.50 MHz.

### 6.2 Measurement Equipment Used

Radiated Emission Test Site: Conduction C					
EQUIPMENT TYPE	MFR	MODEL NUMBER	SERIAL NUMBER	LAST CAL.	CAL DUE.
Test Software	audix	e3	Ver. 6.11-20180419c	N.C.R	N.C.R
LISN	SCHWARZBECK Mess-Elektronik	NSLK8127	973	03/25/2021	03/24/2022
EMI Test Receiver	R&S	ESCI	101342	04/28/2021	04/27/2022
Coaxial Cable	EC Lab	RF-HY-CAB-250	RF-HY-CAB-250-01	03/27/2021	03/26/2022
Pulse Limiter	EC Lab	VTSD 9561F-N	485	03/27/2021	03/26/2022

Note: N.C.R refers to Not Calibrated Required

### 6.3 EUT Setup

- The conducted emission tests were performed in the test site, using the setup in accordance with the ANSI 63.10:2013.
- The AC/DC Power adaptor of EUT was plug-in LISN. The EUT was placed flushed with the rear of the table.
- The LISN was connected with 120Vac/60Hz power source.

Unless otherwise stated the results shown in this test report refer only to the sample(s) tested and such sample(s) are retained for 90 days only.

除非另有說明，此報告結果僅對測試之樣品負責，同時此樣品僅保留90天。本報告未經本公司書面許可，不可部份複製。

This document is issued by the Company subject to its General Conditions of Service printed overleaf, available on request or accessible at <http://www.sgs.com.tw/Terms-and-Conditions> and for electronic format documents, subject to Terms and Conditions for Electronic Documents at <http://www.sgs.com.tw/Terms-and-Conditions>. Attention is drawn to the limitation of liability, indemnification and jurisdiction issues defined therein. Any holder of this document is advised that information contained hereon reflects the Company's findings at the time of its intervention only and within the limits of Client's instructions, if any. The Company's sole responsibility is to its Client and this document does not exonerate parties to a transaction from exercising all their rights and obligations under the transaction documents. This document cannot be reproduced except in full, without prior written approval of the Company. Any unauthorized alteration, forgery or falsification of the content or appearance of this document is unlawful and offenders may be prosecuted to the fullest extent of the law.

## 6.4 Test SET-UP (Block Diagram of Configuration)

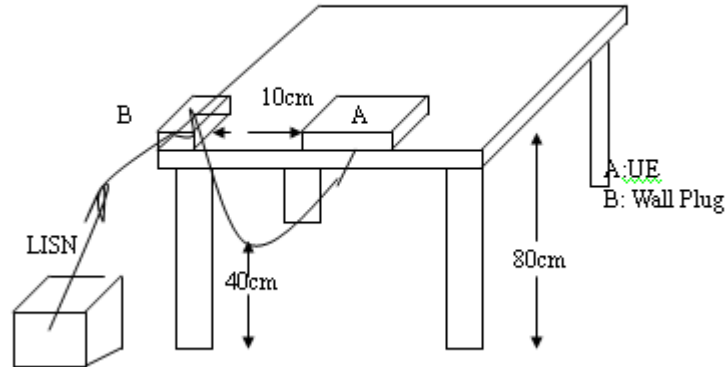

## 6.5 Measurement Procedure

1. The EUT was placed on a table which is 0.8m above ground plane.
2. Maximum procedure was performed on the six highest emissions to ensure EUT compliance.
3. Repeat above procedures until all frequency measured were complete.

## 6.6 Measurement Result

Note: Refer to next page for measurement data and plots.

Note2: The \* reveals the worst-case results that closet to the limit.

Unless otherwise stated the results shown in this test report refer only to the sample(s) tested and such sample(s) are retained for 90 days only.

除非另有說明，此報告結果僅對測試之樣品負責，同時此樣品僅保留90天。本報告未經本公司書面許可，不可部份複製。

This document is issued by the Company subject to its General Conditions of Service printed overleaf, available on request or accessible at <http://www.sgs.com.tw/Terms-and-Conditions> and for electronic format documents, subject to Terms and Conditions for Electronic Documents at <http://www.sgs.com.tw/Terms-and-Conditions>. Attention is drawn to the limitation of liability, indemnification and jurisdiction issues defined therein. Any holder of this document is advised that information contained hereon reflects the Company's findings at the time of its intervention only and within the limits of Client's instructions, if any. The Company's sole responsibility is to its Client and this document does not exonerate parties to a transaction from exercising all their rights and obligations under the transaction documents. This document cannot be reproduced except in full, without prior written approval of the Company. Any unauthorized alteration, forgery or falsification of the content or appearance of this document is unlawful and offenders may be prosecuted to the fullest extent of the law.

### AC POWER LINE CONDUCTED EMISSION TEST DATA

Report Number :E2/2021/70052      Test Site :Conduction C  
 Test Mode :BT      Test Date :2021-08-02  
 Power :120V/60Hz      Temp./Humi. :24.8/57  
 Probe :L1      Engineer :Ashton Chiu  
 Note: : Adapter:FSP05-AHCN3

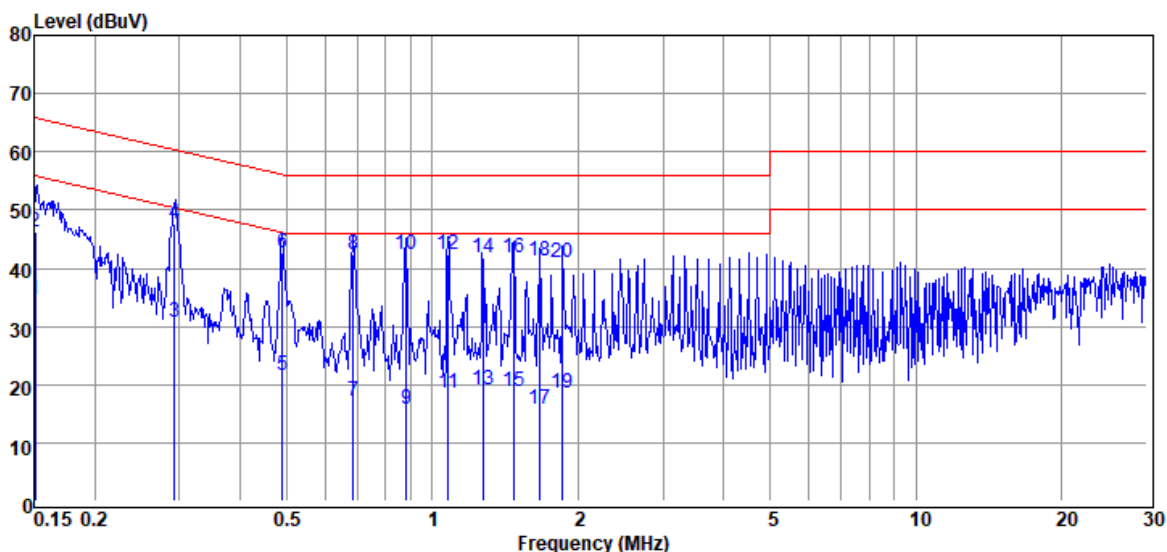

Freq. MHz	Detector Mode PK/QP/AV	Spectrum Reading Level dBμV	Factor dB	Actual FS dBμV	Limit dBμV	Margin dB
0.15	Average	24.41	10.30	34.71	55.95	-21.24
0.15	QP	35.83	10.30	46.13	65.95	-19.82
0.29	Average	20.55	10.31	30.86	50.45	-19.59
0.29	QP	37.17	10.31	47.48	60.45	-12.97
0.49	Average	11.36	10.31	21.67	46.17	-24.50
0.49	QP	32.45	10.31	42.76	56.17	-13.41
0.69	Average	6.83	10.33	17.16	46.00	-28.84
0.69	QP	32.01	10.33	42.34	56.00	-13.66
0.88	Average	5.43	10.34	15.77	46.00	-30.23
0.88	QP	32.09	10.34	42.43	56.00	-13.57
1.08	Average	8.06	10.42	18.48	46.00	-27.52
1.08	QP	31.82	10.42	42.24	56.00	-13.76
1.27	Average	8.49	10.63	19.12	46.00	-26.88
1.27	QP	31.25	10.63	41.88	56.00	-14.12
1.47	Average	7.94	10.80	18.74	46.00	-27.26

Unless otherwise stated the results shown in this test report refer only to the sample(s) tested and such sample(s) are retained for 90 days only.

除非另有說明，此報告結果僅對測試之樣品負責，同時此樣品僅保留90天。本報告未經本公司書面許可，不可部份複製。

This document is issued by the Company subject to its General Conditions of Service printed overleaf, available on request or accessible at <http://www.sgs.com.tw/Terms-and-Conditions> and for electronic format documents, subject to Terms and Conditions for Electronic Documents at <http://www.sgs.com.tw/Terms-and-Conditions>. Attention is drawn to the limitation of liability, indemnification and jurisdiction issues defined therein. Any holder of this document is advised that information contained hereon reflects the Company's findings at the time of its intervention only and within the limits of Client's instructions, if any. The Company's sole responsibility is to its Client and this document does not exonerate parties to a transaction from exercising all their rights and obligations under the transaction documents. This document cannot be reproduced except in full, without prior written approval of the Company. Any unauthorized alteration, forgery or falsification of the content or appearance of this document is unlawful and offenders may be prosecuted to the fullest extent of the law.

Report Number :E2/2021/70052      Test Site :Conduction C  
 Test Mode :BT      Test Date :2021-08-02  
 Power :120V/60Hz      Temp./Humi. :24.8/57  
 Probe :N      Engineer :Ashton Chiu  
 Note: : Adapter:FSP05-AHCN3

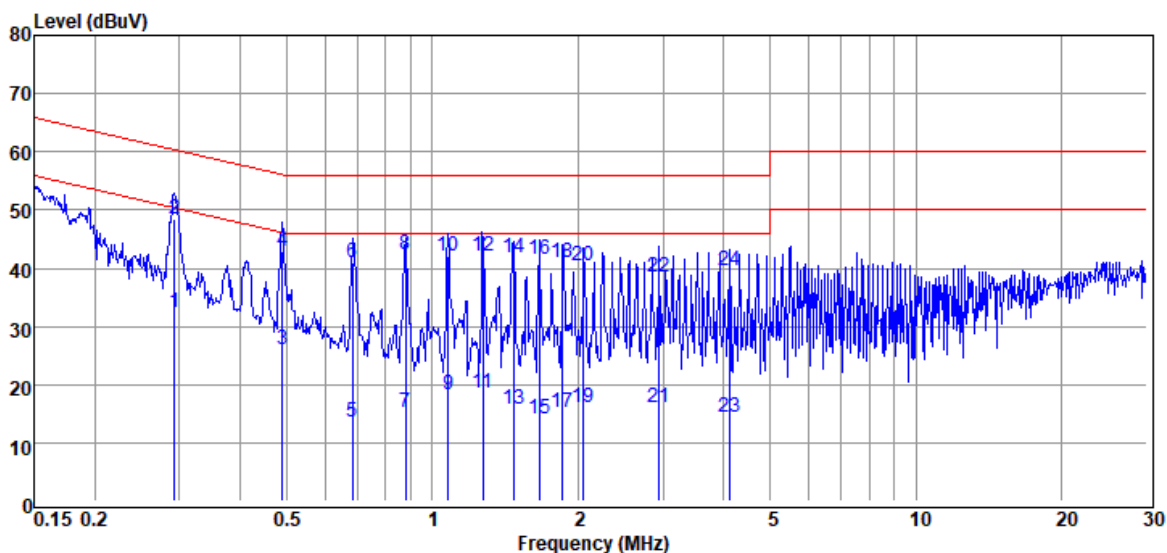

Freq. MHz	Detector Mode PK/QP/AV	Spectrum Reading Level dBμV	Factor dB	Actual FS dBμV	Limit dBμV	Margin dB
0.29	Average	22.12	10.32	32.44	50.43	-17.99
0.29	QP	38.26	10.32	48.58	60.43	-11.85
0.49	Average	15.62	10.32	25.94	46.18	-20.24
0.49	QP	32.69	10.32	43.01	56.18	-13.17
0.68	Average	3.33	10.34	13.67	46.00	-32.33
0.68	QP	30.68	10.34	41.02	56.00	-14.98
0.88	Average	4.75	10.35	15.10	46.00	-30.90
0.88	QP	31.93	10.35	42.28	56.00	-13.72
1.08	Average	7.82	10.43	18.25	46.00	-27.75
1.08	QP	31.76	10.43	42.19	56.00	-13.81
1.27	Average	7.98	10.64	18.62	46.00	-27.38
1.27	QP	31.41	10.64	42.05	56.00	-13.95
1.47	Average	4.93	10.81	15.74	46.00	-30.26
1.47	QP	31.08	10.81	41.89	56.00	-14.11
1.66	Average	3.28	10.96	14.24	46.00	-31.76

Unless otherwise stated the results shown in this test report refer only to the sample(s) tested and such sample(s) are retained for 90 days only.

除非另有說明，此報告結果僅對測試之樣品負責，同時此樣品僅保留90天。本報告未經本公司書面許可，不可部份複製。

This document is issued by the Company subject to its General Conditions of Service printed overleaf, available on request or accessible at <http://www.sgs.com.tw/Terms-and-Conditions> and for electronic format documents, subject to Terms and Conditions for Electronic Documents at <http://www.sgs.com.tw/Terms-and-Conditions>. Attention is drawn to the limitation of liability, indemnification and jurisdiction issues defined therein. Any holder of this document is advised that information contained hereon reflects the Company's findings at the time of its intervention only and within the limits of Client's instructions, if any. The Company's sole responsibility is to its Client and this document does not exonerate parties to a transaction from exercising all their rights and obligations under the transaction documents. This document cannot be reproduced except in full, without prior written approval of the Company. Any unauthorized alteration, forgery or falsification of the content or appearance of this document is unlawful and offenders may be prosecuted to the fullest extent of the law.



## 7 PEAK OUTPUT POWER MEASUREMENT

### 7.1 Standard Applicable

For frequency hopping systems operating in the 2400-2483.5 MHz band employing at least 75 hopping channels, The Limit: 1Watt. For all other frequency hopping systems in the 2400 – 2483.5MHz band: The Limit: 0.125 Watts. The power limit for 1Mbps is 1watt, and 2Mbps, 3Mbps and AFH mode are 0.125 watts.

The e.i.r.p. shall not exceed 4 W.

### 7.2 Measurement Equipment Used

Conducted Emission Test Site: Conducted D					
EQUIPMENT TYPE	MFR	MODEL NUMBER	SERIAL NUMBER	LAST CAL.	CAL DUE.
Spectrum Analyzer	KEYSIGHT	N9010B	MY59071574	06/25/2021	06/25/2022
Bluetooth Test Set	R&S	CBT	101140	05/09/2021	05/08/2022
Power Meter	Anritsu	ML2496A	1804002	04/14/2021	04/13/2022
Power Sensor	Anritsu	MA2411B	1726105	04/14/2021	04/13/2022
Power Sensor	Anritsu	MA2411B	1726106	04/14/2021	04/13/2022
Attenuator	Marvelous	WATT-218FS-10	RF16	11/19/2020	11/18/2021
DC Block	PASTERNAK	PE8210	RF158	11/19/2020	11/18/2021
Splitter	Marvelous Microwave	MVE8576	RF257	11/19/2020	11/18/2021
Coaxial Cables	Woken	00100A1F2 A196C	RF57	11/19/2020	11/18/2021
Coaxial Cables	Woken	00100A1F2 A196C	RF64	11/19/2020	11/18/2021
Test Software	SGS	Radio Test Software	V21.07.28	N/A	N/A

### 7.3 Test Set-up:

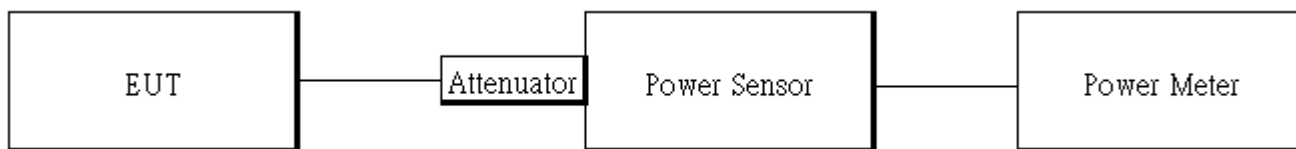

Unless otherwise stated the results shown in this test report refer only to the sample(s) tested and such sample(s) are retained for 90 days only.

除非另有說明，此報告結果僅對測試之樣品負責，同時此樣品僅保留90天。本報告未經本公司書面許可，不可部份複製。

This document is issued by the Company subject to its General Conditions of Service printed overleaf, available on request or accessible at <http://www.sgs.com.tw/Terms-and-Conditions> and for electronic format documents, subject to Terms and Conditions for Electronic Documents at <http://www.sgs.com.tw/Terms-and-Conditions>. Attention is drawn to the limitation of liability, indemnification and jurisdiction issues defined therein. Any holder of this document is advised that information contained hereon reflects the Company's findings at the time of its intervention only and within the limits of Client's instructions, if any. The Company's sole responsibility is to its Client and this document does not exonerate parties to a transaction from exercising all their rights and obligations under the transaction documents. This document cannot be reproduced except in full, without prior written approval of the Company. Any unauthorized alteration, forgery or falsification of the content or appearance of this document is unlawful and offenders may be prosecuted to the fullest extent of the law.

#### 7.4 Measurement Procedure:

1. Place the EUT on the table and set it in transmitting mode.
2. The testing follows ANSI C63.10 Measurement Guidelines.
3. Remove the antenna from the EUT and then connect a low loss RF cable from the antenna port to the power meter or spectrum. (Max Hold, Detector = Peak, RBW  $\geq$  20dB bandwidth)
4. Record the max. reading.
5. Repeat above procedures until all default test channel is completed.

Unless otherwise stated the results shown in this test report refer only to the sample(s) tested and such sample(s) are retained for 90 days only.

除非另有說明，此報告結果僅對測試之樣品負責，同時此樣品僅保留90天。本報告未經本公司書面許可，不可部份複製。

This document is issued by the Company subject to its General Conditions of Service printed overleaf, available on request or accessible at <http://www.sgs.com.tw/Terms-and-Conditions> and for electronic format documents, subject to Terms and Conditions for Electronic Documents at <http://www.sgs.com.tw/Terms-and-Conditions>. Attention is drawn to the limitation of liability, indemnification and jurisdiction issues defined therein. Any holder of this document is advised that information contained hereon reflects the Company's findings at the time of its intervention only and within the limits of Client's instructions, if any. The Company's sole responsibility is to its Client and this document does not exonerate parties to a transaction from exercising all their rights and obligations under the transaction documents. This document cannot be reproduced except in full, without prior written approval of the Company. Any unauthorized alteration, forgery or falsification of the content or appearance of this document is unlawful and offenders may be prosecuted to the fullest extent of the law.

### 7.5 Peak & Average Power Measurement Result

1M BR mode (Peak):

CH	Freq. (MHz)	Power set	Peak Output Power (dBm)	Output Power (mW)	Limit (mW)
Low	2402	default	4.37	2.735	1000
Mid	2441	default	5.36	3.436	1000
High	2480	default	<b>7.41</b>	5.508	1000

1M BR mode (Average):

CH	Freq. (MHz)	Power set	Max. Avg. Output include tune up tolerance Power (dBm)	Output Power (mW)	Limit (mW)
Low	2402	default	3.92	2.467	1000
Mid	2441	default	4.90	3.092	1000
High	2480	default	7.11	5.143	1000

2M EDR mode (Peak):

CH	Freq. (MHz)	Power set	Peak Output Power (dBm)	Output Power (mW)	Limit (mW)
Low	2402	default	<b>10.25</b>	10.593	125
Mid	2441	default	9.96	9.908	125
High	2480	default	10.06	10.139	125

2M EDR mode (Average):

CH	Freq. (MHz)	Power set	Max. Avg. Output include tune up tolerance Power (dBm)	Output Power (mW)	Limit (mW)
Low	2402	default	8.02	6.337	125
Mid	2441	default	7.80	6.024	125
High	2480	default	7.93	6.207	125

3M EDR mode (Peak):

CH	Freq. (MHz)	Power set	Peak Output Power (dBm)	Output Power (mW)	Limit (mW)
Low	2402	default	<b>10.58</b>	11.429	125
Mid	2441	default	10.25	10.593	125
High	2480	default	10.32	10.765	125

3M EDR mode (Average):

CH	Freq. (MHz)	Power set	Max. Avg. Output include tune up tolerance Power (dBm)	Output Power (mW)	Limit (mW)
Low	2402	default	8.09	6.443	125
Mid	2441	default	7.85	6.097	125
High	2480	default	7.96	6.253	125

NOTE: cable loss as 14.1dB that offsets in the spectrum

\*Note: Max. Output include tune up tolerance Power measured by using average detector.

Unless otherwise stated the results shown in this test report refer only to the sample(s) tested and such sample(s) are retained for 90 days only.

除非另有說明，此報告結果僅對測試之樣品負責，同時此樣品僅保留90天。本報告未經本公司書面許可，不可部份複製。

This document is issued by the Company subject to its General Conditions of Service printed overleaf, available on request or accessible at <http://www.sgs.com.tw/Terms-and-Conditions> and for electronic format documents, subject to Terms and Conditions for Electronic Documents at <http://www.sgs.com.tw/Terms-and-Conditions>. Attention is drawn to the limitation of liability, indemnification and jurisdiction issues defined therein. Any holder of this document is advised that information contained hereon reflects the Company's findings at the time of its intervention only and within the limits of Client's instructions, if any. The Company's sole responsibility is to its Client and this document does not exonerate parties to a transaction from exercising all their rights and obligations under the transaction documents. This document cannot be reproduced except in full, without prior written approval of the Company. Any unauthorized alteration, forgery or falsification of the content or appearance of this document is unlawful and offenders may be prosecuted to the fullest extent of the law.

**7.6 EIRP Measurement Result**

1M BR mode EIRP

Channel	Frequency (MHz)	Power set	Max. Avg. Output include tune up tolerance Power (dBm)	Antenna Gain (dBi)	EIRP (mW)	Limit (mW)
Low	2402	default	3.92	1.58	3.550	4000
Mid	2441	default	4.90	1.58	4.448	4000
High	2480	default	7.11	1.58	7.399	4000

2M EDR mode EIRP

Channel	Frequency (MHz)	Power set	Max. Avg. Output include tune up tolerance Power (dBm)	Antenna Gain (dBi)	EIRP (mW)	Limit (mW)
Low	2402	default	8.02	1.58	9.117	4000
Mid	2441	default	7.80	1.58	8.667	4000
High	2480	default	7.93	1.58	8.930	4000

3M EDR mode EIRP

Channel	Frequency (MHz)	Power set	Max. Avg. Output include tune up tolerance Power (dBm)	Antenna Gain (dBi)	EIRP (mW)	Limit (mW)
Low	2402	default	8.09	1.58	9.271	4000
Mid	2441	default	7.85	1.58	8.772	4000
High	2480	default	7.96	1.58	8.997	4000

\* **Note:** EIRP = Average Power + Gain

Unless otherwise stated the results shown in this test report refer only to the sample(s) tested and such sample(s) are retained for 90 days only.

除非另有說明，此報告結果僅對測試之樣品負責，同時此樣品僅保留90天。本報告未經本公司書面許可，不可部份複製。

This document is issued by the Company subject to its General Conditions of Service printed overleaf, available on request or accessible at <http://www.sgs.com.tw/Terms-and-Conditions> and for electronic format documents, subject to Terms and Conditions for Electronic Documents at <http://www.sgs.com.tw/Terms-and-Conditions>. Attention is drawn to the limitation of liability, indemnification and jurisdiction issues defined therein. Any holder of this document is advised that information contained hereon reflects the Company's findings at the time of its intervention only and within the limits of Client's instructions, if any. The Company's sole responsibility is to its Client and this document does not exonerate parties to a transaction from exercising all their rights and obligations under the transaction documents. This document cannot be reproduced except in full, without prior written approval of the Company. Any unauthorized alteration, forgery or falsification of the content or appearance of this document is unlawful and offenders may be prosecuted to the fullest extent of the law.

## 8 EMISSION BANDWIDTH MEASUREMENT

### 8.1 Standard Applicable

For frequency hopping systems operating in the 2400 MHz-2483.5 MHz no limit for 20dB bandwidth.

### 8.2 Measurement Equipment Used

Conducted Emission Test Site: Conducted D					
EQUIPMENT TYPE	MFR	MODEL NUMBER	SERIAL NUMBER	LAST CAL.	CAL DUE.
Spectrum Analyzer	KEYSIGHT	N9010B	MY59071574	06/25/2021	06/25/2022
Bluetooth Test Set	R&S	CBT	101140	05/09/2021	05/08/2022
Power Meter	Anritsu	ML2496A	1804002	04/14/2021	04/13/2022
Power Sensor	Anritsu	MA2411B	1726105	04/14/2021	04/13/2022
Power Sensor	Anritsu	MA2411B	1726106	04/14/2021	04/13/2022
Attenuator	Marvelous	WATT-218FS-10	RF16	11/19/2020	11/18/2021
DC Block	PASTERNAK	PE8210	RF158	11/19/2020	11/18/2021
Splitter	Marvelous Microwave	MVE8576	RF257	11/19/2020	11/18/2021
Coaxial Cables	Woken	00100A1F2 A196C	RF57	11/19/2020	11/18/2021
Coaxial Cables	Woken	00100A1F2 A196C	RF64	11/19/2020	11/18/2021
Test Software	SGS	Radio Test Software	V21.07.28	N/A	N/A

### 8.3 Test Set-up

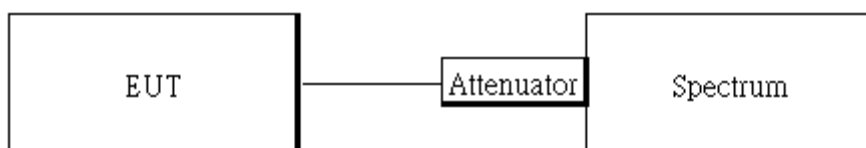

### 8.4 Measurement Procedure

1. Place the EUT on the table and set it in transmitting mode.
2. The testing follows ANSI C63.10:2013.
3. Remove the antenna from the EUT and then connect a low loss RF cable from the antenna port to the spectrum analyzer.
4. Set the spectrum analyzer as  
 RBW= 1 % to 5% of OBW ,  
 VBW = 3 X RBW,

Unless otherwise stated the results shown in this test report refer only to the sample(s) tested and such sample(s) are retained for 90 days only.

除非另有說明，此報告結果僅對測試之樣品負責，同時此樣品僅保留90天。本報告未經本公司書面許可，不可部份複製。

This document is issued by the Company subject to its General Conditions of Service printed overleaf, available on request or accessible at <http://www.sgs.com.tw/Terms-and-Conditions> and for electronic format documents, subject to Terms and Conditions for Electronic Documents at <http://www.sgs.com.tw/Terms-and-Conditions>. Attention is drawn to the limitation of liability, indemnification and jurisdiction issues defined therein. Any holder of this document is advised that information contained hereon reflects the Company's findings at the time of its intervention only and within the limits of Client's instructions, if any. The Company's sole responsibility is to its Client and this document does not exonerate parties to a transaction from exercising all their rights and obligations under the transaction documents. This document cannot be reproduced except in full, without prior written approval of the Company. Any unauthorized alteration, forgery or falsification of the content or appearance of this document is unlawful and offenders may be prosecuted to the fullest extent of the law.

- Span= 2 to 5 times of the OBW,  
Sweep=auto,  
Detector = Peak, and Max hold for 20dB Bandwidth test.
5. Mark the peak frequency and -20dB (upper and lower) frequency
  6. Set the spectrum analyzer as  
RBW= 1 % to 5% of 99% Bandwidth ,  
VBW  $\geq$  3 X RBW,  
Span= large enough to capture all products of the modulation process,  
Sweep=auto,  
Detector = Peak, and Max hold for 99% Bandwidth test.
  7. Mark the peak frequency and 99%dB (upper and lower) frequency
  8. Repeat above procedures until all test default channel is completed

Unless otherwise stated the results shown in this test report refer only to the sample(s) tested and such sample(s) are retained for 90 days only.

除非另有說明，此報告結果僅對測試之樣品負責，同時此樣品僅保留90天。本報告未經本公司書面許可，不可部份複製。

This document is issued by the Company subject to its General Conditions of Service printed overleaf, available on request or accessible at <http://www.sgs.com.tw/Terms-and-Conditions> and for electronic format documents, subject to Terms and Conditions for Electronic Documents at <http://www.sgs.com.tw/Terms-and-Conditions>. Attention is drawn to the limitation of liability, indemnification and jurisdiction issues defined therein. Any holder of this document is advised that information contained hereon reflects the Company's findings at the time of its intervention only and within the limits of Client's instructions, if any. The Company's sole responsibility is to its Client and this document does not exonerate parties to a transaction from exercising all their rights and obligations under the transaction documents. This document cannot be reproduced except in full, without prior written approval of the Company. Any unauthorized alteration, forgery or falsification of the content or appearance of this document is unlawful and offenders may be prosecuted to the fullest extent of the law.

## 8.5 20dB Bandwidth

### GFSK

CH	20 dB BW (MHz)	2/3 BW (MHz)
Low	0.9912	0.66
Mid	0.9932	0.66
High	0.993	0.66

### $\pi/4$ -DQPSK

CH	20 dB BW (MHz)	2/3 BW (MHz)
Low	1.338	0.89
Mid	1.349	0.90
High	1.350	0.90

### 8-DPSK

CH	20 dB BW (MHz)	2/3 BW (MHz)
Low	1.328	0.89
Mid	1.330	0.89
High	1.333	0.89

Unless otherwise stated the results shown in this test report refer only to the sample(s) tested and such sample(s) are retained for 90 days only.

除非另有說明，此報告結果僅對測試之樣品負責，同時此樣品僅保留90天。本報告未經本公司書面許可，不可部份複製。

This document is issued by the Company subject to its General Conditions of Service printed overleaf, available on request or accessible at <http://www.sgs.com.tw/Terms-and-Conditions> and for electronic format documents, subject to Terms and Conditions for Electronic Documents at <http://www.sgs.com.tw/Terms-and-Conditions>. Attention is drawn to the limitation of liability, indemnification and jurisdiction issues defined therein. Any holder of this document is advised that information contained hereon reflects the Company's findings at the time of its intervention only and within the limits of Client's instructions, if any. The Company's sole responsibility is to its Client and this document does not exonerate parties to a transaction from exercising all their rights and obligations under the transaction documents. This document cannot be reproduced except in full, without prior written approval of the Company. Any unauthorized alteration, forgery or falsification of the content or appearance of this document is unlawful and offenders may be prosecuted to the fullest extent of the law.

8.6 99% Bandwidth

**GFSK**

CH	99% BW (MHz)
Low	0.88914
Mid	0.8893
High	0.88764

**$\pi/4$ -DQPSK**

CH	99% BW (MHz)
Low	1.1889
Mid	1.1964
High	1.1992

**8-DPSK**

CH	99% BW (MHz)
Low	1.2016
Mid	1.2084
High	1.2110

Unless otherwise stated the results shown in this test report refer only to the sample(s) tested and such sample(s) are retained for 90 days only.

除非另有說明，此報告結果僅對測試之樣品負責，同時此樣品僅保留90天。本報告未經本公司書面許可，不可部份複製。

This document is issued by the Company subject to its General Conditions of Service printed overleaf, available on request or accessible at <http://www.sgs.com.tw/Terms-and-Conditions> and for electronic format documents, subject to Terms and Conditions for Electronic Documents at <http://www.sgs.com.tw/Terms-and-Conditions>. Attention is drawn to the limitation of liability, indemnification and jurisdiction issues defined therein. Any holder of this document is advised that information contained hereon reflects the Company's findings at the time of its intervention only and within the limits of Client's instructions, if any. The Company's sole responsibility is to its Client and this document does not exonerate parties to a transaction from exercising all their rights and obligations under the transaction documents. This document cannot be reproduced except in full, without prior written approval of the Company. Any unauthorized alteration, forgery or falsification of the content or appearance of this document is unlawful and offenders may be prosecuted to the fullest extent of the law.



OBW 20dB\_GFSK\_1M\_DH5\_2402MHz



OBW 20dB\_π/4DQPSK\_2M\_DH5\_2402MHz

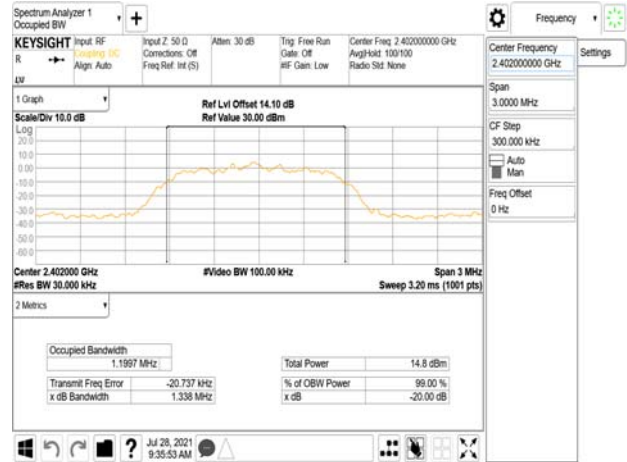

OBW 20dB\_GFSK\_1M\_DH5\_2441MHz



OBW 20dB\_π/4DQPSK\_2M\_DH5\_2441MHz

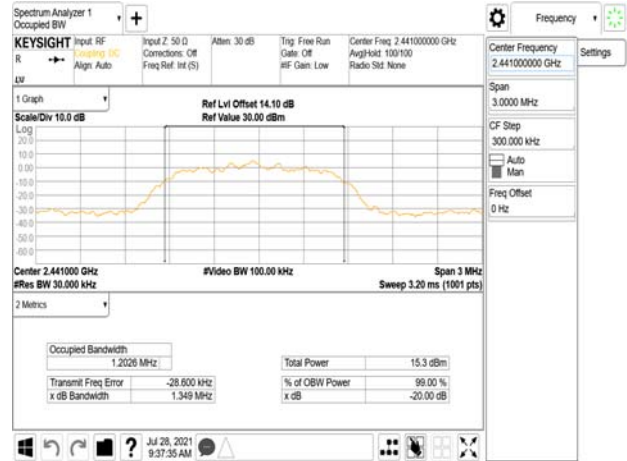

OBW 20dB\_GFSK\_1M\_DH5\_2480MHz



OBW 20dB\_π/4DQPSK\_2M\_DH5\_2480MHz

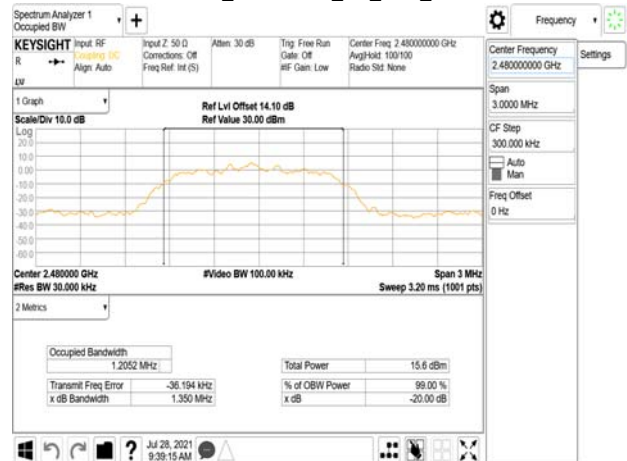

Unless otherwise stated the results shown in this test report refer only to the sample(s) tested and such sample(s) are retained for 90 days only.

除非另有說明，此報告結果僅對測試之樣品負責，同時此樣品僅保留90天。本報告未經本公司書面許可，不可部份複製。

This document is issued by the Company subject to its General Conditions of Service printed overleaf, available on request or accessible at <http://www.sgs.com.tw/Terms-and-Conditions> and for electronic format documents, subject to Terms and Conditions for Electronic Documents at <http://www.sgs.com.tw/Terms-and-Conditions>. Attention is drawn to the limitation of liability, indemnification and jurisdiction issues defined therein. Any holder of this document is advised that information contained herein reflects the Company's findings at the time of its intervention only and within the limits of Client's instructions, if any. The Company's sole responsibility is to its Client and this document does not exonerate parties to a transaction from exercising all their rights and obligations under the transaction documents. This document cannot be reproduced except in full, without prior written approval of the Company. Any unauthorized alteration, forgery or falsification of the content or appearance of this document is unlawful and offenders may be prosecuted to the fullest extent of the law.

OBW 20dB\_8DPSK\_3M\_DH5\_2402MHz

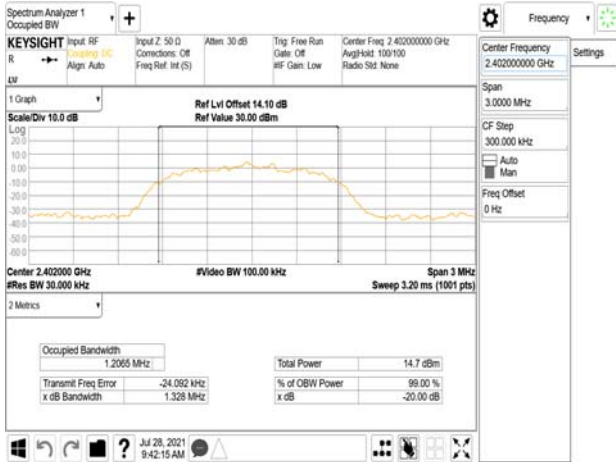

IC OBW 99%\_GFSK\_1M\_DH5\_2402MHz

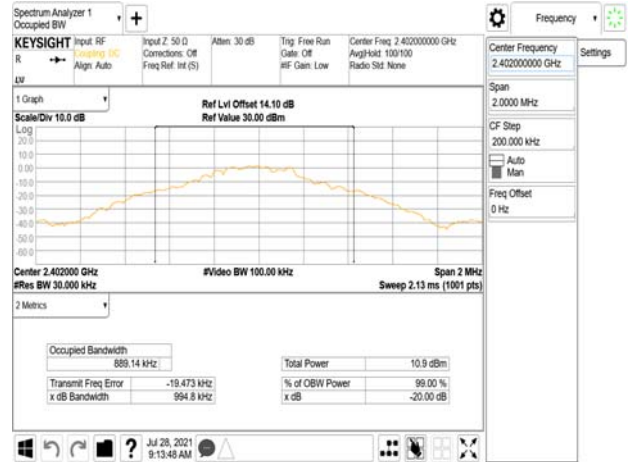

OBW 20dB\_8DPSK\_3M\_DH5\_2441MHz

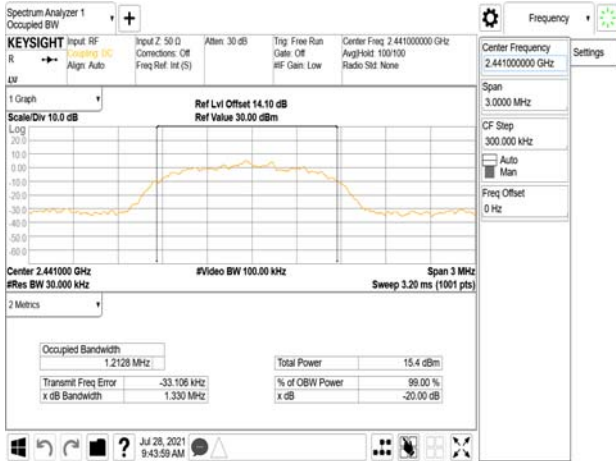

IC OBW 99%\_GFSK\_1M\_DH5\_2441MHz

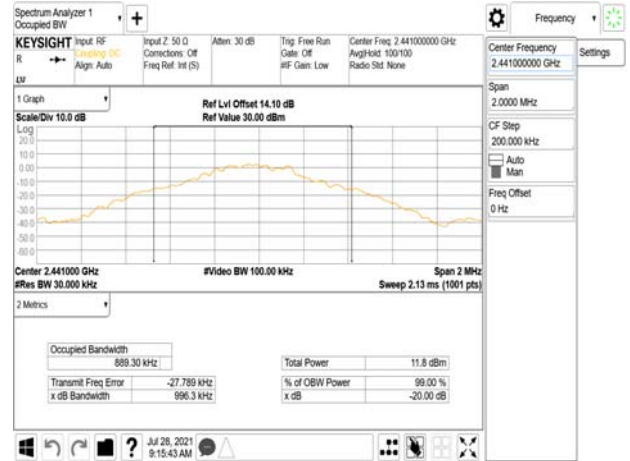

OBW 20dB\_8DPSK\_3M\_DH5\_2480MHz



IC OBW 99%\_GFSK\_1M\_DH5\_2480MHz



Unless otherwise stated the results shown in this test report refer only to the sample(s) tested and such sample(s) are retained for 90 days only.

除非另有說明，此報告結果僅對測試之樣品負責，同時此樣品僅保留90天。本報告未經本公司書面許可，不可部份複製。

This document is issued by the Company subject to its General Conditions of Service printed overleaf, available on request or accessible at <http://www.sgs.com.tw/Terms-and-Conditions> and for electronic format documents, subject to Terms and Conditions for Electronic Documents at <http://www.sgs.com.tw/Terms-and-Conditions>. Attention is drawn to the limitation of liability, indemnification and jurisdiction issues defined therein. Any holder of this document is advised that information contained hereon reflects the Company's findings at the time of its intervention only and within the limits of Client's instructions, if any. The Company's sole responsibility is to its Client and this document does not exonerate parties to a transaction from exercising all their rights and obligations under the transaction documents. This document cannot be reproduced except in full, without prior written approval of the Company. Any unauthorized alteration, forgery or falsification of the content or appearance of this document is unlawful and offenders may be prosecuted to the fullest extent of the law.

IC OBW 99%\_π/4DQPSK\_2M\_DH5\_2402MHz

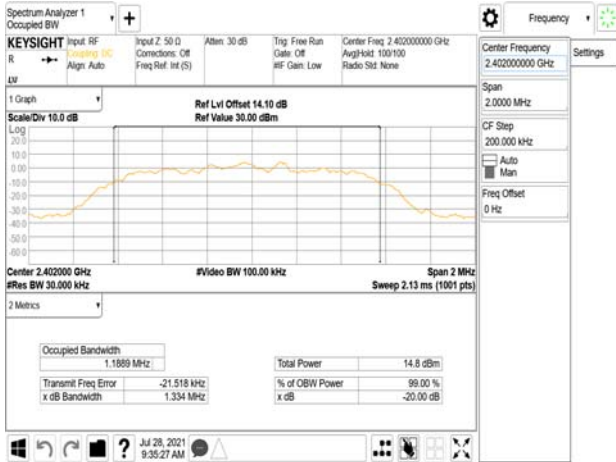

IC OBW 99%\_8DPSK\_3M\_DH5\_2402MHz

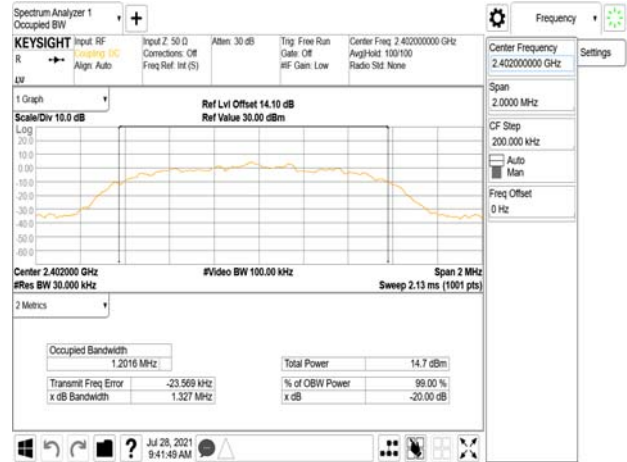

IC OBW 99%\_π/4DQPSK\_2M\_DH5\_2441MHz

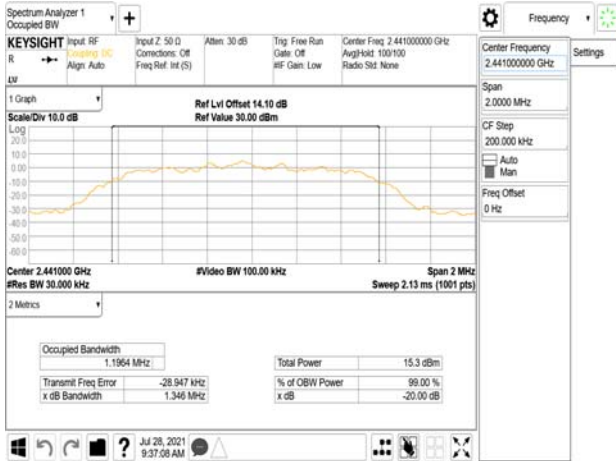

IC OBW 99%\_8DPSK\_3M\_DH5\_2441MHz

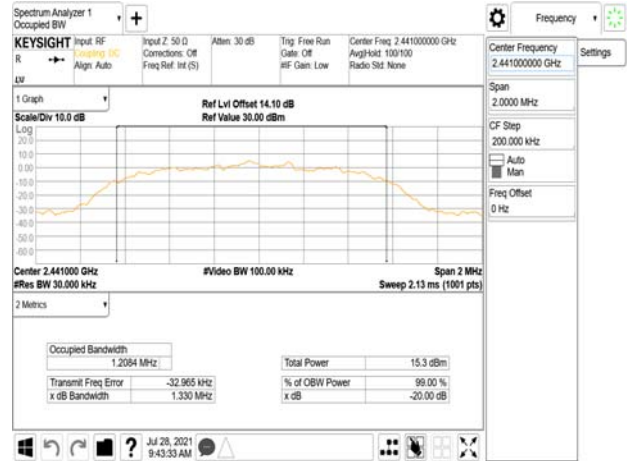

IC OBW 99%\_π/4DQPSK\_2M\_DH5\_2480MHz

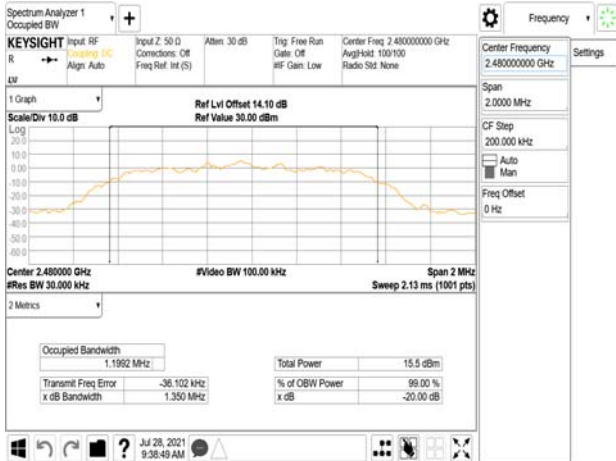

IC OBW 99%\_8DPSK\_3M\_DH5\_2480MHz

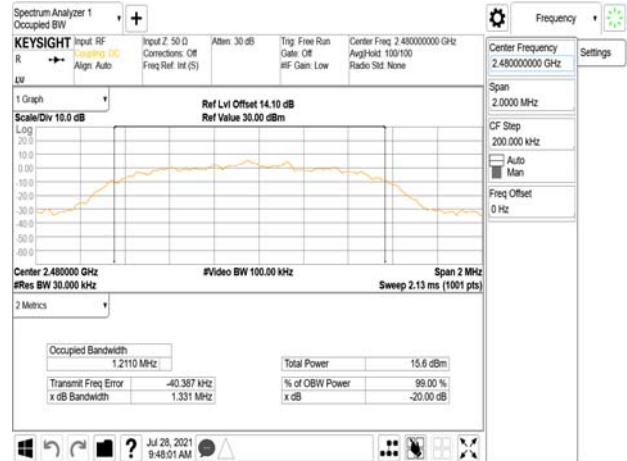

Unless otherwise stated the results shown in this test report refer only to the sample(s) tested and such sample(s) are retained for 90 days only.

除非另有說明，此報告結果僅對測試之樣品負責，同時此樣品僅保留90天。本報告未經本公司書面許可，不可部份複製。

This document is issued by the Company subject to its General Conditions of Service printed overleaf, available on request or accessible at <http://www.sgs.com.tw/Terms-and-Conditions> and for electronic format documents, subject to Terms and Conditions for Electronic Documents at <http://www.sgs.com.tw/Terms-and-Conditions>. Attention is drawn to the limitation of liability, indemnification and jurisdiction issues defined therein. Any holder of this document is advised that information contained herein reflects the Company's findings at the time of its intervention only and within the limits of Client's instructions, if any. The Company's sole responsibility is to its Client and this document does not exonerate parties to a transaction from exercising all their rights and obligations under the transaction documents. This document cannot be reproduced except in full, without prior written approval of the Company. Any unauthorized alteration, forgery or falsification of the content or appearance of this document is unlawful and offenders may be prosecuted to the fullest extent of the law.

## 9 CONDUCTED BAND EDGES AND SPURIOUS EMISSION MEASUREMENT

### 9.1 Standard Applicable

In any 100 kHz bandwidth outside the frequency band in which the spread spectrum or digitally modulated intentional radiator is operating, the radio frequency power that is produced by the intentional radiator shall be at least 20 dB below that in the 100 kHz bandwidth within the band that contains the highest level of the desired power, based on either an RF conducted or a radiated measurement, provided the transmitter demonstrates compliance with the peak conducted power limits. In addition, radiated emissions which fall in the restricted bands, as defined in §15.205(a) & RSS-Gen §8.10, must also comply with the radiated emission limits specified in §15.209(a) & RSS-Gen §8.9.

### 9.2 Measurement Equipment Used

Conducted Emission Test Site: Conducted D					
EQUIPMENT TYPE	MFR	MODEL NUMBER	SERIAL NUMBER	LAST CAL.	CAL DUE.
Spectrum Analyzer	KEYSIGHT	N9010B	MY59071574	06/25/2021	06/25/2022
Bluetooth Test Set	R&S	CBT	101140	05/09/2021	05/08/2022
Power Meter	Anritsu	ML2496A	1804002	04/14/2021	04/13/2022
Power Sensor	Anritsu	MA2411B	1726105	04/14/2021	04/13/2022
Power Sensor	Anritsu	MA2411B	1726106	04/14/2021	04/13/2022
Attenuator	Marvelous	WATT-218FS-10	RF16	11/19/2020	11/18/2021
DC Block	PASTERNAK	PE8210	RF158	11/19/2020	11/18/2021
Splitter	Marvelous Microwave	MVE8576	RF257	11/19/2020	11/18/2021
Coaxial Cables	Woken	00100A1F2 A196C	RF57	11/19/2020	11/18/2021
Coaxial Cables	Woken	00100A1F2 A196C	RF64	11/19/2020	11/18/2021
Test Software	SGS	Radio Test Software	V21.07.28	N/A	N/A

### 9.3 Test SET-UP

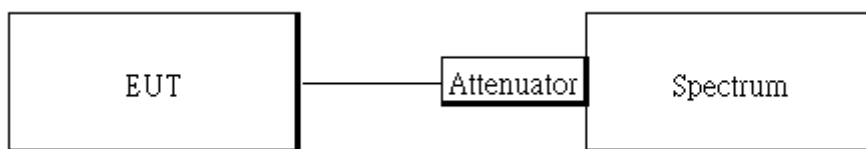

Unless otherwise stated the results shown in this test report refer only to the sample(s) tested and such sample(s) are retained for 90 days only.

除非另有說明，此報告結果僅對測試之樣品負責，同時此樣品僅保留90天。本報告未經本公司書面許可，不可部份複製。

This document is issued by the Company subject to its General Conditions of Service printed overleaf, available on request or accessible at <http://www.sgs.com.tw/Terms-and-Conditions> and for electronic format documents, subject to Terms and Conditions for Electronic Documents at <http://www.sgs.com.tw/Terms-and-Conditions>. Attention is drawn to the limitation of liability, indemnification and jurisdiction issues defined therein. Any holder of this document is advised that information contained hereon reflects the Company's findings at the time of its intervention only and within the limits of Client's instructions, if any. The Company's sole responsibility is to its Client and this document does not exonerate parties to a transaction from exercising all their rights and obligations under the transaction documents. This document cannot be reproduced except in full, without prior written approval of the Company. Any unauthorized alteration, forgery or falsification of the content or appearance of this document is unlawful and offenders may be prosecuted to the fullest extent of the law.

## 9.4 Measurement Procedure

### 9.4.1 Conducted Band Edge:

1. Place the EUT on the table and set it in transmitting mode.
2. The testing follows ANSI C63.10:2013.
3. Remove the antenna from the EUT and then connect a low loss RF cable from the antenna port to the spectrum analyzer.
4. Set center frequency of spectrum analyzer = operating frequency.
5. Set the spectrum analyzer as RBW=100 kHz, VBW=300 kHz, Sweep = auto
6. Mark Peak, 2.3999GHz and 2.4836GHz and record the max. level.
7. Repeat above procedures until all frequency measured were complete.

### 9.4.2 Conducted Spurious Emission:

1. To connect Antenna Port of EUT to Spectrum.
2. The testing follows ANSI C63.10:2013.
3. Set RBW = 100 kHz & VBW = 300 kHz, Detector =Peak, Sweep = Auto
4. Allow trace to fully stabilize.
5. Use the peak marker function to determine the maximum power level in any 100 kHz band segment within the fundamental EBW.
6. Repeat above procedures until all default test channel measured were complete.

## 9.5 Measurement Result

See next page for test plots.

Unless otherwise stated the results shown in this test report refer only to the sample(s) tested and such sample(s) are retained for 90 days only.

除非另有說明，此報告結果僅對測試之樣品負責，同時此樣品僅保留90天。本報告未經本公司書面許可，不可部份複製。

This document is issued by the Company subject to its General Conditions of Service printed overleaf, available on request or accessible at <http://www.sgs.com.tw/Terms-and-Conditions> and for electronic format documents, subject to Terms and Conditions for Electronic Documents at <http://www.sgs.com.tw/Terms-and-Conditions>. Attention is drawn to the limitation of liability, indemnification and jurisdiction issues defined therein. Any holder of this document is advised that information contained hereon reflects the Company's findings at the time of its intervention only and within the limits of Client's instructions, if any. The Company's sole responsibility is to its Client and this document does not exonerate parties to a transaction from exercising all their rights and obligations under the transaction documents. This document cannot be reproduced except in full, without prior written approval of the Company. Any unauthorized alteration, forgery or falsification of the content or appearance of this document is unlawful and offenders may be prosecuted to the fullest extent of the law.



Band Edge\_GFSK\_1M\_DH5\_2402MHz

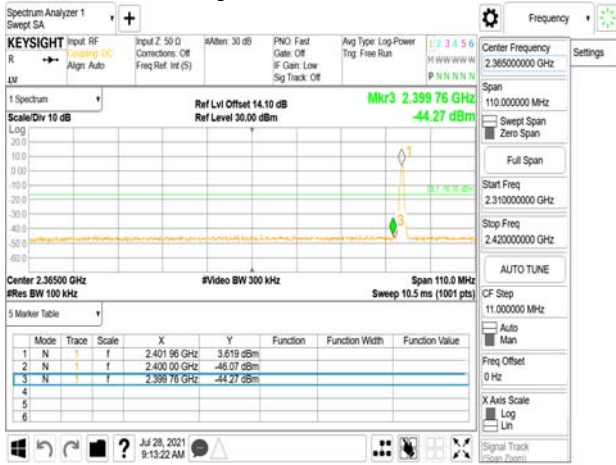

Band Edge\_8DPSK\_3M\_DH5\_2402MHz

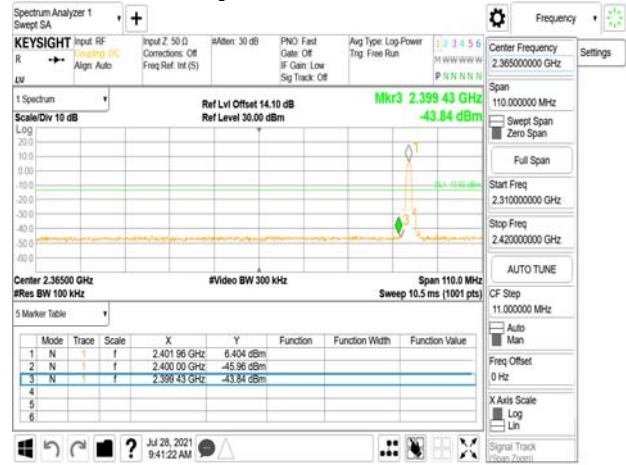

Band Edge\_GFSK\_1M\_DH5\_2480MHz

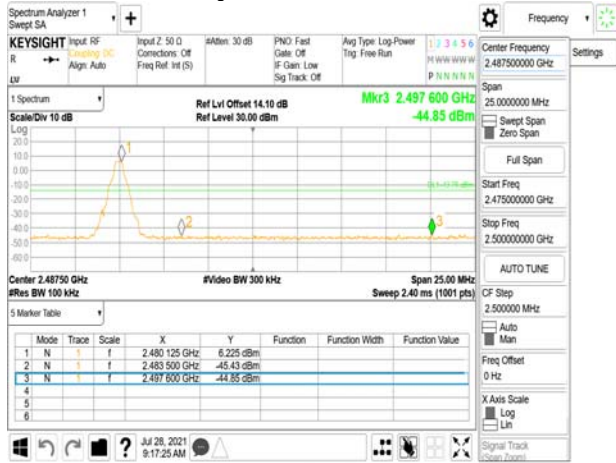

Band Edge\_8DPSK\_3M\_DH5\_2480MHz



Unless otherwise stated the results shown in this test report refer only to the sample(s) tested and such sample(s) are retained for 90 days only.

除非另有說明，此報告結果僅對測試之樣品負責，同時此樣品僅保留90天。本報告未經本公司書面許可，不可部份複製。

This document is issued by the Company subject to its General Conditions of Service printed overleaf, available on request or accessible at <http://www.sgs.com.tw/Terms-and-Conditions> and for electronic format documents, subject to Terms and Conditions for Electronic Documents at <http://www.sgs.com.tw/Terms-and-Conditions>. Attention is drawn to the limitation of liability, indemnification and jurisdiction issues defined therein. Any holder of this document is advised that information contained hereon reflects the Company's findings at the time of its intervention only and within the limits of Client's instructions, if any. The Company's sole responsibility is to its Client and this document does not exonerate parties to a transaction from exercising all their rights and obligations under the transaction documents. This document cannot be reproduced except in full, without prior written approval of the Company. Any unauthorized alteration, forgery or falsification of the content or appearance of this document is unlawful and offenders may be prosecuted to the fullest extent of the law.

Hopping Band Edge\_GFSK\_1M\_DH5\_2402MHz



Hopping Band Edge\_8DPSK\_3M\_DH5\_2402MHz



Hopping Band Edge\_GFSK\_1M\_DH5\_2480MHz

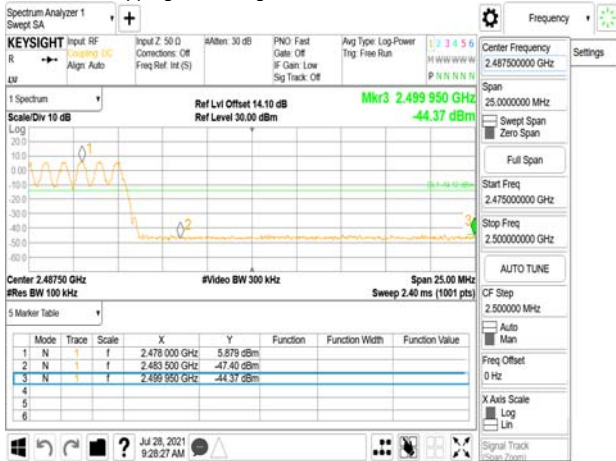

Hopping Band Edge\_8DPSK\_3M\_DH5\_2480MHz

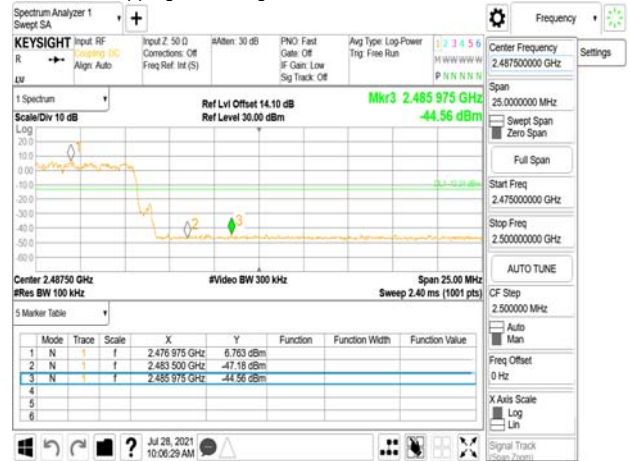

Unless otherwise stated the results shown in this test report refer only to the sample(s) tested and such sample(s) are retained for 90 days only.

除非另有說明，此報告結果僅對測試之樣品負責，同時此樣品僅保留90天。本報告未經本公司書面許可，不可部份複製。

This document is issued by the Company subject to its General Conditions of Service printed overleaf, available on request or accessible at <http://www.sgs.com.tw/Terms-and-Conditions> and for electronic format documents, subject to Terms and Conditions for Electronic Documents at <http://www.sgs.com.tw/Terms-and-Conditions>. Attention is drawn to the limitation of liability, indemnification and jurisdiction issues defined therein. Any holder of this document is advised that information contained hereon reflects the Company's findings at the time of its intervention only and within the limits of Client's instructions, if any. The Company's sole responsibility is to its Client and this document does not exonerate parties to a transaction from exercising all their rights and obligations under the transaction documents. This document cannot be reproduced except in full, without prior written approval of the Company. Any unauthorized alteration, forgery or falsification of the content or appearance of this document is unlawful and offenders may be prosecuted to the fullest extent of the law.

Spurious Emission\_GFSK\_1M\_DH5\_2402MHz



Spurious Emission\_π/4DQPSK\_2M\_DH5\_2402MHz



Spurious Emission\_GFSK\_1M\_DH5\_2441MHz



Spurious Emission\_π/4DQPSK\_2M\_DH5\_2441MHz



Spurious Emission\_GFSK\_1M\_DH5\_2480MHz

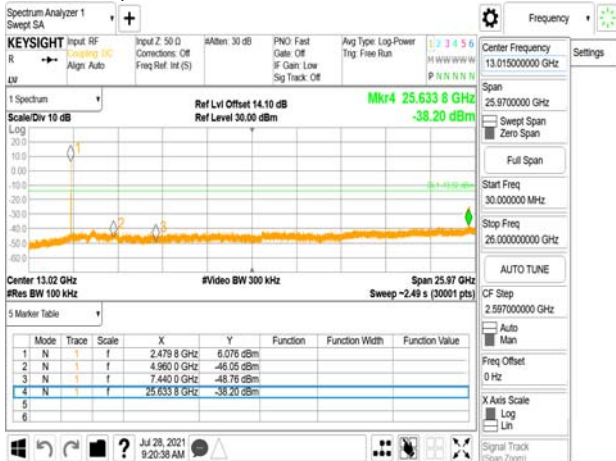

Spurious Emission\_π/4DQPSK\_2M\_DH5\_2480MHz



Unless otherwise stated the results shown in this test report refer only to the sample(s) tested and such sample(s) are retained for 90 days only.

除非另有說明，此報告結果僅對測試之樣品負責，同時此樣品僅保留90天。本報告未經本公司書面許可，不可部份複製。

This document is issued by the Company subject to its General Conditions of Service printed overleaf, available on request or accessible at <http://www.sgs.com.tw/Terms-and-Conditions> and for electronic format documents, subject to Terms and Conditions for Electronic Documents at <http://www.sgs.com.tw/Terms-and-Conditions>. Attention is drawn to the limitation of liability, indemnification and jurisdiction issues defined therein. Any holder of this document is advised that information contained hereon reflects the Company's findings at the time of its intervention only and within the limits of Client's instructions, if any. The Company's sole responsibility is to its Client and this document does not exonerate parties to a transaction from exercising all their rights and obligations under the transaction documents. This document cannot be reproduced except in full, without prior written approval of the Company. Any unauthorized alteration, forgery or falsification of the content or appearance of this document is unlawful and offenders may be prosecuted to the fullest extent of the law.



Spurious Emission\_8DPSK\_3M\_DH5\_2402MHz



Spurious Emission\_8DPSK\_3M\_DH5\_2441MHz



Spurious Emission\_8DPSK\_3M\_DH5\_2480MHz

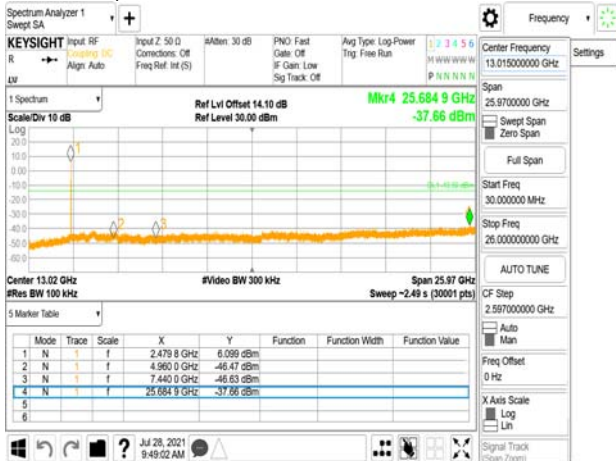

Unless otherwise stated the results shown in this test report refer only to the sample(s) tested and such sample(s) are retained for 90 days only.

除非另有說明，此報告結果僅對測試之樣品負責，同時此樣品僅保留90天。本報告未經本公司書面許可，不可部份複製。

This document is issued by the Company subject to its General Conditions of Service printed overleaf, available on request or accessible at <http://www.sgs.com.tw/Terms-and-Conditions> and for electronic format documents, subject to Terms and Conditions for Electronic Documents at <http://www.sgs.com.tw/Terms-and-Conditions>. Attention is drawn to the limitation of liability, indemnification and jurisdiction issues defined therein. Any holder of this document is advised that information contained hereon reflects the Company's findings at the time of its intervention only and within the limits of Client's instructions, if any. The Company's sole responsibility is to its Client and this document does not exonerate parties to a transaction from exercising all their rights and obligations under the transaction documents. This document cannot be reproduced except in full, without prior written approval of the Company. Any unauthorized alteration, forgery or falsification of the content or appearance of this document is unlawful and offenders may be prosecuted to the fullest extent of the law.

## 10 RADIATED BANDEDGE AND SPURIOUS EMISSION MEASUREMENT

### 10.1 Standard Applicable

In any 100 kHz bandwidth outside the frequency band in which the spread spectrum or digitally modulated intentional radiator is operating, the radio frequency power that is produced by the intentional radiator shall be at least 20 dB below that in the 100 kHz bandwidth within the band that contains the highest level of the desired power, based on either an RF conducted or a radiated measurement, provided the transmitter demonstrates compliance with the peak conducted power limits. In addition, radiated emissions which fall in the restricted bands must also comply with the §15.209 and RSS-Gen §8.9 Table 5 and 6 limit as below.

And according to §15.33(a) (1) & RSS-Gen §6.13.2.a, for an intentional radiator operates below 10GHz, the frequency range of measurements: to the tenth harmonic of the highest fundamental frequency or to 40GHz, whichever is lower.

Frequency (MHz)	Field strength (microvolts/meter)	Distance (meters)
0.009-0.490	2400/F(kHz)	300
0.490-1.705	24000/F(kHz)	30
1.705-30	30	30
30-88	100	3
88-216	150	3
216-960	200	3
Above 960	500	3

**Note:**

1. The lower limit shall apply at the transition frequencies.

Unless otherwise stated the results shown in this test report refer only to the sample(s) tested and such sample(s) are retained for 90 days only.

除非另有說明，此報告結果僅對測試之樣品負責，同時此樣品僅保留90天。本報告未經本公司書面許可，不可部份複製。

This document is issued by the Company subject to its General Conditions of Service printed overleaf, available on request or accessible at <http://www.sgs.com.tw/Terms-and-Conditions> and for electronic format documents, subject to Terms and Conditions for Electronic Documents at <http://www.sgs.com.tw/Terms-and-Conditions>. Attention is drawn to the limitation of liability, indemnification and jurisdiction issues defined therein. Any holder of this document is advised that information contained hereon reflects the Company's findings at the time of its intervention only and within the limits of Client's instructions, if any. The Company's sole responsibility is to its Client and this document does not exonerate parties to a transaction from exercising all their rights and obligations under the transaction documents. This document cannot be reproduced except in full, without prior written approval of the Company. Any unauthorized alteration, forgery or falsification of the content or appearance of this document is unlawful and offenders may be prosecuted to the fullest extent of the law.

10.2 Measurement Equipment Used

Radiated Emission Test Site: SAC C					
EQUIPMENT TYPE	MFR	MODEL NUMBER	SERIAL NUMBER	LAST CAL.	CAL DUE.
Broadband Antenna	TESEQ	CBL 6112D	35240	09/08/2020	09/07/2021
Horn Antenna	Schwarzbeck	BBHA9170	184	12/11/2020	12/10/2021
Horn Antenna	Schwarzbeck	BBHA9120D	1187	01/11/2021	01/10/2022
Loop Antenna	ETS.LINDGR EN	6502	143303	05/07/2021	05/06/2022
EMI Test Receiver	R&S	ESU 40	100363	04/28/2021	04/27/2022
Bluetooth Test Set	R&S	CBT	101140	05/04/2020	05/03/2021
Pre-Amplifier	EMC Instruments	EMC330	980096	11/19/2020	11/18/2021
Pre-Amplifier	EMC Instruments	EMC0011830	980199	11/19/2020	11/18/2021
Pre-Amplifier	EMC Instruments	EMC184045B	980135	10/27/2020	10/26/2021
Attenuator	Marvelous	WATT-218FS- 10	RF20	11/19/2020	11/18/2021
Band Rejection Filter	Micro-Tronics	BRM50701-01	RF201	11/19/2020	11/18/2021
Coaxial Cable	Huber Suhner	SUCOFLEX 104	MY17388/4	11/19/2020	11/18/2021
Coaxial Cable	Huber Suhner	RG 214/U	W22.03	11/19/2020	11/18/2021
Test Software	audix	e3	20923 sgs Ver.9	N.C.R	N.C.R
Notebook	Lenovo	L440	P0000367	N/A	N/A

**NOTE:** N.C.R refers to Not Calibrated Required.

Unless otherwise stated the results shown in this test report refer only to the sample(s) tested and such sample(s) are retained for 90 days only.

除非另有說明，此報告結果僅對測試之樣品負責，同時此樣品僅保留90天。本報告未經本公司書面許可，不可部份複製。

This document is issued by the Company subject to its General Conditions of Service printed overleaf, available on request or accessible at <http://www.sgs.com.tw/Terms-and-Conditions> and for electronic format documents, subject to Terms and Conditions for Electronic Documents at <http://www.sgs.com.tw/Terms-and-Conditions>. Attention is drawn to the limitation of liability, indemnification and jurisdiction issues defined therein. Any holder of this document is advised that information contained hereon reflects the Company's findings at the time of its intervention only and within the limits of Client's instructions, if any. The Company's sole responsibility is to its Client and this document does not exonerate parties to a transaction from exercising all their rights and obligations under the transaction documents. This document cannot be reproduced except in full, without prior written approval of the Company. Any unauthorized alteration, forgery or falsification of the content or appearance of this document is unlawful and offenders may be prosecuted to the fullest extent of the law.

### 10.3 Test SET-UP

#### 10.3.1 Duty Cycle Correction Factor

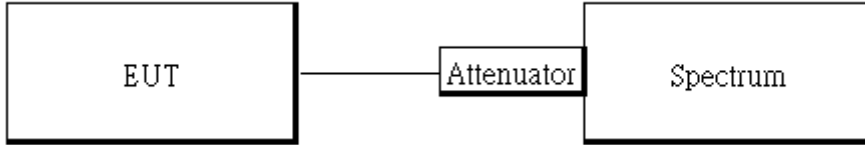

#### 10.3.2 Radiated Emission

##### (A) Radiated Emission Test Set-Up, Frequency Below 30MHz.

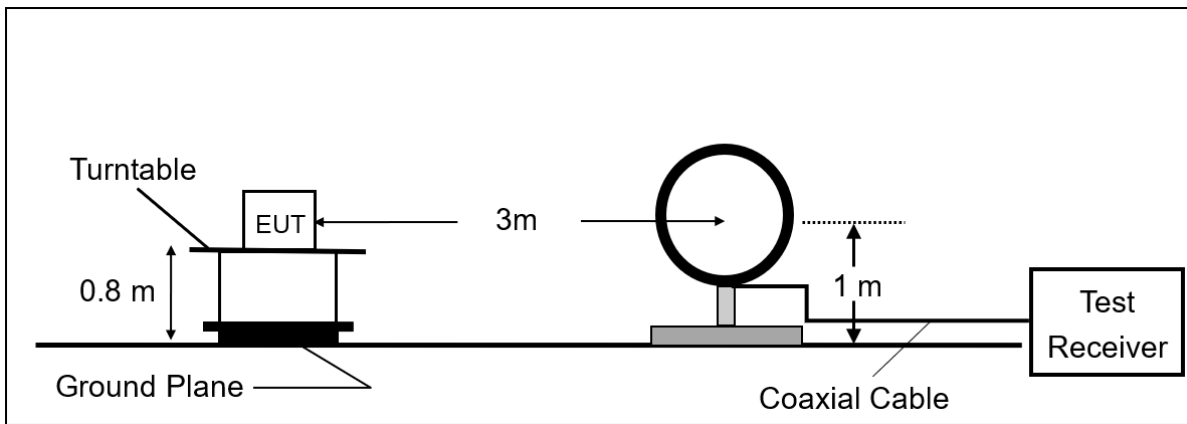

##### (B) Radiated Emission Test Set-Up, Frequency From 30MHz to 1000MHz.

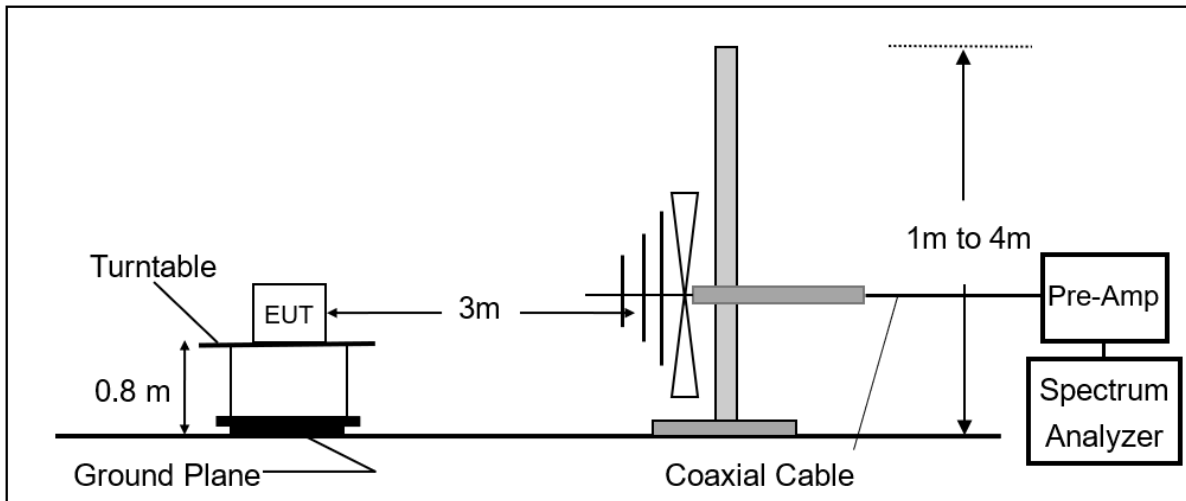

Unless otherwise stated the results shown in this test report refer only to the sample(s) tested and such sample(s) are retained for 90 days only.

除非另有說明，此報告結果僅對測試之樣品負責，同時此樣品僅保留90天。本報告未經本公司書面許可，不可部份複製。

This document is issued by the Company subject to its General Conditions of Service printed overleaf, available on request or accessible at <http://www.sgs.com.tw/Terms-and-Conditions> and for electronic format documents, subject to Terms and Conditions for Electronic Documents at <http://www.sgs.com.tw/Terms-and-Conditions>. Attention is drawn to the limitation of liability, indemnification and jurisdiction issues defined therein. Any holder of this document is advised that information contained hereon reflects the Company's findings at the time of its intervention only and within the limits of Client's instructions, if any. The Company's sole responsibility is to its Client and this document does not exonerate parties to a transaction from exercising all their rights and obligations under the transaction documents. This document cannot be reproduced except in full, without prior written approval of the Company. Any unauthorized alteration, forgery or falsification of the content or appearance of this document is unlawful and offenders may be prosecuted to the fullest extent of the law.

(C) Radiated Emission Test Set-Up, Frequency Above 1 GHz.

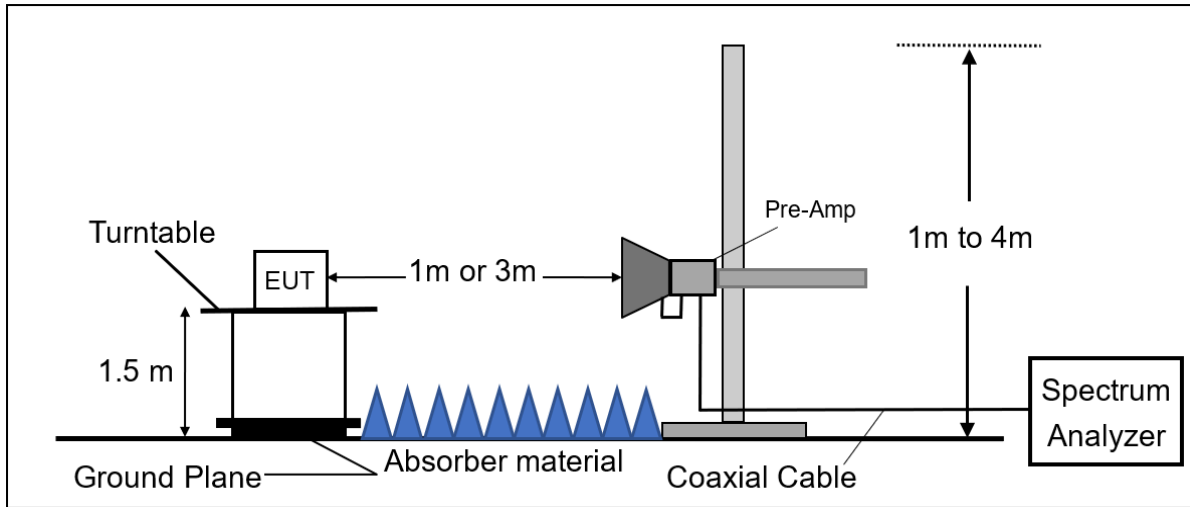

Unless otherwise stated the results shown in this test report refer only to the sample(s) tested and such sample(s) are retained for 90 days only.

除非另有說明，此報告結果僅對測試之樣品負責，同時此樣品僅保留90天。本報告未經本公司書面許可，不可部份複製。

This document is issued by the Company subject to its General Conditions of Service printed overleaf, available on request or accessible at <http://www.sgs.com.tw/Terms-and-Conditions> and for electronic format documents, subject to Terms and Conditions for Electronic Documents at <http://www.sgs.com.tw/Terms-and-Conditions>. Attention is drawn to the limitation of liability, indemnification and jurisdiction issues defined therein. Any holder of this document is advised that information contained hereon reflects the Company's findings at the time of its intervention only and within the limits of Client's instructions, if any. The Company's sole responsibility is to its Client and this document does not exonerate parties to a transaction from exercising all their rights and obligations under the transaction documents. This document cannot be reproduced except in full, without prior written approval of the Company. Any unauthorized alteration, forgery or falsification of the content or appearance of this document is unlawful and offenders may be prosecuted to the fullest extent of the law.

#### 10.4 Measurement Procedure

1. The testing follows the Measurement Procedure of ANSI C63.10:2013.
2. The EUT was placed on a turn table with 0.8m for frequency < 1GHz and 1.5m for frequency > 1GHz above ground plane.
3. The turn table shall rotate 360 degrees to determine the position of maximum emission level.
4. EUT is set 3m away from the receiving antenna which varied from 1m to 4m to find out the highest emissions.
5. Set the spectrum analyzer as RBW=100 kHz and VBW=300 kHz for Peak Detector (PK) at frequency between 30MHz and 1 GHz.
6. Use receiver mode as RBW=120 kHz for Quasi-peak (QP) at frequency between 30MHz and 1 GHz.
7. Set the spectrum analyzer as RBW=1 MHz, VBW=3 MHz for Maximum Emission Measurements at frequency above 1 GHz.
8. According to C63.10:2013 Section 7.5 Procedure for determining the average value of pulsed emissions with duty cycle correction factor  $20 \log (T_{on}/100ms)$ .
9. When measurement procedures for electric field radiated emissions above 1 GHz the EUT measurement is to be made "while keeping the antenna in the 'cone of radiation' from that area and pointed at the area both in azimuth and elevation, with polarization oriented for maximum response." is still within the 3dB illumination BW of the measurement antenna.
10. Maximum procedure was performed on the six highest emissions to ensure EUT compliance.
11. And also, each emission was to be maximized by changing the polarization of receiving antenna both horizontal and vertical.
12. Repeat above procedures until all default test channel measured were complete.

Unless otherwise stated the results shown in this test report refer only to the sample(s) tested and such sample(s) are retained for 90 days only.

除非另有說明，此報告結果僅對測試之樣品負責，同時此樣品僅保留90天。本報告未經本公司書面許可，不可部份複製。

This document is issued by the Company subject to its General Conditions of Service printed overleaf, available on request or accessible at <http://www.sgs.com.tw/Terms-and-Conditions> and for electronic format documents, subject to Terms and Conditions for Electronic Documents at <http://www.sgs.com.tw/Terms-and-Conditions>. Attention is drawn to the limitation of liability, indemnification and jurisdiction issues defined therein. Any holder of this document is advised that information contained hereon reflects the Company's findings at the time of its intervention only and within the limits of Client's instructions, if any. The Company's sole responsibility is to its Client and this document does not exonerate parties to a transaction from exercising all their rights and obligations under the transaction documents. This document cannot be reproduced except in full, without prior written approval of the Company. Any unauthorized alteration, forgery or falsification of the content or appearance of this document is unlawful and offenders may be prosecuted to the fullest extent of the law.

### 10.5 Field Strength Calculation

The field strength is calculated by adding the Antenna Factor and Cable Factor and subtracting the Amplifier Gain and Duty Cycle Correction Factor (if any) from the measured reading. The basic equation with a sample calculation is as follows:

$$FS = RA + AF + CL - AG$$

**Where** *FS* = Field Strength

*RA* = Reading Amplitude

*AF* = Antenna Factor

*CL* = Cable Attenuation Factor (Cable Loss)

*AG* = Amplifier Gain

The limit of the emission level is expressed in dBuV/m, which converts  $20 \cdot \log(uV/m)$

Actual FS(dBμV/m) = SPA. Reading level(dBμV) + Factor(dB)

Factor(dB) = Antenna Factor(dBμV/m) + Cable Loss(dB) – Pre\_Amplifier Gain(dB)

### 10.6 Test Results of Radiated Spurious Emissions form 9 kHz to 30 MHz

The low frequency, which started from 9 kHz to 30MHz, was pre-scanned and the result which was 20dB lower than the limit per 15.31(o) & RSS-GEN §6.13.2 was not reported.

Unless otherwise stated the results shown in this test report refer only to the sample(s) tested and such sample(s) are retained for 90 days only.

除非另有說明，此報告結果僅對測試之樣品負責，同時此樣品僅保留90天。本報告未經本公司書面許可，不可部份複製。

This document is issued by the Company subject to its General Conditions of Service printed overleaf, available on request or accessible at <http://www.sgs.com.tw/Terms-and-Conditions> and for electronic format documents, subject to Terms and Conditions for Electronic Documents at <http://www.sgs.com.tw/Terms-and-Conditions>. Attention is drawn to the limitation of liability, indemnification and jurisdiction issues defined therein. Any holder of this document is advised that information contained hereon reflects the Company's findings at the time of its intervention only and within the limits of Client's instructions, if any. The Company's sole responsibility is to its Client and this document does not exonerate parties to a transaction from exercising all their rights and obligations under the transaction documents. This document cannot be reproduced except in full, without prior written approval of the Company. Any unauthorized alteration, forgery or falsification of the content or appearance of this document is unlawful and offenders may be prosecuted to the fullest extent of the law.

### 10.7 Measurement Result:

#### 10.7.1 Bandedge Result

Report Number	:E2/2021/70052	Test Site	:SAC C
Operation Mode	:BT BR	Test Date	:2021-08-04
Test Frequency	:2402 MHz	Temp./Humi.	:25.0/54
Test Mode	:BE CH LOW	Antenna Pol.	:Vertical
EUT Pol	:E2 Plane	Engineer	:Enzo Chang

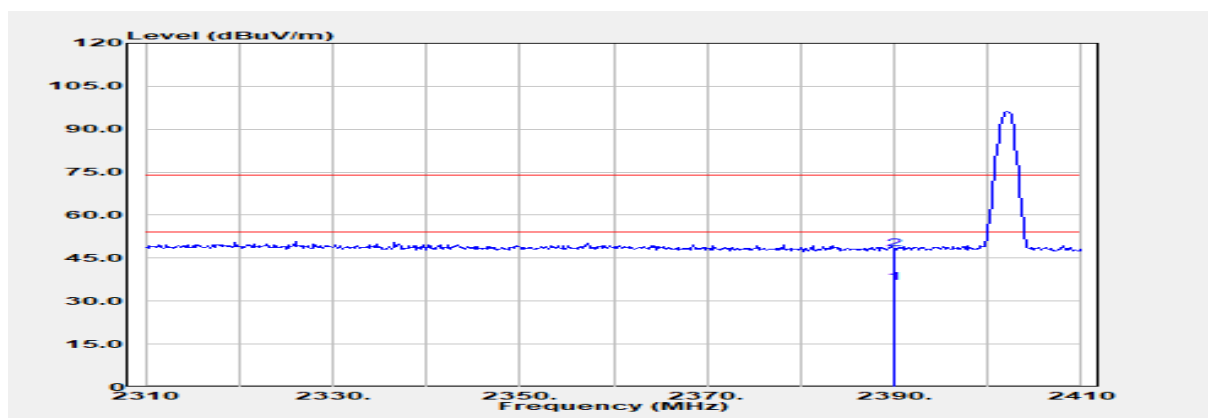

Freq. MHz	Detector Mode PK/QP/AV	Spectrum Reading Level dBμV	Factor dB	Actual FS dBμV/m	Limit @3m dBμV/m	Margin dB
2390.000	Average	31.09	5.18	36.27	54.00	-17.73
2390.000	Peak	42.99	5.18	48.17	74.00	-25.83

Unless otherwise stated the results shown in this test report refer only to the sample(s) tested and such sample(s) are retained for 90 days only.

除非另有說明，此報告結果僅對測試之樣品負責，同時此樣品僅保留90天。本報告未經本公司書面許可，不可部份複製。  
 This document is issued by the Company subject to its General Conditions of Service printed overleaf, available on request or accessible at <http://www.sgs.com.tw/Terms-and-Conditions> and for electronic format documents, subject to Terms and Conditions for Electronic Documents at <http://www.sgs.com.tw/Terms-and-Conditions>. Attention is drawn to the limitation of liability, indemnification and jurisdiction issues defined therein. Any holder of this document is advised that information contained hereon reflects the Company's findings at the time of its intervention only and within the limits of Client's instructions, if any. The Company's sole responsibility is to its Client and this document does not exonerate parties to a transaction from exercising all their rights and obligations under the transaction documents. This document cannot be reproduced except in full, without prior written approval of the Company. Any unauthorized alteration, forgery or falsification of the content or appearance of this document is unlawful and offenders may be prosecuted to the fullest extent of the law.



Report Number :E2/2021/70052  
 Operation Mode :BT BR  
 Test Frequency :2402 MHz  
 Test Mode :BE CH LOW  
 EUT Pol :E2 Plane

Test Site :SAC C  
 Test Date :2021-08-04  
 Temp./Humi. :25.0/54  
 Antenna Pol. :Horizontal  
 Engineer :Enzo Chang

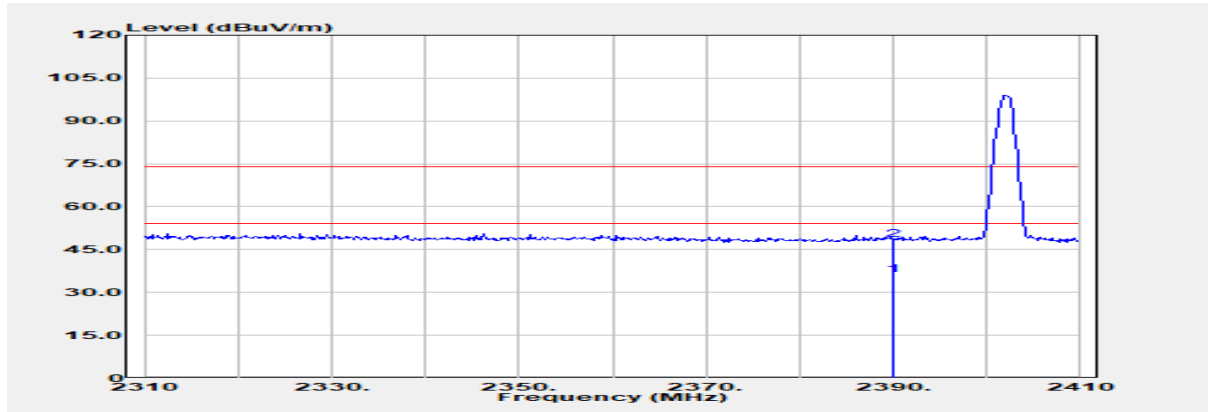

Freq. MHz	Detector Mode PK/QP/AV	Spectrum Reading Level dB $\mu$ V	Factor dB	Actual FS dB $\mu$ V/m	Limit @3m dB $\mu$ V/m	Margin dB
2390.000	Average	30.98	5.18	36.16	54.00	-17.84
2390.000	Peak	43.36	5.18	48.54	74.00	-25.46

Unless otherwise stated the results shown in this test report refer only to the sample(s) tested and such sample(s) are retained for 90 days only.

除非另有說明，此報告結果僅對測試之樣品負責，同時此樣品僅保留90天。本報告未經本公司書面許可，不可部份複製。  
 This document is issued by the Company subject to its General Conditions of Service printed overleaf, available on request or accessible at <http://www.sgs.com.tw/Terms-and-Conditions> and for electronic format documents, subject to Terms and Conditions for Electronic Documents at <http://www.sgs.com.tw/Terms-and-Conditions>. Attention is drawn to the limitation of liability, indemnification and jurisdiction issues defined therein. Any holder of this document is advised that information contained hereon reflects the Company's findings at the time of its intervention only and within the limits of Client's instructions, if any. The Company's sole responsibility is to its Client and this document does not exonerate parties to a transaction from exercising all their rights and obligations under the transaction documents. This document cannot be reproduced except in full, without prior written approval of the Company. Any unauthorized alteration, forgery or falsification of the content or appearance of this document is unlawful and offenders may be prosecuted to the fullest extent of the law.

Report Number :E2/2021/70052  
 Operation Mode :BT BR  
 Test Frequency :2480 MHz  
 Test Mode :BE CH HIGH  
 EUT Pol :E2 Plane

Test Site :SAC C  
 Test Date :2021-08-04  
 Temp./Humi. :25.0/54  
 Antenna Pol. :Vertical  
 Engineer :Enzo Chang

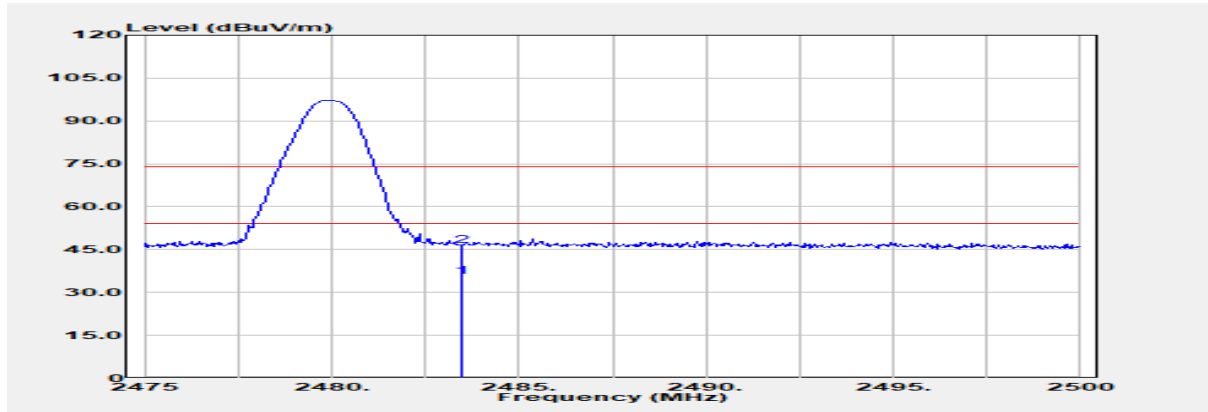

Freq. MHz	Detector Mode PK/QP/AV	Spectrum Reading Level dB $\mu$ V	Factor dB	Actual FS dB $\mu$ V/m	Limit @3m dB $\mu$ V/m	Margin dB
2483.500	Average	31.32	4.04	35.36	54.00	-18.64
2483.500	Peak	42.35	4.04	46.39	74.00	-27.61

Unless otherwise stated the results shown in this test report refer only to the sample(s) tested and such sample(s) are retained for 90 days only.

除非另有說明，此報告結果僅對測試之樣品負責，同時此樣品僅保留90天。本報告未經本公司書面許可，不可部份複製。

This document is issued by the Company subject to its General Conditions of Service printed overleaf, available on request or accessible at <http://www.sgs.com.tw/Terms-and-Conditions> and for electronic format documents, subject to Terms and Conditions for Electronic Documents at <http://www.sgs.com.tw/Terms-and-Conditions>. Attention is drawn to the limitation of liability, indemnification and jurisdiction issues defined therein. Any holder of this document is advised that information contained hereon reflects the Company's findings at the time of its intervention only and within the limits of Client's instructions, if any. The Company's sole responsibility is to its Client and this document does not exonerate parties to a transaction from exercising all their rights and obligations under the transaction documents. This document cannot be reproduced except in full, without prior written approval of the Company. Any unauthorized alteration, forgery or falsification of the content or appearance of this document is unlawful and offenders may be prosecuted to the fullest extent of the law.

Report Number :E2/2021/70052  
 Operation Mode :BT BR  
 Test Frequency :2480 MHz  
 Test Mode :BE CH HIGH  
 EUT Pol :E2 Plane

Test Site :SAC C  
 Test Date :2021-08-04  
 Temp./Humi. :25.0/54  
 Antenna Pol. :Horizontal  
 Engineer :Enzo Chang

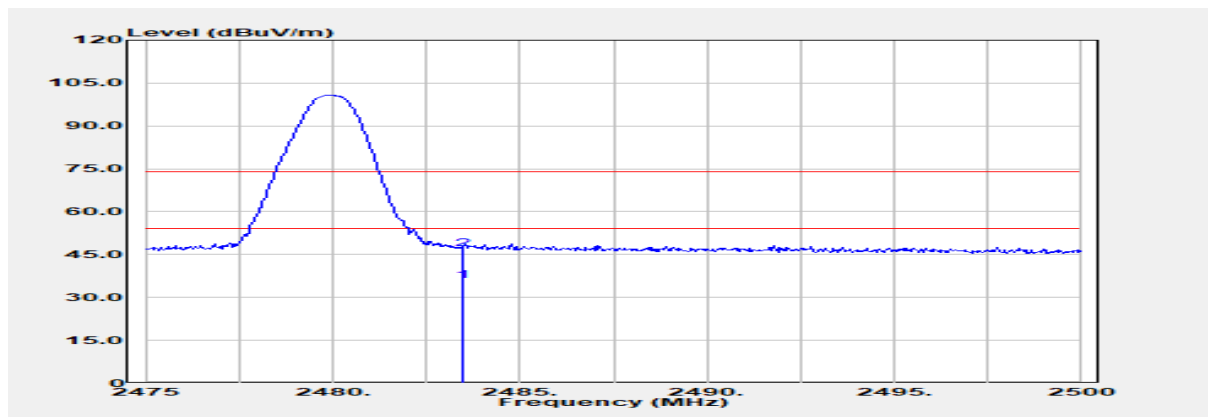

Freq. MHz	Detector Mode PK/QP/AV	Spectrum Reading Level dBμV	Factor dB	Actual FS dBμV/m	Limit @3m dBμV/m	Margin dB
2483.500	Average	31.81	4.04	35.85	54.00	-18.15
2483.500	Peak	42.79	4.04	46.82	74.00	-27.18

Unless otherwise stated the results shown in this test report refer only to the sample(s) tested and such sample(s) are retained for 90 days only.

除非另有說明，此報告結果僅對測試之樣品負責，同時此樣品僅保留90天。本報告未經本公司書面許可，不可部份複製。

This document is issued by the Company subject to its General Conditions of Service printed overleaf, available on request or accessible at <http://www.sgs.com.tw/Terms-and-Conditions> and for electronic format documents, subject to Terms and Conditions for Electronic Documents at <http://www.sgs.com.tw/Terms-and-Conditions>. Attention is drawn to the limitation of liability, indemnification and jurisdiction issues defined therein. Any holder of this document is advised that information contained hereon reflects the Company's findings at the time of its intervention only and within the limits of Client's instructions, if any. The Company's sole responsibility is to its Client and this document does not exonerate parties to a transaction from exercising all their rights and obligations under the transaction documents. This document cannot be reproduced except in full, without prior written approval of the Company. Any unauthorized alteration, forgery or falsification of the content or appearance of this document is unlawful and offenders may be prosecuted to the fullest extent of the law.

Report Number :E2/2021/70052  
 Operation Mode :BT BR Hopping  
 Test Frequency :2402 MHz  
 Test Mode :BE CH LOW  
 EUT Pol :E2 Plane

Test Site :SAC C  
 Test Date :2021-08-04  
 Temp./Humi. :25.0/54  
 Antenna Pol. :Vertical  
 Engineer :Enzo Chang

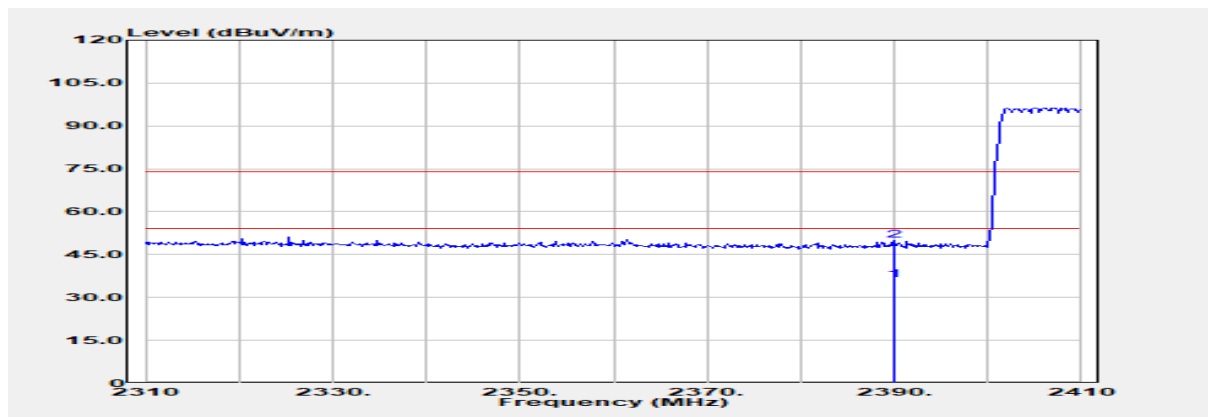

Freq. MHz	Detector Mode PK/QP/AV	Spectrum Reading Level dB $\mu$ V	Factor dB	Actual FS dB $\mu$ V/m	Limit @3m dB $\mu$ V/m	Margin dB
2390.000	Average	30.93	5.18	36.11	54.00	-17.89
2390.000	Peak	44.68	5.18	49.86	74.00	-24.14

Unless otherwise stated the results shown in this test report refer only to the sample(s) tested and such sample(s) are retained for 90 days only.

除非另有說明，此報告結果僅對測試之樣品負責，同時此樣品僅保留90天。本報告未經本公司書面許可，不可部份複製。

This document is issued by the Company subject to its General Conditions of Service printed overleaf, available on request or accessible at <http://www.sgs.com.tw/Terms-and-Conditions> and for electronic format documents, subject to Terms and Conditions for Electronic Documents at <http://www.sgs.com.tw/Terms-and-Conditions>. Attention is drawn to the limitation of liability, indemnification and jurisdiction issues defined therein. Any holder of this document is advised that information contained hereon reflects the Company's findings at the time of its intervention only and within the limits of Client's instructions, if any. The Company's sole responsibility is to its Client and this document does not exonerate parties to a transaction from exercising all their rights and obligations under the transaction documents. This document cannot be reproduced except in full, without prior written approval of the Company. Any unauthorized alteration, forgery or falsification of the content or appearance of this document is unlawful and offenders may be prosecuted to the fullest extent of the law.

Report Number :E2/2021/70052  
 Operation Mode :BT BR Hopping  
 Test Frequency :2402 MHz  
 Test Mode :BE CH LOW  
 EUT Pol :E2 Plane

Test Site :SAC C  
 Test Date :2021-08-04  
 Temp./Humi. :25.0/54  
 Antenna Pol. :Horizontal  
 Engineer :Enzo Chang

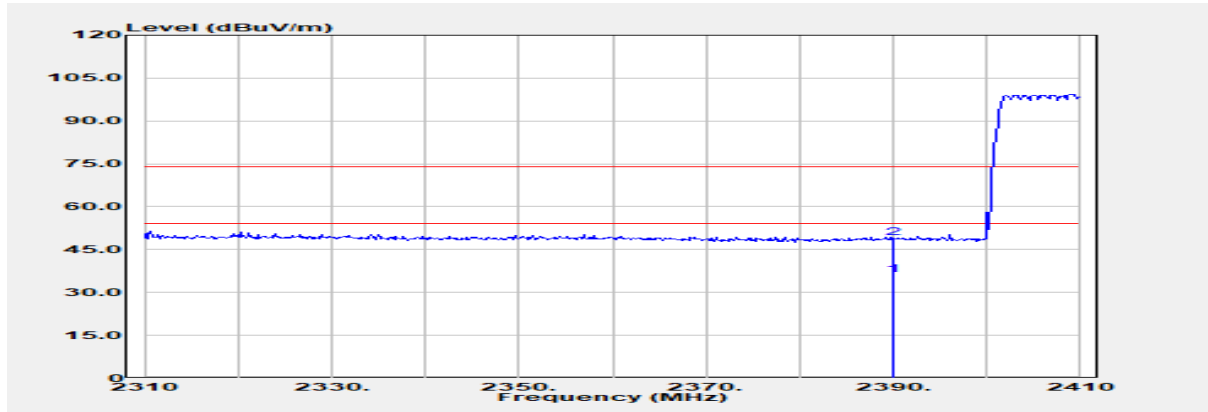

Freq. MHz	Detector Mode PK/QP/AV	Spectrum Reading Level dB $\mu$ V	Factor dB	Actual FS dB $\mu$ V/m	Limit @3m dB $\mu$ V/m	Margin dB
2390.000	Average	30.93	5.18	36.11	54.00	-17.89
2390.000	Peak	43.99	5.18	49.17	74.00	-24.83

Unless otherwise stated the results shown in this test report refer only to the sample(s) tested and such sample(s) are retained for 90 days only.

除非另有說明，此報告結果僅對測試之樣品負責，同時此樣品僅保留90天。本報告未經本公司書面許可，不可部份複製。

This document is issued by the Company subject to its General Conditions of Service printed overleaf, available on request or accessible at <http://www.sgs.com.tw/Terms-and-Conditions> and for electronic format documents, subject to Terms and Conditions for Electronic Documents at <http://www.sgs.com.tw/Terms-and-Conditions>. Attention is drawn to the limitation of liability, indemnification and jurisdiction issues defined therein. Any holder of this document is advised that information contained hereon reflects the Company's findings at the time of its intervention only and within the limits of Client's instructions, if any. The Company's sole responsibility is to its Client and this document does not exonerate parties to a transaction from exercising all their rights and obligations under the transaction documents. This document cannot be reproduced except in full, without prior written approval of the Company. Any unauthorized alteration, forgery or falsification of the content or appearance of this document is unlawful and offenders may be prosecuted to the fullest extent of the law.

Report Number :E2/2021/70052  
 Operation Mode :BT BR Hopping  
 Test Frequency :2480 MHz  
 Test Mode :BE CH HIGH  
 EUT Pol :E2 Plane

Test Site :SAC C  
 Test Date :2021-08-04  
 Temp./Humi. :25.0/54  
 Antenna Pol. :Vertical  
 Engineer :Enzo Chang

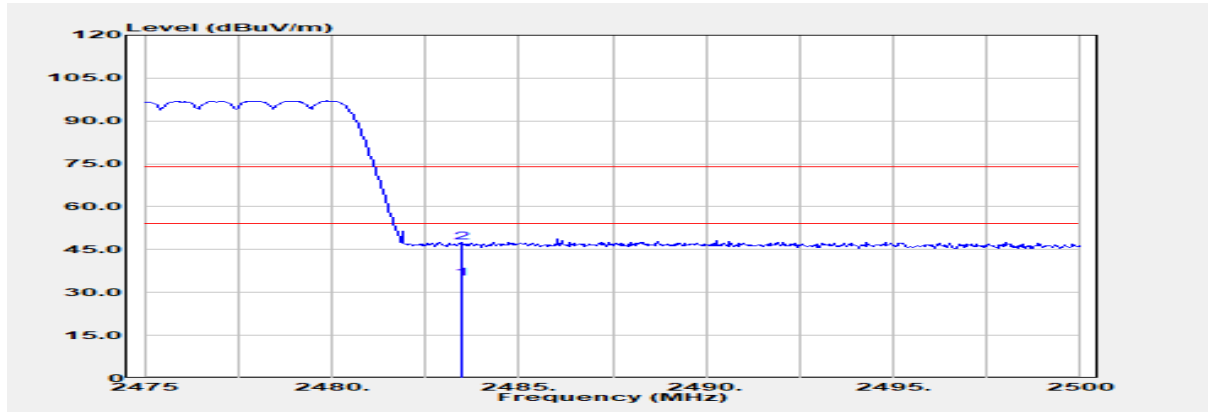

Freq. MHz	Detector Mode PK/QP/AV	Spectrum Reading Level dB $\mu$ V	Factor dB	Actual FS dB $\mu$ V/m	Limit @3m dB $\mu$ V/m	Margin dB
2483.500	Average	30.94	4.04	34.98	54.00	-19.02
2483.500	Peak	43.54	4.04	47.57	74.00	-26.43

Unless otherwise stated the results shown in this test report refer only to the sample(s) tested and such sample(s) are retained for 90 days only.

除非另有說明，此報告結果僅對測試之樣品負責，同時此樣品僅保留90天。本報告未經本公司書面許可，不可部份複製。

This document is issued by the Company subject to its General Conditions of Service printed overleaf, available on request or accessible at <http://www.sgs.com.tw/Terms-and-Conditions> and for electronic format documents, subject to Terms and Conditions for Electronic Documents at <http://www.sgs.com.tw/Terms-and-Conditions>. Attention is drawn to the limitation of liability, indemnification and jurisdiction issues defined therein. Any holder of this document is advised that information contained hereon reflects the Company's findings at the time of its intervention only and within the limits of Client's instructions, if any. The Company's sole responsibility is to its Client and this document does not exonerate parties to a transaction from exercising all their rights and obligations under the transaction documents. This document cannot be reproduced except in full, without prior written approval of the Company. Any unauthorized alteration, forgery or falsification of the content or appearance of this document is unlawful and offenders may be prosecuted to the fullest extent of the law.

Report Number :E2/2021/70052  
 Operation Mode :BT BR Hopping  
 Test Frequency :2480 MHz  
 Test Mode :BE CH HIGH  
 EUT Pol :E2 Plane

Test Site :SAC C  
 Test Date :2021-08-04  
 Temp./Humi. :25.0/54  
 Antenna Pol. :Horizontal  
 Engineer :Enzo Chang

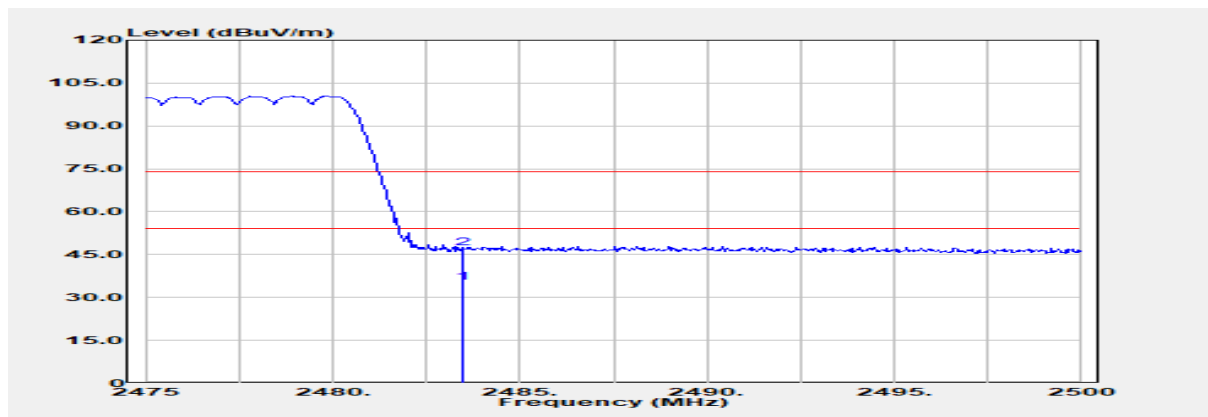

Freq. MHz	Detector Mode PK/QP/AV	Spectrum Reading Level dBμV	Factor dB	Actual FS dBμV/m	Limit @3m dBμV/m	Margin dB
2483.500	Average	31.06	4.04	35.10	54.00	-18.90
2483.500	Peak	43.07	4.04	47.11	74.00	-26.89

Unless otherwise stated the results shown in this test report refer only to the sample(s) tested and such sample(s) are retained for 90 days only.

除非另有說明，此報告結果僅對測試之樣品負責，同時此樣品僅保留90天。本報告未經本公司書面許可，不可部份複製。  
 This document is issued by the Company subject to its General Conditions of Service printed overleaf, available on request or accessible at <http://www.sgs.com.tw/Terms-and-Conditions> and for electronic format documents, subject to Terms and Conditions for Electronic Documents at <http://www.sgs.com.tw/Terms-and-Conditions>. Attention is drawn to the limitation of liability, indemnification and jurisdiction issues defined therein. Any holder of this document is advised that information contained hereon reflects the Company's findings at the time of its intervention only and within the limits of Client's instructions, if any. The Company's sole responsibility is to its Client and this document does not exonerate parties to a transaction from exercising all their rights and obligations under the transaction documents. This document cannot be reproduced except in full, without prior written approval of the Company. Any unauthorized alteration, forgery or falsification of the content or appearance of this document is unlawful and offenders may be prosecuted to the fullest extent of the law.



Report Number :E2/2021/70052  
 Operation Mode :BT EDR  
 Test Frequency :2402 MHz  
 Test Mode :BE CH LOW  
 EUT Pol :E2 Plane

Test Site :SAC C  
 Test Date :2021-08-04  
 Temp./Humi. :24.9/52  
 Antenna Pol. :Vertical  
 Engineer :Enzo Chang

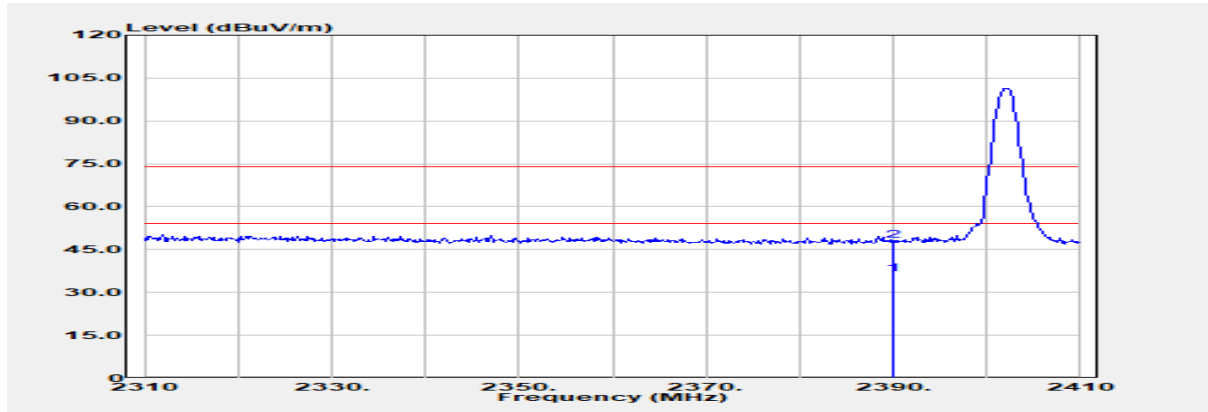

Freq. MHz	Detector Mode PK/QP/AV	Spectrum Reading Level dB $\mu$ V	Factor dB	Actual FS dB $\mu$ V/m	Limit @3m dB $\mu$ V/m	Margin dB
2390.000	Average	31.11	5.18	36.29	54.00	-17.71
2390.000	Peak	42.92	5.18	48.10	74.00	-25.90

Unless otherwise stated the results shown in this test report refer only to the sample(s) tested and such sample(s) are retained for 90 days only.

除非另有說明，此報告結果僅對測試之樣品負責，同時此樣品僅保留90天。本報告未經本公司書面許可，不可部份複製。  
 This document is issued by the Company subject to its General Conditions of Service printed overleaf, available on request or accessible at <http://www.sgs.com.tw/Terms-and-Conditions> and for electronic format documents, subject to Terms and Conditions for Electronic Documents at <http://www.sgs.com.tw/Terms-and-Conditions>. Attention is drawn to the limitation of liability, indemnification and jurisdiction issues defined therein. Any holder of this document is advised that information contained hereon reflects the Company's findings at the time of its intervention only and within the limits of Client's instructions, if any. The Company's sole responsibility is to its Client and this document does not exonerate parties to a transaction from exercising all their rights and obligations under the transaction documents. This document cannot be reproduced except in full, without prior written approval of the Company. Any unauthorized alteration, forgery or falsification of the content or appearance of this document is unlawful and offenders may be prosecuted to the fullest extent of the law.

Report Number :E2/2021/70052  
Operation Mode :BT EDR  
Test Frequency :2402 MHz  
Test Mode :BE CH LOW  
EUT Pol :E2 Plane

Test Site :SAC C  
Test Date :2021-08-04  
Temp./Humi. :24.9/52  
Antenna Pol. :Horizontal  
Engineer :Enzo Chang

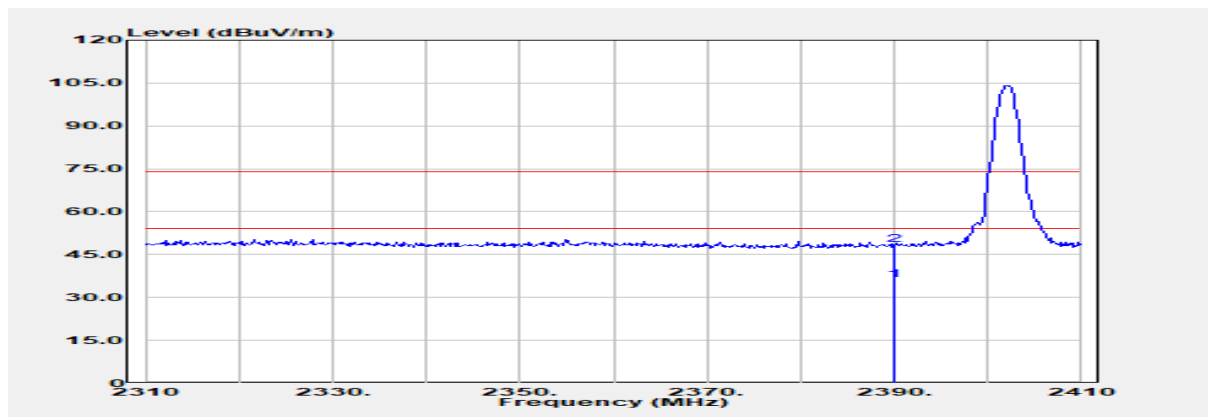

Freq. MHz	Detector Mode PK/QP/AV	Spectrum Reading Level dB $\mu$ V	Factor dB	Actual FS dB $\mu$ V/m	Limit @3m dB $\mu$ V/m	Margin dB
2390.000	Average	31.03	5.18	36.21	54.00	-17.79
2390.000	Peak	43.18	5.18	48.36	74.00	-25.64

Unless otherwise stated the results shown in this test report refer only to the sample(s) tested and such sample(s) are retained for 90 days only.

除非另有說明，此報告結果僅對測試之樣品負責，同時此樣品僅保留90天。本報告未經本公司書面許可，不可部份複製。

This document is issued by the Company subject to its General Conditions of Service printed overleaf, available on request or accessible at <http://www.sgs.com.tw/Terms-and-Conditions> and for electronic format documents, subject to Terms and Conditions for Electronic Documents at <http://www.sgs.com.tw/Terms-and-Conditions>. Attention is drawn to the limitation of liability, indemnification and jurisdiction issues defined therein. Any holder of this document is advised that information contained hereon reflects the Company's findings at the time of its intervention only and within the limits of Client's instructions, if any. The Company's sole responsibility is to its Client and this document does not exonerate parties to a transaction from exercising all their rights and obligations under the transaction documents. This document cannot be reproduced except in full, without prior written approval of the Company. Any unauthorized alteration, forgery or falsification of the content or appearance of this document is unlawful and offenders may be prosecuted to the fullest extent of the law.

Report Number :E2/2021/70052  
Operation Mode :BT EDR  
Test Frequency :2480 MHz  
Test Mode :BE CH HIGH  
EUT Pol :E2 Plane

Test Site :SAC C  
Test Date :2021-08-04  
Temp./Humi. :24.9/52  
Antenna Pol. :Vertical  
Engineer :Enzo Chang

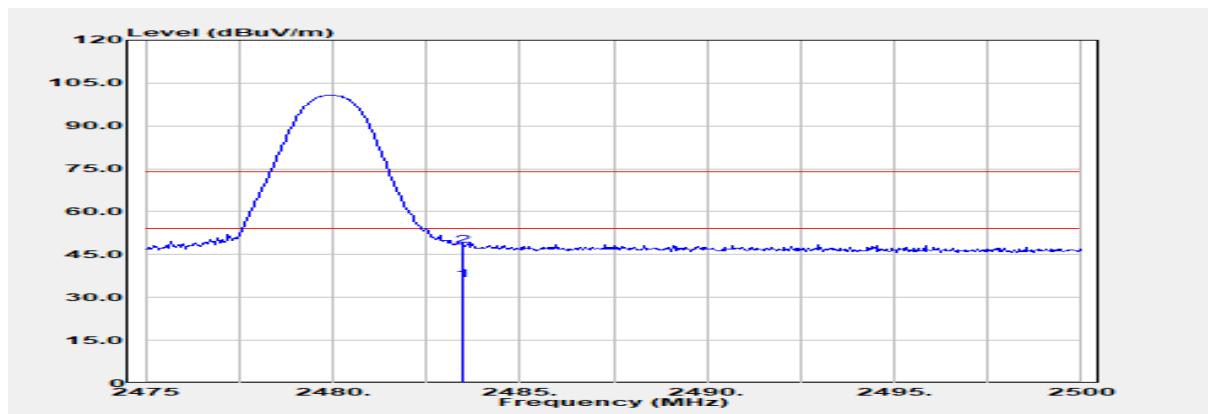

Freq. MHz	Detector Mode PK/QP/AV	Spectrum Reading Level dB $\mu$ V	Factor dB	Actual FS dB $\mu$ V/m	Limit @3m dB $\mu$ V/m	Margin dB
2483.500	Average	32.15	4.04	36.19	54.00	-17.81
2483.500	Peak	44.16	4.04	48.19	74.00	-25.81

Unless otherwise stated the results shown in this test report refer only to the sample(s) tested and such sample(s) are retained for 90 days only.

除非另有說明，此報告結果僅對測試之樣品負責，同時此樣品僅保留90天。本報告未經本公司書面許可，不可部份複製。  
This document is issued by the Company subject to its General Conditions of Service printed overleaf, available on request or accessible at <http://www.sgs.com.tw/Terms-and-Conditions> and for electronic format documents, subject to Terms and Conditions for Electronic Documents at <http://www.sgs.com.tw/Terms-and-Conditions>. Attention is drawn to the limitation of liability, indemnification and jurisdiction issues defined therein. Any holder of this document is advised that information contained hereon reflects the Company's findings at the time of its intervention only and within the limits of Client's instructions, if any. The Company's sole responsibility is to its Client and this document does not exonerate parties to a transaction from exercising all their rights and obligations under the transaction documents. This document cannot be reproduced except in full, without prior written approval of the Company. Any unauthorized alteration, forgery or falsification of the content or appearance of this document is unlawful and offenders may be prosecuted to the fullest extent of the law.

Report Number :E2/2021/70052  
 Operation Mode :BT EDR  
 Test Frequency :2480 MHz  
 Test Mode :BE CH HIGH  
 EUT Pol :E2 Plane

Test Site :SAC C  
 Test Date :2021-08-04  
 Temp./Humi. :24.9/52  
 Antenna Pol. :Horizontal  
 Engineer :Enzo Chang

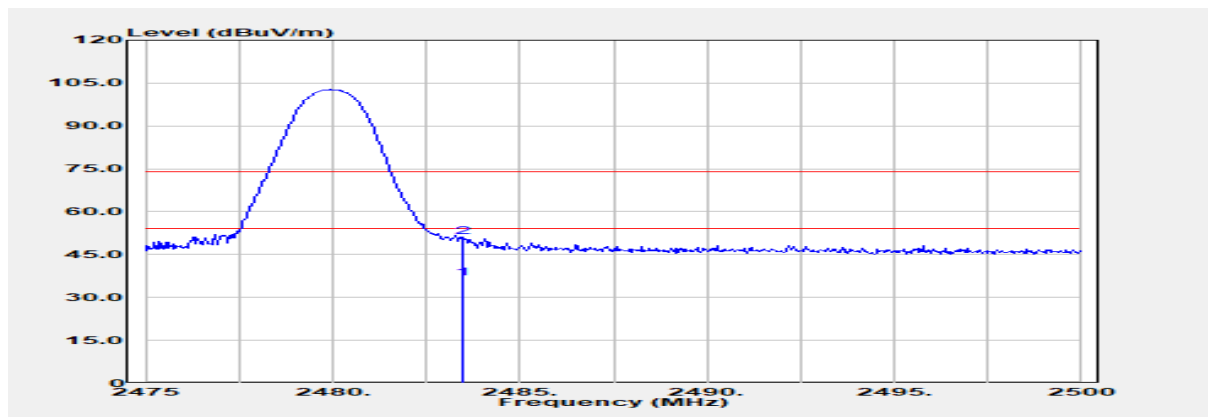

Freq. MHz	Detector Mode PK/QP/AV	Spectrum Reading Level dB $\mu$ V	Factor dB	Actual FS dB $\mu$ V/m	Limit @3m dB $\mu$ V/m	Margin dB
2483.500	Average	32.63	4.04	36.67	54.00	-17.33
2483.500	Peak	47.14	4.04	51.17	74.00	-22.83

Unless otherwise stated the results shown in this test report refer only to the sample(s) tested and such sample(s) are retained for 90 days only.

除非另有說明，此報告結果僅對測試之樣品負責，同時此樣品僅保留90天。本報告未經本公司書面許可，不可部份複製。

This document is issued by the Company subject to its General Conditions of Service printed overleaf, available on request or accessible at <http://www.sgs.com.tw/Terms-and-Conditions> and for electronic format documents, subject to Terms and Conditions for Electronic Documents at <http://www.sgs.com.tw/Terms-and-Conditions>. Attention is drawn to the limitation of liability, indemnification and jurisdiction issues defined therein. Any holder of this document is advised that information contained hereon reflects the Company's findings at the time of its intervention only and within the limits of Client's instructions, if any. The Company's sole responsibility is to its Client and this document does not exonerate parties to a transaction from exercising all their rights and obligations under the transaction documents. This document cannot be reproduced except in full, without prior written approval of the Company. Any unauthorized alteration, forgery or falsification of the content or appearance of this document is unlawful and offenders may be prosecuted to the fullest extent of the law.

Report Number :E2/2021/70052  
 Operation Mode :BT EDR Hopping  
 Test Frequency :2402 MHz  
 Test Mode :BE CH LOW  
 EUT Pol :E2 Plane

Test Site :SAC C  
 Test Date :2021-08-04  
 Temp./Humi. :24.9/52  
 Antenna Pol. :Vertical  
 Engineer :Enzo Chang

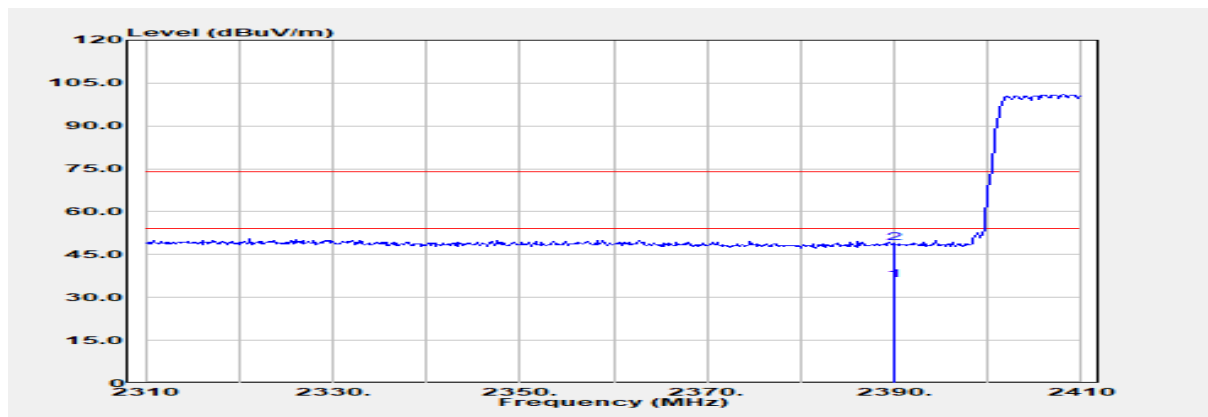

Freq. MHz	Detector Mode PK/QP/AV	Spectrum Reading Level dB $\mu$ V	Factor dB	Actual FS dB $\mu$ V/m	Limit @3m dB $\mu$ V/m	Margin dB
2390.000	Average	30.96	5.18	36.14	54.00	-17.86
2390.000	Peak	43.74	5.18	48.92	74.00	-25.08

Unless otherwise stated the results shown in this test report refer only to the sample(s) tested and such sample(s) are retained for 90 days only.

除非另有說明，此報告結果僅對測試之樣品負責，同時此樣品僅保留90天。本報告未經本公司書面許可，不可部份複製。

This document is issued by the Company subject to its General Conditions of Service printed overleaf, available on request or accessible at <http://www.sgs.com.tw/Terms-and-Conditions> and for electronic format documents, subject to Terms and Conditions for Electronic Documents at <http://www.sgs.com.tw/Terms-and-Conditions>. Attention is drawn to the limitation of liability, indemnification and jurisdiction issues defined therein. Any holder of this document is advised that information contained hereon reflects the Company's findings at the time of its intervention only and within the limits of Client's instructions, if any. The Company's sole responsibility is to its Client and this document does not exonerate parties to a transaction from exercising all their rights and obligations under the transaction documents. This document cannot be reproduced except in full, without prior written approval of the Company. Any unauthorized alteration, forgery or falsification of the content or appearance of this document is unlawful and offenders may be prosecuted to the fullest extent of the law.

Report Number :E2/2021/70052  
 Operation Mode :BT EDR Hopping  
 Test Frequency :2402 MHz  
 Test Mode :BE CH LOW  
 EUT Pol :E2 Plane

Test Site :SAC C  
 Test Date :2021-08-04  
 Temp./Humi. :24.9/52  
 Antenna Pol. :Horizontal  
 Engineer :Enzo Chang

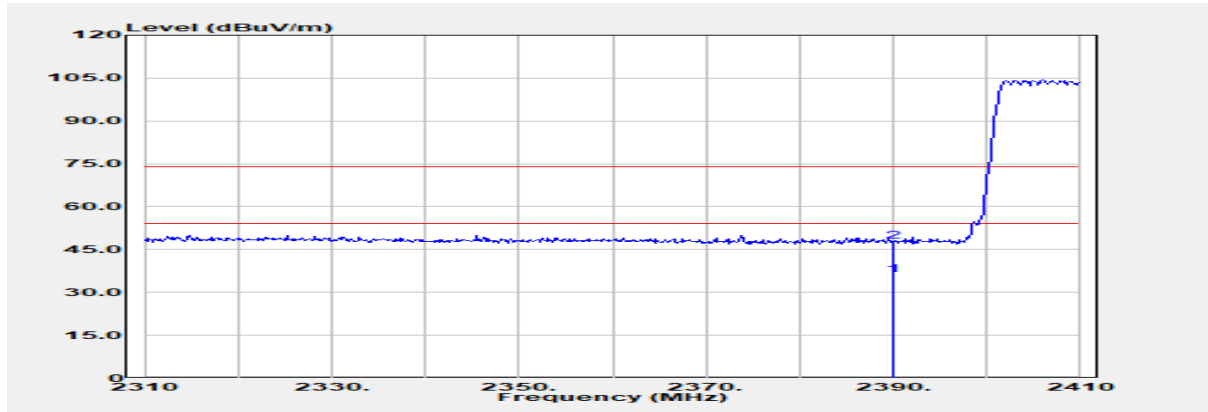

Freq. MHz	Detector Mode PK/QP/AV	Spectrum Reading Level dB $\mu$ V	Factor dB	Actual FS dB $\mu$ V/m	Limit @3m dB $\mu$ V/m	Margin dB
2390.000	Average	31.01	5.18	36.19	54.00	-17.81
2390.000	Peak	42.52	5.18	47.70	74.00	-26.30

Unless otherwise stated the results shown in this test report refer only to the sample(s) tested and such sample(s) are retained for 90 days only.

除非另有說明，此報告結果僅對測試之樣品負責，同時此樣品僅保留90天。本報告未經本公司書面許可，不可部份複製。

This document is issued by the Company subject to its General Conditions of Service printed overleaf, available on request or accessible at <http://www.sgs.com.tw/Terms-and-Conditions> and for electronic format documents, subject to Terms and Conditions for Electronic Documents at <http://www.sgs.com.tw/Terms-and-Conditions>. Attention is drawn to the limitation of liability, indemnification and jurisdiction issues defined therein. Any holder of this document is advised that information contained hereon reflects the Company's findings at the time of its intervention only and within the limits of Client's instructions, if any. The Company's sole responsibility is to its Client and this document does not exonerate parties to a transaction from exercising all their rights and obligations under the transaction documents. This document cannot be reproduced except in full, without prior written approval of the Company. Any unauthorized alteration, forgery or falsification of the content or appearance of this document is unlawful and offenders may be prosecuted to the fullest extent of the law.

Report Number :E2/2021/70052  
 Operation Mode :BT EDR Hopping  
 Test Frequency :2480 MHz  
 Test Mode :BE CH HIGH  
 EUT Pol :E2 Plane

Test Site :SAC C  
 Test Date :2021-08-04  
 Temp./Humi. :24.9/52  
 Antenna Pol. :Vertical  
 Engineer :Enzo Chang

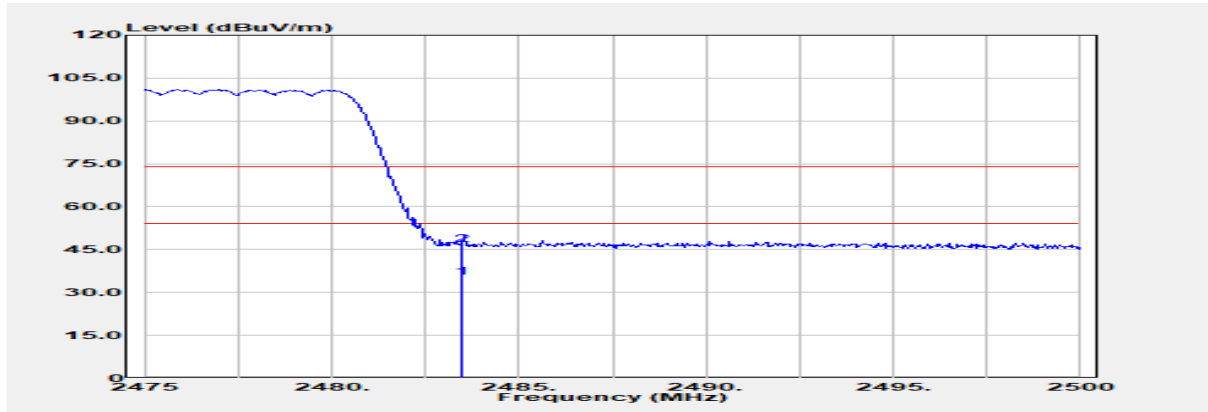

Freq. MHz	Detector Mode PK/QP/AV	Spectrum Reading Level dB $\mu$ V	Factor dB	Actual FS dB $\mu$ V/m	Limit @3m dB $\mu$ V/m	Margin dB
2483.500	Average	31.12	4.04	35.16	54.00	-18.84
2483.500	Peak	42.59	4.04	46.63	74.00	-27.37

Unless otherwise stated the results shown in this test report refer only to the sample(s) tested and such sample(s) are retained for 90 days only.

除非另有說明，此報告結果僅對測試之樣品負責，同時此樣品僅保留90天。本報告未經本公司書面許可，不可部份複製。

This document is issued by the Company subject to its General Conditions of Service printed overleaf, available on request or accessible at <http://www.sgs.com.tw/Terms-and-Conditions> and for electronic format documents, subject to Terms and Conditions for Electronic Documents at <http://www.sgs.com.tw/Terms-and-Conditions>. Attention is drawn to the limitation of liability, indemnification and jurisdiction issues defined therein. Any holder of this document is advised that information contained hereon reflects the Company's findings at the time of its intervention only and within the limits of Client's instructions, if any. The Company's sole responsibility is to its Client and this document does not exonerate parties to a transaction from exercising all their rights and obligations under the transaction documents. This document cannot be reproduced except in full, without prior written approval of the Company. Any unauthorized alteration, forgery or falsification of the content or appearance of this document is unlawful and offenders may be prosecuted to the fullest extent of the law.

Report Number :E2/2021/70052  
 Operation Mode :BT EDR Hopping  
 Test Frequency :2480 MHz  
 Test Mode :BE CH HIGH  
 EUT Pol :E2 Plane

Test Site :SAC C  
 Test Date :2021-08-04  
 Temp./Humi. :24.9/52  
 Antenna Pol. :Horizontal  
 Engineer :Enzo Chang

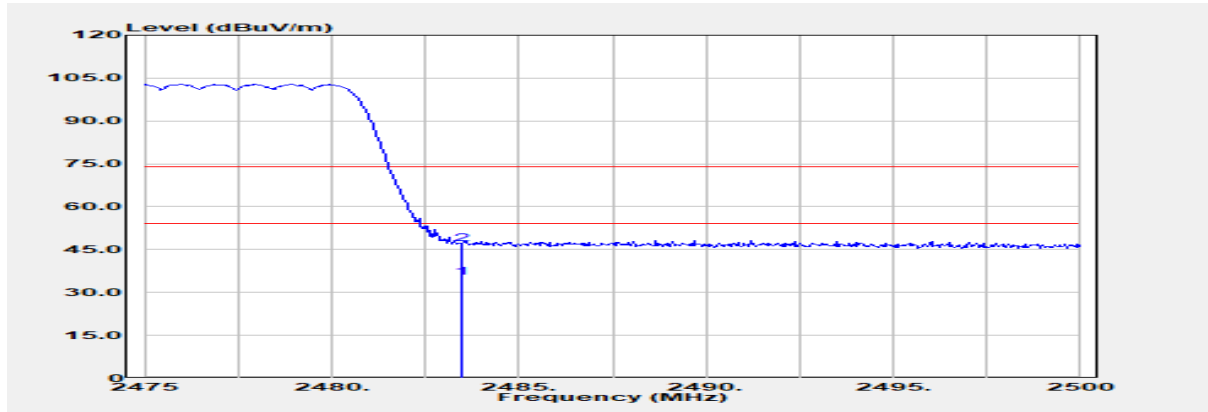

Freq. MHz	Detector Mode PK/QP/AV	Spectrum Reading Level dBμV	Factor dB	Actual FS dBμV/m	Limit @3m dBμV/m	Margin dB
2483.500	Average	31.16	4.04	35.20	54.00	-18.80
2483.500	Peak	42.89	4.04	46.92	74.00	-27.08

Unless otherwise stated the results shown in this test report refer only to the sample(s) tested and such sample(s) are retained for 90 days only.

除非另有說明，此報告結果僅對測試之樣品負責，同時此樣品僅保留90天。本報告未經本公司書面許可，不可部份複製。

This document is issued by the Company subject to its General Conditions of Service printed overleaf, available on request or accessible at <http://www.sgs.com.tw/Terms-and-Conditions> and for electronic format documents, subject to Terms and Conditions for Electronic Documents at <http://www.sgs.com.tw/Terms-and-Conditions>. Attention is drawn to the limitation of liability, indemnification and jurisdiction issues defined therein. Any holder of this document is advised that information contained hereon reflects the Company's findings at the time of its intervention only and within the limits of Client's instructions, if any. The Company's sole responsibility is to its Client and this document does not exonerate parties to a transaction from exercising all their rights and obligations under the transaction documents. This document cannot be reproduced except in full, without prior written approval of the Company. Any unauthorized alteration, forgery or falsification of the content or appearance of this document is unlawful and offenders may be prosecuted to the fullest extent of the law.



### 10.7.2 Radiated Spurious Emission

Report Number :E2/2021/70052

Test Site :SAC C

Operation Mode :BT EDR

Test Date :2021-08-05

Test Frequency :2441 MHz

Temp./Humi. :24.5/61

Test Mode :TX CH MID

Antenna Pol. :VERTICAL

EUT Pol :E2 Plane

Engineer :Enzo Chang

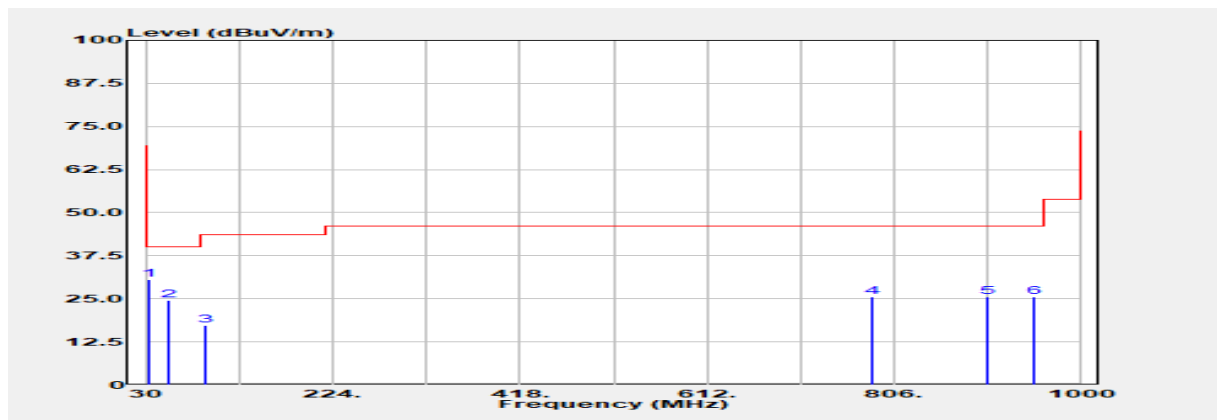

Freq. MHz	Detector Mode PK/QP/AV	Spectrum Reading Level dB $\mu$ V	Factor dB	Actual FS dB $\mu$ V/m	Limit @3m dB $\mu$ V/m	Margin dB
34.663	Peak	39.54	-8.86	30.68	40.00	-9.32
53.317	Peak	46.62	-22.16	24.46	40.00	-15.54
92.179	Peak	38.41	-21.00	17.41	43.50	-26.09
783.926	Peak	32.56	-6.93	25.63	46.00	-20.37
902.067	Peak	31.62	-6.18	25.45	46.00	-20.55
951.811	Peak	30.69	-5.22	25.47	46.00	-20.53

Unless otherwise stated the results shown in this test report refer only to the sample(s) tested and such sample(s) are retained for 90 days only.

除非另有說明，此報告結果僅對測試之樣品負責，同時此樣品僅保留90天。本報告未經本公司書面許可，不可部份複製。

This document is issued by the Company subject to its General Conditions of Service printed overleaf, available on request or accessible at <http://www.sgs.com.tw/Terms-and-Conditions> and for electronic format documents, subject to Terms and Conditions for Electronic Documents at <http://www.sgs.com.tw/Terms-and-Conditions>. Attention is drawn to the limitation of liability, indemnification and jurisdiction issues defined therein. Any holder of this document is advised that information contained hereon reflects the Company's findings at the time of its intervention only and within the limits of Client's instructions, if any. The Company's sole responsibility is to its Client and this document does not exonerate parties to a transaction from exercising all their rights and obligations under the transaction documents. This document cannot be reproduced except in full, without prior written approval of the Company. Any unauthorized alteration, forgery or falsification of the content or appearance of this document is unlawful and offenders may be prosecuted to the fullest extent of the law.

Report Number :E2/2021/70052  
 Operation Mode :BT EDR  
 Test Frequency :2441 MHz  
 Test Mode :TX CH MID  
 EUT Pol :E2 Plane

Test Site :SAC C  
 Test Date :2021-08-05  
 Temp./Humi. :24.5/61  
 Antenna Pol. :HORIZONTAL  
 Engineer :Enzo Chang

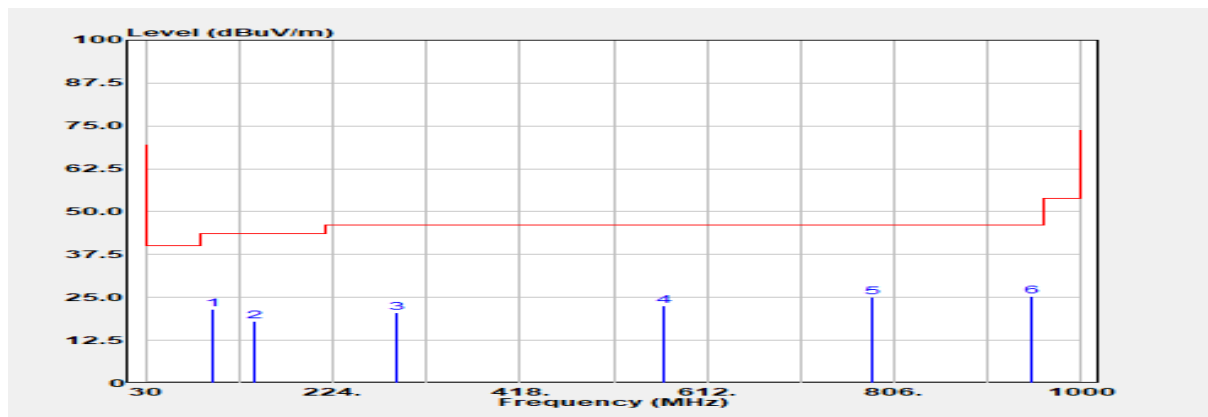

Freq. MHz	Detector Mode PK/QP/AV	Spectrum Reading Level dB $\mu$ V	Factor dB	Actual FS dB $\mu$ V/m	Limit @3m dB $\mu$ V/m	Margin dB
99.952	Peak	41.36	-19.87	21.49	43.50	-22.01
143.478	Peak	35.62	-17.62	18.00	43.50	-25.50
291.154	Peak	36.14	-15.50	20.64	46.00	-25.36
567.853	Peak	31.56	-8.99	22.57	46.00	-23.43
783.926	Peak	31.93	-6.93	25.00	46.00	-21.00
948.702	Peak	30.69	-5.30	25.38	46.00	-20.62

Unless otherwise stated the results shown in this test report refer only to the sample(s) tested and such sample(s) are retained for 90 days only.

除非另有說明，此報告結果僅對測試之樣品負責，同時此樣品僅保留90天。本報告未經本公司書面許可，不可部份複製。

This document is issued by the Company subject to its General Conditions of Service printed overleaf, available on request or accessible at <http://www.sgs.com.tw/Terms-and-Conditions> and for electronic format documents, subject to Terms and Conditions for Electronic Documents at <http://www.sgs.com.tw/Terms-and-Conditions>. Attention is drawn to the limitation of liability, indemnification and jurisdiction issues defined therein. Any holder of this document is advised that information contained hereon reflects the Company's findings at the time of its intervention only and within the limits of Client's instructions, if any. The Company's sole responsibility is to its Client and this document does not exonerate parties to a transaction from exercising all their rights and obligations under the transaction documents. This document cannot be reproduced except in full, without prior written approval of the Company. Any unauthorized alteration, forgery or falsification of the content or appearance of this document is unlawful and offenders may be prosecuted to the fullest extent of the law.

Report Number :E2/2021/70052  
 Operation Mode :BT BR  
 Test Frequency :2402 MHz  
 Test Mode :TX CH LOW  
 EUT Pol :E2 Plane

Test Site :SAC C  
 Test Date :2021-08-04  
 Temp./Humi. :24.7/55  
 Antenna Pol. :Vertical  
 Engineer :Enzo Chang

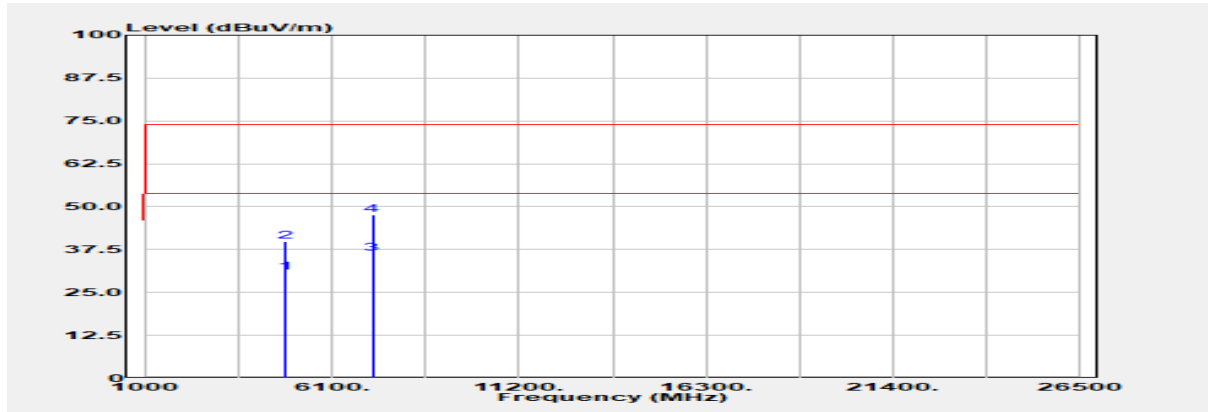

Freq. MHz	Detector Mode PK/QP/AV	Spectrum Reading Level dB $\mu$ V	Factor dB	Actual FS dB $\mu$ V/m	Limit @3m dB $\mu$ V/m	Margin dB
4804.000	Average	20.02	10.87	30.89	54.00	-23.11
4804.000	Peak	29.02	10.87	39.89	74.00	-34.11
7206.000	Average	19.14	17.27	36.41	54.00	-17.59
7206.000	Peak	30.35	17.27	47.62	74.00	-26.38

Unless otherwise stated the results shown in this test report refer only to the sample(s) tested and such sample(s) are retained for 90 days only.

除非另有說明，此報告結果僅對測試之樣品負責，同時此樣品僅保留90天。本報告未經本公司書面許可，不可部份複製。

This document is issued by the Company subject to its General Conditions of Service printed overleaf, available on request or accessible at <http://www.sgs.com.tw/Terms-and-Conditions> and for electronic format documents, subject to Terms and Conditions for Electronic Documents at <http://www.sgs.com.tw/Terms-and-Conditions>. Attention is drawn to the limitation of liability, indemnification and jurisdiction issues defined therein. Any holder of this document is advised that information contained hereon reflects the Company's findings at the time of its intervention only and within the limits of Client's instructions, if any. The Company's sole responsibility is to its Client and this document does not exonerate parties to a transaction from exercising all their rights and obligations under the transaction documents. This document cannot be reproduced except in full, without prior written approval of the Company. Any unauthorized alteration, forgery or falsification of the content or appearance of this document is unlawful and offenders may be prosecuted to the fullest extent of the law.

Report Number :E2/2021/70052  
 Operation Mode :BT BR  
 Test Frequency :2402 MHz  
 Test Mode :TX CH LOW  
 EUT Pol :E2 Plane

Test Site :SAC C  
 Test Date :2021-08-04  
 Temp./Humi. :24.7/55  
 Antenna Pol. :Horizontal  
 Engineer :Enzo Chang

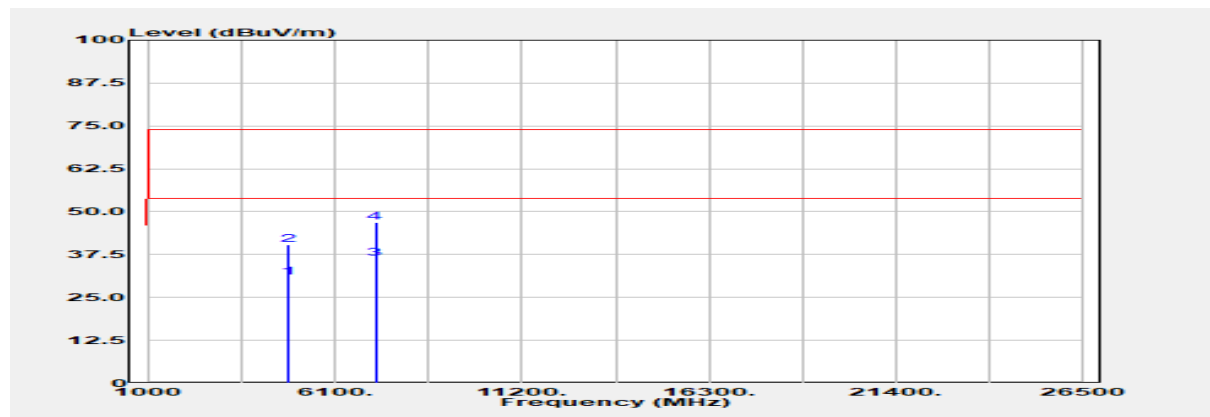

Freq. MHz	Detector Mode PK/QP/AV	Spectrum Reading Level dB $\mu$ V	Factor dB	Actual FS dB $\mu$ V/m	Limit @3m dB $\mu$ V/m	Margin dB
4804.000	Average	19.98	10.87	30.85	54.00	-23.15
4804.000	Peak	29.40	10.87	40.28	74.00	-33.72
7206.000	Average	19.12	17.27	36.39	54.00	-17.61
7206.000	Peak	29.49	17.27	46.76	74.00	-27.24

Unless otherwise stated the results shown in this test report refer only to the sample(s) tested and such sample(s) are retained for 90 days only.

除非另有說明，此報告結果僅對測試之樣品負責，同時此樣品僅保留90天。本報告未經本公司書面許可，不可部份複製。

This document is issued by the Company subject to its General Conditions of Service printed overleaf, available on request or accessible at <http://www.sgs.com.tw/Terms-and-Conditions> and for electronic format documents, subject to Terms and Conditions for Electronic Documents at <http://www.sgs.com.tw/Terms-and-Conditions>. Attention is drawn to the limitation of liability, indemnification and jurisdiction issues defined therein. Any holder of this document is advised that information contained hereon reflects the Company's findings at the time of its intervention only and within the limits of Client's instructions, if any. The Company's sole responsibility is to its Client and this document does not exonerate parties to a transaction from exercising all their rights and obligations under the transaction documents. This document cannot be reproduced except in full, without prior written approval of the Company. Any unauthorized alteration, forgery or falsification of the content or appearance of this document is unlawful and offenders may be prosecuted to the fullest extent of the law.

Report Number :E2/2021/70052  
 Operation Mode :BT BR  
 Test Frequency :2441 MHz  
 Test Mode :TX CH MID  
 EUT Pol :E2 Plane

Test Site :SAC C  
 Test Date :2021-08-04  
 Temp./Humi. :24.7/55  
 Antenna Pol. :Vertical  
 Engineer :Enzo Chang

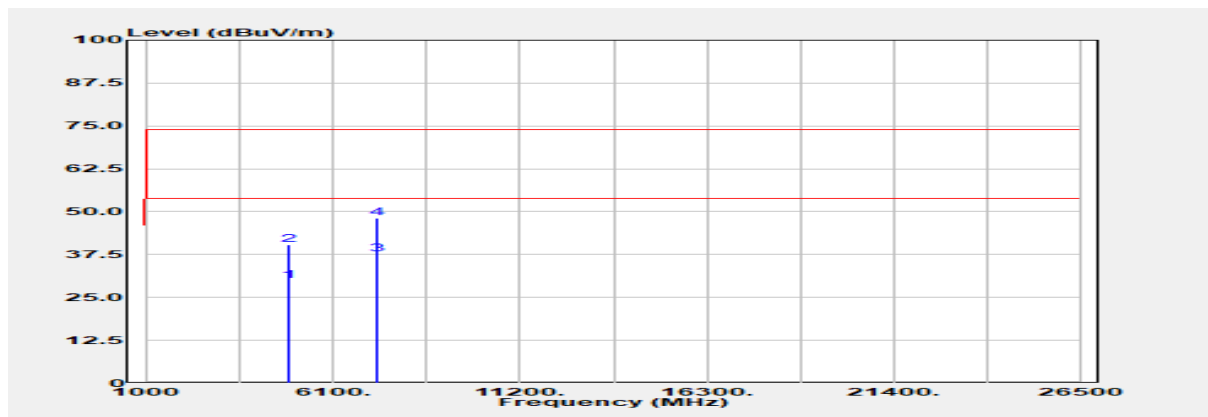

Freq. MHz	Detector Mode PK/QP/AV	Spectrum Reading Level dB $\mu$ V	Factor dB	Actual FS dB $\mu$ V/m	Limit @3m dB $\mu$ V/m	Margin dB
4882.000	Average	19.73	10.12	29.85	54.00	-24.15
4882.000	Peak	30.27	10.12	40.39	74.00	-33.61
7323.000	Average	19.14	18.49	37.63	54.00	-16.37
7323.000	Peak	29.63	18.49	48.12	74.00	-25.88

Unless otherwise stated the results shown in this test report refer only to the sample(s) tested and such sample(s) are retained for 90 days only.

除非另有說明，此報告結果僅對測試之樣品負責，同時此樣品僅保留90天。本報告未經本公司書面許可，不可部份複製。

This document is issued by the Company subject to its General Conditions of Service printed overleaf, available on request or accessible at <http://www.sgs.com.tw/Terms-and-Conditions> and for electronic format documents, subject to Terms and Conditions for Electronic Documents at <http://www.sgs.com.tw/Terms-and-Conditions>. Attention is drawn to the limitation of liability, indemnification and jurisdiction issues defined therein. Any holder of this document is advised that information contained hereon reflects the Company's findings at the time of its intervention only and within the limits of Client's instructions, if any. The Company's sole responsibility is to its Client and this document does not exonerate parties to a transaction from exercising all their rights and obligations under the transaction documents. This document cannot be reproduced except in full, without prior written approval of the Company. Any unauthorized alteration, forgery or falsification of the content or appearance of this document is unlawful and offenders may be prosecuted to the fullest extent of the law.

Report Number :E2/2021/70052  
 Operation Mode :BT BR  
 Test Frequency :2441 MHz  
 Test Mode :TX CH MID  
 EUT Pol :E2 Plane

Test Site :SAC C  
 Test Date :2021-08-04  
 Temp./Humi. :24.7/55  
 Antenna Pol. :Horizontal  
 Engineer :Enzo Chang

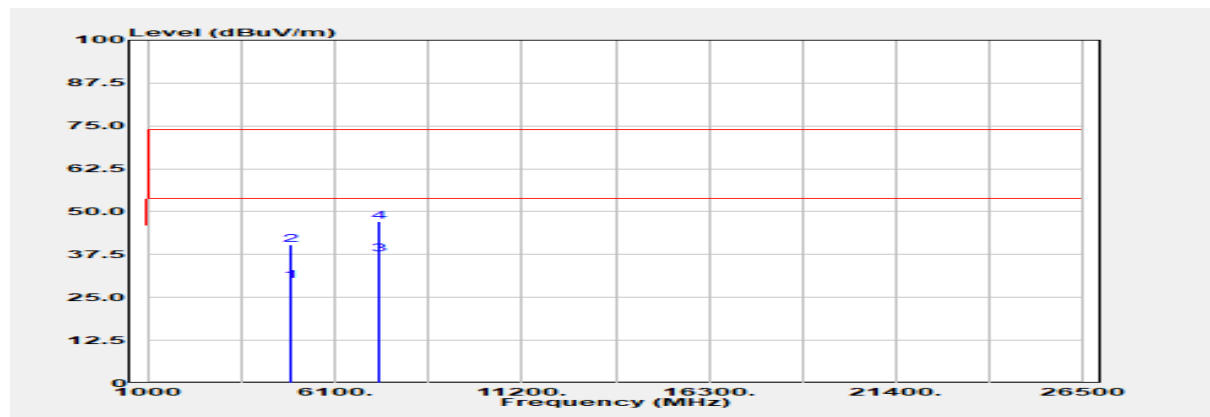

Freq. MHz	Detector Mode PK/QP/AV	Spectrum Reading Level dB $\mu$ V	Factor dB	Actual FS dB $\mu$ V/m	Limit @3m dB $\mu$ V/m	Margin dB
4882.000	Average	19.72	10.12	29.84	54.00	-24.16
4882.000	Peak	30.27	10.12	40.39	74.00	-33.61
7323.000	Average	19.12	18.49	37.61	54.00	-16.39
7323.000	Peak	28.57	18.49	47.06	74.00	-26.94

Unless otherwise stated the results shown in this test report refer only to the sample(s) tested and such sample(s) are retained for 90 days only.

除非另有說明，此報告結果僅對測試之樣品負責，同時此樣品僅保留90天。本報告未經本公司書面許可，不可部份複製。

This document is issued by the Company subject to its General Conditions of Service printed overleaf, available on request or accessible at <http://www.sgs.com.tw/Terms-and-Conditions> and for electronic format documents, subject to Terms and Conditions for Electronic Documents at <http://www.sgs.com.tw/Terms-and-Conditions>. Attention is drawn to the limitation of liability, indemnification and jurisdiction issues defined therein. Any holder of this document is advised that information contained hereon reflects the Company's findings at the time of its intervention only and within the limits of Client's instructions, if any. The Company's sole responsibility is to its Client and this document does not exonerate parties to a transaction from exercising all their rights and obligations under the transaction documents. This document cannot be reproduced except in full, without prior written approval of the Company. Any unauthorized alteration, forgery or falsification of the content or appearance of this document is unlawful and offenders may be prosecuted to the fullest extent of the law.

Report Number :E2/2021/70052  
 Operation Mode :BT BR  
 Test Frequency :2480 MHz  
 Test Mode :TX CH HIGH  
 EUT Pol :E2 Plane

Test Site :SAC C  
 Test Date :2021-08-04  
 Temp./Humi. :24.7/55  
 Antenna Pol. :Vertical  
 Engineer :Enzo Chang

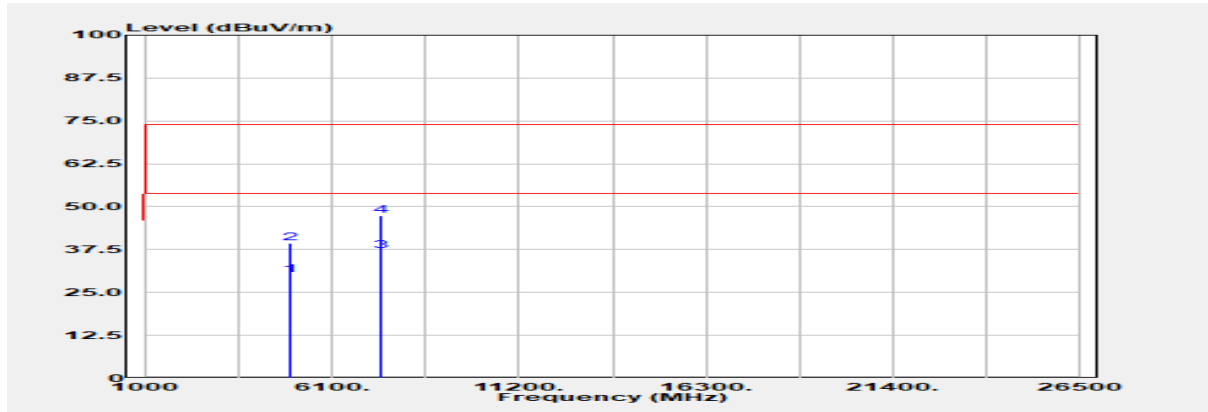

Freq. MHz	Detector Mode PK/QP/AV	Spectrum Reading Level dBμV	Factor dB	Actual FS dBμV/m	Limit @3m dBμV/m	Margin dB
4960.000	Average	19.75	10.20	29.95	54.00	-24.05
4960.000	Peak	29.05	10.20	39.25	74.00	-34.75
7440.000	Average	19.17	17.86	37.03	54.00	-16.97
7440.000	Peak	29.55	17.86	47.41	74.00	-26.59

Unless otherwise stated the results shown in this test report refer only to the sample(s) tested and such sample(s) are retained for 90 days only.

除非另有說明，此報告結果僅對測試之樣品負責，同時此樣品僅保留90天。本報告未經本公司書面許可，不可部份複製。

This document is issued by the Company subject to its General Conditions of Service printed overleaf, available on request or accessible at <http://www.sgs.com.tw/Terms-and-Conditions> and for electronic format documents, subject to Terms and Conditions for Electronic Documents at <http://www.sgs.com.tw/Terms-and-Conditions>. Attention is drawn to the limitation of liability, indemnification and jurisdiction issues defined therein. Any holder of this document is advised that information contained hereon reflects the Company's findings at the time of its intervention only and within the limits of Client's instructions, if any. The Company's sole responsibility is to its Client and this document does not exonerate parties to a transaction from exercising all their rights and obligations under the transaction documents. This document cannot be reproduced except in full, without prior written approval of the Company. Any unauthorized alteration, forgery or falsification of the content or appearance of this document is unlawful and offenders may be prosecuted to the fullest extent of the law.

Report Number :E2/2021/70052  
 Operation Mode :BT BR  
 Test Frequency :2480 MHz  
 Test Mode :TX CH HIGH  
 EUT Pol :E2 Plane

Test Site :SAC C  
 Test Date :2021-08-04  
 Temp./Humi. :24.7/55  
 Antenna Pol. :Horizontal  
 Engineer :Enzo Chang

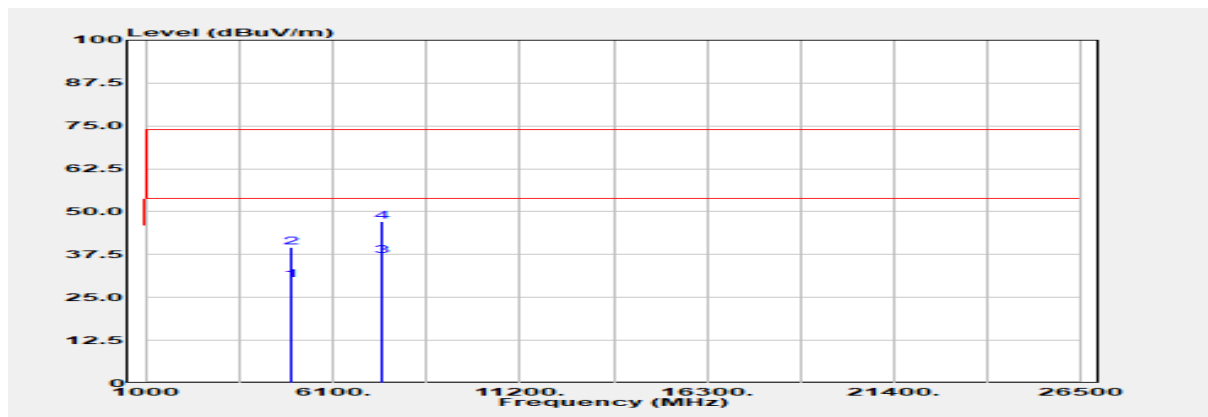

Freq. MHz	Detector Mode PK/QP/AV	Spectrum Reading Level dBμV	Factor dB	Actual FS dBμV/m	Limit @3m dBμV/m	Margin dB
4960.000	Average	19.79	10.20	29.99	54.00	-24.01
4960.000	Peak	29.33	10.20	39.54	74.00	-34.46
7440.000	Average	19.21	17.86	37.07	54.00	-16.93
7440.000	Peak	29.34	17.86	47.20	74.00	-26.80

Unless otherwise stated the results shown in this test report refer only to the sample(s) tested and such sample(s) are retained for 90 days only.

除非另有說明，此報告結果僅對測試之樣品負責，同時此樣品僅保留90天。本報告未經本公司書面許可，不可部份複製。

This document is issued by the Company subject to its General Conditions of Service printed overleaf, available on request or accessible at <http://www.sgs.com.tw/Terms-and-Conditions> and for electronic format documents, subject to Terms and Conditions for Electronic Documents at <http://www.sgs.com.tw/Terms-and-Conditions>. Attention is drawn to the limitation of liability, indemnification and jurisdiction issues defined therein. Any holder of this document is advised that information contained hereon reflects the Company's findings at the time of its intervention only and within the limits of Client's instructions, if any. The Company's sole responsibility is to its Client and this document does not exonerate parties to a transaction from exercising all their rights and obligations under the transaction documents. This document cannot be reproduced except in full, without prior written approval of the Company. Any unauthorized alteration, forgery or falsification of the content or appearance of this document is unlawful and offenders may be prosecuted to the fullest extent of the law.



Report Number :E2/2021/70052  
 Operation Mode :BT EDR  
 Test Frequency :2402 MHz  
 Test Mode :TX CH LOW  
 EUT Pol :E2 Plane

Test Site :SAC C  
 Test Date :2021-08-04  
 Temp./Humi. :24.2/58  
 Antenna Pol. :Vertical  
 Engineer :Enzo Chang

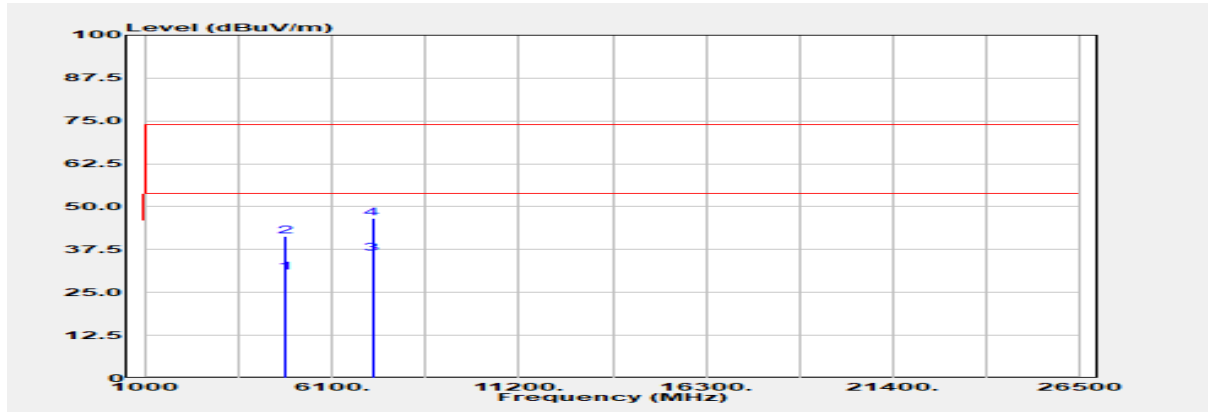

Freq. MHz	Detector Mode PK/QP/AV	Spectrum Reading Level dB $\mu$ V	Factor dB	Actual FS dB $\mu$ V/m	Limit @3m dB $\mu$ V/m	Margin dB
4804.000	Average	20.02	10.87	30.89	54.00	-23.11
4804.000	Peak	30.36	10.87	41.24	74.00	-32.76
7206.000	Average	19.12	17.27	36.39	54.00	-17.61
7206.000	Peak	29.31	17.27	46.59	74.00	-27.41

Unless otherwise stated the results shown in this test report refer only to the sample(s) tested and such sample(s) are retained for 90 days only.

除非另有說明，此報告結果僅對測試之樣品負責，同時此樣品僅保留90天。本報告未經本公司書面許可，不可部份複製。

This document is issued by the Company subject to its General Conditions of Service printed overleaf, available on request or accessible at <http://www.sgs.com.tw/Terms-and-Conditions> and for electronic format documents, subject to Terms and Conditions for Electronic Documents at <http://www.sgs.com.tw/Terms-and-Conditions>. Attention is drawn to the limitation of liability, indemnification and jurisdiction issues defined therein. Any holder of this document is advised that information contained hereon reflects the Company's findings at the time of its intervention only and within the limits of Client's instructions, if any. The Company's sole responsibility is to its Client and this document does not exonerate parties to a transaction from exercising all their rights and obligations under the transaction documents. This document cannot be reproduced except in full, without prior written approval of the Company. Any unauthorized alteration, forgery or falsification of the content or appearance of this document is unlawful and offenders may be prosecuted to the fullest extent of the law.

Report Number :E2/2021/70052  
 Operation Mode :BT EDR  
 Test Frequency :2402 MHz  
 Test Mode :TX CH LOW  
 EUT Pol :E2 Plane

Test Site :SAC C  
 Test Date :2021-08-04  
 Temp./Humi. :24.2/58  
 Antenna Pol. :Horizontal  
 Engineer :Enzo Chang

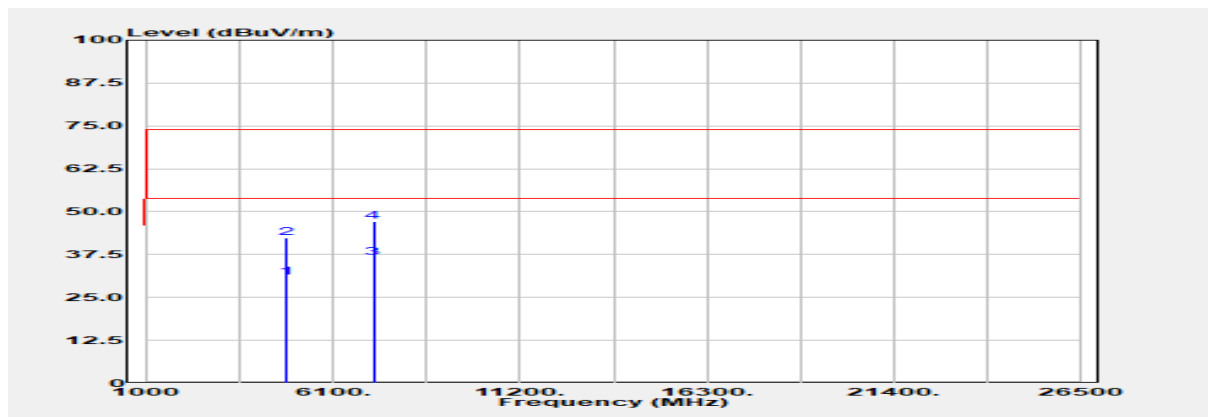

Freq. MHz	Detector Mode PK/QP/AV	Spectrum Reading Level dB $\mu$ V	Factor dB	Actual FS dB $\mu$ V/m	Limit @3m dB $\mu$ V/m	Margin dB
4804.000	Average	20.02	10.87	30.89	54.00	-23.11
4804.000	Peak	31.50	10.87	42.37	74.00	-31.63
7206.000	Average	19.25	17.27	36.52	54.00	-17.48
7206.000	Peak	29.77	17.27	47.04	74.00	-26.96

Unless otherwise stated the results shown in this test report refer only to the sample(s) tested and such sample(s) are retained for 90 days only.

除非另有說明，此報告結果僅對測試之樣品負責，同時此樣品僅保留90天。本報告未經本公司書面許可，不可部份複製。

This document is issued by the Company subject to its General Conditions of Service printed overleaf, available on request or accessible at <http://www.sgs.com.tw/Terms-and-Conditions> and for electronic format documents, subject to Terms and Conditions for Electronic Documents at <http://www.sgs.com.tw/Terms-and-Conditions>. Attention is drawn to the limitation of liability, indemnification and jurisdiction issues defined therein. Any holder of this document is advised that information contained hereon reflects the Company's findings at the time of its intervention only and within the limits of Client's instructions, if any. The Company's sole responsibility is to its Client and this document does not exonerate parties to a transaction from exercising all their rights and obligations under the transaction documents. This document cannot be reproduced except in full, without prior written approval of the Company. Any unauthorized alteration, forgery or falsification of the content or appearance of this document is unlawful and offenders may be prosecuted to the fullest extent of the law.

Report Number :E2/2021/70052  
 Operation Mode :BT EDR  
 Test Frequency :2441 MHz  
 Test Mode :TX CH MID  
 EUT Pol :E2 Plane

Test Site :SAC C  
 Test Date :2021-08-04  
 Temp./Humi. :24.2/58  
 Antenna Pol. :Vertical  
 Engineer :Enzo Chang

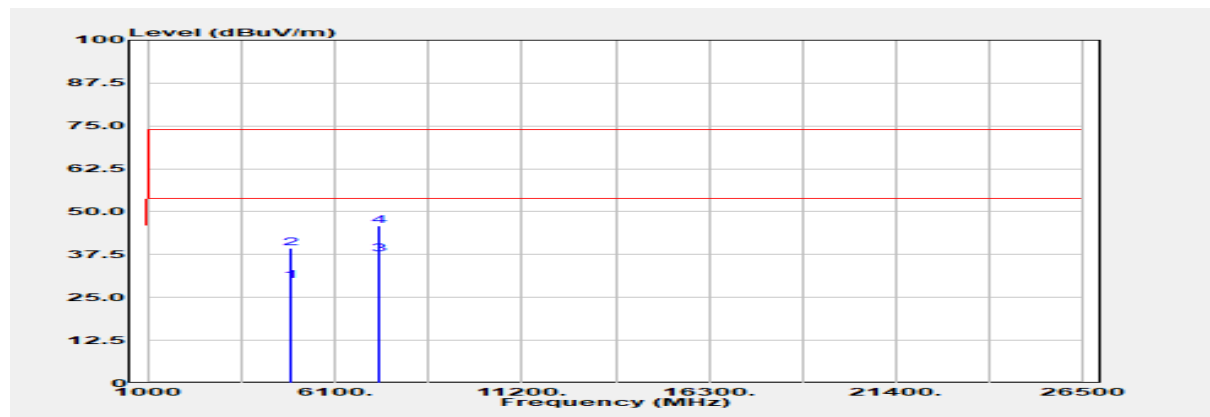

Freq. MHz	Detector Mode PK/QP/AV	Spectrum Reading Level dB $\mu$ V	Factor dB	Actual FS dB $\mu$ V/m	Limit @3m dB $\mu$ V/m	Margin dB
4882.000	Average	19.72	10.12	29.84	54.00	-24.16
4882.000	Peak	29.32	10.12	39.44	74.00	-34.56
7323.000	Average	19.13	18.49	37.62	54.00	-16.38
7323.000	Peak	27.48	18.49	45.96	74.00	-28.04

Unless otherwise stated the results shown in this test report refer only to the sample(s) tested and such sample(s) are retained for 90 days only.

除非另有說明，此報告結果僅對測試之樣品負責，同時此樣品僅保留90天。本報告未經本公司書面許可，不可部份複製。

This document is issued by the Company subject to its General Conditions of Service printed overleaf, available on request or accessible at <http://www.sgs.com.tw/Terms-and-Conditions> and for electronic format documents, subject to Terms and Conditions for Electronic Documents at <http://www.sgs.com.tw/Terms-and-Conditions>. Attention is drawn to the limitation of liability, indemnification and jurisdiction issues defined therein. Any holder of this document is advised that information contained hereon reflects the Company's findings at the time of its intervention only and within the limits of Client's instructions, if any. The Company's sole responsibility is to its Client and this document does not exonerate parties to a transaction from exercising all their rights and obligations under the transaction documents. This document cannot be reproduced except in full, without prior written approval of the Company. Any unauthorized alteration, forgery or falsification of the content or appearance of this document is unlawful and offenders may be prosecuted to the fullest extent of the law.

Report Number :E2/2021/70052  
 Operation Mode :BT EDR  
 Test Frequency :2441 MHz  
 Test Mode :TX CH MID  
 EUT Pol :E2 Plane

Test Site :SAC C  
 Test Date :2021-08-04  
 Temp./Humi. :24.2/58  
 Antenna Pol. :Horizontal  
 Engineer :Enzo Chang

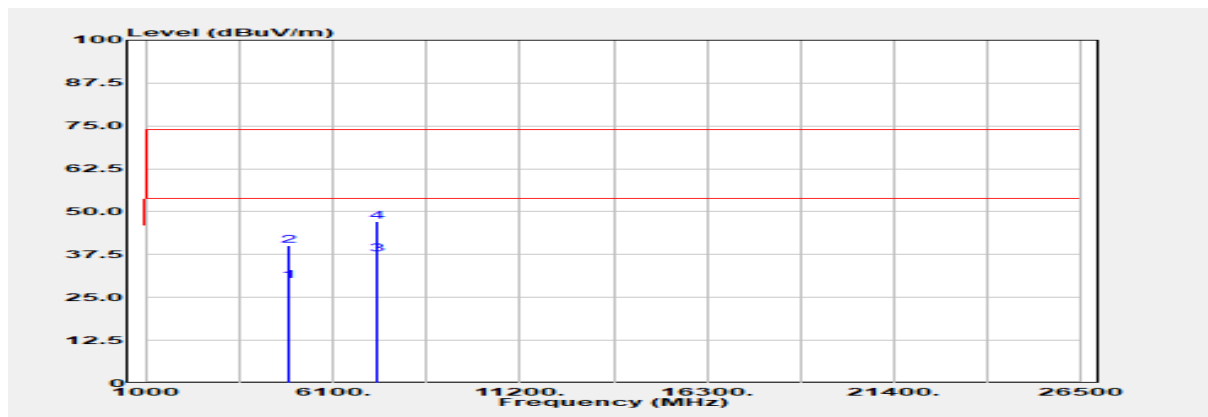

Freq. MHz	Detector Mode PK/QP/AV	Spectrum Reading Level dB $\mu$ V	Factor dB	Actual FS dB $\mu$ V/m	Limit @3m dB $\mu$ V/m	Margin dB
4882.000	Average	19.64	10.12	29.76	54.00	-24.24
4882.000	Peak	29.95	10.12	40.06	74.00	-33.94
7323.000	Average	19.16	18.49	37.65	54.00	-16.35
7323.000	Peak	28.67	18.49	47.16	74.00	-26.84

Unless otherwise stated the results shown in this test report refer only to the sample(s) tested and such sample(s) are retained for 90 days only.

除非另有說明，此報告結果僅對測試之樣品負責，同時此樣品僅保留90天。本報告未經本公司書面許可，不可部份複製。

This document is issued by the Company subject to its General Conditions of Service printed overleaf, available on request or accessible at <http://www.sgs.com.tw/Terms-and-Conditions> and for electronic format documents, subject to Terms and Conditions for Electronic Documents at <http://www.sgs.com.tw/Terms-and-Conditions>. Attention is drawn to the limitation of liability, indemnification and jurisdiction issues defined therein. Any holder of this document is advised that information contained hereon reflects the Company's findings at the time of its intervention only and within the limits of Client's instructions, if any. The Company's sole responsibility is to its Client and this document does not exonerate parties to a transaction from exercising all their rights and obligations under the transaction documents. This document cannot be reproduced except in full, without prior written approval of the Company. Any unauthorized alteration, forgery or falsification of the content or appearance of this document is unlawful and offenders may be prosecuted to the fullest extent of the law.

Report Number :E2/2021/70052  
 Operation Mode :BT EDR  
 Test Frequency :2480 MHz  
 Test Mode :TX CH HIGH  
 EUT Pol :E2 Plane

Test Site :SAC C  
 Test Date :2021-08-04  
 Temp./Humi. :24.2/58  
 Antenna Pol. :Vertical  
 Engineer :Enzo Chang

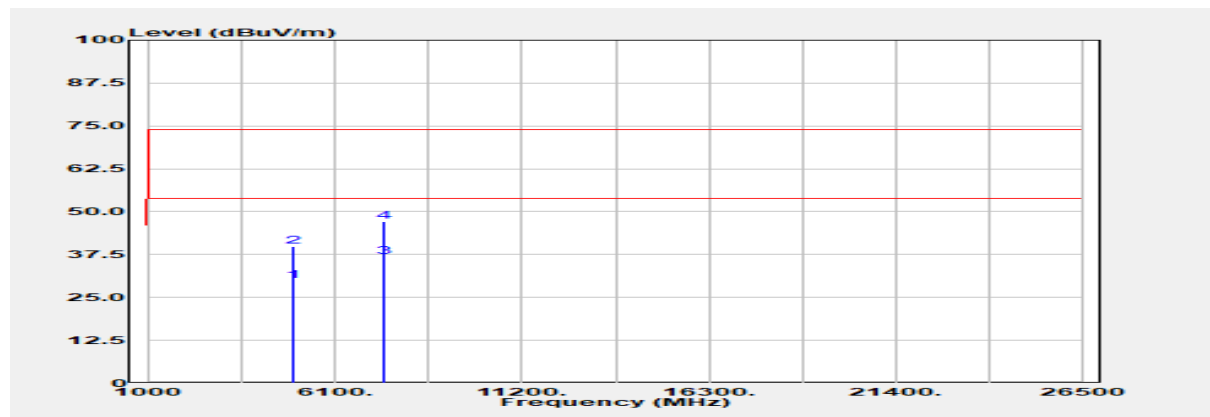

Freq. MHz	Detector Mode PK/QP/AV	Spectrum Reading Level dB $\mu$ V	Factor dB	Actual FS dB $\mu$ V/m	Limit @3m dB $\mu$ V/m	Margin dB
4960.000	Average	19.58	10.20	29.78	54.00	-24.22
4960.000	Peak	29.77	10.20	39.97	74.00	-34.03
7440.000	Average	19.04	17.86	36.90	54.00	-17.10
7440.000	Peak	29.16	17.86	47.02	74.00	-26.98

Unless otherwise stated the results shown in this test report refer only to the sample(s) tested and such sample(s) are retained for 90 days only.

除非另有說明，此報告結果僅對測試之樣品負責，同時此樣品僅保留90天。本報告未經本公司書面許可，不可部份複製。

This document is issued by the Company subject to its General Conditions of Service printed overleaf, available on request or accessible at <http://www.sgs.com.tw/Terms-and-Conditions> and for electronic format documents, subject to Terms and Conditions for Electronic Documents at <http://www.sgs.com.tw/Terms-and-Conditions>. Attention is drawn to the limitation of liability, indemnification and jurisdiction issues defined therein. Any holder of this document is advised that information contained hereon reflects the Company's findings at the time of its intervention only and within the limits of Client's instructions, if any. The Company's sole responsibility is to its Client and this document does not exonerate parties to a transaction from exercising all their rights and obligations under the transaction documents. This document cannot be reproduced except in full, without prior written approval of the Company. Any unauthorized alteration, forgery or falsification of the content or appearance of this document is unlawful and offenders may be prosecuted to the fullest extent of the law.

Report Number :E2/2021/70052  
 Operation Mode :BT EDR  
 Test Frequency :2480 MHz  
 Test Mode :TX CH HIGH  
 EUT Pol :E2 Plane

Test Site :SAC C  
 Test Date :2021-08-04  
 Temp./Humi. :24.2/58  
 Antenna Pol. :Horizontal  
 Engineer :Enzo Chang

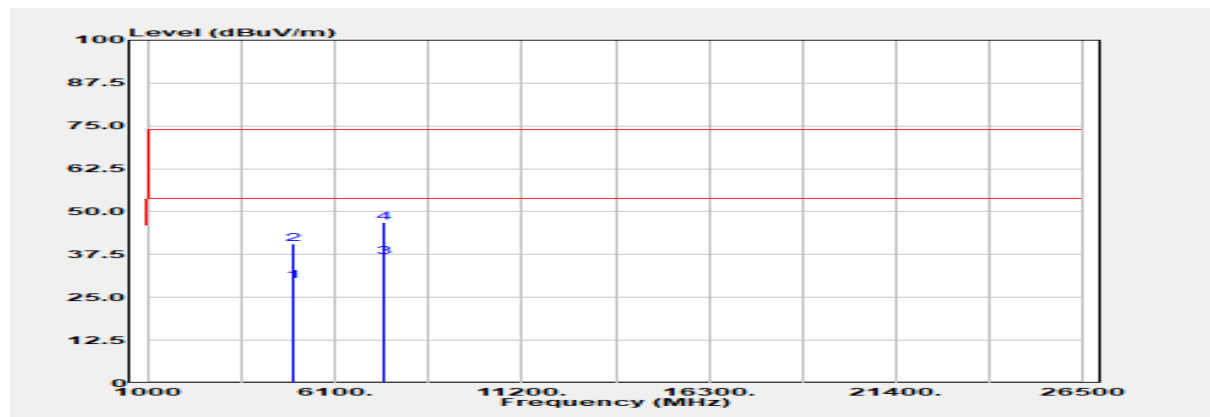

Freq. MHz	Detector Mode PK/QP/AV	Spectrum Reading Level dBμV	Factor dB	Actual FS dBμV/m	Limit @3m dBμV/m	Margin dB
4960.000	Average	19.52	10.20	29.72	54.00	-24.28
4960.000	Peak	30.48	10.20	40.68	74.00	-33.32
7440.000	Average	19.02	17.86	36.88	54.00	-17.12
7440.000	Peak	28.97	17.86	46.83	74.00	-27.17

Unless otherwise stated the results shown in this test report refer only to the sample(s) tested and such sample(s) are retained for 90 days only.

除非另有說明，此報告結果僅對測試之樣品負責，同時此樣品僅保留90天。本報告未經本公司書面許可，不可部份複製。

This document is issued by the Company subject to its General Conditions of Service printed overleaf, available on request or accessible at <http://www.sgs.com.tw/Terms-and-Conditions> and for electronic format documents, subject to Terms and Conditions for Electronic Documents at <http://www.sgs.com.tw/Terms-and-Conditions>. Attention is drawn to the limitation of liability, indemnification and jurisdiction issues defined therein. Any holder of this document is advised that information contained hereon reflects the Company's findings at the time of its intervention only and within the limits of Client's instructions, if any. The Company's sole responsibility is to its Client and this document does not exonerate parties to a transaction from exercising all their rights and obligations under the transaction documents. This document cannot be reproduced except in full, without prior written approval of the Company. Any unauthorized alteration, forgery or falsification of the content or appearance of this document is unlawful and offenders may be prosecuted to the fullest extent of the law.

## 11 FREQUENCY SEPARATION

### 11.1 Standard Applicable

Frequency hopping systems shall have hopping channel carrier frequencies separated by minimum of 25 kHz or the  $2/3 \times 20\text{dB}$  bandwidth of the hopping channel, whichever is greater.

### 11.2 Measurement Equipment Used

Conducted Emission Test Site: Conducted D					
EQUIPMENT TYPE	MFR	MODEL NUMBER	SERIAL NUMBER	LAST CAL.	CAL DUE.
Spectrum Analyzer	KEYSIGHT	N9010B	MY59071574	06/25/2021	06/25/2022
Bluetooth Test Set	R&S	CBT	101140	05/09/2021	05/08/2022
Power Meter	Anritsu	ML2496A	1804002	04/14/2021	04/13/2022
Power Sensor	Anritsu	MA2411B	1726105	04/14/2021	04/13/2022
Power Sensor	Anritsu	MA2411B	1726106	04/14/2021	04/13/2022
Attenuator	Marvelous	WATT-218FS-10	RF16	11/19/2020	11/18/2021
DC Block	PASTERNAK	PE8210	RF158	11/19/2020	11/18/2021
Splitter	Marvelous Microwave	MVE8576	RF257	11/19/2020	11/18/2021
Coaxial Cables	Woken	00100A1F2 A196C	RF57	11/19/2020	11/18/2021
Coaxial Cables	Woken	00100A1F2 A196C	RF64	11/19/2020	11/18/2021
Test Software	SGS	Radio Test Software	V21.07.28	N/A	N/A

### 11.3 Test Set-up

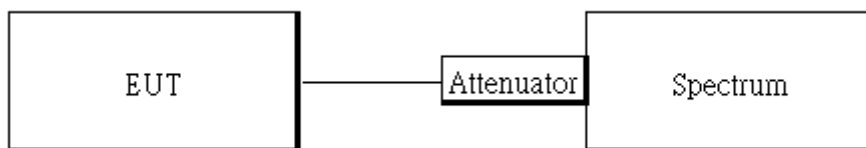

Unless otherwise stated the results shown in this test report refer only to the sample(s) tested and such sample(s) are retained for 90 days only.

除非另有說明，此報告結果僅對測試之樣品負責，同時此樣品僅保留90天。本報告未經本公司書面許可，不可部份複製。

This document is issued by the Company subject to its General Conditions of Service printed overleaf, available on request or accessible at <http://www.sgs.com.tw/Terms-and-Conditions> and for electronic format documents, subject to Terms and Conditions for Electronic Documents at <http://www.sgs.com.tw/Terms-and-Conditions>. Attention is drawn to the limitation of liability, indemnification and jurisdiction issues defined therein. Any holder of this document is advised that information contained hereon reflects the Company's findings at the time of its intervention only and within the limits of Client's instructions, if any. The Company's sole responsibility is to its Client and this document does not exonerate parties to a transaction from exercising all their rights and obligations under the transaction documents. This document cannot be reproduced except in full, without prior written approval of the Company. Any unauthorized alteration, forgery or falsification of the content or appearance of this document is unlawful and offenders may be prosecuted to the fullest extent of the law.

### 11.4 Measurement Procedure

1. Place the EUT on the table and set it in transmitting mode.
2. The testing follows ANSI C63.10:2013.
3. Remove the antenna from the EUT and then connect a low loss RF cable from the antenna port to the spectrum analyzer.
4. Set center frequency of spectrum analyzer = middle of hopping channel.
5. Set the spectrum analyzer as RBW, VBW=100 kHz, Adjust Span to 5MHz, Sweep = auto.
6. Max hold. Mark 3 Peaks of hopping channel and record the 3 peaks frequency.

### 11.5 Measurement Result

Channel separation (MHz)	Limit	Result
1	$\geq 25$ kHz or 2/3 times 20dB bandwidth	PASS

Unless otherwise stated the results shown in this test report refer only to the sample(s) tested and such sample(s) are retained for 90 days only.

除非另有說明，此報告結果僅對測試之樣品負責，同時此樣品僅保留90天。本報告未經本公司書面許可，不可部份複製。

This document is issued by the Company subject to its General Conditions of Service printed overleaf, available on request or accessible at <http://www.sgs.com.tw/Terms-and-Conditions> and for electronic format documents, subject to Terms and Conditions for Electronic Documents at <http://www.sgs.com.tw/Terms-and-Conditions>. Attention is drawn to the limitation of liability, indemnification and jurisdiction issues defined therein. Any holder of this document is advised that information contained hereon reflects the Company's findings at the time of its intervention only and within the limits of Client's instructions, if any. The Company's sole responsibility is to its Client and this document does not exonerate parties to a transaction from exercising all their rights and obligations under the transaction documents. This document cannot be reproduced except in full, without prior written approval of the Company. Any unauthorized alteration, forgery or falsification of the content or appearance of this document is unlawful and offenders may be prosecuted to the fullest extent of the law.



GFSK\_1M\_DH5\_CH0CH1CH2



π/4DQPSK\_2M\_DH5\_CH0CH1CH2



GFSK\_1M\_DH5\_CH38CH39CH40



π/4DQPSK\_2M\_DH5\_CH38CH39CH40

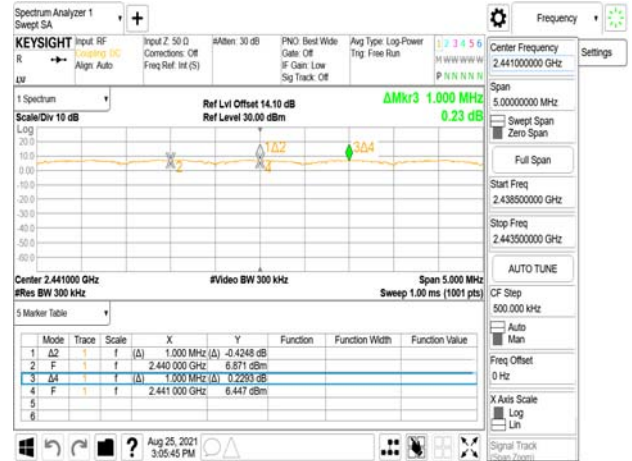

GFSK\_1M\_DH5\_CH76CH77CH78



π/4DQPSK\_2M\_DH5\_CH76CH77CH78

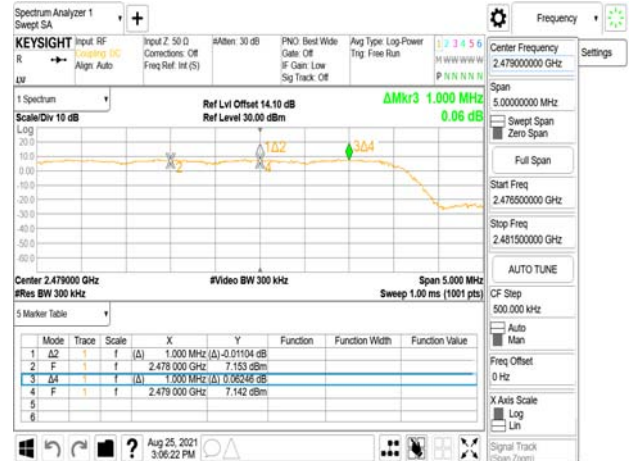

Unless otherwise stated the results shown in this test report refer only to the sample(s) tested and such sample(s) are retained for 90 days only.

除非另有說明，此報告結果僅對測試之樣品負責，同時此樣品僅保留90天。本報告未經本公司書面許可，不可部份複製。

This document is issued by the Company subject to its General Conditions of Service printed overleaf, available on request or accessible at <http://www.sgs.com.tw/Terms-and-Conditions> and for electronic format documents, subject to Terms and Conditions for Electronic Documents at <http://www.sgs.com.tw/Terms-and-Conditions>. Attention is drawn to the limitation of liability, indemnification and jurisdiction issues defined therein. Any holder of this document is advised that information contained hereon reflects the Company's findings at the time of its intervention only and within the limits of Client's instructions, if any. The Company's sole responsibility is to its Client and this document does not exonerate parties to a transaction from exercising all their rights and obligations under the transaction documents. This document cannot be reproduced except in full, without prior written approval of the Company. Any unauthorized alteration, forgery or falsification of the content or appearance of this document is unlawful and offenders may be prosecuted to the fullest extent of the law.

8DPSK\_3M\_DH5\_CH0CH1CH2

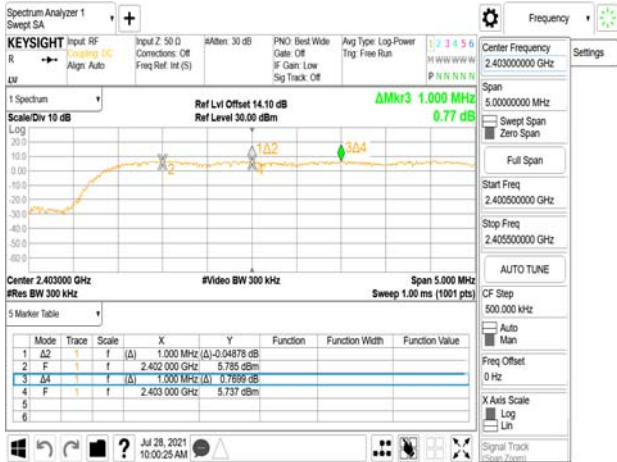

8DPSK\_3M\_DH5\_CH38CH39CH40



8DPSK\_3M\_DH5\_CH76CH77CH78



Unless otherwise stated the results shown in this test report refer only to the sample(s) tested and such sample(s) are retained for 90 days only.

除非另有說明，此報告結果僅對測試之樣品負責，同時此樣品僅保留90天。本報告未經本公司書面許可，不可部份複製。

This document is issued by the Company subject to its General Conditions of Service printed overleaf, available on request or accessible at <http://www.sgs.com.tw/Terms-and-Conditions> and for electronic format documents, subject to Terms and Conditions for Electronic Documents at <http://www.sgs.com.tw/Terms-and-Conditions>. Attention is drawn to the limitation of liability, indemnification and jurisdiction issues defined therein. Any holder of this document is advised that information contained hereon reflects the Company's findings at the time of its intervention only and within the limits of Client's instructions, if any. The Company's sole responsibility is to its Client and this document does not exonerate parties to a transaction from exercising all their rights and obligations under the transaction documents. This document cannot be reproduced except in full, without prior written approval of the Company. Any unauthorized alteration, forgery or falsification of the content or appearance of this document is unlawful and offenders may be prosecuted to the fullest extent of the law.

## 12 NUMBER OF HOPPING FREQUENCY

### 12.1 Standard Applicable

Frequency hopping systems operating in the 2400MHz-2483.5 MHz bands shall use at least 15 hopping frequencies.

### 12.2 Measurement Equipment Used

Conducted Emission Test Site: Conducted D					
EQUIPMENT TYPE	MFR	MODEL NUMBER	SERIAL NUMBER	LAST CAL.	CAL DUE.
Spectrum Analyzer	KEYSIGHT	N9010B	MY59071574	06/25/2021	06/25/2022
Bluetooth Test Set	R&S	CBT	101140	05/09/2021	05/08/2022
Power Meter	Anritsu	ML2496A	1804002	04/14/2021	04/13/2022
Power Sensor	Anritsu	MA2411B	1726105	04/14/2021	04/13/2022
Power Sensor	Anritsu	MA2411B	1726106	04/14/2021	04/13/2022
Attenuator	Marvelous	WATT-218FS-10	RF16	11/19/2020	11/18/2021
DC Block	PASTERNAK	PE8210	RF158	11/19/2020	11/18/2021
Splitter	Marvelous Microwave	MVE8576	RF257	11/19/2020	11/18/2021
Coaxial Cables	Woken	00100A1F2 A196C	RF57	11/19/2020	11/18/2021
Coaxial Cables	Woken	00100A1F2 A196C	RF64	11/19/2020	11/18/2021
Test Software	SGS	Radio Test Software	V21.07.28	N/A	N/A

### 12.3 Test Set-up

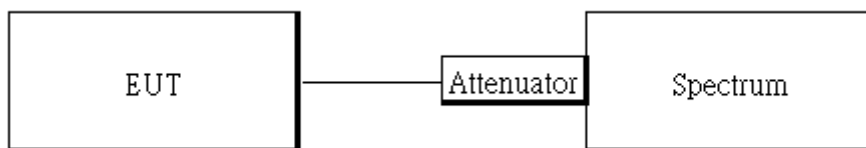

### 12.4 Measurement Procedure

1. Place the EUT on the table and set it in transmitting mode.
2. The testing follows ANSI C63.10:2013.
3. Remove the antenna from the EUT and then connect a low loss RF cable from the antenna port to the spectrum analyzer.
4. Set spectrum analyzer Start=2400MHz, Stop = 2483.5MHz, Sweep = auto.
5. Set the spectrum analyzer as RBW=430kHz, VBW=1.5MHz., Detector = Peak

Unless otherwise stated the results shown in this test report refer only to the sample(s) tested and such sample(s) are retained for 90 days only.

除非另有說明，此報告結果僅對測試之樣品負責，同時此樣品僅保留90天。本報告未經本公司書面許可，不可部份複製。

This document is issued by the Company subject to its General Conditions of Service printed overleaf, available on request or accessible at <http://www.sgs.com.tw/Terms-and-Conditions> and for electronic format documents, subject to Terms and Conditions for Electronic Documents at <http://www.sgs.com.tw/Terms-and-Conditions>. Attention is drawn to the limitation of liability, indemnification and jurisdiction issues defined therein. Any holder of this document is advised that information contained hereon reflects the Company's findings at the time of its intervention only and within the limits of Client's instructions, if any. The Company's sole responsibility is to its Client and this document does not exonerate parties to a transaction from exercising all their rights and obligations under the transaction documents. This document cannot be reproduced except in full, without prior written approval of the Company. Any unauthorized alteration, forgery or falsification of the content or appearance of this document is unlawful and offenders may be prosecuted to the fullest extent of the law.

6. Max hold, view and count how many channel in the band.

## 12.5 Measurement Result

### Tabular Data of Total Channel Number

	<i>Channel Number</i>	<i>Limit</i>
<b>2.4 GHz – 2.441 GHz</b>	<b>40</b>	<b>&gt;15</b>
<b>2.441 GHz – 2.4835 GHz</b>	<b>39</b>	
<b>2.4 GHz ~2.4835 GHz</b>	<b>(40+39) = 79</b>	

Unless otherwise stated the results shown in this test report refer only to the sample(s) tested and such sample(s) are retained for 90 days only.

除非另有說明，此報告結果僅對測試之樣品負責，同時此樣品僅保留90天。本報告未經本公司書面許可，不可部份複製。

This document is issued by the Company subject to its General Conditions of Service printed overleaf, available on request or accessible at <http://www.sgs.com.tw/Terms-and-Conditions> and for electronic format documents, subject to Terms and Conditions for Electronic Documents at <http://www.sgs.com.tw/Terms-and-Conditions>. Attention is drawn to the limitation of liability, indemnification and jurisdiction issues defined therein. Any holder of this document is advised that information contained hereon reflects the Company's findings at the time of its intervention only and within the limits of Client's instructions, if any. The Company's sole responsibility is to its Client and this document does not exonerate parties to a transaction from exercising all their rights and obligations under the transaction documents. This document cannot be reproduced except in full, without prior written approval of the Company. Any unauthorized alteration, forgery or falsification of the content or appearance of this document is unlawful and offenders may be prosecuted to the fullest extent of the law.

GFSK\_1M\_DH5\_2400-2441



8DPSK\_3M\_DH5\_2400-2441



GFSK\_1M\_DH5\_2441-2480



8DPSK\_3M\_DH5\_2441-2480

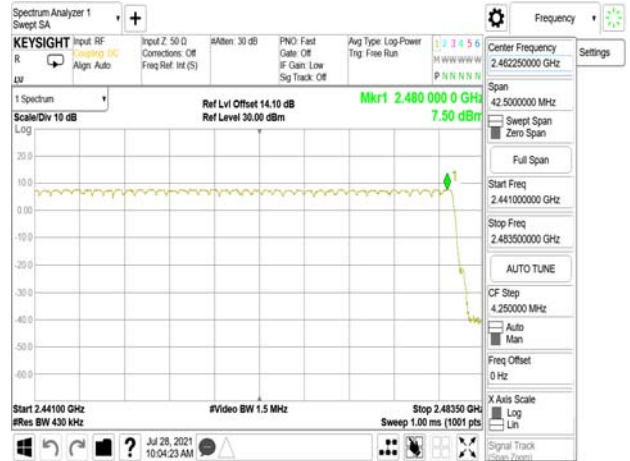

Unless otherwise stated the results shown in this test report refer only to the sample(s) tested and such sample(s) are retained for 90 days only.

除非另有說明，此報告結果僅對測試之樣品負責，同時此樣品僅保留90天。本報告未經本公司書面許可，不可部份複製。

This document is issued by the Company subject to its General Conditions of Service printed overleaf, available on request or accessible at <http://www.sgs.com.tw/Terms-and-Conditions> and for electronic format documents, subject to Terms and Conditions for Electronic Documents at <http://www.sgs.com.tw/Terms-and-Conditions>. Attention is drawn to the limitation of liability, indemnification and jurisdiction issues defined therein. Any holder of this document is advised that information contained hereon reflects the Company's findings at the time of its intervention only and within the limits of Client's instructions, if any. The Company's sole responsibility is to its Client and this document does not exonerate parties to a transaction from exercising all their rights and obligations under the transaction documents. This document cannot be reproduced except in full, without prior written approval of the Company. Any unauthorized alteration, forgery or falsification of the content or appearance of this document is unlawful and offenders may be prosecuted to the fullest extent of the law.

### 13 TIME OF OCCUPANCY (DWELL TIME)

#### 13.1 Standard Applicable

Frequency hopping systems operating in the 2400MHz-2483.5MHz. The average time of occupancy on any frequency shall not greater than 0.4 s within period of 0.4 seconds multiplied by the number of hopping channel employed.

#### 13.2 Measurement Equipment Used

Conducted Emission Test Site: Conducted D					
EQUIPMENT TYPE	MFR	MODEL NUMBER	SERIAL NUMBER	LAST CAL.	CAL DUE.
Spectrum Analyzer	KEYSIGHT	N9010B	MY59071574	06/25/2021	06/25/2022
Bluetooth Test Set	R&S	CBT	101140	05/09/2021	05/08/2022
Power Meter	Anritsu	ML2496A	1804002	04/14/2021	04/13/2022
Power Sensor	Anritsu	MA2411B	1726105	04/14/2021	04/13/2022
Power Sensor	Anritsu	MA2411B	1726106	04/14/2021	04/13/2022
Attenuator	Marvelous	WATT-218FS-10	RF16	11/19/2020	11/18/2021
DC Block	PASTERNAK	PE8210	RF158	11/19/2020	11/18/2021
Splitter	Marvelous Microwave	MVE8576	RF257	11/19/2020	11/18/2021
Coaxial Cables	Woken	00100A1F2 A196C	RF57	11/19/2020	11/18/2021
Coaxial Cables	Woken	00100A1F2 A196C	RF64	11/19/2020	11/18/2021
Test Software	SGS	Radio Test Software	V21.07.28	N/A	N/A

#### 13.3 Test Set-up

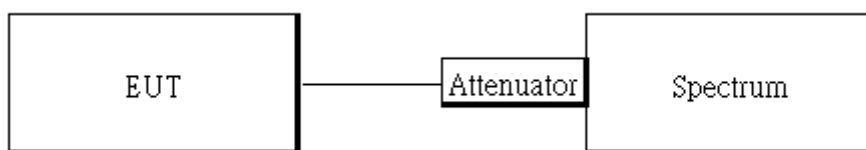

Unless otherwise stated the results shown in this test report refer only to the sample(s) tested and such sample(s) are retained for 90 days only.

除非另有說明，此報告結果僅對測試之樣品負責，同時此樣品僅保留90天。本報告未經本公司書面許可，不可部份複製。

This document is issued by the Company subject to its General Conditions of Service printed overleaf, available on request or accessible at <http://www.sgs.com.tw/Terms-and-Conditions> and for electronic format documents, subject to Terms and Conditions for Electronic Documents at <http://www.sgs.com.tw/Terms-and-Conditions>. Attention is drawn to the limitation of liability, indemnification and jurisdiction issues defined therein. Any holder of this document is advised that information contained hereon reflects the Company's findings at the time of its intervention only and within the limits of Client's instructions, if any. The Company's sole responsibility is to its Client and this document does not exonerate parties to a transaction from exercising all their rights and obligations under the transaction documents. This document cannot be reproduced except in full, without prior written approval of the Company. Any unauthorized alteration, forgery or falsification of the content or appearance of this document is unlawful and offenders may be prosecuted to the fullest extent of the law.



### 13.4 Measurement Procedure

1. Place the EUT on the table and set it in transmitting mode.
2. The testing follows ANSI C63.10:2015.
3. Remove the antenna from the EUT and then connect a low loss RF cable from the antenna port to the spectrum analyzer.
4. Set center frequency of spectrum analyzer = operating frequency.
5. Set the spectrum analyzer as RBW, VBW=1MHz, 3MHz, Span = 0Hz , Detector = Peak, Adjust Sweep = 2~8ms.
6. Repeat above procedures until all frequency of the interest measured were complete.

Formula Deduced: time occupancy of one time slot X Hopping rate / total slot in one channel / total channel that hops X period of working channels.

Where, standard hopping rate is 1600 hops/s, slot in one channel for DH1, DH3, and DH5 is 2, 4, and 6, respectively.

DH1 consists of single time slot of the uplink, and one slot of the downlink Total Slot: 2

DH3 consists of three time slot of the uplink, and one slot of the downlink. Total Slot: 4

DH5 consists of five time slot of the uplink, and one slot of the downlink. Total Slot: 6

In AFH mode, hopping rate is 800 hop/s with 6 slots in 20 hopping channels with channel hopping rate (800 / 6 / 20) in Occupancy Time Limit (0.4 \* 20 ) (S), Hop Over Occupancy Time comes to (800 / 6 / 20)\*(0.4 \*20 ) =53.33

Note: the result of the complete test default channel at 1Mbps is recorded on the test report, 2Mbps, and 3Mbps only records the measurement result at middle channel that reveals no much deviation.

Unless otherwise stated the results shown in this test report refer only to the sample(s) tested and such sample(s) are retained for 90 days only.

除非另有說明，此報告結果僅對測試之樣品負責，同時此樣品僅保留90天。本報告未經本公司書面許可，不可部份複製。

This document is issued by the Company subject to its General Conditions of Service printed overleaf, available on request or accessible at <http://www.sgs.com.tw/Terms-and-Conditions> and for electronic format documents, subject to Terms and Conditions for Electronic Documents at <http://www.sgs.com.tw/Terms-and-Conditions>. Attention is drawn to the limitation of liability, indemnification and jurisdiction issues defined therein. Any holder of this document is advised that information contained hereon reflects the Company's findings at the time of its intervention only and within the limits of Client's instructions, if any. The Company's sole responsibility is to its Client and this document does not exonerate parties to a transaction from exercising all their rights and obligations under the transaction documents. This document cannot be reproduced except in full, without prior written approval of the Company. Any unauthorized alteration, forgery or falsification of the content or appearance of this document is unlawful and offenders may be prosecuted to the fullest extent of the law.

### 13.5 Tabular Result of the Measurement

#### GFSK (1Mbps)

Channel	PACKET TYPE	Measurement Result (ms)	Limit (ms)	VBW setting (kHz)
Mid	DH1	123.20	400ms	3.00
	DH3	260.80	400ms	1.00
	DH5	307.20	400ms	1.00

#### $\pi/4$ DQPSK (2Mbps)

Channel	PACKET TYPE	Measurement Result (ms)	Limit (ms)	VBW setting (kHz)
Mid	2DH1	123.20	400ms	3.00
	2DH3	262.40	400ms	1.00
	2DH5	307.20	400ms	1.00

#### 8-DPSK (3Mbps)

Channel	PACKET TYPE	Measurement Result (ms)	Limit (ms)	VBW setting (kHz)
Mid	3DH1	124.80	400ms	3.00
	3DH3	262.40	400ms	1.00
	3DH5	307.20	400ms	1.00

Unless otherwise stated the results shown in this test report refer only to the sample(s) tested and such sample(s) are retained for 90 days only.

除非另有說明，此報告結果僅對測試之樣品負責，同時此樣品僅保留90天。本報告未經本公司書面許可，不可部份複製。

This document is issued by the Company subject to its General Conditions of Service printed overleaf, available on request or accessible at <http://www.sgs.com.tw/Terms-and-Conditions> and for electronic format documents, subject to Terms and Conditions for Electronic Documents at <http://www.sgs.com.tw/Terms-and-Conditions>. Attention is drawn to the limitation of liability, indemnification and jurisdiction issues defined therein. Any holder of this document is advised that information contained hereon reflects the Company's findings at the time of its intervention only and within the limits of Client's instructions, if any. The Company's sole responsibility is to its Client and this document does not exonerate parties to a transaction from exercising all their rights and obligations under the transaction documents. This document cannot be reproduced except in full, without prior written approval of the Company. Any unauthorized alteration, forgery or falsification of the content or appearance of this document is unlawful and offenders may be prosecuted to the fullest extent of the law.



**GFSK (1Mbps):**

CH Mid	DH1 time slot	=	0.385	*	(1600/2/79)	*	31.6	=	123.20	(ms)
	DH3 time slot	=	1.630	*	(1600/4/79)	*	31.6	=	260.80	(ms)
	DH5 time slot	=	2.880	*	(1600/6/79)	*	31.6	=	307.20	(ms)

**$\pi/4$  -DQPSK (2Mbps):**

CH Mid	2DH1 time slot	=	0.385	*	(1600/2/79)	*	31.6	=	123.20	(ms)
	2DH3 time slot	=	1.640	*	(1600/4/79)	*	31.6	=	262.40	(ms)
	2DH5 time slot	=	2.880	*	(1600/6/79)	*	31.6	=	307.20	(ms)

**8-DPSK (3Mbps):**

CH Mid	3DH1 time slot	=	0.390	*	(1600/2/79)	*	31.6	=	124.80	(ms)
	3DH3 time slot	=	1.640	*	(1600/4/79)	*	31.6	=	262.40	(ms)
	3DH5 time slot	=	2.880	*	(1600/6/79)	*	31.6	=	307.20	(ms)

A period time = 0.4 (s) \* 79 = 31.6 (s)

Unless otherwise stated the results shown in this test report refer only to the sample(s) tested and such sample(s) are retained for 90 days only.

除非另有說明，此報告結果僅對測試之樣品負責，同時此樣品僅保留90天。本報告未經本公司書面許可，不可部份複製。

This document is issued by the Company subject to its General Conditions of Service printed overleaf, available on request or accessible at <http://www.sgs.com.tw/Terms-and-Conditions> and for electronic format documents, subject to Terms and Conditions for Electronic Documents at <http://www.sgs.com.tw/Terms-and-Conditions>. Attention is drawn to the limitation of liability, indemnification and jurisdiction issues defined therein. Any holder of this document is advised that information contained hereon reflects the Company's findings at the time of its intervention only and within the limits of Client's instructions, if any. The Company's sole responsibility is to its Client and this document does not exonerate parties to a transaction from exercising all their rights and obligations under the transaction documents. This document cannot be reproduced except in full, without prior written approval of the Company. Any unauthorized alteration, forgery or falsification of the content or appearance of this document is unlawful and offenders may be prosecuted to the fullest extent of the law.

GFSK (1Mbps) for AFH Mode			
Hopping Channel Number	PACKET TYPE	Measurement Result (ms)	Limit (ms)
20	DH5	153.60	400
$\pi/4$ DQPSK (2Mbps) for AFH Mode			
Hopping Channel Number	PACKET TYPE	Measurement Result (ms)	Limit (ms)
20	2DH5	153.60	400
8-DPSK (3Mbps) for AFH Mode			
Hopping Channel Number	PACKET TYPE	Measurement Result (ms)	Limit (ms)
20	3DH5	153.60	400

Unless otherwise stated the results shown in this test report refer only to the sample(s) tested and such sample(s) are retained for 90 days only.

除非另有說明，此報告結果僅對測試之樣品負責，同時此樣品僅保留90天。本報告未經本公司書面許可，不可部份複製。

This document is issued by the Company subject to its General Conditions of Service printed overleaf, available on request or accessible at <http://www.sgs.com.tw/Terms-and-Conditions> and for electronic format documents, subject to Terms and Conditions for Electronic Documents at <http://www.sgs.com.tw/Terms-and-Conditions>. Attention is drawn to the limitation of liability, indemnification and jurisdiction issues defined therein. Any holder of this document is advised that information contained hereon reflects the Company's findings at the time of its intervention only and within the limits of Client's instructions, if any. The Company's sole responsibility is to its Client and this document does not exonerate parties to a transaction from exercising all their rights and obligations under the transaction documents. This document cannot be reproduced except in full, without prior written approval of the Company. Any unauthorized alteration, forgery or falsification of the content or appearance of this document is unlawful and offenders may be prosecuted to the fullest extent of the law.

Dwell Time\_GFSK\_1M\_DH1\_2441MHz

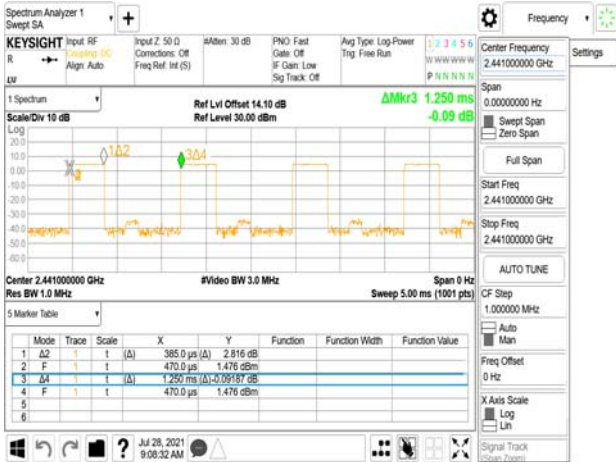

Dwell Time\_π/4DQPSK\_2M\_DH5\_2441MHz



Dwell Time\_GFSK\_1M\_DH3\_2441MHz

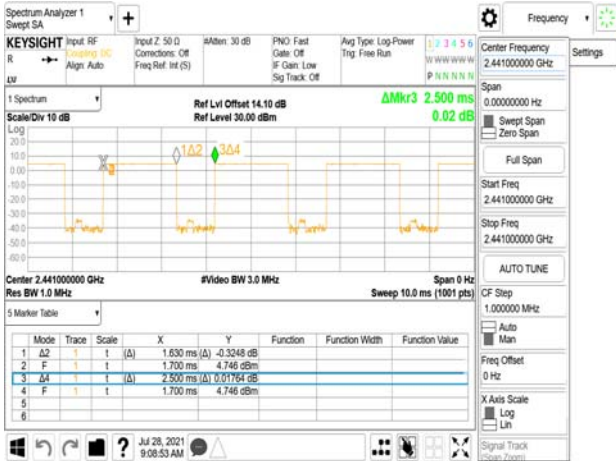

Dwell Time\_π/4DQPSK\_2M\_DH5\_2441MHz



Dwell Time\_GFSK\_1M\_DH5\_2441MHz

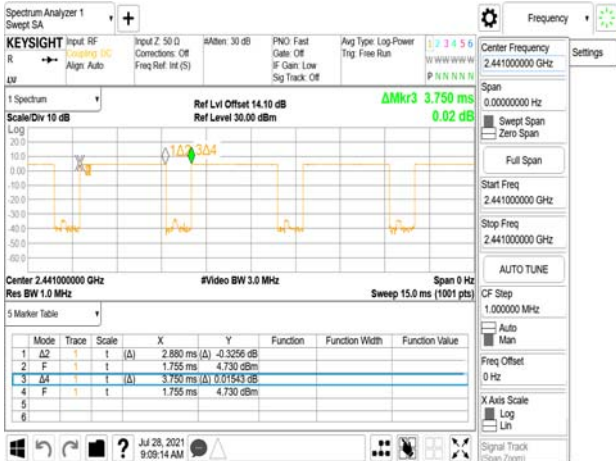

Dwell Time\_π/4DQPSK\_2M\_DH5\_2441MHz



Unless otherwise stated the results shown in this test report refer only to the sample(s) tested and such sample(s) are retained for 90 days only.

除非另有說明，此報告結果僅對測試之樣品負責，同時此樣品僅保留90天。本報告未經本公司書面許可，不可部份複製。

This document is issued by the Company subject to its General Conditions of Service printed overleaf, available on request or accessible at <http://www.sgs.com.tw/Terms-and-Conditions> and for electronic format documents, subject to Terms and Conditions for Electronic Documents at <http://www.sgs.com.tw/Terms-and-Conditions>. Attention is drawn to the limitation of liability, indemnification and jurisdiction issues defined therein. Any holder of this document is advised that information contained hereon reflects the Company's findings at the time of its intervention only and within the limits of Client's instructions, if any. The Company's sole responsibility is to its Client and this document does not exonerate parties to a transaction from exercising all their rights and obligations under the transaction documents. This document cannot be reproduced except in full, without prior written approval of the Company. Any unauthorized alteration, forgery or falsification of the content or appearance of this document is unlawful and offenders may be prosecuted to the fullest extent of the law.

Dwell Time\_8DPSK\_3M\_DH1\_2441MHz

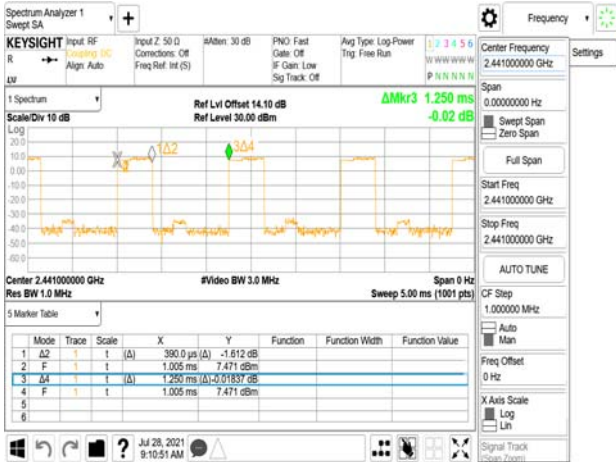

Dwell Time\_8DPSK\_3M\_DH3\_2441MHz



Dwell Time\_8DPSK\_3M\_DH5\_2441MHz



Unless otherwise stated the results shown in this test report refer only to the sample(s) tested and such sample(s) are retained for 90 days only.

除非另有說明，此報告結果僅對測試之樣品負責，同時此樣品僅保留90天。本報告未經本公司書面許可，不可部份複製。

This document is issued by the Company subject to its General Conditions of Service printed overleaf, available on request or accessible at <http://www.sgs.com.tw/Terms-and-Conditions> and for electronic format documents, subject to Terms and Conditions for Electronic Documents at <http://www.sgs.com.tw/Terms-and-Conditions>. Attention is drawn to the limitation of liability, indemnification and jurisdiction issues defined therein. Any holder of this document is advised that information contained hereon reflects the Company's findings at the time of its intervention only and within the limits of Client's instructions, if any. The Company's sole responsibility is to its Client and this document does not exonerate parties to a transaction from exercising all their rights and obligations under the transaction documents. This document cannot be reproduced except in full, without prior written approval of the Company. Any unauthorized alteration, forgery or falsification of the content or appearance of this document is unlawful and offenders may be prosecuted to the fullest extent of the law.

## 14 ANTENNA REQUIREMENT

### 14.1 Standard Applicable

For intentional device, according to §15.203, an intentional radiator shall be designed to ensure that no antenna other than furnished by the responsible party shall be used with the device.

If the transmitting antenna is greater than 6dBi, the power shall be reduced by the same level in dB comparing to gain minus 6dBi.

### 14.2 Antenna Connected Construction

The antenna is designed as permanently attached and no consideration of replacement. Please see EUT photo for details.

*~ End of Report ~*

Unless otherwise stated the results shown in this test report refer only to the sample(s) tested and such sample(s) are retained for 90 days only.

除非另有說明，此報告結果僅對測試之樣品負責，同時此樣品僅保留90天。本報告未經本公司書面許可，不可部份複製。

This document is issued by the Company subject to its General Conditions of Service printed overleaf, available on request or accessible at <http://www.sgs.com.tw/Terms-and-Conditions> and for electronic format documents, subject to Terms and Conditions for Electronic Documents at <http://www.sgs.com.tw/Terms-and-Conditions>. Attention is drawn to the limitation of liability, indemnification and jurisdiction issues defined therein. Any holder of this document is advised that information contained hereon reflects the Company's findings at the time of its intervention only and within the limits of Client's instructions, if any. The Company's sole responsibility is to its Client and this document does not exonerate parties to a transaction from exercising all their rights and obligations under the transaction documents. This document cannot be reproduced except in full, without prior written approval of the Company. Any unauthorized alteration, forgery or falsification of the content or appearance of this document is unlawful and offenders may be prosecuted to the fullest extent of the law.