

Peloton Interactive Inc.

TEST REPORT

REPORT NUMBER
180600460TWN-001

ISSUE DATE

Sep. 11, 2018

PAGES
28

DOCUMENT CONTROL NUMBER

© 2018 INTERTEK



Radio Spectrum TEST REPORT

Applicant:	Peloton Interactive Inc. 125 W 25th St, 11th Floor, New York, NY 10001
Product:	Peloton Console Tablet
Model No.:	PLTN-RB1VO
Brand Name:	Peloton Console
FCC ID:	2AA3N- RB1VO
Test Method/ Standard:	47 CFR FCC Part 15.249 & ANSI C63.10 2013
Test By:	Intertek Testing Services Taiwan Ltd., Hsinchu Laboratory No. 11, Lane 275, Ko-Nan 1 Street, Chia-Tung Li, Shiang-Shan District, Hsinchu City, Taiwan



Prepared and Checked by:

Approved by:

*Durant Wei**Maxy You.*

Durant Wei
Engineer

Maxy You
Engineer

This report is for the exclusive use of Intertek's Client and is provided pursuant to the agreement between Intertek and its Client. Intertek's responsibility and liability are limited to the terms and conditions of the agreement. Intertek assumes no liability to any party, other than to the Client in accordance with the agreement, for any loss, expense or damage occasioned by the use of this report. Only the Client is authorized to permit copying or distribution of this report and then only in its entirety. Any use of the Intertek name or one of its marks for the sale or advertisement of the tested material, product or service must first be approved in writing by Intertek. The observations and test results in this report are relevant only to the sample tested. This report by itself does not imply that the material, product, or service is or has ever been under an Intertek certification program.

Revision History

Report No.	Issue Date	Revision Summary
180600460TWN-001	Sep. 11, 2018	Original report

Table of Contents

Summary of Tests	4
1. General Information	5
1.1 Identification of the EUT	5
1.2 Antenna description	5
1.3 Peripherals equipment	5
2. Test specifications.....	6
2.1 Test standard	6
2.2 Operation mode	6
3. 20dB Bandwidth test	7
3.1 Operating environment	7
3.2 Test setup & procedure	7
3.3 Measured data of modulated bandwidth test results.....	7
4. Radiated emission test FCC 15.249 (C)	9
4.1 Operating environment	9
4.2 Test setup & procedure	9
4.3 Emission limit	11
4.3.1 Fundamental and harmonics emission limits.....	11
4.3.2 General radiated emission limits.....	12
4.4 Radiated spurious emission test data.....	12
4.4.1 Measurement results: frequency range from 9 kHz to 30 MHz.....	12
4.4.2 Measurement results: frequencies equal to or less than 1 GHz	14
4.4.3 Measurement results: frequency above 1GHz.....	16
4.4.4 Measurement results: Fundamental	18
5. Radiated emission on the band edge FCC 15.249(d)	19
5.1 Operating environment	19
5.2 Radiated emission on the band edge test data	19
6. AC Power Line Conducted Emission	22
6.1 Measuring instrument setting.....	22
6.2 Test Procedure	22
6.3 Test Diagram	22
6.4 Limit.....	23
6.5 Operating Environment Condition	23
6.6 Test Results	24
Appendix A: Test equipment list.....	26
Appendix B: Measurement Uncertainty.....	28

Summary of Tests

Test	Reference	Results
20dB Bandwidth	15.215(c)	Pass
Radiated Emission test	15.249(c), 15.209	Pass
Emission on the Band Edge	15.249(d)	Pass
Conducted Emission of AC Power	15.207	Pass
Antenna Requirement	15.203	Pass

1. General Information

1.1 Identification of the EUT

Product:	Peloton Console Tablet
Model No.:	PLTN-RB1VO
Operating Frequency:	2402 MHz, 2440 MHz, 2480 MHz
Channel Number:	3 channels
Access scheme:	GFSK
Rated Power:	DC 12V from adapter
Power Cord:	N/A
Sample receiving date:	Jun. 28, 2018
Sample condition:	Workable
Test Date(s):	Jul. 14, 2018 ~ Jul. 26, 2018

1.2 Antenna description

Antenna Gain : 4.32 dBi

Antenna Type : PCB Antenna

Connector Type : I-PEX

1.3 Peripherals equipment

No.	Model no.	Specification
Adapter	EA10681G-120	I/P: 100-240V~, 2.0A,50-60Hz O/P: 12V, 4.16A

2. Test specifications

2.1 Test standard

The EUT was performed according to the procedures in FCC Part 15 Subpart C Paragraph 15.249 for non-spread spectrum devices.

The test of radiated measurements according to FCC Part15 Section 15.33(a) had been conducted and the field strength of this frequency band were all meet limit requirement, thus we evaluate the EUT pass the specified test.

2.2 Operation mode

TX mode: EUT use 「ANTware II-v.4.1.exe」 entering test mode , and Touchscreen to change different channel.

3. 20dB Bandwidth test

3.1 Operating environment

Temperature:	25	°C
Relative Humidity:	50	%
Atmospheric Pressure:	1008	hPa

3.2 Test setup & procedure

Step 1: The 20dB bandwidth was measured using a 50 ohm spectrum analyzer

Step 2: The span range for the SA display shall be between two times and five times the OBW.

Step 3: The nominal IF filter bandwidth (3 dB RBW) should be approximately 1 % to 5 % of the OBW, unless otherwise specified, depending on the applicable requirement.

Step 4: The test was performed at 1 channel. The maximum 20dB modulation bandwidth is in the following Table.

3.3 Measured data of modulated bandwidth test results

Single TX

Mode	Frequency (MHz)	20dB Occupied Bandwidth (MHz)
ANT+	2402	0.8261
	2440	0.9124
	2480	1.137

Please see the plot below.

20dB Bandwidth @ ANT+ Channel Low



20dB Bandwidth @ ANT+ Channel Mid

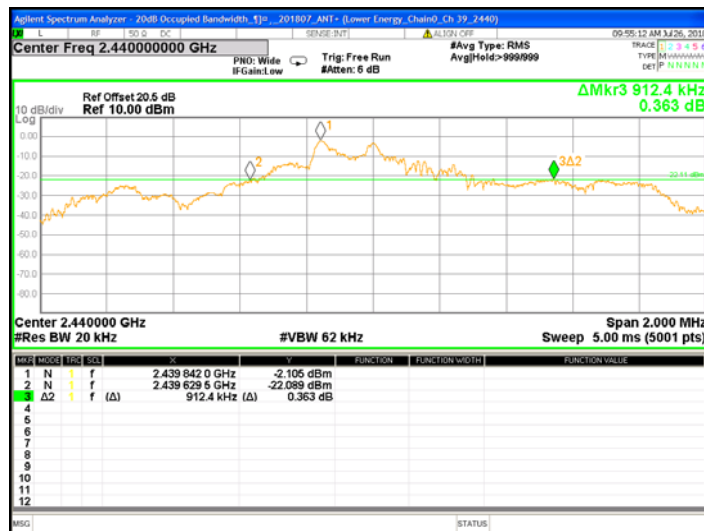

20dB Bandwidth @ ANT+ Channel High

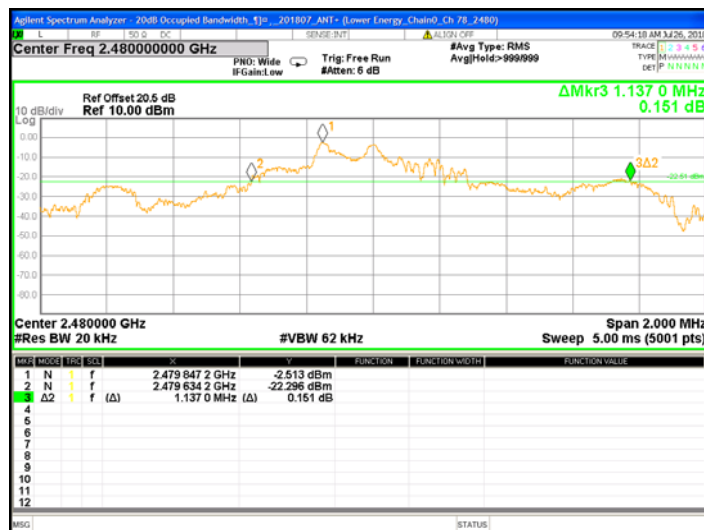

4. Radiated emission test FCC 15.249 (C)

4.1 Operating environment

Temperature:	25	°C
Relative Humidity:	50	%
Atmospheric Pressure:	1008	hPa

4.2 Test setup & procedure

Radiated emission from 9kHz to 30MHz uses Loop Antenna:

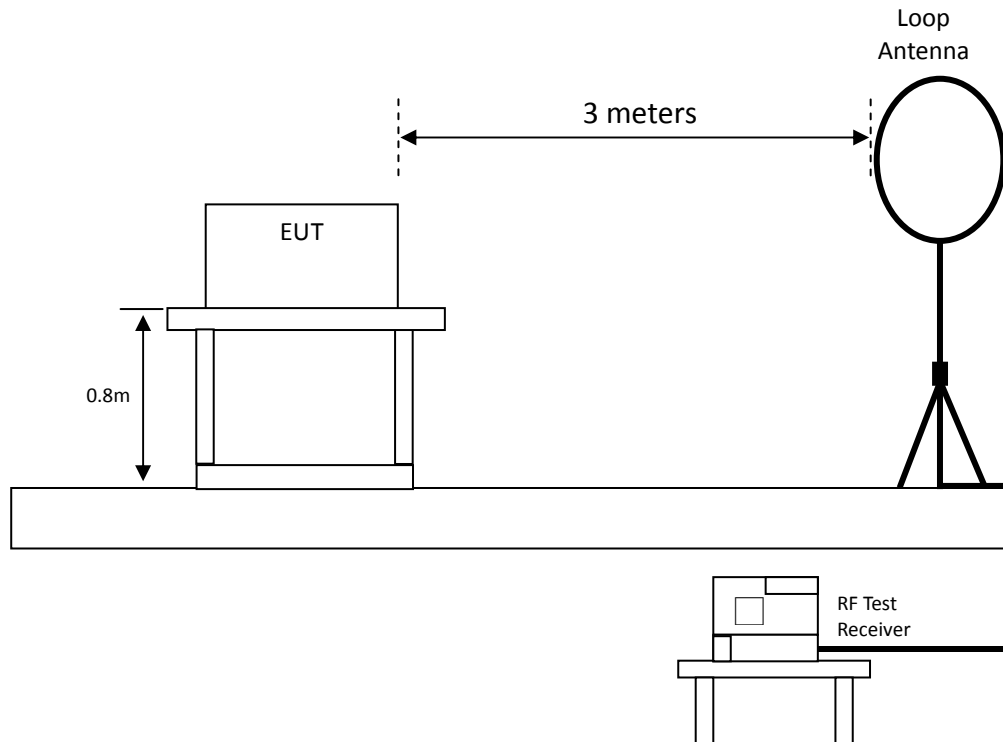

Radiated emission below 1GHz using Bilog Antenna

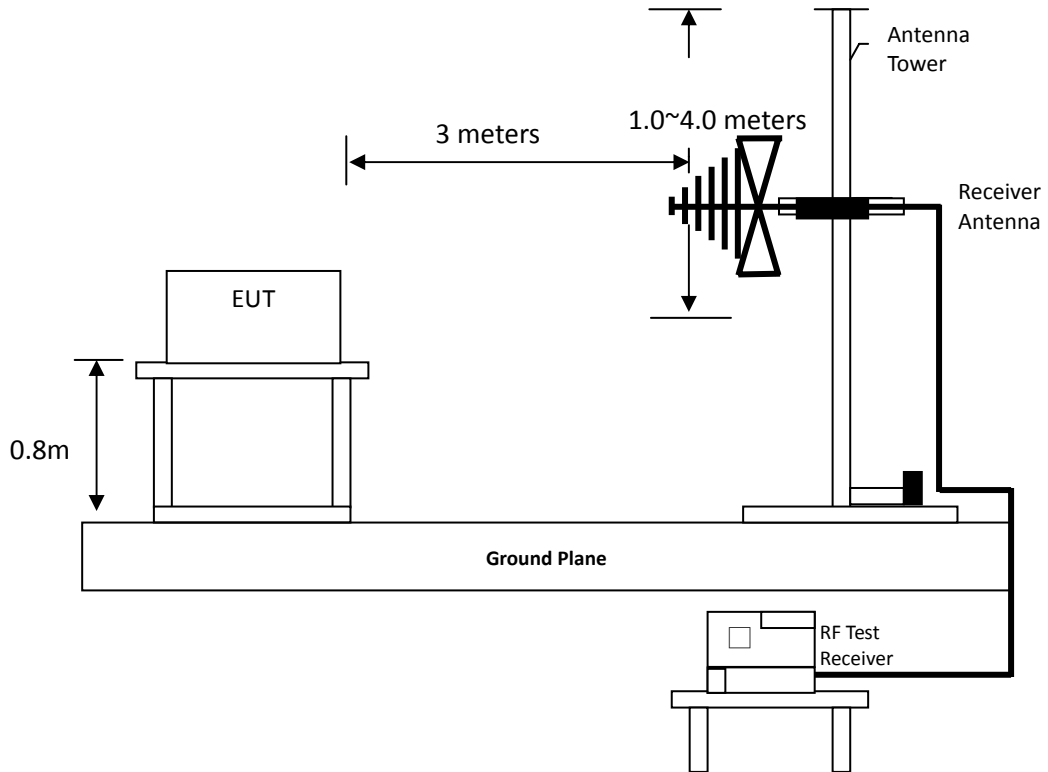

Radiated emission above 1GHz using Horn Antenna

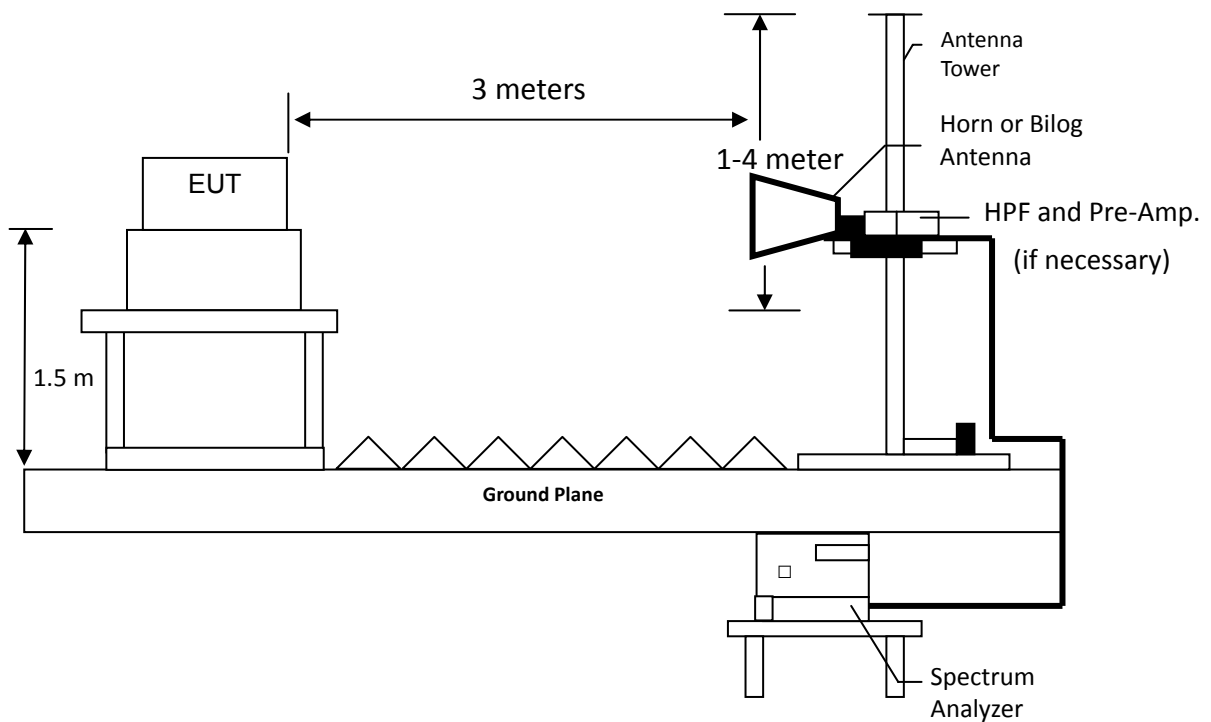

TEST REPORT

Radiated emissions were investigated cover the frequency range from 30MHz to 1000MHz using a receiver RBW of 120kHz record QP reading, and the frequency over 1GHz using a spectrum analyzer RBW of 1MHz and 10Hz VBW record Average reading. (15.209 paragraph), the Peak reading (1 MHz RBW/ 3 MHz VBW) recorded also on the report.

The EUT for testing is arranged on a turntable. If some peripherals apply to the EUT, the peripherals will be connected to EUT and the whole system. During the test, all cables were arranged to produce worst-case emissions. The signal is maximized through rotation. The height of antenna and polarization is changing constantly for exploring for maximum signal level. The height of antenna can be up to 4 meters and down to 1 meter.

The measurement for radiated emission will be done at the distance of three meters unless the signal level is too low to measure at that distance. In the case of the reading under noise floor, a pre-amplifier is used and/or the test is conducted at a closer distance. And then all readings are extrapolated back to the equivalent three meter reading using inverse scaling with distance.

4.3 Emission limit**4.3.1 Fundamental and harmonics emission limits**

Frequency (MHz)	Field Strength of Fundamental		Field Strength of Harmonics	
	(mV/m@3m)	(dBuV/m@3m)	(uV/m@3m)	(dBuV/m@3m)
2400-2483.5	50	94	500	54

TEST REPORT

4.3.2 General radiated emission limits

Emissions radiated outside of the specified frequency bands, except for harmonics, shall be attenuated by at least 50dB below the level of the fundamental or to the general radiated emission limits in paragraph 15.209, whichever is the lesser attenuation.

Frequency MHz	15.209 Limits (dBµV/m@3m)
30-88	40
88-216	43.5
216-960	46
Above 960	54

Remark:

1. In the above table, the tighter limit applies at the band edges.
2. Distance refers to the distance in meters between the measuring instrument antenna and the closed point of any part of the device or system

4.4 Radiated spurious emission test data

4.4.1 Measurement results: frequency range from 9 kHz to 30 MHz

EUT: PLTN-RB1VO

Polarity (circle)	Frequency (MHz)	Detection value	Factor (dB/m)	Reading (dBµV)	Value (dBµV/m)	Limit @ 3m (dBµV/m)	Tolerance (dB)
Plane	0.02	PK	19.26	27.91	47.17	121.58	-74.41
Plane	0.03	PK	19.48	29.51	48.99	118.06	-69.07
Plane	0.07	PK	18.96	31.04	50.00	110.70	-60.70
Plane	0.09	PK	18.80	30.71	49.51	108.52	-59.01
Plane	0.10	QP	18.77	31.41	50.18	107.60	-57.42
Plane	0.13	PK	18.74	27.27	46.01	105.33	-59.32
Plane	0.15	PK	18.73	33.95	52.68	104.08	-51.40
Plane	0.21	PK	18.73	30.47	49.20	101.16	-51.96
Plane	0.33	PK	18.75	27.66	46.41	97.23	-50.82
Plane	0.45	PK	18.67	25.32	43.99	94.54	-50.55
Plane	0.57	QP	18.63	23.70	42.33	72.49	-30.16
Plane	0.69	QP	18.61	22.20	40.81	70.83	-30.02

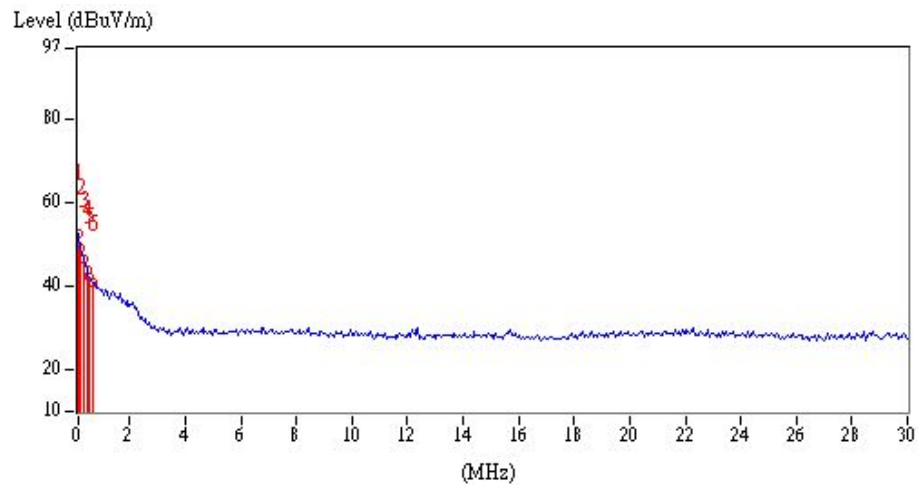
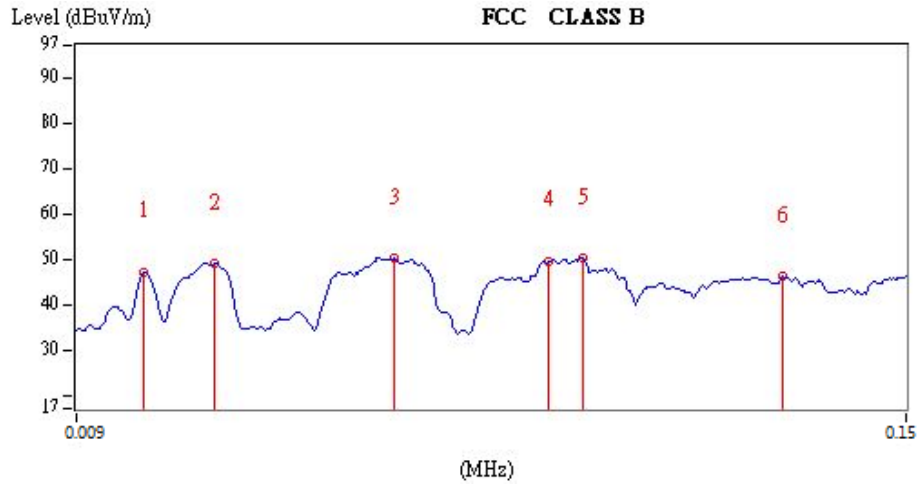

TEST REPORT

4.4.2 Measurement results: frequencies equal to or less than 1 GHz

The test was performed continuously transmitting mode. The worst case occurred at TX Channel high

EUT: PLTN-RB1VO
 Worst case: TX Channel high

Ant. Pol. (H/V)	Frequency (MHz)	Spectrum Analyzer Detector	Correction Factor (dB/m)	Reading (dBμV)	Corrected Reading (dBμV/m)	Limit @ 3 m (dBμV/m)	Margin (dB)
Vertical	39.70	QP	19.92	10.48	30.40	40.00	-9.60
Vertical	643.04	QP	29.61	11.27	40.88	46.00	-5.12
Vertical	714.82	QP	30.84	11.65	42.49	46.00	-3.51
Vertical	786.60	QP	31.95	9.23	41.18	46.00	-4.82
Vertical	858.38	QP	32.78	11.96	44.74	46.00	-1.26
Vertical	930.16	QP	33.68	4.46	38.14	46.00	-7.86

Remark: Corr. Factor = Antenna Factor + Cable Loss

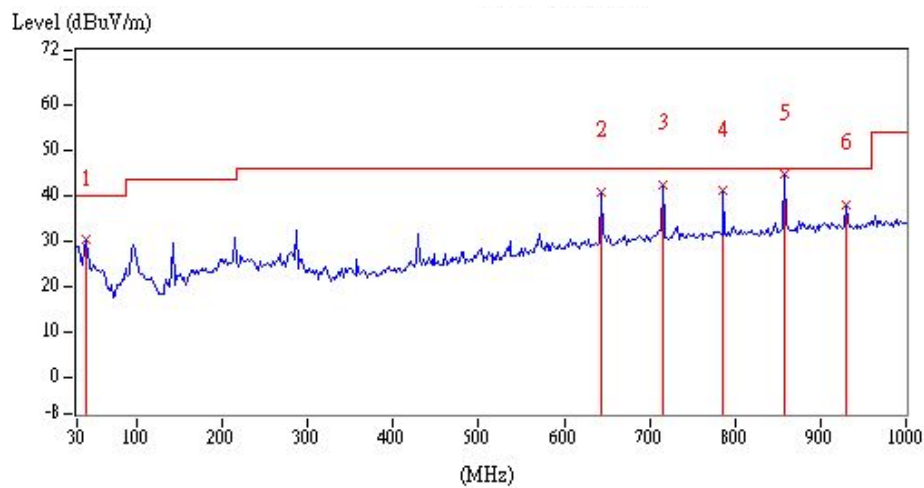

TEST REPORT

EUT: PLTN-RB1VO
 Worst case: TX Channel high

Ant. Pol. (H/V)	Frequency (MHz)	Spectrum Analyzer Detector	Correction Factor (dB/m)	Reading (dB μ V)	Corrected Reading (dB μ V/m)	Limit @ 3 m (dB μ V/m)	Margin (dB)
Horizontal	214.30	QP	18.85	22.77	41.62	43.50	-1.88
Horizontal	357.86	QP	23.16	12.59	35.75	46.00	-10.25
Horizontal	643.04	QP	29.61	6.96	36.57	46.00	-9.43
Horizontal	714.82	QP	30.84	9.32	40.16	46.00	-5.84
Horizontal	786.60	QP	31.95	13.60	45.55	46.00	-0.45
Horizontal	858.38	QP	32.78	12.63	45.41	46.00	-0.59

Remark: Corr. Factor = Antenna Factor + Cable Loss

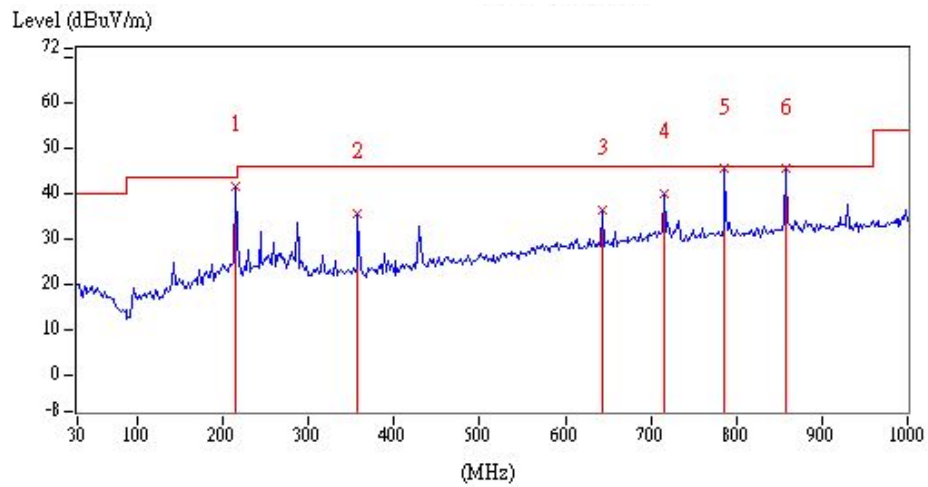

TEST REPORT

4.4.3 Measurement results: frequency above 1GHz

EUT: PLTN-RB1VO

Mode	Frequency (MHz)	Spectrum Analyzer Detector	Ant. Pol. (H/V)	Correction Factor (dB/m)	Reading (dBμV)	Corrected Reading (dBμV/m)	Limit @ 3 m (dBμV/m)	Margin (dB)
ANT+_Ch Low	1864	PK	V	34.32	19.66	53.98	74.00	-20.02
	1864	AV	V	34.32	2.31	36.63	54.00	-17.37
	1948	PK	V	35.32	19.17	54.49	74.00	-19.51
	1948	AV	V	35.32	1.53	36.85	54.00	-17.15
	2128	PK	V	35.75	23.86	59.61	74.00	-14.39
	2128	AV	V	35.75	5.95	41.70	54.00	-12.30
	3180	PK	V	2.07	46.63	48.70	74.00	-25.30
	4260	PK	V	4.16	46.78	50.94	74.00	-23.06
	4804	PK	V	5.63	46.25	51.88	74.00	-22.12
	5325	PK	V	6.65	37.46	44.11	74.00	-29.89
	6390	PK	V	9.88	35.93	45.81	74.00	-28.19
	1356	PK	H	29.73	15.74	45.47	74.00	-28.53
	1864	PK	H	34.32	14.63	48.95	74.00	-25.05
	2136	PK	H	35.74	18.30	54.04	74.00	-19.96
	2136	AV	H	35.74	4.13	39.87	54.00	-14.13
	4260	PK	H	4.16	36.74	40.90	74.00	-33.10
4804	PK	H	5.63	43.89	49.52	74.00	-24.48	
ANT+_Ch Mid	1360	PK	V	29.74	12.78	42.52	74.00	-31.48
	1864	PK	V	34.32	16.98	51.30	74.00	-22.70
	1944	AV	V	35.27	15.66	50.93	74.00	-23.07
	2132	PK	V	35.74	21.32	57.06	74.00	-16.94
	2132	AV	V	35.74	5.49	41.23	54.00	-12.77
	3180	PK	V	2.07	45.74	47.81	74.00	-26.19
	4245	PK	V	4.13	43.74	47.87	74.00	-26.13
	4880	PK	V	5.90	40.04	45.94	74.00	-28.06
	5310	PK	V	6.63	38.70	45.33	74.00	-28.67
	6000	PK	V	8.39	34.18	42.57	74.00	-31.43
	1360	PK	H	29.74	15.41	45.15	74.00	-28.85
	2128	PK	H	35.75	15.46	51.21	74.00	-22.79
	4260	PK	H	4.16	36.63	40.79	74.00	-33.21
	4880	PK	H	5.90	39.27	45.17	74.00	-28.83

Mode	Frequency (MHz)	Spectrum Analyzer Detector	Ant. Pol. (H/V)	Correction Factor (dB/m)	Reading (dBμV)	Corrected Reading (dBμV/m)	Limit @ 3 m (dBμV/m)	Margin (dB)
ANT+_Ch High	1864	PK	V	34.32	16.95	51.27	74.00	-22.73
	1944	PK	V	35.27	21.23	56.50	74.00	-17.50
	1944	AV	V	35.27	3.52	38.79	54.00	-15.21
	2128	PK	V	35.75	23.00	58.75	74.00	-15.25
	2128	AV	V	35.75	5.77	41.52	54.00	-12.48
	4260	PK	V	4.16	45.68	49.84	74.00	-24.16
	4960	PK	V	6.19	42.06	48.25	74.00	-25.75
	5325	PK	V	6.65	37.64	44.29	74.00	-29.71
	6000	PK	V	8.39	34.62	43.01	74.00	-30.99
	6375	PK	V	9.82	34.10	43.92	74.00	-30.08
	2124	PK	H	35.76	15.83	51.59	74.00	-22.41
	4260	PK	H	4.16	35.10	39.26	74.00	-34.74
	4960	PK	H	6.19	43.24	49.43	74.00	-24.57

Remark: Correction Factor = Antenna Factor + Cable Loss + High Pass Filter Loss - Pre_Amplifier Gain

4.4.4 Measurement results: Fundamental

EUT: PLTN-RB1VO

Mode	Frequency (MHz)	Spectrum Analyzer Detector	Ant. Pol. (H/V)	Correction Factor (dB/m)	Reading (dBμV)	Corrected Reading (dBμV/m)	Limit @ 3 m (dBμV/m)	Margin (dB)
ANT+_Ch Low	2402	PK	V	35.35	51.77	87.12	114.00	-26.88
		AV	V	35.35	-0.38	34.97	94.00	-59.03
		PK	H	35.35	55.11	90.46	114.00	-23.54
		AV	H	35.35	-1.17	34.18	94.00	-59.82
ANT+_Ch Mid	2440	PK	V	35.29	54.80	90.09	114.00	-23.91
		AV	V	35.29	-0.72	34.57	94.00	-59.43
		PK	H	35.29	58.05	93.34	114.00	-20.66
		AV	H	35.29	-0.76	34.53	94.00	-59.47
ANT+_Ch High	2480	PK	V	35.23	56.75	91.98	114.00	-22.02
		AV	V	35.23	-0.94	34.29	94.00	-59.71
		PK	H	35.23	58.79	94.02	114.00	-19.98
		AV	H	35.23	-0.60	34.63	94.00	-59.37

Remark: Correction Factor = Antenna Factor + Cable Loss

5. Radiated emission on the band edge FCC 15.249(d)

5.1 Operating environment

Temperature:	25	°C
Relative Humidity:	50	%
Atmospheric Pressure:	1008	hPa

5.2 Radiated emission on the band edge test data

Emissions radiated outside of the specified frequency bands, except for harmonics, shall be attenuated by at least 50 dB below the level of the fundamental or to the general radiated emission limits in §15.209, whichever is the lesser attenuation.

Mode	Frequency (MHz)	Spectrum Analyzer Detector	Ant. Pol. (H/V)	Correction Factor (dB/m)	Reading (dBμV)	Corrected Reading (dBμV/m)	Limit @ 3 m (dBμV/m)	Margin (dB)	Restricted band (MHz)
ANT+	2377.51	PK	V	35.38	9.66	45.04	74	-28.96	2310~2390
	2386.96	AV	V	35.37	-2.87	32.50	54	-21.50	
	2483.50	PK	V	35.23	26.52	61.75	74	-12.25	2483.5~2500
	2486.84	AV	V	35.22	-2.81	32.41	54	-21.59	

Remark: Correction Factor = Antenna Factor + Cable Loss

Bandedge @ mode ANT+ Channel Low Peak

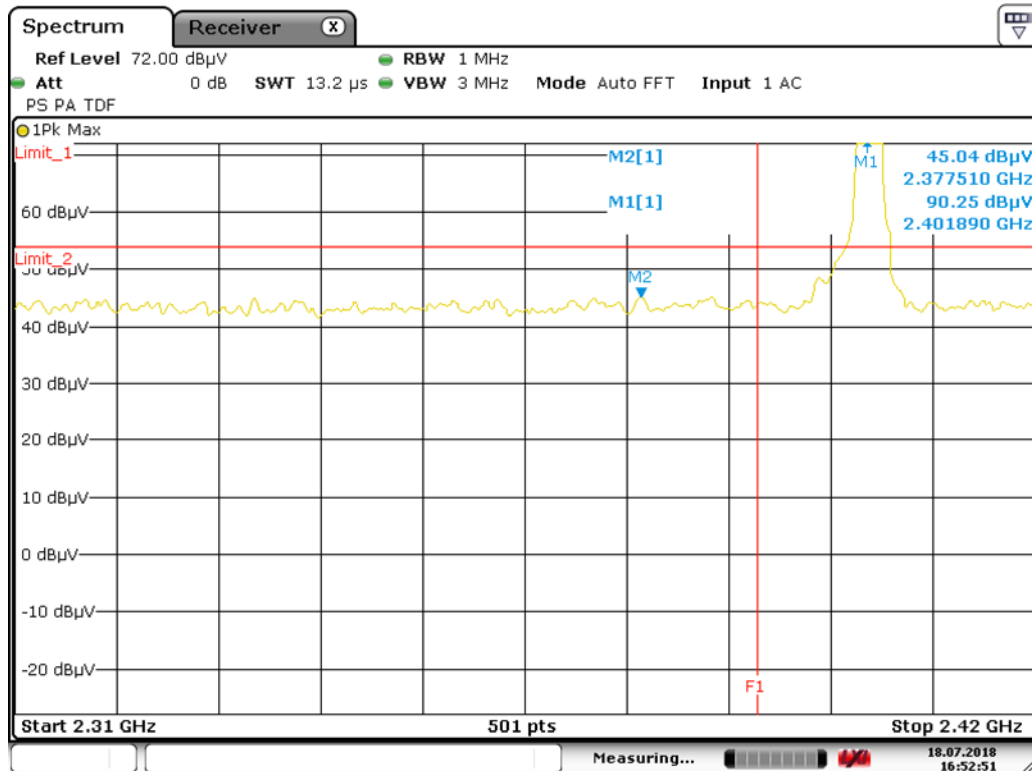

Date: 18.JUL.2018 16:52:51

Bandedge @ mode ANT+ Channel Low Average

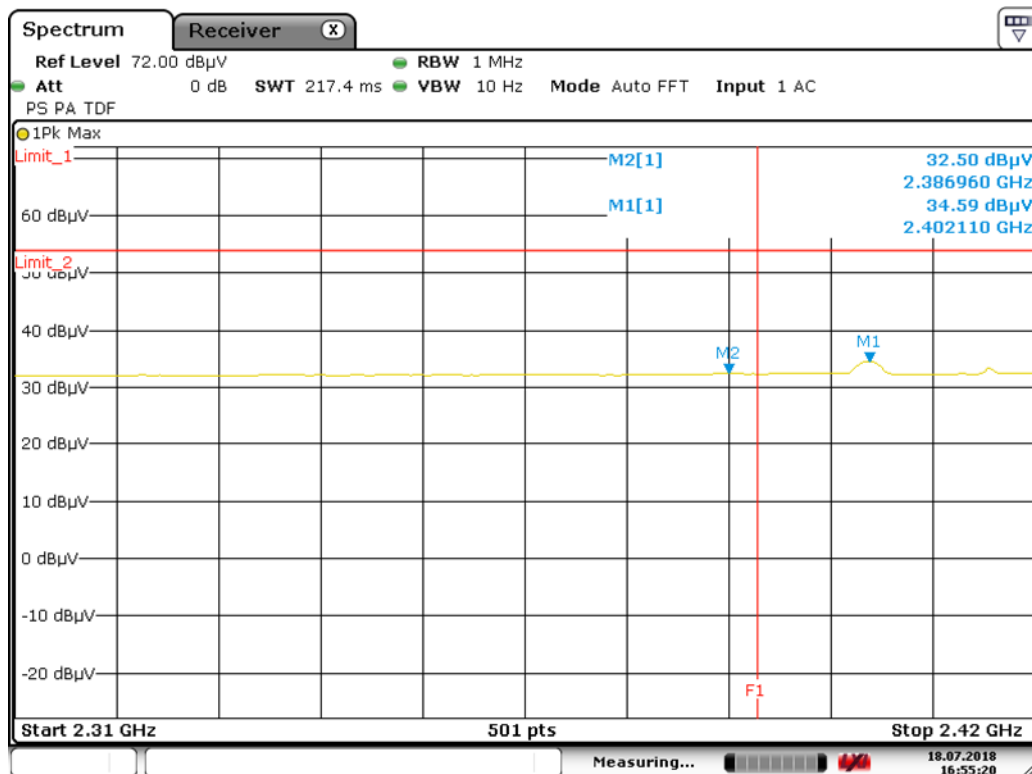

Date: 18.JUL.2018 16:55:21

Bandedge @ mode ANT+ Channel High Peak

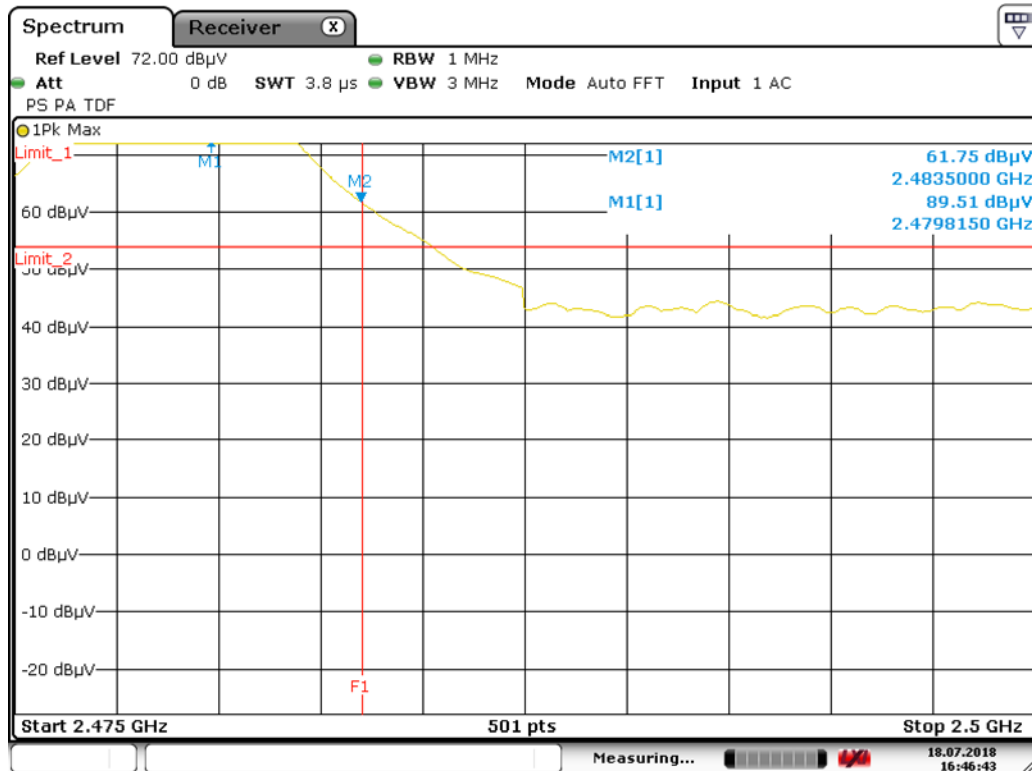

Date: 18.JUL.2018 16:46:44

Bandedge @ mode ANT+ Channel High Average

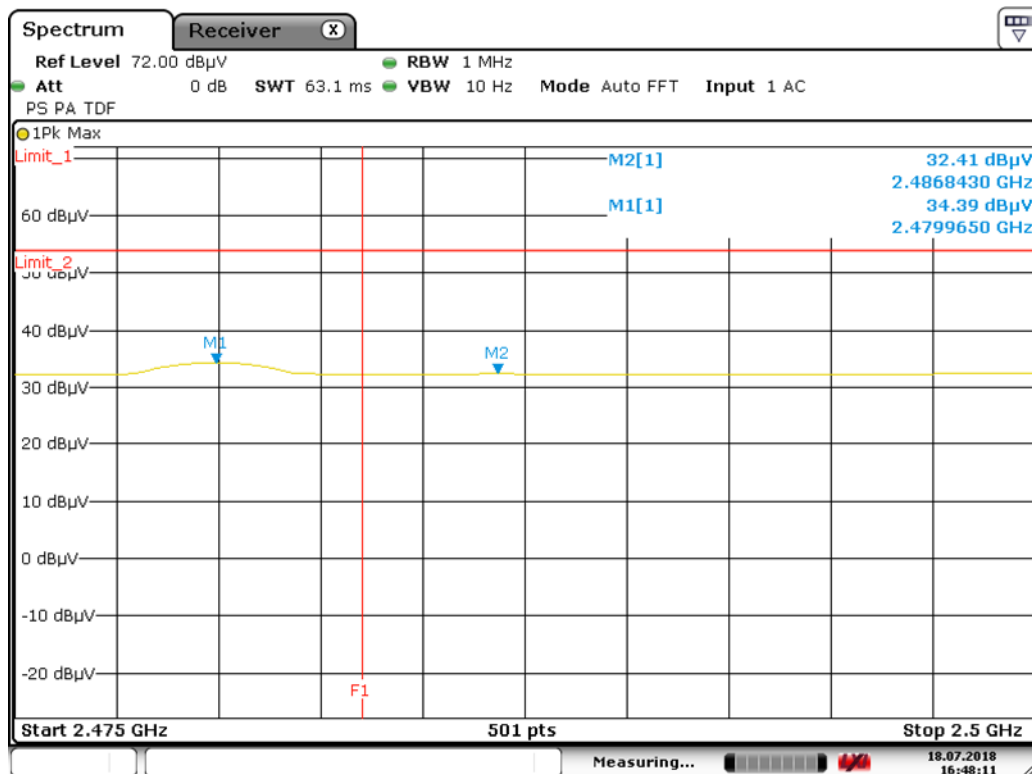

Date: 18.JUL.2018 16:48:12

6. AC Power Line Conducted Emission

6.1 Measuring instrument setting

Receiver Function	Setting
Detector	QP
Start frequency	0.15MHz
Stop frequency	30MHz
IF bandwidth	9 kHz
Attenuation	10dB

6.2 Test Procedure

Step 1	Configure the EUT according to ANSI C63.10:2013. The EUT or host of EHT has to be placed 0.4 meter far from the conducting wall of the shielding room and at least 80 centimeters from any other grounded conducting surface.
Step 2	Connect EUT or host of EUT to the power mains through a line impedance stabilization network.
Step 3	All the companion devices are connected to the other LISN. The LISN should provide 50Uh/50ohms coupling impedance.
Step 4	The frequency range from 150 kHz to 30MHz was searched.
Step 5	Set the test-receiver system to peak detector and specified bandwidth with maximum hold mode.
Step 6	The measurement has to be done between each power line and ground at the power terminal.

6.3 Test Diagram

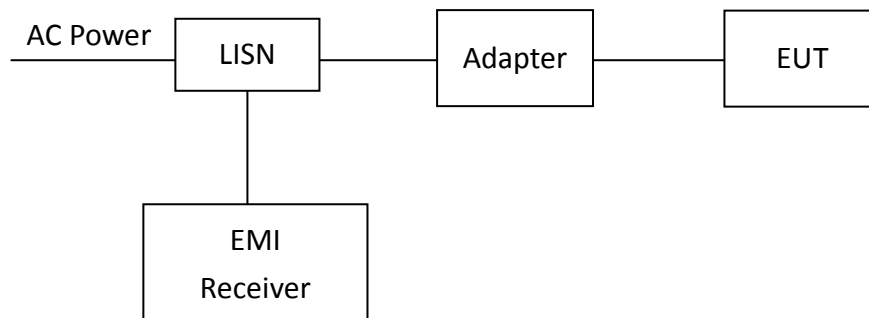

6.4 Limit

Frequency (MHz)	Conducted Limit (dBuV)	
	Q.P.	Ave.
0.15~0.50	66 – 56	56 – 46
0.50~5.00	56	46
5.00~30.0	60	50

6.5 Operating Environment Condition

Temperature (°C) :	25
Relative Humidity (%) :	50
Atmospheric Pressure (hPa) :	1010
Test Date :	2018/07/25

6.6 Test Results

Phase: Live Line
 Model No.: PLTN-RB1VO
 Test Condition: Tx mode

Frequency (MHz)	Corr. Factor (dB)	Reading QP (dBuV)	Level QP (dBuV)	Limit QP (dBuV)	Reading AV (dBuV)	Level AV (dBuV)	Limit AV (dBuV)	Margin (dB)	
								QP	AV
0.156	0.08	47.94	48.02	65.69	33.97	34.05	55.69	-17.67	-21.64
0.273	0.09	33.37	33.46	61.03	19.87	19.96	51.03	-27.57	-31.07
0.440	0.10	38.40	38.50	57.07	31.93	32.03	47.07	-18.57	-15.03
2.946	0.27	28.15	28.43	56.00	17.54	17.82	46.00	-27.57	-28.18
14.440	0.92	40.97	41.90	60.00	31.33	32.25	50.00	-18.10	-17.75
23.140	1.26	26.39	27.65	60.00	19.93	21.18	50.00	-32.35	-28.82

Remark:

1. Corr. Factor (dB) = LISN Factor (dB) + Cable Loss (dB)
2. Level (dBuV) = Corr. Factor (dB) + Reading (dBuV)
3. Margin (dB) = Level (dBuV) – Limit (dBuV)

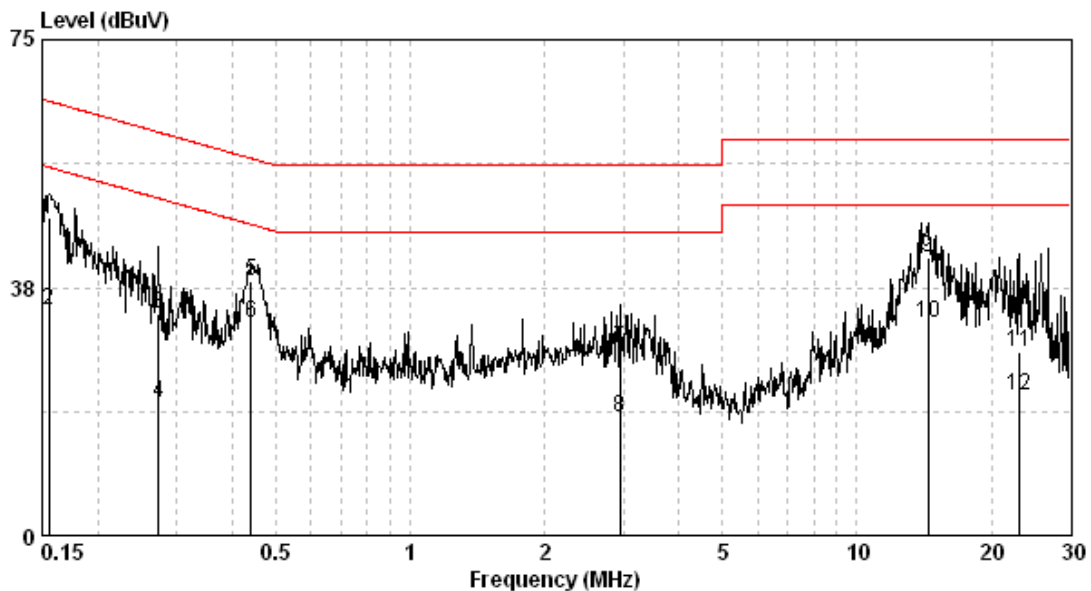

TEST REPORT

Phase: Neutral Line
 Model No.: PLTN-RB1VO
 Test Condition: Tx mode

Frequency (MHz)	Corr. Factor (dB)	Reading QP (dBuV)	Level QP (dBuV)	Limit QP (dBuV)	Reading AV (dBuV)	Level AV (dBuV)	Limit AV (dBuV)	Margin (dB)	
								QP	AV
0.158	0.08	47.50	47.58	65.56	34.20	34.28	55.56	-17.98	-21.28
0.249	0.09	34.29	34.37	61.78	21.64	21.73	51.78	-27.40	-30.05
0.444	0.10	38.55	38.65	56.98	32.42	32.52	46.98	-18.33	-14.46
0.989	0.15	28.61	28.76	56.00	21.68	21.83	46.00	-27.24	-24.17
3.472	0.28	28.45	28.73	56.00	19.91	20.19	46.00	-27.27	-25.81
14.594	0.75	42.10	42.85	60.00	32.89	33.63	50.00	-17.15	-16.37

Remark:

1. Corr. Factor (dB) = LISN Factor (dB) + Cable Loss (dB)
2. Level (dBuV) = Corr. Factor (dB) + Reading (dBuV)
3. Margin (dB) = Level (dBuV) – Limit (dBuV)

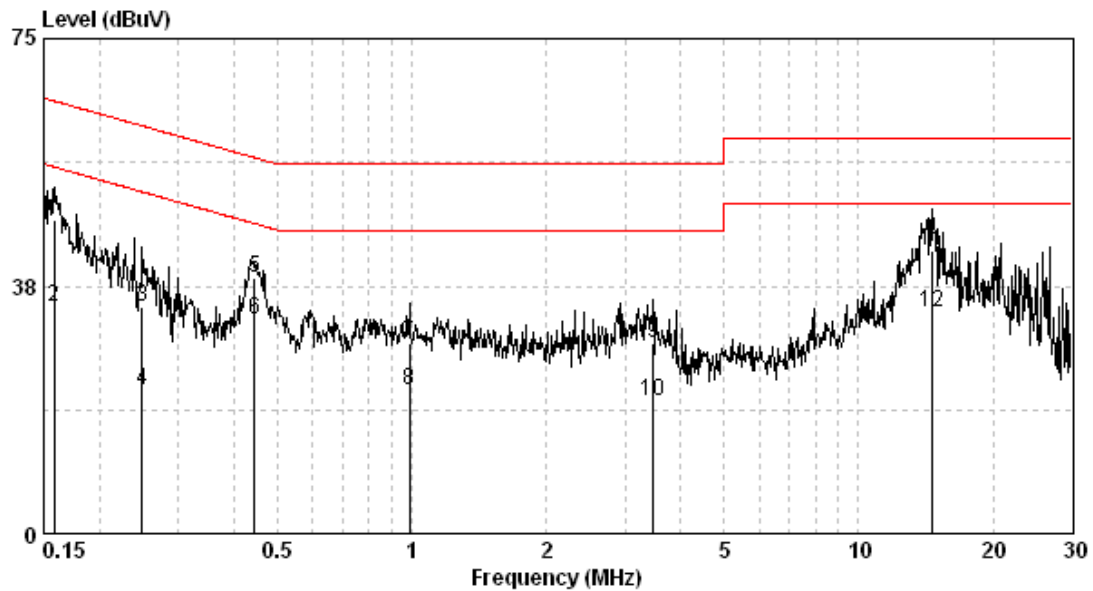

Appendix A: Test equipment list

Test Equipment/ Test site	Brand	Model No.	Serial No.	Calibration Date	Next Calibration Date
ESCI EMI Test Receiver	Rohde & Schwarz	ESCI	100018	2017/11/21	2018/11/20
Spectrum Analyzer	Rohde & Schwarz	FSP30	100245	2018/02/23	2019/02/22
Horn Antenna (1-18G)	SHWARZBECK	BBHA 9120 D	9120D-456	2018/01/23	2019/01/22
Horn Antenna (14-42G)	SHWARZBECK	BBHA 9170	BBHA9170159	2017/09/04	2020/09/02
Broadband Antenna	SHWARZBECK	VULB 9168	9168-172	2018/04/23	2019/04/22
Pre-Amplifier	EMC Co.	EMC12635SE	980205	2017/11/28	2018/11/27
Pre-Amplifier	MITEQ	JS4-26004000--27-8A	828825	2017/08/23	2018/08/22
Power Meter	Anritsu	ML2495A	0844001	2017/10/18	2018/10/17
Power Sensor	Anritsu	MA2411B	0738452	2017/10/18	2018/10/17
Signal Analyzer	Agilent	N9030A	MY51380492	2017/08/29	2018/08/28
966-2(A) Cable 9kHz~26.5GHz	SUHNER	SMA / EX 100	N/A	2017/08/15	2018/08/14
966-2(B) Cable 9kHz~26.5GHz	SUHNER	SUCOFLEX 104P	CB0005	2017/08/15	2018/08/14
RF Cable 9kHz~26.5GHz	SUHNER	SUCOFLEX 102	CB0006	2018/05/03	2019/05/02

Note: No Calibration Required (NCR).

Test Equipment/ Test site	Brand	Model No.	Serial No.	Calibration Date	Next Calibration Date
966-2_3m Semi-Anechoic Chamber	966_2	CEM-966_2	N/A	2018/03/05	2019/03/04
966-2_3m Semi-Anechoic Chamber	966_2	CEM-966_2	N/A	2018/03/28	2019/03/27
High Pass Filter	Wainwright	WHKX3.0/ 18G-12SS	N/A	2018/06/01	2019/05/31
Active Loop Antenna	SCHWARZBECK MESS-ELEKTRONIC	FMZB1519	1519-067	2018/04/17	2019/04/16
Active Loop Antenna	SCHWARZBECK MESS-ELEKTRONIC	FMZB1519	1519-067	2018/04/17	2019/04/16
EMI Test Receiver	R&S	ESR7	101822	2018/06/12	2019/06/11
Two-Line V-Network	R&S	ENV216	101160	2018/07/24	2019/07/23
Two-Line -V-Network	R&S	ESH3-Z5	838979/014	2017/09/13	2018/09/12
CON-2 Shielded Room	N/A	N/A	N/A	NCR	NCR
CON-2 Cable	SUHNER	EMCCFD300-BM- NM-6000	170502	2018/05/07	2019/05/06
Test software	Audix	e3	4.20040112L	NCR	NCR

Note: No Calibration Required (NCR).

Appendix B: Measurement Uncertainty

This uncertainty represents an expanded uncertainty expressed at approximately the 95 % confidence level using a coverage factor of $k=2$.

Item	Uncertainty
Vertically polarized radiated disturbances from 30MHz~1GHz in a semi-anechoic chamber at a distance of 3m	5.14 dB
Horizontally polarized radiated disturbances from 30MHz~1GHz in a semi-anechoic chamber at a distance of 3m	5.22 dB
Vertically polarized Radiated disturbances from 1GHz~18GHz in a semi-anechoic chamber at a distance of 3m	3.64 dB
Horizontally polarized Radiated disturbances from 1GHz~18GHz in a semi-anechoic chamber at a distance of 3m	3.64 dB
Vertically polarized Radiated disturbances from 18GHz~40GHz in a semi-anechoic chamber at a distance of 3m	2.68 dB
Horizontally polarized Radiated disturbances from 18GHz~40GHz in a semi-anechoic chamber at a distance of 3m	2.68 dB
Radiated disturbances from 9kHz~30MHz in a semi-anechoic chamber at a distance of 3m	3.54 dB
Emission on the Band Edge Test	3.64 dB
20dB Bandwidth	1.22 dB
AC Power Line Conducted Emission	2.48 dB