



FCC 47 CFR PART 15 SUBPART C

TEST REPORT

For

Product	Model
Enterprise Tablet Pro	Enterprise Pro
Enterprise Tablet Lite	Enterprise Lite



Trade Name:

Issued to

Merchandising Technologies Inc.
Room 1101 & 1103, 11/F., Premier Center, 20 Cheung Shun Street,
Lai Chi Kok, Kowloon, Hong Kong

Issued by

Compliance Certification Services Inc.
No.11, Wugong 6th Rd., Wugu Dist.,
New Taipei City 24891, Taiwan. (R.O.C.)
<http://www.ccsrf.com>
service@ccsrf.com
Issued Date: September 11, 2013



Note: This report shall not be reproduced except in full, without the written approval of Compliance Certification Services Inc. This document may be altered or revised by Compliance Certification Services Inc. personnel only, and shall be noted in the revision section of the document.



Revision History

Rev.	Issue Date	Revisions	Effect Page	Revised By
00	September 11, 2013	Initial Issue	ALL	Kelly Cheng



TABLE OF CONTENTS

1. TEST RESULT CERTIFICATION.....	4
2. EUT DESCRIPTION	5
3. TEST METHODOLOGY	6
3.1 EUT CONFIGURATION	6
3.2 EUT EXERCISE	6
3.3 GENERAL TEST PROCEDURES	6
3.4 FCC PART 15.205 RESTRICTED BANDS OF OPERATIONS	7
3.5 DESCRIPTION OF TEST MODES	8
4. INSTRUMENT CALIBRATION.....	9
4.1 MEASURING INSTRUMENT CALIBRATION	9
4.2 MEASUREMENT EQUIPMENT USED	9
4.3 MEASUREMENT UNCERTAINTY	10
5. FACILITIES AND ACCREDITATIONS	11
5.1 FACILITIES	11
5.2 EQUIPMENT	11
5.3 TABLE OF ACCREDITATIONS AND LISTINGS	12
6. SETUP OF EQUIPMENT UNDER TEST	13
6.1 SETUP CONFIGURATION OF EUT	13
6.2 SUPPORT EQUIPMENT.....	13
7. FCC PART 15.225 REQUIREMENTS.....	14
7.1 20 DB BANDWIDTH	14
7.2 RADIATED EMISSIONS	16
7.3 FREQUENCY STABILITY	21
7.4 POWERLINE CONDUCTED EMISSIONS	23
APPENDIX I PHOTOGRAPHS OF TEST SETUP	26
APPENDIX 1 - PHOTOGRAPHS OF EUT	



1. TEST RESULT CERTIFICATION

Applicant: Merchandising Technologies Inc.
Room 1101 & 1103, 11/F., Premier Center, 20 Cheung Shun Street,
Lai Chi Kok, Kowloon, Hong Kong

Equipment Under Test / Model:

Product	Model
Enterprise Tablet Pro	Enterprise Pro
Enterprise Tablet Lite	Enterprise Lite



Trade Name:

Date of Test: August 18 ~ September 10, 2013

APPLICABLE STANDARDS	
STANDARD	TEST RESULT
FCC 47 CFR Part 15 Subpart C	No non-compliance noted

We hereby certify that:

The above equipment was tested by Compliance Certification Services Inc. The test data, data evaluation, test procedures, and equipment configurations shown in this report were made in accordance with the procedures given in ANSI C63.4: 2009 and the energy emitted by the sample tested as described in this report is in compliance with the requirements of FCC Rules Part 15.225.

The test results of this report relate only to the tested sample identified in this report.

Approved by:

Reviewed by:

Miller Lee
Section Manager
Compliance Certification Services Inc.

Angel Cheng
Section Manager
Compliance Certification Services Inc.



2. EUT DESCRIPTION

Product	Product		Model	
	Enterprise Tablet Pro		Enterprise Pro	
	Enterprise Tablet Lite		Enterprise Lite	
Trade Name				
Model Difference	Product	Enterprise Tablet Pro	Enterprise Tablet Lite	
	Model	Enterprise Pro	Enterprise Lite	
	HDMI port	○	×	
	Ethernet port	○	×	
	Audio port	○	×	
	USB port	○	×	
	DC port	○	○	
Received Date	August 05, 2013			
Power Supply	VDC from Power Adapter 1. Enertronix / EXA0904YJ I/P: 100-240V, 50-60Hz, 1.5A O/P: 24V, 3.75A 2. Enertronix / EXA0703YJ I/P: 100-240V, 50-60Hz, 1.5A O/P: 24V, 2.71A			
Frequency Range	13.56MHz			
Modulation Technique	ASK			
Number of Channels	1 Channel			
Antenna Designation	Loop Antenna / Gain: 0 dBi			

Remark:

1. The sample selected for test was engineering sample that approximated to production product and was provided by manufacturer.
2. This submittal(s) (test report) is intended for FCC ID: 2AA2X153-0761-00 filing to comply with Section 15.225 of the FCC Part 15, Subpart C Rules.



3. TEST METHODOLOGY

The tests documented in this report were performed in accordance with ANSI C63.4: 2009 and FCC CFR 47 Part 15.207, 15.209 and 15.225.

3.1 EUT CONFIGURATION

The EUT configuration for testing is installed on RF field strength measurement to meet the Commissions requirement and operating in a manner that intends to maximize its emission characteristics in a continuous normal application.

3.2 EUT EXERCISE

The EUT was operated in the engineering mode to fix the TX frequency that was for the purpose of the measurements.

3.3 GENERAL TEST PROCEDURES

Conducted Emissions

The EUT is placed on the turntable, which is 0.8 m above ground plane. According to the requirements in Section 13.1.4.1 of ANSI C63.4: 2009. Conducted emissions from the EUT measured in the frequency range between 0.15 MHz and 30MHz using CISPR Quasi-peak and average detector modes.

Radiated Emissions

The EUT is placed on a turn table, which is 0.8 m above ground plane. The turntable shall rotate 360 degrees to determine the position of maximum emission level. EUT is set 3m away from the receiving antenna, which varied from 1m to 4m to find out the highest emission. And also, each emission was to be maximized by changing the polarization of receiving antenna both horizontal and vertical. In order to find out the maximum emissions, exploratory radiated emission measurements were made according to the requirements in Section 13.1.4.1 of ANSI C63.4: 2009.



3.4 FCC PART 15.205 RESTRICTED BANDS OF OPERATIONS

(a) Except as shown in paragraph (d) of this section, only spurious emissions are permitted in any of the frequency bands listed below:

MHz	MHz	MHz	GHz
0.090 - 0.110	16.42 - 16.423	399.9 - 410	4.5 - 5.15
¹ 0.495 - 0.505	16.69475 - 16.69525	608 - 614	5.35 - 5.46
2.1735 - 2.1905	16.80425 - 16.80475	960 - 1240	7.25 - 7.75
4.125 - 4.128	25.5 - 25.67	1300 - 1427	8.025 - 8.5
4.17725 - 4.17775	37.5 - 38.25	1435 - 1626.5	9.0 - 9.2
4.20725 - 4.20775	73 - 74.6	1645.5 - 1646.5	9.3 - 9.5
6.215 - 6.218	74.8 - 75.2	1660 - 1710	10.6 - 12.7
6.26775 - 6.26825	108 - 121.94	1718.8 - 1722.2	13.25 - 13.4
6.31175 - 6.31225	123 - 138	2200 - 2300	14.47 - 14.5
8.291 - 8.294	149.9 - 150.05	2310 - 2390	15.35 - 16.2
8.362 - 8.366	156.52475 -	2483.5 - 2500	17.7 - 21.4
8.37625 - 8.38675	156.52525	2655 - 2900	22.01 - 23.12
8.41425 - 8.41475	156.7 - 156.9	3260 - 3267	23.6 - 24.0
12.29 - 12.293	162.0125 - 167.17	3332 - 3339	31.2 - 31.8
12.51975 - 12.52025	167.72 - 173.2	3345.8 - 3358	36.43 - 36.5
12.57675 - 12.57725	240 - 285	3600 - 4400	(²)
13.36 - 13.41	322 - 335.4		

¹ Until February 1, 1999, this restricted band shall be 0.490-0.510 MHz.

² Above 38.6

(b) Except as provided in paragraphs (d) and (e), the field strength of emissions appearing within these frequency bands shall not exceed the limits shown in Section 15.209. At frequencies equal to or less than 1000 MHz, compliance with the limits in Section 15.209 shall be demonstrated using measurement instrumentation employing a CISPR quasi-peak detector. Above 1000 MHz, compliance with the emission limits in Section 15.209 shall be demonstrated based on the average value of the measured emissions. The provisions in Section 15.35 apply to these measurements.



3.5 DESCRIPTION OF TEST MODES

The EUT (model: Enterprise Pro.) had been tested under operating condition.

Software used to control the EUT for staying in continuous transmitting and receiving mode was programmed.

After verification, all tests carried out were with the worst-case test modes as shown below except radiated spurious emission worst case was in normal link mode.

RF ID: Channel 13.56MHz was chosen for full testing.



4. INSTRUMENT CALIBRATION

4.1 MEASURING INSTRUMENT CALIBRATION

The measuring equipment, which was utilized in performing the tests documented herein, has been calibrated in accordance with the manufacturer's recommendations for utilizing calibration equipment, which is traceable to recognized national standards.

4.2 MEASUREMENT EQUIPMENT USED

Equipment Used for Emissions Measurement

Remark: Each piece of equipment is scheduled for calibration once a year and Loop Antenna is scheduled for calibration once three years.

Conducted Emissions Test Site				
Name of Equipment	Manufacturer	Model	Serial Number	Calibration Due
Spectrum Analyzer	Agilent	E4446A	US42510268	11/14/2013
Power Meter	Anritsu	ML2495A	1012009	04/25/2014
Power Sensor	Anritsu	MA2411A	0917072	04/25/2014

Wugu 966 Chamber A				
Name of Equipment	Manufacturer	Model	Serial Number	Calibration Due
Spectrum Analyzer	Agilent	E4446A	US42510268	11/06/2013
EMI Test Receiver	R&S	ESCI	100064	02/28/2014
Pre-Amplifier	Mini-Circuits	ZFL-1000LN	SF350700823	01/12/2014
Pre-Amplifier	MITEQ	AFS44-00102650-42-10P-44	1415367	11/19/2013
Bilog Antenna	Sunol Sciences	JB3	A030105	10/02/2013
Horn Antenna	EMCO	3117	00055165	02/13/2014
Turn Table	CCS	CC-T-1F	N/A	N.C.R
Antenna Tower	CCS	CC-A-1F	N/A	N.C.R
Controller	CCS	CC-C-1F	N/A	N.C.R
Site NSA	CCS	N/A	N/A	12/22/2013
Test S/W	EZ-EMC (CCS-3A1RE)			

Conducted Emission room # A				
Name of Equipment	Manufacturer	Model	Serial Number	Calibration Due
TEST RECEIVER	R&S	ESCI	101201	09/09/2014
LISN (EUT)	SCHWARZBECK	NSLK 8127	8127527	12/11/2013
LISN	SCHWARZBECK	NSLK 8127	8127526	12/11/2013
BNC CABLE	EMCI	5Dr	BNC A6	12/11/2013
Pulse Limiter	R&S	ESH3-Z2	C3010026-2	09/06/2014
THERMO-HYGRO METER	WISEWIND	201A	No. 02	05/14/2014
Test S/W	EZ-EMC			



4.3 MEASUREMENT UNCERTAINTY

PARAMETER	UNCERTAINTY
Powerline Conducted Emission	+/- 1.0717
3M Semi Anechoic Chamber / 30M~200M	+/- 4.0138
3M Semi Anechoic Chamber / 200M~1000M	+/- 3.9483
3M Semi Anechoic Chamber / 1G~8G	+/- 2.5975
3M Semi Anechoic Chamber / 8G~18G	+/- 2.6112
3M Semi Anechoic Chamber / 18G~26G	+/- 2.7389
3M Semi Anechoic Chamber / 26G~40G	+/- 2.9683

Remark: This uncertainty represents an expanded uncertainty expressed at approximately the 95% confidence level using a coverage factor of $k=2$.



5. FACILITIES AND ACCREDITATIONS

5.1 FACILITIES

All measurement facilities used to collect the measurement data are located at

No.163-1, Jhongsheng Rd. Sindian City, Taipei County 23151, Taiwan

Tel: 886-2-2217-0894 / Fax: 886-2-2217-1029

Remark: The conduction emissions test items was tested at Compliance Certification Services Inc. (Sindian Lab.) The test equipments were listed in page 9 and the test data, please refer page 24-25

No.11, Wugong 6th Rd., Wugu Dist., New Taipei City 24891, Taiwan. (R.O.C.)

Tel: 886-2-2299-9720 / Fax: 886-2-2298-4045

No.81-1, Lane 210, Bade 2nd Rd., Lujhu Township, Taoyuan County 33841,

TAIWAN, R.O.C.

Tel: 886-3-324-0332 / Fax: 886-3-324-5235

The sites are constructed in conformance with the requirements of ANSI C63.7, ANSI C63.4 and CISPR Publication 22.

5.2 EQUIPMENT

Radiated emissions are measured with one or more of the following types of linearly polarized antennas: tuned dipole, biconical, log periodic, bi-log, and/or ridged waveguide, horn. Spectrum analyzers with pre-selectors and quasi-peak detectors are used to perform radiated measurements.



Conducted emissions are measured with Line Impedance Stabilization Networks and EMI Test Receivers.

Calibrated wideband preamplifiers, coaxial cables, and coaxial attenuators are also used for making measurements.

All receiving equipment conforms to CISPR Publication 16-1, "Radio Interference Measuring Apparatus and Measurement Methods."



5.3 TABLE OF ACCREDITATIONS AND LISTINGS

Country	Agency	Scope of Accreditation	Logo
USA	FCC	3M Semi Anechoic Chamber (FCC MRA: TW1039) to perform FCC Part 15 measurements	 FCC MRA: TW1039
Taiwan	TAF	LP0002, RTTE01, FCC Method-47 CFR Part 15 Subpart C, D, E, RSS-210, RSS-310 IDA TS SRD, AS/NZS 4268, AS/NZS 4771, TS 12.1 & 12.2, ETSI EN 300 440-1, ETSI EN 300 440-2, ETSI EN 300 328, ETSI EN 300 220-1, ETSI EN 300 220-2, ETSI EN 301 893, ETSI EN 301 489-1/3/7/17 FCC OET Bulletin 65 + Supplement C, EN 50360, EN 50361, EN 50371, RSS 102, EN 50383, EN 50385, EN 50392, IEC 62209, CNS 14958-1, CNS 14959 FCC Method -47 CFR Part 15 Subpart B IEC / EN 61000-3-2, IEC / EN 61000-3-3, IEC / EN 61000-4-2/3/4/5/6/8/11	
Canada	Industry Canada	3M Semi Anechoic Chamber (IC 2324G-1 / IC 2324G-2) to perform	 IC 2324G-1 IC 2324G-2

* No part of this report may be used to claim or imply product endorsement by A2LA or any agency of the US Government.



6. SETUP OF EQUIPMENT UNDER TEST

6.1 SETUP CONFIGURATION OF EUT

See test photographs attached in Appendix I for the actual connections between EUT and support equipment.

6.2 SUPPORT EQUIPMENT

No.	Device Type	Brand	Model	Series No.	FCC ID / BSMI ID	Data Cable	Power Cord
1.	Touch panel	Samsung	XE700T1A	HLVK93CBA0121 4E	N/A	N/A	N/A
2	Earphone	SCE	MIC-5	N/A	N/A	Unshielded, 2.0m	N/A
3	USB Mouse	hp	KB-0316	N/A	R33001	Shielded, 1.8m	N/A
4	USB Keyboard	hp	N/A	390938-001	N/A	Shielded, 1.8m	N/A
5	USB 3.0 HDD	SONY	HD-EG5	N/A	N/A	Shielded, 0.6m	N/A
6	Monitor	Samsung	B2230H	NEBKHMZ80001 8E	R33475	Shielded, 1.5m	Unshielded, 1.8m
7	Server PC	DELL	T3500	8X36VBX	R33002	Unshielded, 20m	Unshielded, 1.8m

Remark:

1. All the equipment/cables were placed in the worst-case configuration to maximize the emission during the test.
2. Grounding was established in accordance with the manufacturer's requirements and conditions for the intended use.



7. FCC PART 15.225 REQUIREMENTS

7.1 20 DB BANDWIDTH

LIMIT

None; for reporting purposes only.

Test Configuration

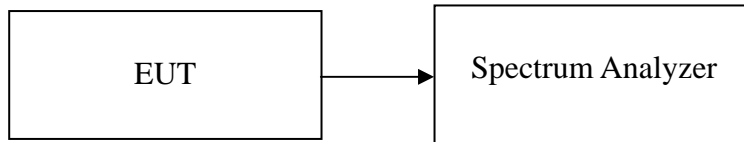

TEST PROCEDURE

1. Place the EUT on the table and set it in the transmitting mode.
2. Remove the antenna from the EUT and then connect a low loss RF cable from the antenna port to the spectrum analyzer.
3. Set the spectrum analyzer as RBW= 5.1kHz, VBW = 10kHz, Span = 500kHz, Sweep = auto.
4. Mark the peak frequency and 20dB (upper and lower) frequency.
5. Repeat until all the rest channels are investigated.

TEST RESULTS

No non-compliance noted.



Test Plot

Agilent 10:57:26 Sep 10, 2013

R T

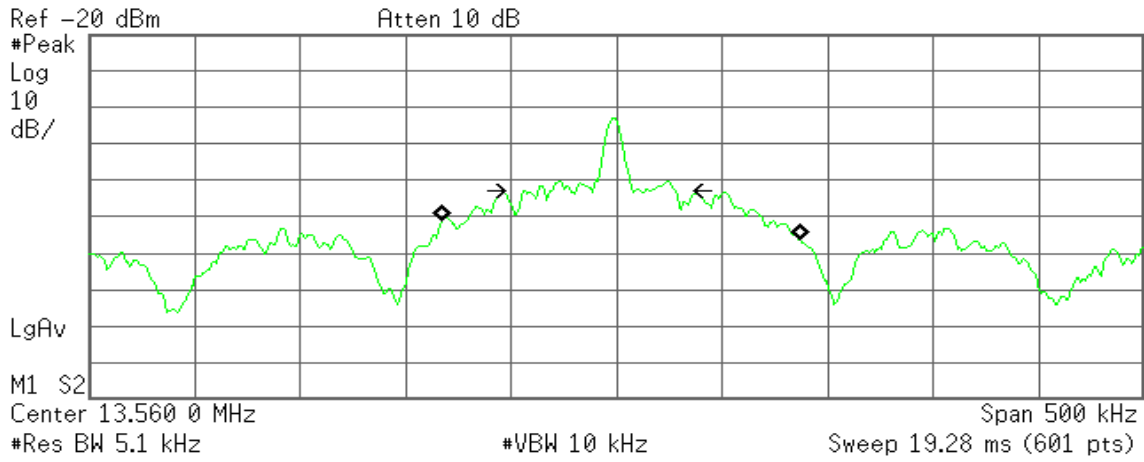

Occupied Bandwidth
170.4351 kHz

Occ BW % Pwr 99.00 %
x dB -20.00 dB

Transmit Freq Error 2.237 kHz
x dB Bandwidth 72.825 kHz



7.2 RADIATED EMISSIONS

LIMIT

According to §15.225,

- (a) The field strength of any emissions within the band 13.553 – 13.567 MHz shall not exceed 15,848 microvolts / meter at 30 meters.
- (b) Within the bands 13.410 – 13.553 MHz and 13.567 -13.710 MHz, the field strength of any emissions shall not exceed 334 microvolts / meter at 30 meters.
- (c) Within the bands 13.110 – 13.410 MHz and 13.710 – 14.010 MHz the field strength of any emissions shall not exceed 106 microvolts / meter at 30 meters.
- (d) The field strength of any emissions appearing outside of the 13.110 – 14.010 MHz and shall not exceed the general radiated emission limits in §15.209.

According to §15.225(a), except as provided elsewhere in this Subpart, the emissions from an intentional radiator shall not exceed the field strength levels specified in the following table:

Frequency (MHz)	Field Strength (μ V/m at meter)	Measurement Distance (meter)
0.009 – 0.490	2400 / F (kHz)	300
0.490 – 1.705	24000 / F (kHz)	30
1.705 – 30.0	30	30
30 - 88	100**	3
88-216	150**	3
216-960	200**	3
Above 960	500	3

** Except as provided in paragraph (g), fundamental emissions from intentional radiators operating under this Section shall not be located in the frequency bands 54-72 MHz, 76-88 MHz, 174-216 MHz or 470-806 MHz. However, operation within these frequency bands is permitted under other sections of this Part, e.g., Sections 15.231 and 15.241.



Test Configuration

9kHz ~ 30MHz

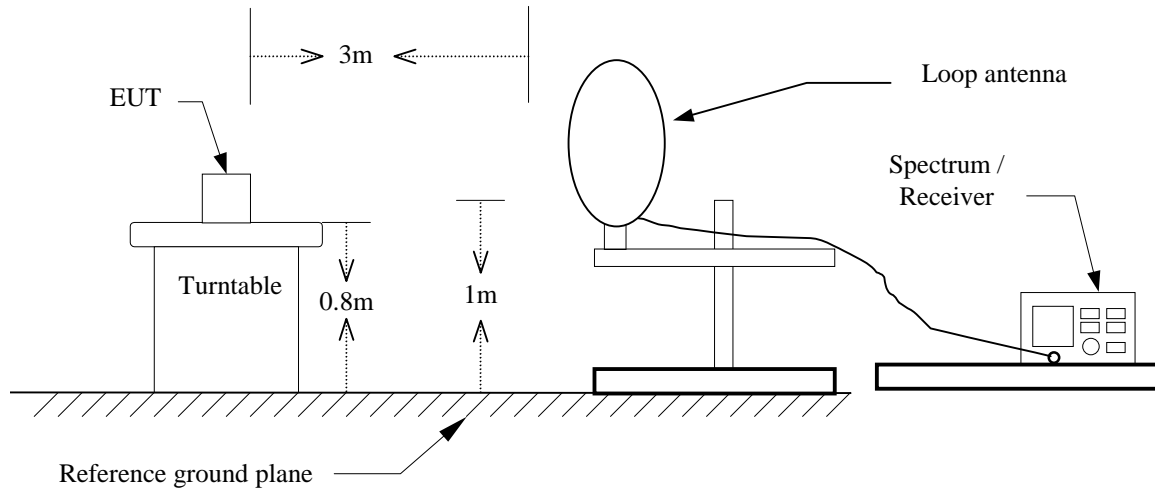

30MHz ~ 1GHz

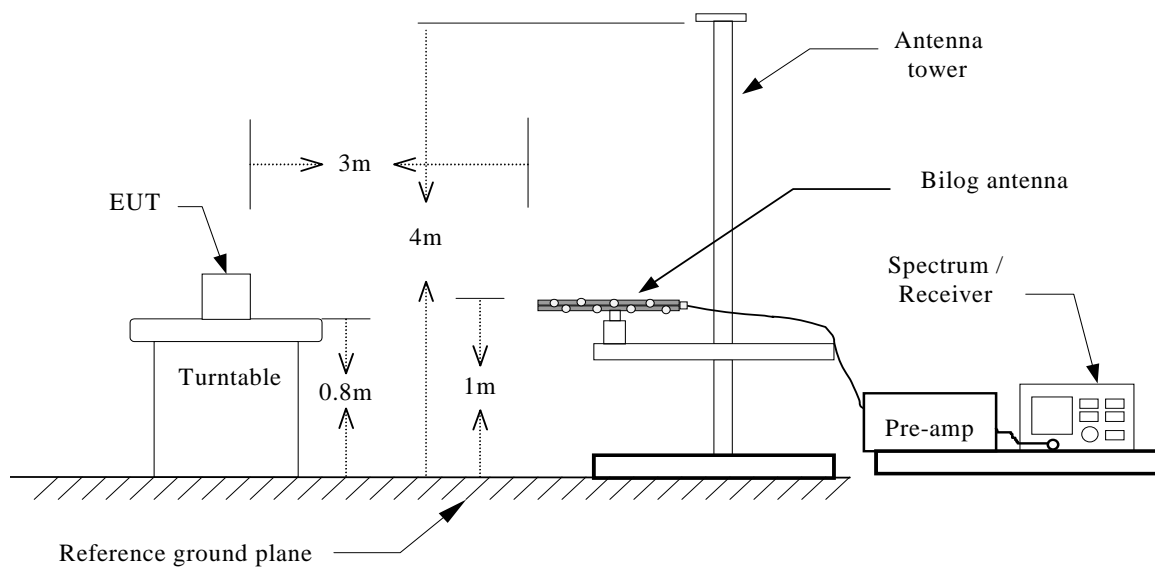



TEST PROCEDURE

For 9kHz ~ 30MHz

1. The EUT is placed on a turntable, which is 0.8m above ground plane.
2. The turntable shall be rotated for 360 degrees to determine the position of maximum emission level.
3. EUT is set 3m away from the receiving antenna, The center of the loop shall be 1 m above the ground then to find out the highest emissions.
4. Maximum procedure was performed on the six highest emissions to ensure EUT compliance.
5. And also, each emission was to be maximized by rotated of receiving antenna axis
6. Set the spectrum analyzer in the following setting as:
RBW=10kHz / VBW=30kHz / Sweep=AUTO
7. Repeat above procedures until the measurements for all frequencies are complete.

For 30MHz ~ 1GHz

1. The EUT is placed on a turntable, which is 0.8m above ground plane.
2. The turntable shall be rotated for 360 degrees to determine the position of maximum emission level.
3. EUT is set 3m away from the receiving antenna, which is varied from 1m to find out the highest emissions.
4. Maximum procedure was performed on the six highest emissions to ensure EUT compliance.
5. And also, each emission was to be maximized by changing the polarization of receiving antenna both horizontal and vertical.
6. Set the spectrum analyzer in the following setting as:
RBW=100kHz / VBW=300kHz / Sweep=AUTO
7. Repeat above procedures until the measurements for all frequencies are complete.



9kHz ~ 30MHz

Operation Mode: TX mode **Test Date:** September 02, 2013
Temperature: 27°C **Tested by:** Rex Huang
Humidity: 53 % RH **Polarity:** Ver. / Hor.

Frequency (MHz)	Detector Mode (PK/QP/AVG)	Reading (dBuV)	Correction Factor (dB/m)	Result (dBuV/m)	Limit 3m (dBuV/m)	Margin (dB)
13.5600	peak	44.21	-68.87	-24.66	60.00	-84.66
0.0656	peak	40.26	-38.32	1.94	21.00	-19.06
0.0741	peak	40.81	-40.75	0.06	18.00	-17.94
0.1044	peak	35.75	-46.21	-10.46	18.00	-28.46
0.1171	peak	33.73	-47.02	-13.29	18.00	-31.29
0.1319	peak	31.45	-47.97	-16.52	18.00	-34.52
0.1366	peak	30.75	-48.27	-17.52	18.00	-35.52
3.7781	peak	22.79	-72.31	-49.52	3.00	-52.52
4.8123	peak	19.37	-72.96	-53.59	0.01	-53.60
5.6003	peak	18.39	-72.79	-54.40	0.01	-54.41
6.8644	peak	30.73	-72.20	-41.47	0.01	-41.48
7.8822	peak	17.46	-71.74	-54.28	0.01	-54.29
9.7373	peak	13.66	-70.92	-57.26	-3.00	-54.26
12.9333	peak	19.88	-69.21	-49.33	-3.50	-45.83
14.4333	peak	19.24	-68.39	-49.15	-3.50	-45.65
19.2000	peak	7.76	-65.37	-57.61	-3.50	-54.11
22.1333	peak	7.35	-63.38	-56.03	-3.50	-52.53
25.4333	peak	7.38	-61.01	-53.63	-3.50	-50.13
28.9000	peak	5.52	-57.94	-52.42	-3.50	-48.92

Remark:

1. Measuring frequencies from 9kHz to the 30MHz.
2. Radiated emissions measured were made with an instrument using peak/quasi-peak/average detector mode.
3. Measurements above show only up to 6 maximum emissions noted, or would be lesser, with " N/A " remark, if no specific emissions from the EUT are recorded (ie: margin>20dB from the applicable limit) and considered that's already beyond the background noise floor.
4. Margin (dB) = Result (dBuV/m) – Limit (dBuV/m).



30MHz ~ 1GHz

Operation Mode:	TX mode	Test Date:	August 18, 2013
Temperature:	26°C	Tested by:	David Shu
Humidity:	60 % RH	Polarity:	Ver. / Hor.

Frequency (MHz)	Detector Mode (PK/QP/AVG)	Reading (dBuV)	Correction Factor (dB/m)	Result (dBuV/m)	Limit 3m (dBuV/m)	Margin (dB)
41.6400	peak	-53.27	-19.03	-72.30	-36.00	-36.30
220.1200	peak	-59.59	-18.94	-78.53	-54.00	-24.53
514.0300	peak	-65.65	-13.43	-79.08	-54.00	-25.08
620.7300	peak	-64.56	-11.76	-76.32	-54.00	-22.32
770.1100	peak	-67.04	-9.68	-76.72	-54.00	-22.72
941.8000	peak	-67.62	-8.23	-75.85	-36.00	-39.85

Remark:

1. *Measuring frequencies from 9kHz to the 1GHz.*
2. *Radiated emissions measured were made with an instrument using peak/quasi-peak/average detector mode.*
3. *Measurements above show only up to 6 maximum emissions noted, or would be lesser, with “ N/A ” remark, if no specific emissions from the EUT are recorded (ie: margin > 20dB from the applicable limit) and considered that's already beyond the background noise floor.*
4. *Margin (dB) = Result (dBuV/m) – Limit (dBuV/m).*



7.3 FREQUENCY STABILITY

LIMIT

According to §15.225(e), the frequency tolerance of the carrier signal shall be maintained within +/- 0.01% of the operating frequency over a temperature variation of -20 degrees to +50 degrees C at normal supply voltage, and for a variation in the primary supply voltage from 85% to 115% of the rated supply voltage at a temperature of 20 degrees C. For battery operated equipment, the equipment tests shall be performed using a new battery.

Test Configuration

Temperature and Voltage Measurement (under normal and extreme test conditions)

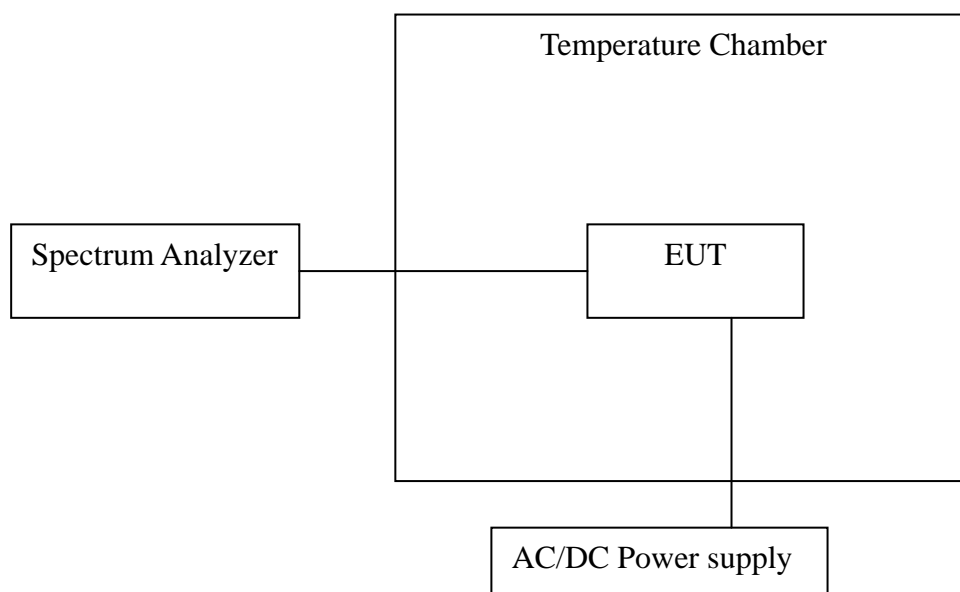

TEST PROCEDURE

1. Place the EUT on the table and set it in the transmitting mode.
2. Remove the antenna from the EUT and then connect a low loss RF cable from the antenna port to the spectrum analyzer.
3. Set the environment into appropriate environment.
4. Set the spectrum analyzer as RBW=1kHz, VBW = RBW, Span = 200kHz, Sweep = auto.
5. Mark the peak frequency and measure the frequency tolerance using frequency counter function.
6. Repeat until all the results are investigated.



TEST RESULTS

No non-compliance noted.

Temperature Variations

Temp. (°C)	Voltage (V)	Measured Frequency (MHz)	Delta Frequency (Hz)	Tolerance (%)	Limit (±%)	Margin (%)	Result (Pass/Fail)
-20	120	13.55892	-1080	-0.00797	0.01	-0.00203	Pass
-10		13.55881	-1190	-0.00878	0.01	-0.01878	Pass
0		13.55869	-1310	-0.00966	0.01	-0.01966	Pass
10		13.55879	-1210	-0.00892	0.01	-0.01892	Pass
20		13.55887	-1130	-0.00833	0.01	-0.01833	Pass
30		13.55897	-1030	-0.00760	0.01	-0.01760	Pass
40		13.55876	-1240	-0.00915	0.01	-0.01915	Pass
50		13.55883	-1170	-0.00863	0.01	-0.01863	Pass

Voltage Variations

Temp. (°C)	Voltage (V)	Measured Frequency (MHz)	Delta Frequency (Hz)	Tolerance (%)	Limit (±%)	Margin (%)	Result (Pass/Fail)
20	108	13.55878	-1221	-0.00901	0.01	-0.00099	Pass
	120	13.55888	-1120	-0.00826	0.01	-0.01826	Pass
	132	13.55896	-1040	-0.00767	0.01	-0.01767	Pass



7.4 POWERLINE CONDUCTED EMISSIONS

LIMIT

According to §15.207(a), except as shown in paragraphs (b) and (c) of this section, for an intentional radiator that is designed to be connected to the public utility (AC) power line, the radio frequency voltage that is conducted back onto the AC power line on any frequency or frequencies within the band 150 kHz to 30 MHz shall not exceed the limits in the following table, as measured using a 50 μ H/50 ohms line impedance stabilization network (LISN). Compliance with the provisions of this paragraph shall be based on the measurement of the radio frequency voltage between each power line and ground at the power terminal. The lower limit applies at the boundary between the frequency ranges.

Frequency Range (MHz)	Limits (dB μ V)	
	Quasi-peak	Average
0.15 to 0.50	66 to 56*	56 to 46*
0.50 to 5	56	46
5 to 30	60	50

* Decreases with the logarithm of the frequency.

TEST PROCEDURE

1. The EUT was placed on a table, which is 0.8m above ground plane.
2. Maximum procedure was performed on the six highest emissions to ensure EUT compliance.
3. Repeat above procedures until all frequency measured were complete.

**TEST RESULTS**

The initial step in collecting conducted data is a spectrum analyzer peak scan of the measurement range. Significant peaks are then marked as shown on the following data page, and these signals are then quasi-peaked.

Operation Mode: Normal Link **Test Date:** August 26, 2013
Temperature: 22°C **Tested by:** Bonny Tsai
Humidity: 55% RH

Freq. (MHz)	Reading (dBuV)	Corr. factor (dB)	Result (dBuV)	Limit (dBuV)	Margin (dB)	Note
0.1500	49.92	10.06	59.98	65.99	-6.01	L1
0.1500	31.29	10.06	41.35	55.99	-14.64	L1
0.1740	45.46	10.06	55.52	64.76	-9.24	L1
0.1740	22.63	10.06	32.69	54.76	-22.07	L1
0.8980	19.32	10.12	29.44	56.00	-26.56	L1
4.3060	17.65	10.33	27.98	56.00	-28.02	L1
13.5580	28.69	10.61	39.30	60.00	-20.70	L1
20.4180	30.22	10.80	41.02	60.00	-18.98	L1
0.1539	50.06	10.04	60.10	65.78	-5.68	L2
0.1539	26.19	10.04	36.23	55.78	-19.55	L2
0.5220	19.87	10.04	29.91	56.00	-26.09	L2
0.8460	18.90	10.08	28.98	56.00	-27.02	L2
3.8780	18.39	10.32	28.71	56.00	-27.29	L2
13.5580	31.07	10.61	41.68	60.00	-18.32	L2
20.3220	30.45	10.80	41.25	60.00	-18.75	L2

Remark:

1. The measuring frequencies range between 0.15 MHz and 30 MHz.
2. The emissions measured in the frequency range between 0.15 MHz and 30MHz were made with an instrument using Quasi-peak detector and Average detector.
3. The IF bandwidth of SPA between 0.15MHz and 30MHz was 10kHz. The IF bandwidth of Test Receiver between 0.15MHz and 30MHz was 9kHz.
4. L1 = Line One (Live Line) / L2 = Line Two (Neutral Line)
5. "-" means Quasi-peak reading value also meets average limit and measurement with the average detector is unnecessary.



Test Plots

Conducted emissions (Line 1)

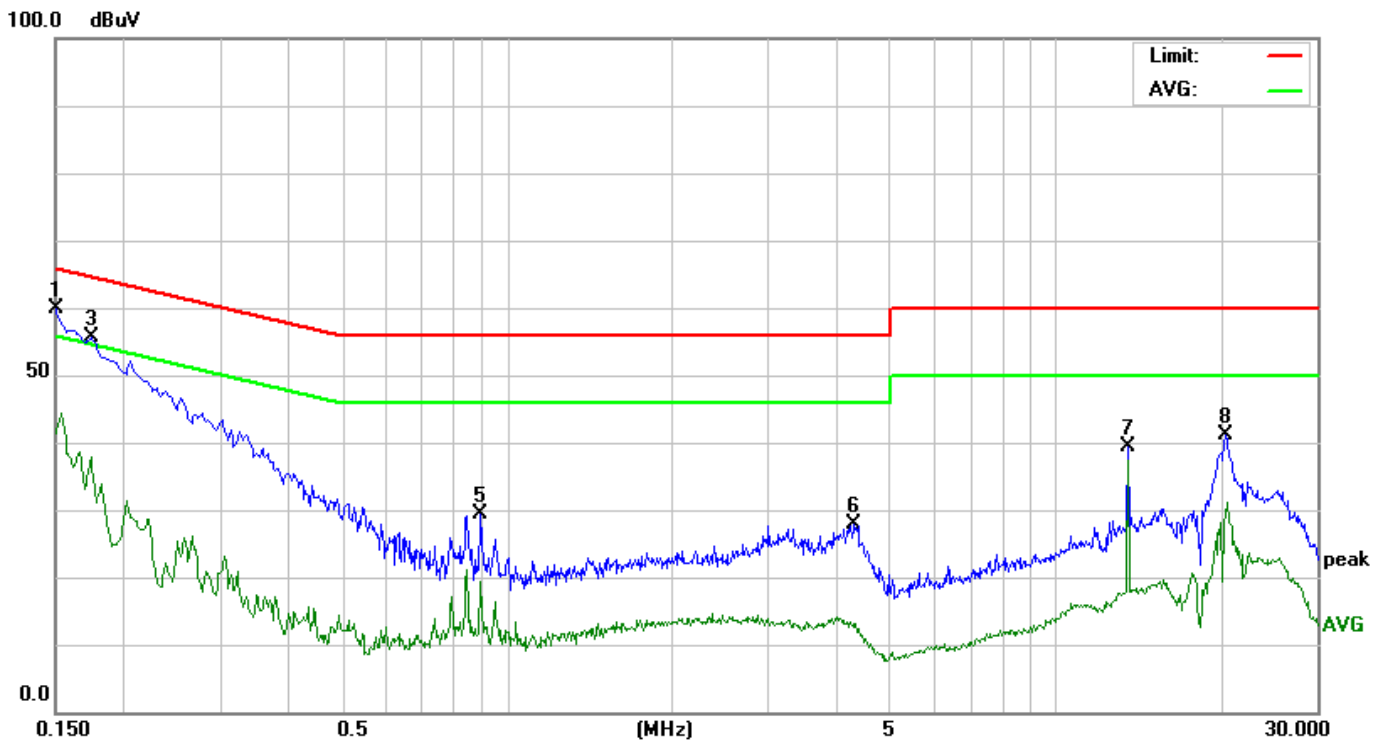

Conducted emissions (Line 2)

