

Product Manual for **SECURE PLUG™**

Contents

1.	Materials in Box	2
2.	Installation	3
3.	Key Whitelist	4
4.	Merchandising	5
5.	Arming & Disarming the System	7
6.	Remerchandising	8
7.	Adding New User Keys	8
8.	Deleting Whitelist	8
9.	LED Status Indicators	9
10.	FCC and ISED Statement	12

DO NOT REMOVE FROM STORE



**For additional support, please reach out to our
Contact Center at 800-426-6844**

Secure Plug Power Strip (Region-Specific)

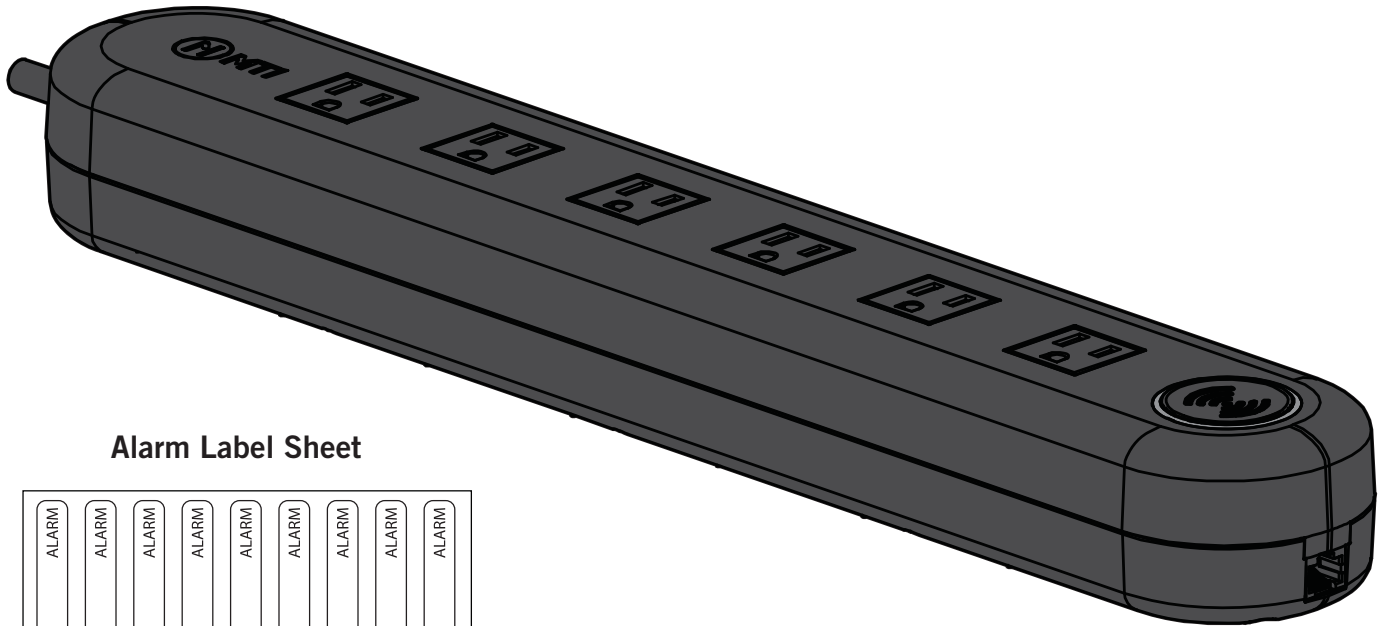

Alarm Label Sheet

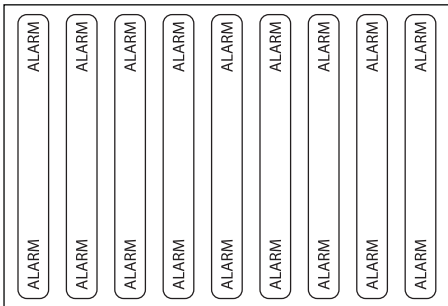

Remote Access Module (Optional)

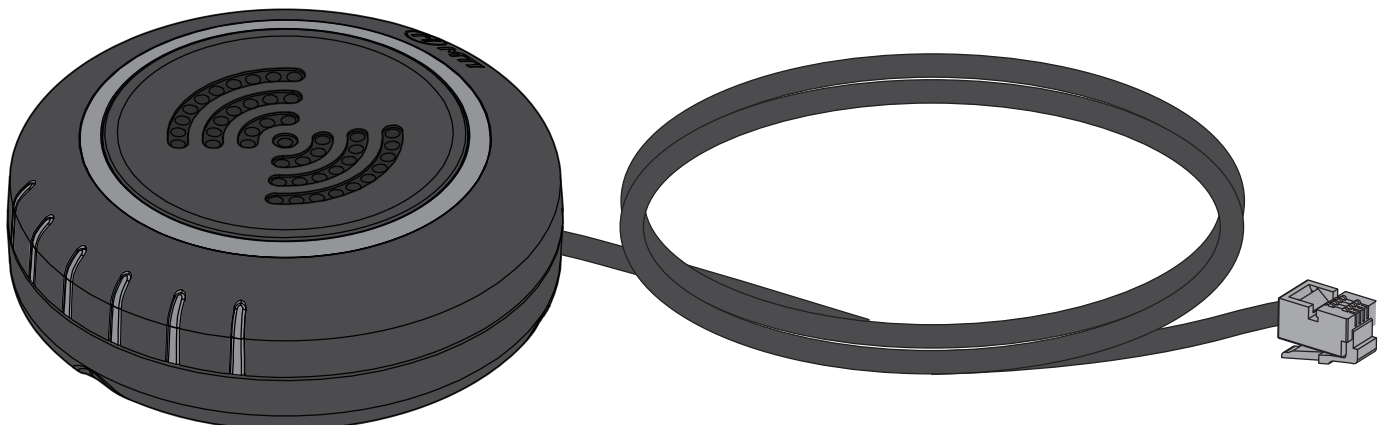



WARNING: No user serviceable parts inside. Please contact MTI for service.

CAUTION: To Reduce the Risk of Electric Shock – Use Only Indoors.

CAUTION: Risk of Electric Shock. Do not plug into another relocatable power tap or an extension cord.

CAUTION: Use Only in Dry Locations.

AVERTISSEMENT: Aucune pièce réparable par l'utilisateur à l'intérieur.
Veuillez contacter MTI pour le service.

ATTENTION: Pour réduire le risque de choc électrique - Utiliser uniquement à l'intérieur.

ATTENTION: Risque de choc électrique. Ne pas brancher sur une autre alimentation ou une rallonge.

ATTENTION: Utiliser uniquement dans des endroits secs.

- 1 FOR SCREW MOUNT (OPTIONAL):** Use three #6 wood screws (not included). Measure and install screws into mounting surface leaving 1/4" of the screw heads exposed. Align the Power Strip keyholes (circled in blue) and hang onto the screws.

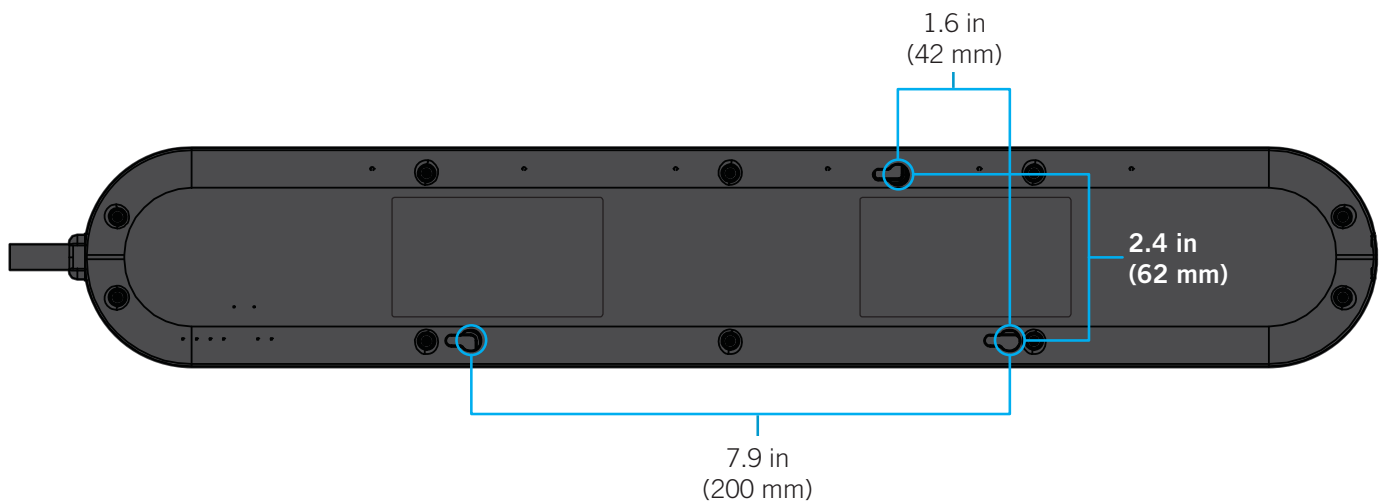

- 2 IF USING THE REMOTE ACCESS MODULE:** Plug in to the end of the Power Strip and affix to surface, if desired.

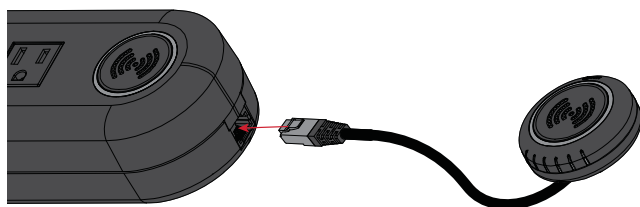

 The Remote Access Module allows you to use the RFID cards to control the Secure Plug when access to the unit is difficult.

- 3** Plug Power Strip into a wall outlet.

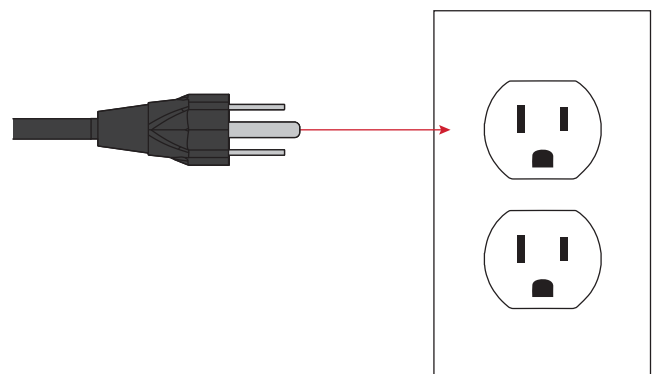

- 1** Place Authorization Card over the RFID icon to register to system. LED will be solid blue.



 **The whitelist process can be done on the Secure Plug unit or through the Remote Access Module.**

- 3** To close the whitelist mode, place the Authorization Card over the RFID icon. Whitelist mode will end automatically after 3 minutes of no use. LED will be flashing white.



- 2** Place the User Key over the RFID icon you want to add.

If successful → unit beeps 2 times
If unsuccessful → unit beeps 4 times (retry)

Repeat process for all User Keys until they are successfully added.



- 1** Unplug any cables from the product end for products that have removable power cords. If the product does not have a removable power cord, turn the power to the product to OFF.

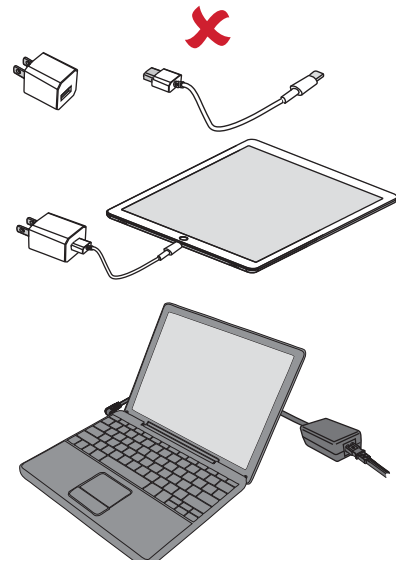
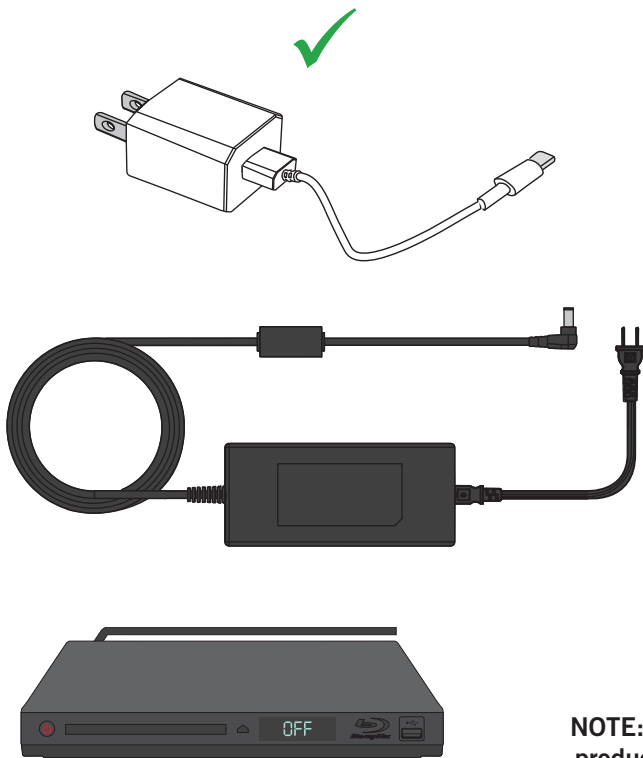

NOTE: Only supports products up to 10A.

- 2** Plug in product cables one at a time to the Power Strip.

If successful → 2 beeps and LED will be solid green, this may take 20 to 60 seconds for products with larger power adapters. The Remote Access Module will show a corresponding white LED for that socket port.

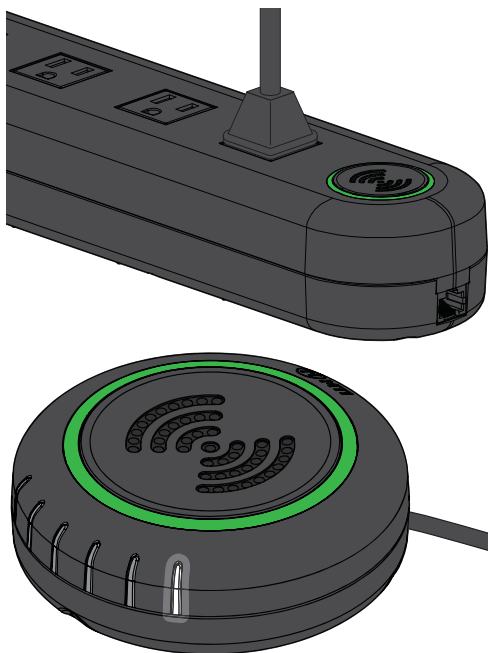

If unsuccessful → unit beeps 4 times and LED will be solid red. The Remote Access Module will show a corresponding red LED for that socket port. Unplug cable from the Power Strip and try again making sure cables are unplugged from the product.

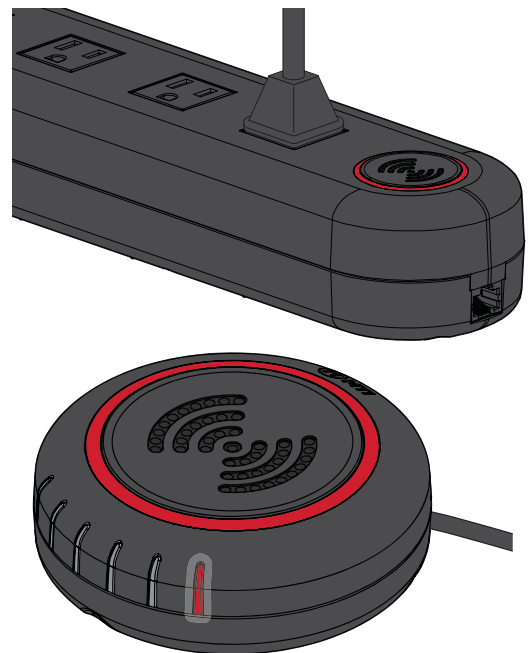

3 Repeat steps with next product to merchandise.

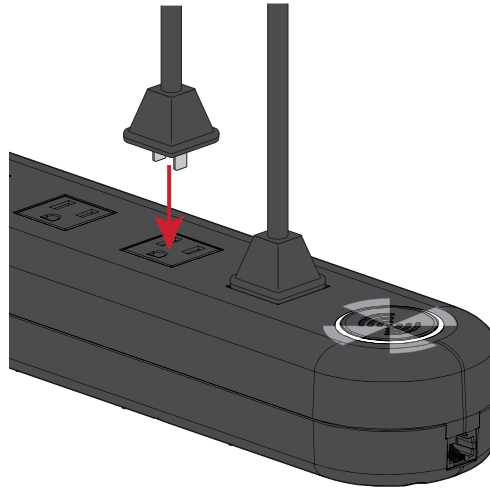

4 When all products have been successfully setup, plug cables back into product end at this time. Apply an "Alarm" label to product end of cable, if desired.

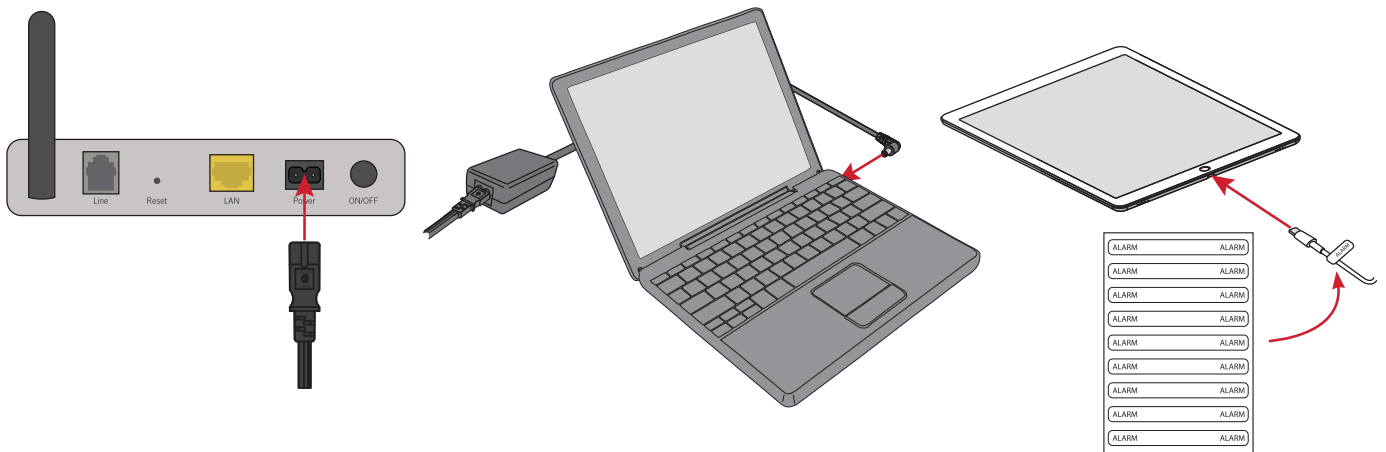

5 Turn the power to products with a detachable power adapter to ON at this time. Keep power to other products OFF (ie. hardwired products or products without power adapters).

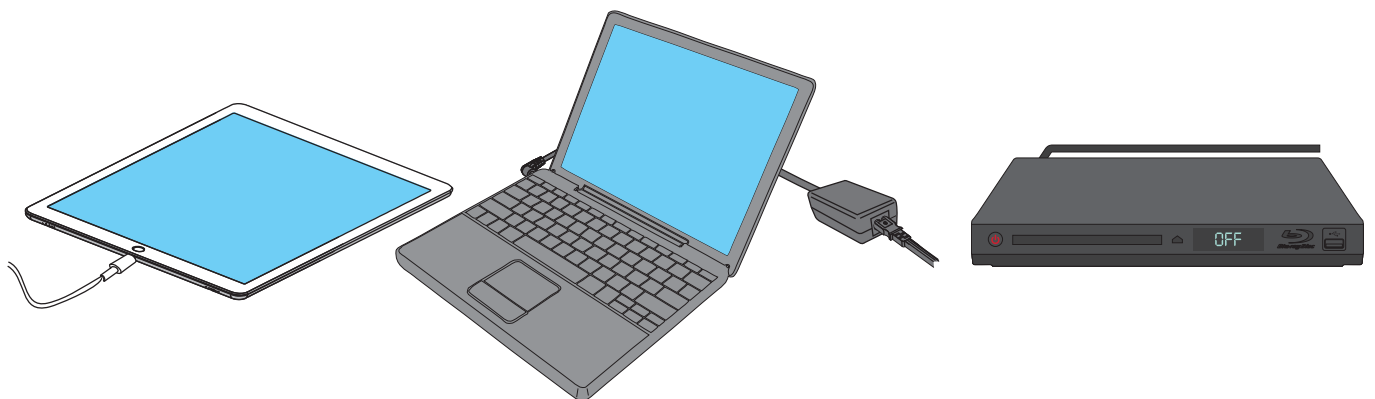

ARMING/DISARMING THE SYSTEM

SECURE PLUG™ (PATENT PENDING) USER GUIDE



- 1** Place any User Key over the RFID icon and the LED will change from flashing white to solid white to indicate Armed.

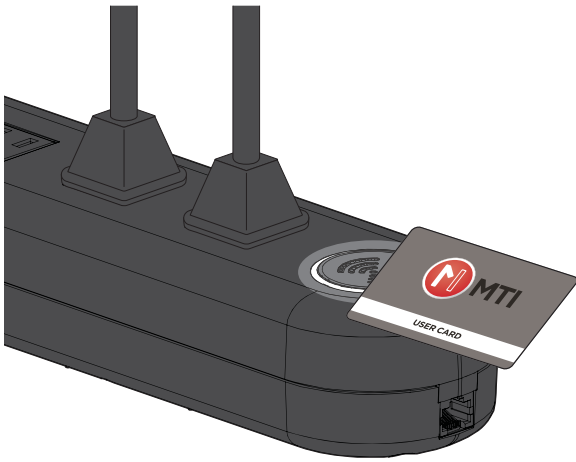

- 2** Turn the power to products to ON or OFF at this time, as desired.

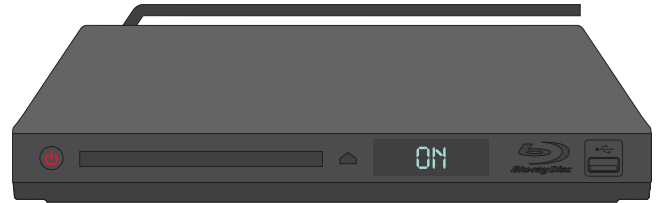

- 3** If any cable becomes unplugged, the system will alarm. LED will flash red/white. The Remote Access Module will show a corresponding red LED for that socket port.

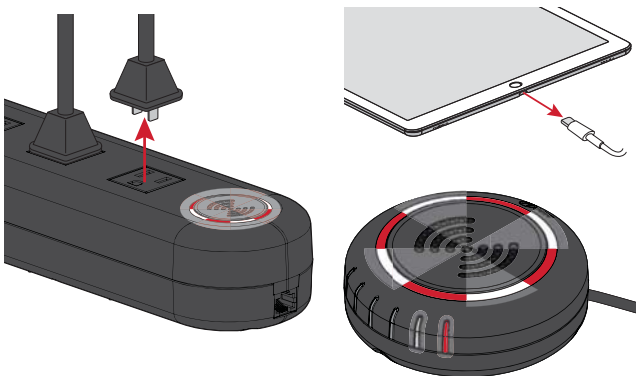

- 4** Placing a User Key over the RFID icon will silence the alarm. The LED will remain flashing red/white.

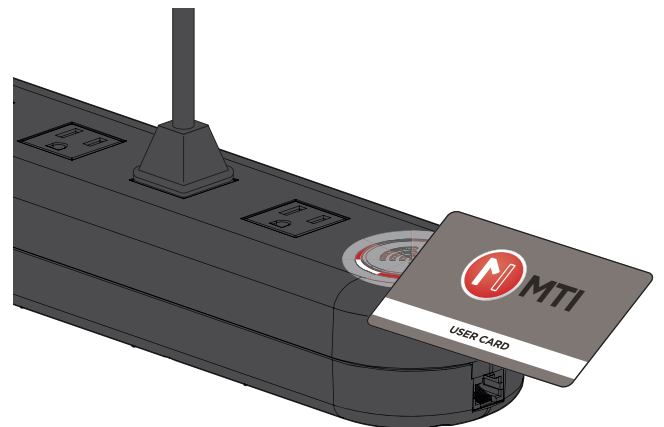

- 5** To re-arm, fix the issue by plugging all cables back in. Place a User Key over the RFID icon and the LED will be solid white.

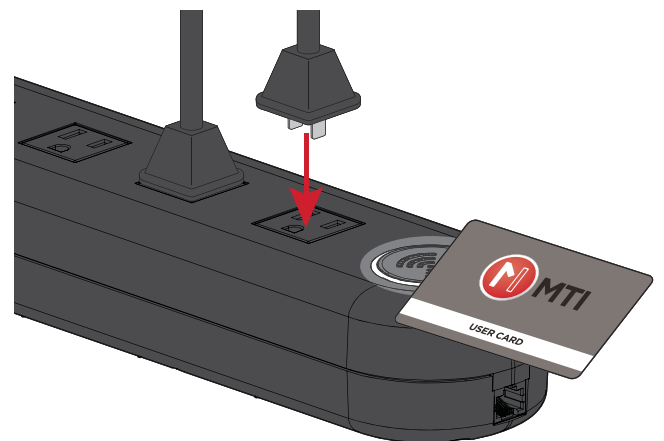
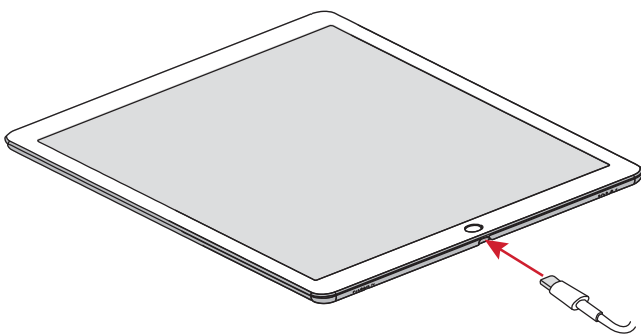

1a From an Armed state, place the User Key over the RFID icon to disarm the system. LED will be flashing white.

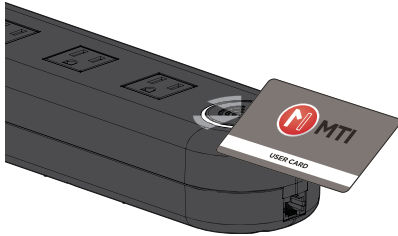

1b From an Alarming state, place the User Key over the RFID icon to silence the alarm. Then hold down the User Key for 5 seconds to return back to the disarmed state. LED will be flashing white.



2 Merchandise a new product by following the process on page 5. If you did not unplug a product, there is no need to remerchandise the product again.



ADDING NEW USER KEYS

1 From an Armed state, place the User Key over the RFID icon to disarm the system. LED will be flashing white.



2 Place Authorization Card over the RFID icon. Follow Key Whitelist process starting on page 4.



DELETING WHITELIST (This will delete all User Keys from the system.)

1 From an Armed state, place the User Key over the RFID icon to disarm the system. LED will be flashing white.



2 Hold down the Authorization Card for 5 seconds, LED will be solid yellow.



3 Place the Authorization Card over the RFID icon AGAIN while LED is yellow.

If successful → unit beeps 2 times and the LED will turn solid green
If unsuccessful → unit beeps 4 times (retry)



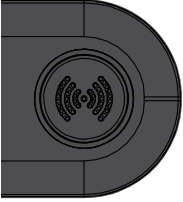
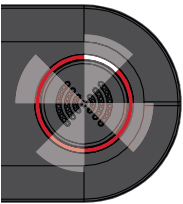
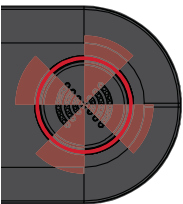
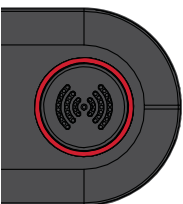

LED STATUS INDICATORS

Visual Reference	System Status	Condition	Solution
	LED is solid white.	Armed	System is armed.
	LED is flashing white.	1. Disarmed 2. Merchandising Calibration	1. System is disarmed and needs to be re-armed. 2. System is calibrating product, wait until successful or unsuccessful merchandising before proceeding.
	LED is flashing red and white.	Alarm	System is alarming and needs to be attended to.
	LED is flashing red.	Mains Power Loss	Mains power loss has occurred. System will alarm for 5 minutes. Whitelist and merchandising information will be maintained upon restoration of power.
	LED is solid red.	Merchandising Unsuccessful	If merchandising fails, unplug the product. Follow merchandising process again.

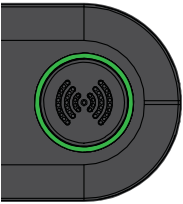
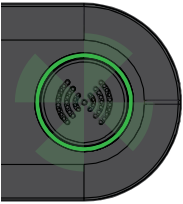
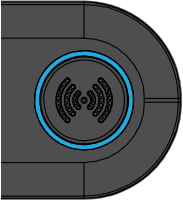
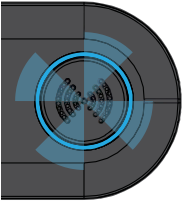
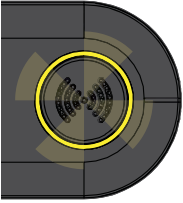
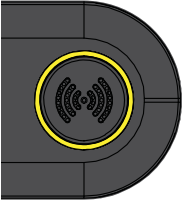
LED STATUS INDICATORS

Visual Reference	System Status	Condition	Solution
	LED is solid green.	Ready to Whitelist	System has an Authorization Card, but does not have any User Keys added. Follow key whitelist process.
	LED is flashing green.	Factory Reset	System has no whitelist or Authorization Card. Follow key whitelist process.
	LED is solid blue.	<ol style="list-style-type: none"> Whitelist Mode (if using Authorization Card) Overcurrent 	<ol style="list-style-type: none"> System is in whitelist enrollment mode. Follow whitelist process to add User Keys. System has gone into overcurrent protection. Unplug any product which may be drawing too much power.
	LED is flashing blue.	Overcurrent/Disarmed	System has gone into overcurrent protection and user has disarmed the system. Unplug any product which may be drawing too much power. The system will self-heal.
	LED is flashing yellow.	<ol style="list-style-type: none"> Ready to be Armed without MTI Connect Mesh Connected Merchandising Calibration without MTI Connect Mesh Connected 	<ol style="list-style-type: none"> Add Secure Plug unit to Mesh network. System is calibrating product, wait until successful or unsuccessful merchandising before proceeding.
	LED is solid yellow.	<ol style="list-style-type: none"> Armed without MTI Connect Mesh Connected Delete Whitelist Mode (If using Authorization Card) 	<ol style="list-style-type: none"> Add Secure Plug unit to Mesh network. System is deleting whitelist. Wait until complete.

LED STATUS INDICATORS

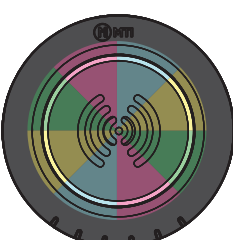
Visual Reference	System Status	Condition	Solution
	<p>Individual LED is solid white (not main LED)</p>	<p>Merchandising successful for that socket port</p>	<p>See main LED for overall system status.</p>
	<p>Individual LED is solid red (not main LED)</p>	<ol style="list-style-type: none"> 1. Merchandising unsuccessful for that socket port 2. Alarm 	<ol style="list-style-type: none"> 1. If merchandising fails, unplug the product. Follow merchandising process again. 2. System is alarming on corresponding socket port and needs to be attended to. <p>See main LED for overall system status</p>
	<p>LED is flashing blue.</p>	<ol style="list-style-type: none"> 1. Provisioning Mode 2. Overcurrent/Disarmed 	<ol style="list-style-type: none"> 1. System has entered Mesh network provisioning mode. If it's within range of a Hub that is also in provisioning mode, it will join the Hub's network within 5 seconds and it will stop flashing blue. 2. System has gone into overcurrent protection and user has disarmed the system. Unplug any product which may be drawing too much power. The system will self-heal.
	<p>LED is flashing multiple colors.</p>	<p>System has received an "identify" command from a user of the MTI Connect software.</p>	

FCC ID: 2AA2X-165-00471
Model: 165-00471
FCC Statement

FCC ID: 2AA2X-165-00645-24
Model: 165-00645 / 165-00670
FCC Statement

This device complies with Part 15 of the FCC Rules.

Caution: If any changes or modifications not expressly approved by the party responsible for compliance could void the user's authority to operate the equipment.

Operation is subject to the following two conditions: (1) This device may not cause harmful interference, and (2) This device must accept any interference received, including interference that may cause undesired operation.

The grantee is not responsible for any changes or modifications not expressly approved by the party responsible for compliance. Such modifications could void the user's authority to operate the equipment.

The RF Exposure Compliance distance is 20 millimeters.

NOTE: This equipment has been tested and found to comply with the limits for a Class B digital device, pursuant to part 15 of the FCC Rules. These limits are designed to provide reasonable protection against harmful interference in a residential installation. This equipment generates, uses and can radiate radio frequency energy and, if not installed and used in accordance with the instructions, may cause harmful interference to radio communications. However, there is no guarantee that interference will not occur in a particular installation. If this equipment does cause harmful interference to radio or television reception, which can be determined by turning the equipment off and on, the user is encouraged to try to correct the interference by one or more of the following measures:

- Reorient or relocate the receiving antenna.
- Increase the separation between the equipment and receiver.
- Connect the equipment into an outlet on a circuit different from that to which the receiver is connected.
- Consult the dealer or an experienced radio/TV technician for help.

ISED Certification Number: 24439-16500471
Model: 165-00471
ISED Statement

ISED Certification Number: 24439-1650064524
Model: 165-00645 / 165-00670
ISED Statement

This device complies with Innovation, Science and Economic Development Canada licence-exempt RSS standard(s). Operation is subject to the following two conditions: (1) this device may not cause interference, and (2) this device must accept any interference, including interference that may cause undesired operation of the device.

CAN ICES-3(B)/NMB-3(B)

Le présent appareil est conforme aux CNR Innovation, Sciences et Développement économique Canada applicables aux appareils radio exempts de licence. L'exploitation est autorisée aux deux conditions suivantes:

(1) il ne doit pas produire de brouillage et (2) l'utilisateur du dispositif doit être prêt à accepter tout brouillage radioélectrique reçu, même si ce brouillage est susceptible de compromettre le fonctionnement du dispositif.

CAN ICES-3(B)/NMB-3(B)

The device meets the exemption from the routine evaluation limits in section 2.5 of RSS 102 and compliance with RSS-102 RF exposure, users can obtain Canadian information on RF exposure and compliance.

Le dispositif rencontre l'exemption des limites courantes d'évaluation dans la section 2.5 de RSS 102 et la conformité à l'exposition de RSS-102 rf, utilisateurs peut obtenir l'information canadienne sur l'exposition et la conformité de rf.

This transmitter must not be co-located or operating in conjunction with any other antenna or transmitter. This equipment should be installed and operated with a minimum distance of 20 millimeters between the radiator and your body.

Cet émetteur ne doit pas être Co-placé ou ne fonctionnant en même temps qu'aucune autre antenne ou émetteur. Cet équipement devrait être installé et actionné avec une distance minimum de 20 millimètres entre le radiateur et votre corps.

Technical Data
Model: 165-00471

Technical Data
Model: 165-00645 / 165-00670

Operating Frequency: 125KHz
 Operating Temperature: 0° C to 40° C
 Max Power: 125KHz: <42dBuA/m at 10m

Operating Frequency: 125KHz, 2.4GHz: 2405-2480MHz
 Operating Temperature: 0° C to 40° C
 Max Power: 125KHz: <42dBuA/m at 10m
 2.4GHz: <20dBm

MTI declares that the radio equipment models 165-00460, 165-00470 and 165-00471 Secure Plug Power distribution units including the models 165-00645 and 165-00670 Remote Access Modules in compliance with EU Directive 2014/53/EU.

The full text of the EU Manufacturer's Declaration of Conformity is available at the following internet address: www.mobiletechinc.com

Mobile Technologies Inc. - 1050 NE 67th Ave, Hillsboro, OR 97124