

FCC - TEST REPORT

Report Number : **60.790.20.080.01R01** Date of Issue : December 22, 2020

Model : **ROUND FREEDOM MICRO II HS**

Product Type : **Merchandise Theft Deterrent System**

Applicant : **Mobile Technologies Inc.**

Address : **1050 NE 67th Ave, Hillsboro, OR 97124, United States Of America**

Production Facility : **Hualun Technology Co., Ltd**

Address : **3F., N. 82-4, Dongshun St., Shulin District, New Taipei City 238, Taiwan.**

Test Result : **Positive** **Negative**

Total pages including Appendices : 44

TÜV SÜD Certification and Testing (China) Co., Ltd. Shenzhen Branch is a subcontractor to TÜV SÜD Product Service GmbH according to the principles outlined in ISO 17025.

TÜV SÜD Certification and Testing (China) Co., Ltd. Shenzhen Branch reports apply only to the specific samples tested under stated test conditions. Construction of the actual test samples has been documented. It is the manufacturer's responsibility to assure that additional production units of this model are manufactured with identical electrical and mechanical components. The manufacturer/importer is responsible to the Competent Authorities in Europe for any modifications made to the production units which result in non-compliance to the relevant regulations. TÜV SÜD Certification and Testing (China) Co., Ltd. Shenzhen Branch shall have no liability for any deductions, inferences or generalizations drawn by the client or others from TÜV SÜD Certification and Testing (China) Co., Ltd. Shenzhen Branch issued reports.

This report is the confidential property of the client. As a mutual protection to our clients, the public and ourselves, extracts from the test report shall not be reproduced except in full without our written approval

1 Table of Contents

1 Table of Contents	2
2 Description of Equipment Under Test.....	3
3 Summary of Test Standards.....	4
4 Details about the Test Laboratory	5
4.1 Test Equipment Site List	6
4.2 Measurement System Uncertainty	7
5 Summary of Test Results	8
6 General Remarks	9
7 Test Setups	10
7.1 Radiated test setups Below 1GHz	10
7.2 Radiated test setups Above 1GHz.....	10
7.3 AC Power Line Conducted Emission test setups.....	11
7.4 Conducted RF test setups.....	11
8 Emission Test Results	12
8.1 Spurious Radiated Emission	12
8.2 Conducted Emission at AC Power line	16
8.3 6dB & 99% Bandwidth	18
8.4 Peak Output Power	21
8.5 Spurious Emissions at Antenna Terminals	24
8.6 100kHz Bandwidth of band edges	30
8.7 Power Spectral Density	32
8.8 Antenna Requirement	35
9 Test setup procedure.....	36
10 Appendix A - General Product Information.....	44

2 Description of Equipment Under Test

Description of the Equipment Under Test

Product: Merchandise Theft Deterrent System

Model no.: ROUND FREEDOM MICRO II HS

FCC ID: 2AA2X-15000282

Rating: Adapter Model:W&T-AD36W059350F
 Input: AC100-240V. 1.0A
 Output: DC 5.9V, 3.5A

Main unit input: DC 5.9V, 3.5A
 Main unit outout(USB type-C):DC5.2V, 3.0A

Internal rechargeable battery: DC3.7V, type LIR2302H

Frequency: 2405MHz-2480MHz (Tx and Rx)

Antenna gain: 0 dBi

Number of operated channel: 16

Modulation: O-QPSK

Auxiliary Equipment and Software Used during Test:

DESCRIPTION	MANUFACTURER	MODEL NO.	S/N
/	/	/	/

Auxiliary Software Used during Test:

DESCRIPTION	SOFTWARE NAME	VERSION	REMARK
/	/	/	/

3 Summary of Test Standards

Test Standards

FCC Part 15 Subpart C 10-1-20 Edition Federal Communications Commission, PART 15 — Radio Frequency Devices, Subpart C —Intentional Radiators
--

All the test methods were according to KDB558074 D01 v05r02 DTS Measurement Guidance and ANSI C63.10 (2013).

4 Details about the Test Laboratory

Site 1

Company name: TÜV SÜD Certification and Testing (China) Co., Ltd. Shenzhen Branch
 Building 12&13 Zhiheng Wisdomland Business Park,
 Nantou Checkpoint Road 2,
 Shenzhen 518052, P.R.China
 FCC Registration Number: 514049
 ISED test site number: 10320A

Emission Tests	
Test Item	Test Site
FCC Part 15 Subpart C	
FCC Title 47 Part 15.205, 15.209 & 15.247(d) Spurious Radiated Emission	Site 1
FCC Title 47 Part 15.207 Conduct Emission	Site 1
FCC Title 47 Part 15.247(a)(1) 6dB & 99% Bandwidth	Site 1
FCC Title 47 Part 15.247(b) Peak Output Power	Site 1
FCC Title 47 Part 2.1051 & 15.247(d) Spurious Emissions at Antenna Terminals	Site 1
FCC Title 47 Part 15.247(d) 100kHz Bandwidth of band edges	Site 1
FCC Title 47 Part 15.247(e) Power Spectral Density	Site 1
FCC Title 47 Part 15.203 & 15.247(b) Antenna Requirement	Site 1

4.1 Test Equipment Site List

Radiated emission Test – Site 1

DESCRIPTION	MANUFACTURER	MODEL NO.	SERIAL NO.	CAL. DUE DATE
EMI Test Receiver	Rohde & Schwarz	ESR 26	101269	2021-6-29
Signal Analyzer	Rohde & Schwarz	FSV40	101031	2021-6-22
Loop Antenna	Rohde & Schwarz	HFH2-Z2	100398	2021-7-7
Trilog Super Broadband Test Antenna	Schwarzbeck	VULB 9163	707	2021-8-4
Horn Antenna	Rohde & Schwarz	HF907	102294	2021-7-5
Wideband Horn Antenna	Q-PAR	QWH-SL-18-40-K-SG	12827	2021-6-21
Pre-amplifier	Rohde & Schwarz	SCU 18	102230	2021-6-21
Pre-amplifier	Rohde & Schwarz	SCU 40A	100432	2021-7-30
Attenuator	Agilent	8491A	MY39264334	2021-6-21
3m Semi-anechoic chamber	TDK	9X6X6	----	2022-10-28
Test software	Rohde & Schwarz	EMC32	Version 9.15.00	N/A

Conducted Emission Test – Site 1

DESCRIPTION	MANUFACTURER	MODEL NO.	SERIAL NO.	CAL. DUE DATE
EMI Test Receiver	Rohde & Schwarz	ESR 3	101782	2021-6-29
LISN	Rohde & Schwarz	ENV4200	100249	2021-6-12
LISN	Rohde & Schwarz	ENV432	101318	2021-6-12
LISN	Rohde & Schwarz	ENV216	100326	2021-6-12
LISN	Rohde & Schwarz	ENV216	102472	2021-6-12
ISN	Rohde & Schwarz	ENY81	100177	2021-6-12
ISN	Rohde & Schwarz	ENY81-CA6	101664	2021-6-12
High Voltage Probe	Schwarzbeck	TK9420(VT9420)	9420-584	2021-6-23
RF Current Probe	Rohde & Schwarz	EZ-17	100816	2021-6-28
Attenuator	Shanghai Huaxiang	TS2-26-3	080928189	2021-6-21
Test software	Rohde & Schwarz	EMC32	Version9.15.00	N/A
Shielding Room	TDK	CSR #1	----	2020-11-07

20dB & 99% Bandwidth, Peak Output Power, Spurious Emissions at Antenna Terminals, 100kHz Bandwidth of band edges, Power Spectral Density – Site 1

DESCRIPTION	MANUFACTURER	MODEL NO.	SERIAL NO.	CAL. DUE DATE
Signal Analyzer	Rohde & Schwarz	FSV40	101030	2021-6-21
RF Switch Module	Rohde & Schwarz	OSP120/OSP-B157	101226/100851	2021-6-21

4.2 Measurement System Uncertainty

Measurement System Uncertainty Emissions

System Measurement Uncertainty	
Items	Extended Uncertainty
Uncertainty for Radiated Emission in 3m chamber 9kHz-30MHz	4.76dB
Uncertainty for Radiated Emission in 3m chamber 30MHz-1000MHz	Horizontal: 5.12dB; Vertical: 5.10dB;
Uncertainty for Radiated Emission in 3m chamber 1000MHz-25000MHz	Horizontal: 5.01dB; Vertical: 5.00dB;
Uncertainty for Conducted Emission at AC Power Line 150kHz-30MHz	3.21dB
Uncertainty for conducted power test	1.16dB
Uncertainty for frequency test	0.6×10^{-7}

5 Summary of Test Results

Emission Tests				
FCC Part 15 Subpart C				
Test Condition	Pages	Test Result		
		Pass	Fail	N/A
FCC Title 47 Part 15.205, 15.209 & 15.247(d) Spurious Radiated Emission	12-15	<input checked="" type="checkbox"/>	<input type="checkbox"/>	<input type="checkbox"/>
FCC Title 47 Part 15.207 Conduct Emission	16-17	<input checked="" type="checkbox"/>	<input type="checkbox"/>	<input type="checkbox"/>
FCC Title 47 Part 15.247(a)(2) 6dB & 99% Bandwidth	18-20	<input checked="" type="checkbox"/>	<input type="checkbox"/>	<input type="checkbox"/>
FCC Title 47 Part 15.247(b) Peak Output Power	21-23	<input checked="" type="checkbox"/>	<input type="checkbox"/>	<input type="checkbox"/>
FCC Title 47 Part 2.1051 & 15.247(d) Spurious Emissions at Antenna Terminals	24-29	<input checked="" type="checkbox"/>	<input type="checkbox"/>	<input type="checkbox"/>
FCC Title 47 Part 15.247(d) 100kHz Bandwidth of band edges	30-31	<input checked="" type="checkbox"/>	<input type="checkbox"/>	<input type="checkbox"/>
FCC Title 47 Part 15.247(e) Power Spectral Density	32-34	<input checked="" type="checkbox"/>	<input type="checkbox"/>	<input type="checkbox"/>
FCC Title 47 Part 15.203 & 15.247(b) Antenna Requirement	35	<input checked="" type="checkbox"/>	<input type="checkbox"/>	<input type="checkbox"/>

6 General Remarks

Remarks

This submittal(s) (test report) is intended for **FCC ID: 2AA2X-15000282**, complies with Section 15.203, 15.205, 15.207, 15.209, 15.247 of the FCC Part 15, Subpart C rules for the DTS grant.

The TX and RX range is 2405MHz-2480MHz.

The 3.7V battery is a backup in case the product is removed from its AC/DC adapter. Normally the product is fixed and connected to the adapter, therefore, all RF test results on this report are based on this case with the adapter. However, we have checked the result on 3.7V, no obvious difference.

SUMMARY:

- All tests according to the regulations cited on page 8 were

■ - Performed

□ - **Not** Performed

- The Equipment Under Test

■ - **Fulfills** the general approval requirements.

□ - **Does not** fulfill the general approval requirements.

Sample Received Date: November 9, 2020

Testing Start Date: November 13, 2020

Testing End Date: December 22, 2020

- TÜV SÜD Certification and Testing (China) Co., Ltd. Shenzhen Branch -

Reviewed by:

Prepared by:

Tested by:



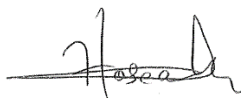



Eric LI
EMC Project Manager

Hosea CHAN
EMC Project Engineer

Louise Liu
EMC Test Engineer

7 Test Setups

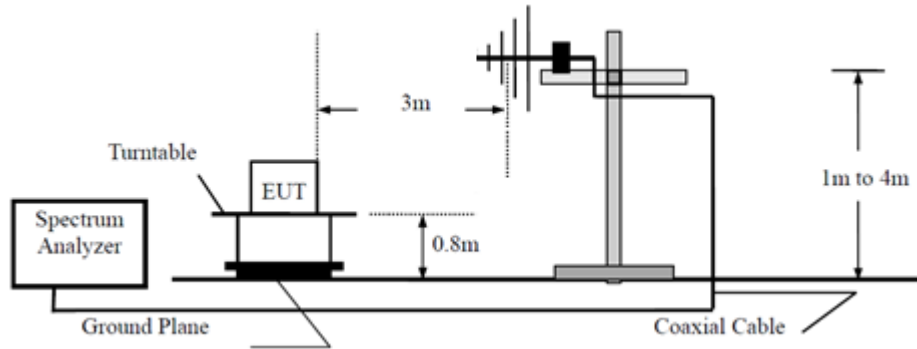
7.1 Radiated test setups Below 1GHz



7.2 Radiated test setups Above 1GHz

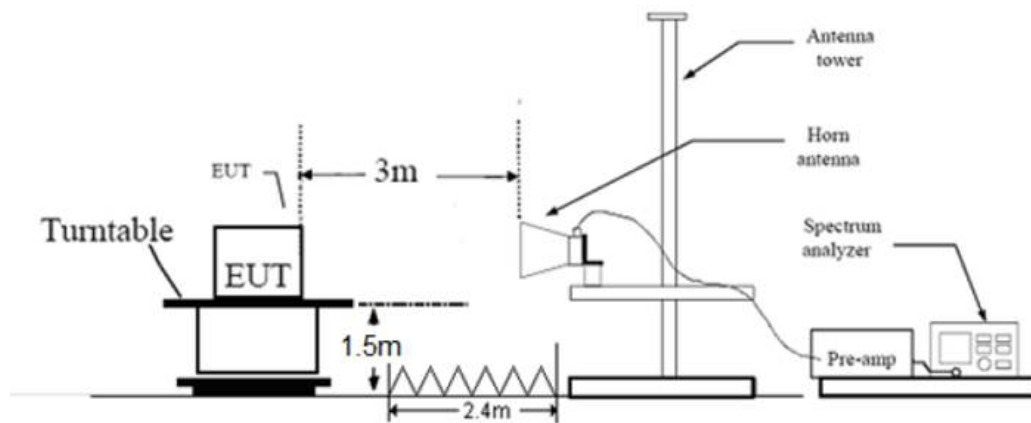

7.3 AC Power Line Conducted Emission test setups

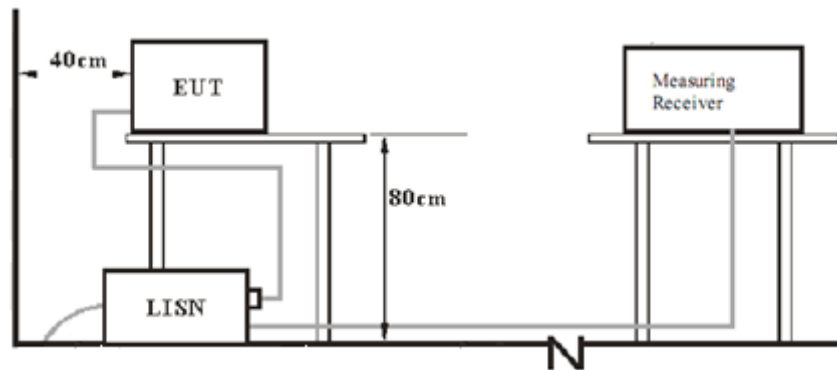

7.4 Conducted RF test setups

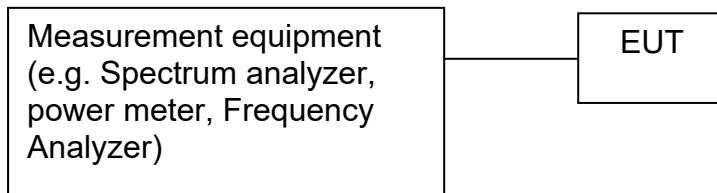

8 Emission Test Results

8.1 Spurious Radiated Emission

EUT: ROUND FREEDOM MICRO II HS
 Op Condition: Operated, TX Mode
 (Lowest channel is the worst case)
 Test Specification: FCC15.205, 15.209 & 15.247(d)
 Comment: 120V AC, 60Hz
 Remark: Below 1GHz

Test Result	
<input checked="" type="checkbox"/>	Passed
<input type="checkbox"/>	Not Passed

Frequency MHz	Result dB μ V/m	Limit dB μ V/m	Over Limit dB	Detector PK/QP/AV	Ant. Polarity H/V	Corr. (dB)
69.608333	32.99	40.00	-7.01	Peak	H	11.08
70.632222	32.61	40.00	-7.39	Peak	H	10.78
123.928333	26.23	43.50	-17.27	Peak	H	10.29
158.147778	32.60	43.50	-10.90	Peak	H	9.68
309.791111	34.70	46.00	-11.30	Peak	H	15.03
441.118333	31.26	46.00	-14.74	Peak	H	18.17
74.889444	35.60	40.00	-4.40	Peak	V	9.47
91.972222	34.70	43.50	-8.80	Peak	V	11.18
159.764444	38.26	43.50	-5.24	Peak	V	9.74
202.067222	34.11	43.50	-9.39	Peak	V	12.74
312.755000	30.96	46.00	-15.04	Peak	V	15.12
445.052222	29.36	46.00	-16.64	Peak	V	18.24

Remark:

- As the measured peak value not exceeded the Quasi-peak limit, Quasi-peak value no need to be measured.
- Result Level=Reading Level + Correction Factor
 Above 1GHz: Corrector factor = Antenna Factor + Cable Loss- Amplifier Gain
 Below 1GHz: Corrector factor = Antenna Factor + Cable Loss
 (The Reading Level is recorded by software which is not shown in the sheet)

Spurious Radiated Emission

EUT: ROUND FREEDOM MICRO II HS
 Op Condition: Operated, TX Mode (2405MHz)
 Test Specification: FCC15.205, 15.209 & 15.247(d)
 Comment: 120V AC, 60Hz
 Remark: 1GHz to 25GHz

Test Result	
<input checked="" type="checkbox"/>	Passed
<input type="checkbox"/>	Not Passed

Frequency MHz	Result dBµV/m	Limit dBµV/m	Over Limit dB	Detector PK/QP/AV	Ant. Polarity H/V	Corr. (dB)
2613.000000	43.53	74.00	-30.47	Peak	H	-2.53
3531.000000	45.85	74.00	-28.15	Peak	H	-0.16
5571.500000	50.66	74.00	-23.34	Peak	H	4.42
16610.500000	47.39	74.00	-26.61	Peak	H	15.78
1766.000000	42.06	74.00	-31.94	Peak	V	-5.94
4328.500000	46.45	74.00	-27.55	Peak	V	2.04
5883.000000	49.94	74.00	-24.06	Peak	V	5.57
10950.500000	42.95	74.00	-31.05	Peak	V	8.46

Remark:

1. According to C63.10, if the peak (or quasi-peak) measured value complies with the average limit, it is unnecessary to perform an average measurement, so AV emission value did not show in data table if the peak value complies with average limit.
2. Consequence Level=Reading Level + Correction Factor
 Above 1GHz: Corrector factor = Antenna Factor + Cable Loss- Amplifier Gain
 Below 1GHz: Corrector factor = Antenna Factor + Cable Loss
 (The Reading Level is recorded by software which is not shown in the sheet)

Spurious Radiated Emission

EUT: ROUND FREEDOM MICRO II HS
 Op Condition: Operated, TX Mode (2445MHz)
 Test Specification: FCC15.205, 15.209 & 15.247(d)
 Comment: 120V AC, 60Hz
 Remark: 1GHz to 25GHz

Test Result	
<input checked="" type="checkbox"/>	Passed
<input type="checkbox"/>	Not Passed

Frequency MHz	Result dBµV/m	Limit dBµV/m	Over Limit dB	Detector PK/QP/AV	Ant. Polarity H/V	Corr. (dB)
2679.000000	42.98	74.00	-31.02	Peak	H	-2.38
4007.000000	46.69	74.00	-27.31	Peak	H	1.36
5491.500000	50.15	74.00	-23.85	Peak	H	4.42
10306.000000	43.87	74.00	-30.13	Peak	H	8.85
3312.500000	45.83	74.00	-28.17	Peak	V	-0.64
4779.000000	47.42	74.00	-26.58	Peak	V	2.68
5791.000000	49.71	74.00	-24.29	Peak	V	5.17
12768.000000	45.74	74.00	-28.26	Peak	V	9.40

Remark:

1. According to C63.10, if the peak (or quasi-peak) measured value complies with the average limit, it is unnecessary to perform an average measurement, so AV emission value did not show in data table if the peak value complies with average limit.
2. Consequence Level=Reading Level + Correction Factor
 Above 1GHz: Corrector factor = Antenna Factor + Cable Loss- Amplifier Gain
 Below 1GHz: Corrector factor = Antenna Factor + Cable Loss
 (The Reading Level is recorded by software which is not shown in the sheet)

Spurious Radiated Emission

EUT: ROUND FREEDOM MICRO II HS
 Op Condition: Operated, TX Mode (2480MHz)
 Test Specification: FCC15.205, 15.209 & 15.247(d)
 Comment: 120V AC, 60Hz
 Remark: 1GHz to 25GHz

Test Result	
<input checked="" type="checkbox"/>	Passed
<input type="checkbox"/>	Not Passed

Frequency MHz	Result dBµV/m	Limit dBµV/m	Over Limit dB	Detector PK/QP/AV	Ant. Polarity H/V	Corr. (dB)
2443.000000	42.95	74.00	-31.05	Peak	H	-3.08
4009.500000	45.56	74.00	-28.44	Peak	H	1.36
5964.500000	50.07	74.00	-23.93	Peak	H	5.46
12942.500000	45.56	74.00	-28.44	Peak	H	9.25
2780.000000	44.26	74.00	-29.74	Peak	H	-2.11
4133.000000	46.30	74.00	-27.70	Peak	H	1.73
5666.500000	49.79	74.00	-24.21	Peak	V	4.68
8261.500000	41.53	74.00	-32.47	Peak	V	6.27

Remark:

1. According to C63.10, if the peak (or quasi-peak) measured value complies with the average limit, it is unnecessary to perform an average measurement, so AV emission value did not show in data table if the peak value complies with average limit.
2. Consequence Level=Reading Level + Correction Factor
 Above 1GHz: Corrector factor = Antenna Factor + Cable Loss- Amplifier Gain
 Below 1GHz: Corrector factor = Antenna Factor + Cable Loss
 (The Reading Level is recorded by software which is not shown in the sheet)

8.2 Conducted Emission at AC Power line

EUT: ROUND FREEDOM MICRO II HS
 Op Condition: 2.4G Link and charging battery
 Test Specification: AC Mains, L Line
 Comment: 120V AC, 60Hz

Test Result	
<input checked="" type="checkbox"/>	Passed
<input type="checkbox"/>	Not Passed

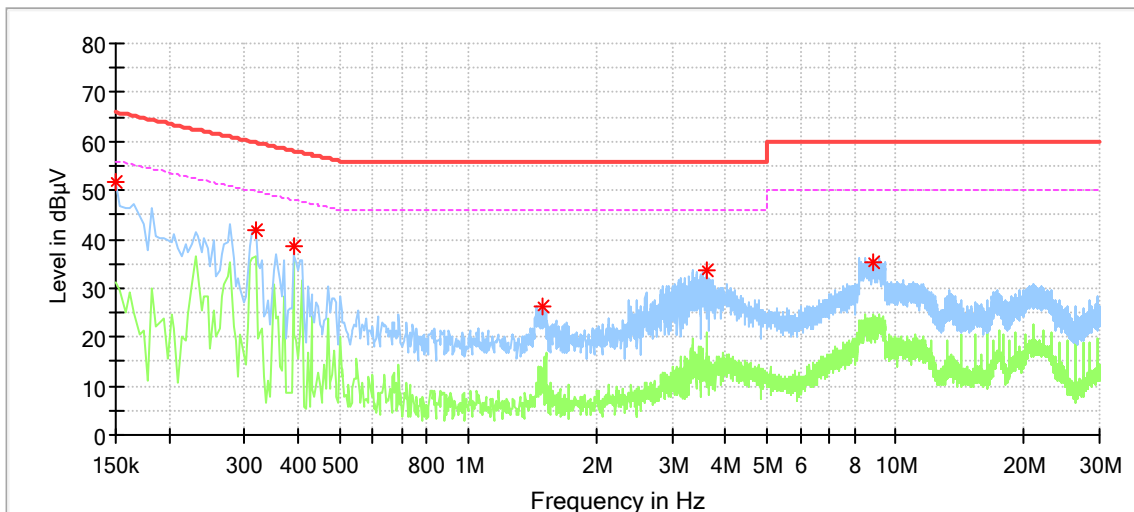

Frequency (MHz)	MaxPeak (dBµV)	Average (dBµV)	Limit (dBµV)	Margin (dB)
0.150000	51.67	---	66.00	-14.33
0.318000	42.03	---	59.76	-17.73
0.390000	38.68	---	58.06	-19.38
1.486000	26.15	---	56.00	-29.85
3.618000	33.51	---	56.00	-22.49
8.874000	35.47	---	60.00	-24.53

Conducted Emission Test

EUT: ROUND FREEDOM MICRO II HS
 Op Condition: 2.4G Link and charging battery
 Test Specification: AC Mains, N Line
 Comment: 120V AC, 60Hz

Test Result	
<input checked="" type="checkbox"/>	Passed
<input type="checkbox"/>	Not Passed

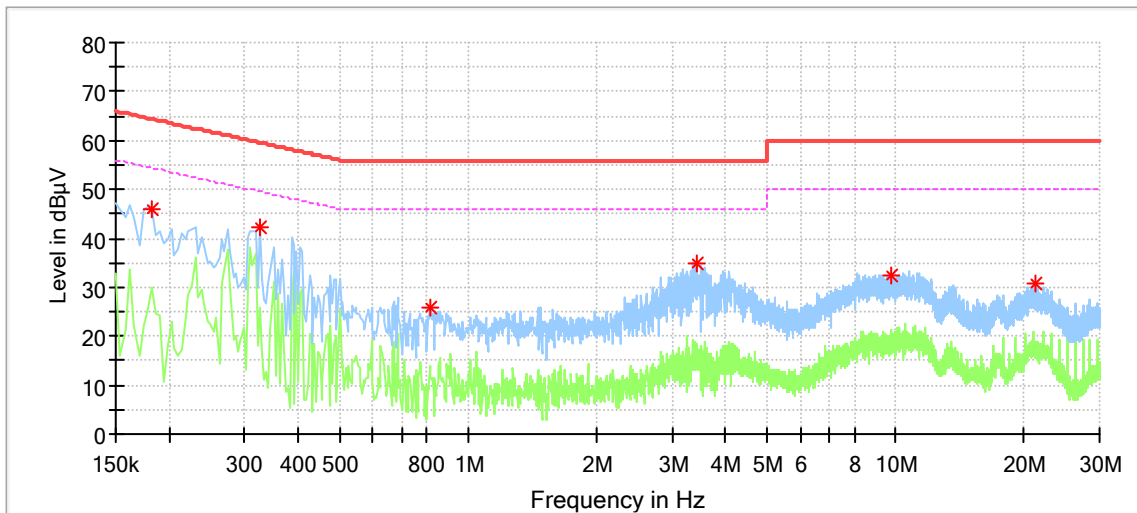

Frequency (MHz)	MaxPeak (dBµV)	Average (dBµV)	Limit (dBµV)	Margin (dB)
0.182000	45.93	---	64.39	-18.47
0.326000	42.26	---	59.55	-17.29
0.814000	25.76	---	56.00	-30.24
3.442000	35.02	---	56.00	-20.98
9.758000	32.34	---	60.00	-27.66
21.222000	30.81	---	60.00	-29.19

8.3 6dB & 99% Bandwidth

EUT: ROUND FREEDOM MICRO II HS
 Op Condition: Operated, TX Mode (2405MHz)
 Test Specification: FCC15.247(a)(2), 6dB Bandwidth & 99% Bandwidth
 Comment: 120V AC, 60Hz

Test Result	
<input checked="" type="checkbox"/>	Passed
<input type="checkbox"/>	Not Passed

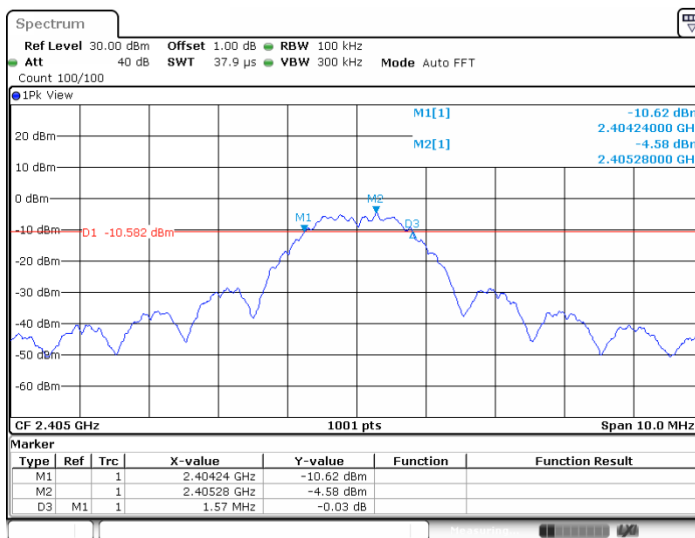

Date: 24.NOV.2020 14:48:55

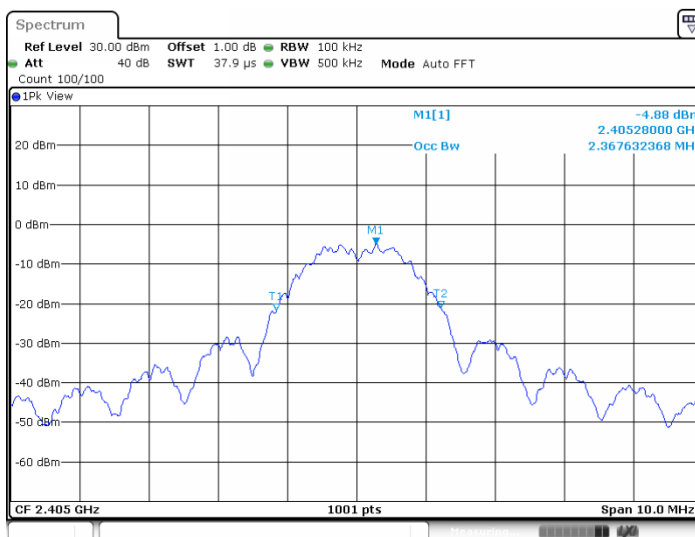

Date: 24.NOV.2020 14:49:05

Bandwidth	Measured Value	Limit
6dB bandwidth	1.570 MHz	> 0.5MHz
99% OCB	2.368 MHz	NA

6dB & 99% Bandwidth

EUT: ROUND FREEDOM MICRO II HS
 Op Condition: Operated, TX Mode (2445MHz)
 Test Specification: FCC15.247(a)(2), 6dB Bandwidth & 99% Bandwidth
 Comment: 120V AC, 60Hz

Test Result	
<input checked="" type="checkbox"/>	Passed
<input type="checkbox"/>	Not Passed

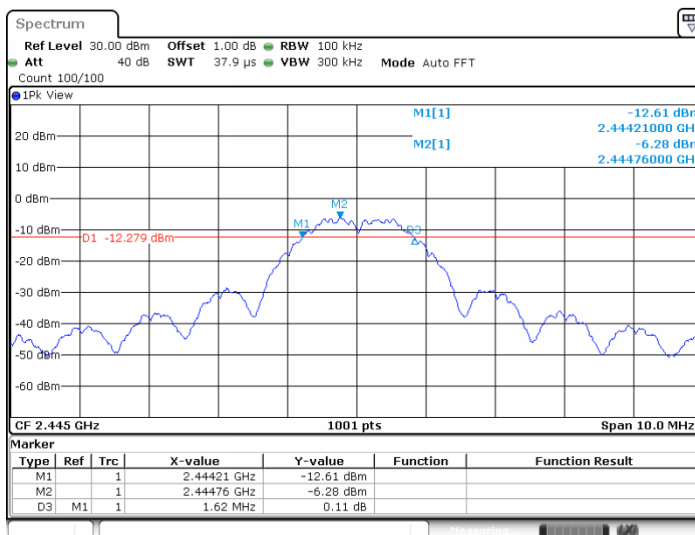

Date: 24 NOV 2020 14:52:58

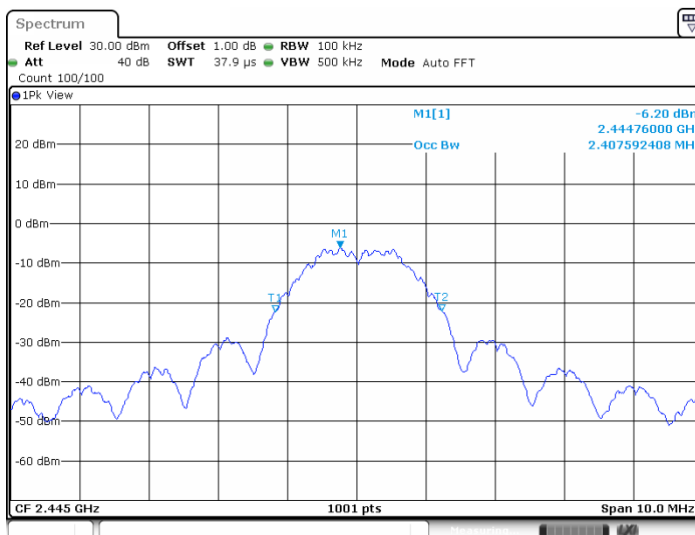

Date: 24 NOV 2020 14:53:09

Bandwidth	Measured Value	Limit
6dB bandwidth	1.620 MHz	> 0.5 MHz
99% OCB	2.408 MHz	NA

6dB & 99% Bandwidth

EUT: ROUND FREEDOM MICRO II HS
 Op Condition: Operated, TX Mode (2480MHz)
 Test Specification: FCC15.247(a)(2), 6dB Bandwidth & 99% Bandwidth
 Comment: 120V AC, 60Hz

Test Result	
<input checked="" type="checkbox"/>	Passed
<input type="checkbox"/>	Not Passed

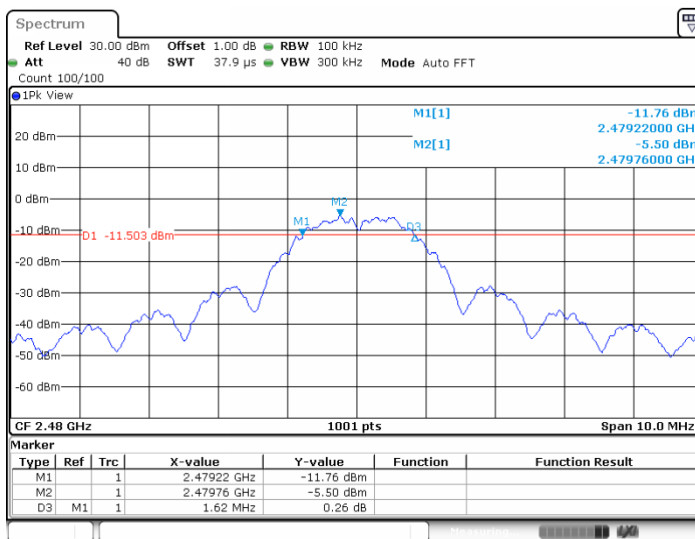

Date: 24.NOV.2020 14:54:45

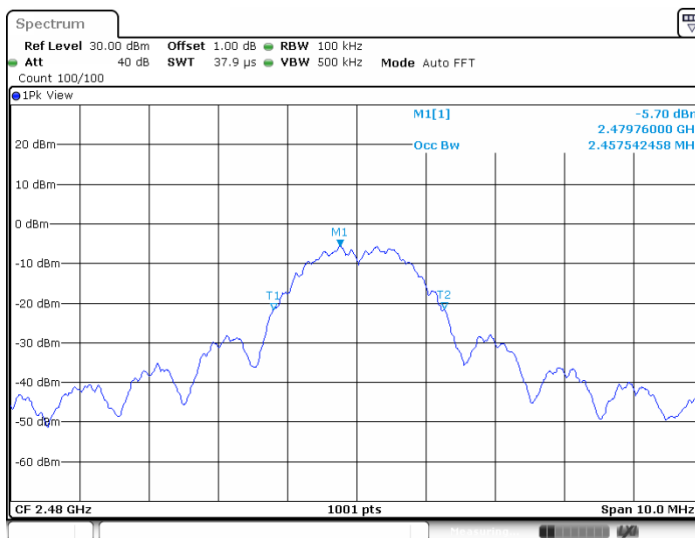

Date: 24.NOV.2020 14:54:55

Bandwidth	Measured Value	Limit
6dB bandwidth	1.620 MHz	> 0.5 MHz
99% OCB	2.458 MHz	NA

8.4 Peak Output Power

EUT: ROUND FREEDOM MICRO II HS
 Op Condition: Operated, TX Mode (2405MHz)
 Test Specification: FCC15.247(b)
 Comment: 120V AC, 60Hz

Test Result	
<input checked="" type="checkbox"/>	Passed
<input type="checkbox"/>	Not Passed

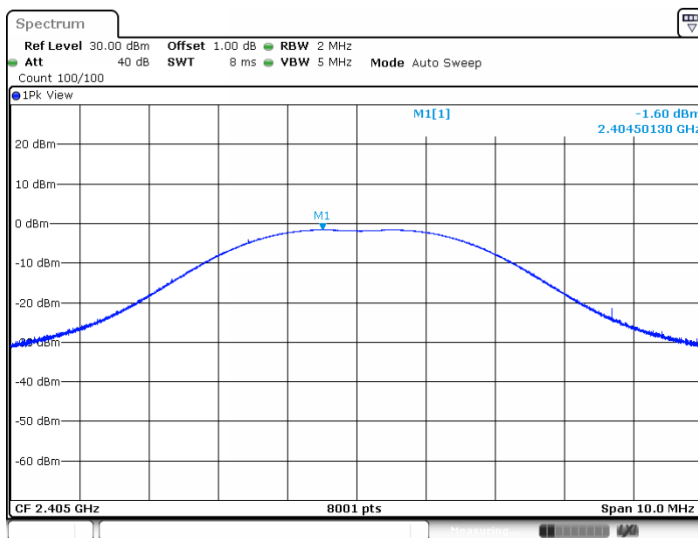

Date: 24.NOV.2020 14:52:14

Conducted Output Power	Limit
-1.60 dBm	< 30dBm

Peak Output Power

EUT: ROUND FREEDOM MICRO II HS
 Op Condition: Operated, TX Mode (2445MHz)
 Test Specification: FCC15.247(b)
 Comment: 120V AC, 60Hz

Test Result	
<input checked="" type="checkbox"/>	Passed
<input type="checkbox"/>	Not Passed

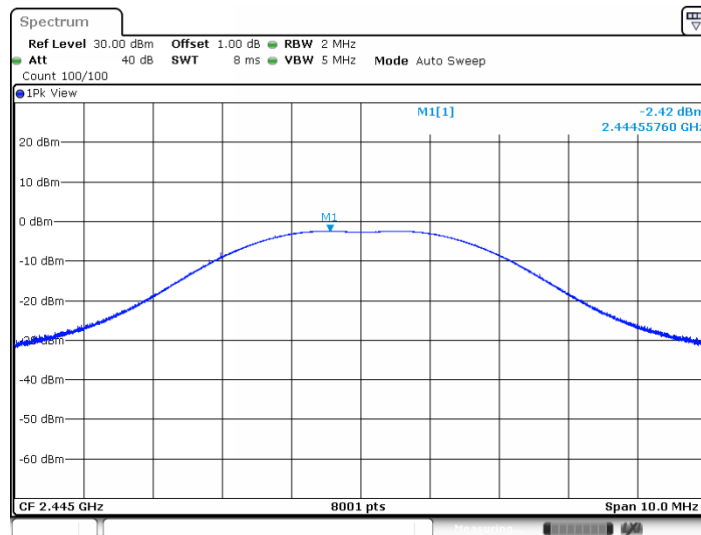

Date: 24 NOV.2020 14:53:15

Conducted Output Power	Limit
-2.42 dBm	< 30dBm

Peak Output Power

EUT: ROUND FREEDOM MICRO II HS
 Op Condition: Operated, TX Mode (2480MHz)
 Test Specification: FCC15.247(b)
 Comment: 120V AC, 60Hz

Test Result	
<input checked="" type="checkbox"/>	Passed
<input type="checkbox"/>	Not Passed

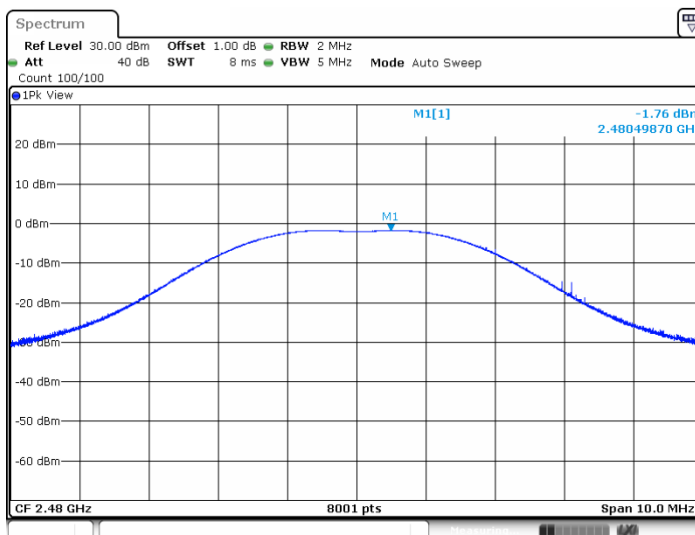

Date: 24 NOV.2020 14:55:02

Conducted Output Power	Limit
-1.76 dBm	< 30dBm

8.5 Spurious Emissions at Antenna Terminals

EUT: ROUND FREEDOM MICRO II HS
 Op Condition: Operated, TX Mode (2405MHz)
 Test Specification: FCC2.1051 & 15.247(d)
 Comment: 120V AC, 60Hz

Test Result	
<input checked="" type="checkbox"/>	Passed
<input type="checkbox"/>	Not Passed

Channel	FreqRange MHz	RefLevel dBm	Result dBm	Limit dBm	Verdict
2405	2405	-4.35	-4.35	---	PASS
2405	30~1000	-4.35	-66.39	<=-24.35	PASS
2405	1000~26500	-4.35	-45.4	<=-24.35	PASS

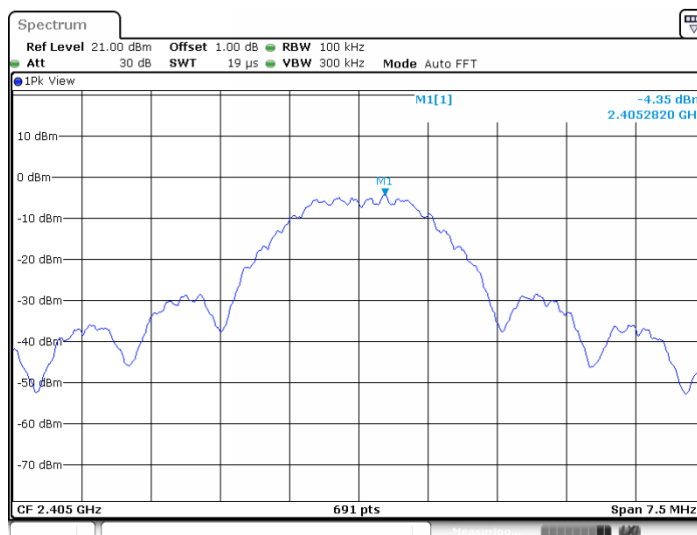

Date: 24 NOV 2020 14:49:32

Spurious Emissions at Antenna Terminals

EUT: ROUND FREEDOM MICRO II HS
 Op Condition: Operated, TX Mode (2405MHz)
 Test Specification: FCC2.1051 & 15.247(d)
 Comment: 120V AC, 60Hz

Test Result	
<input checked="" type="checkbox"/>	Passed
<input type="checkbox"/>	Not Passed

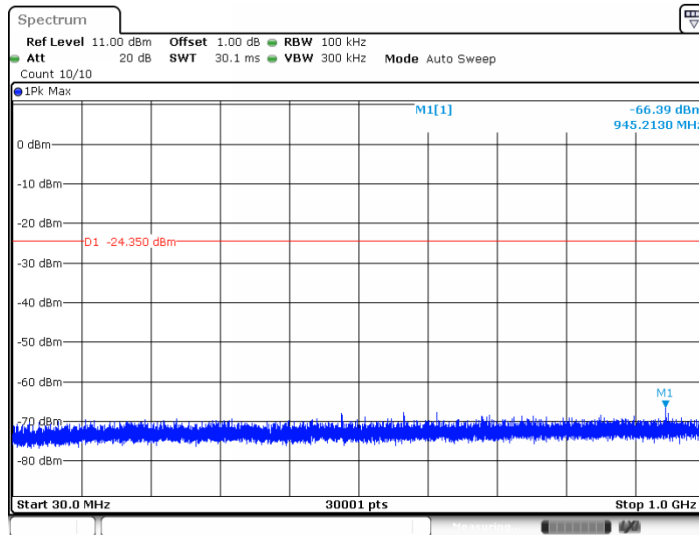

Date: 24 NOV 2020 14:49:38

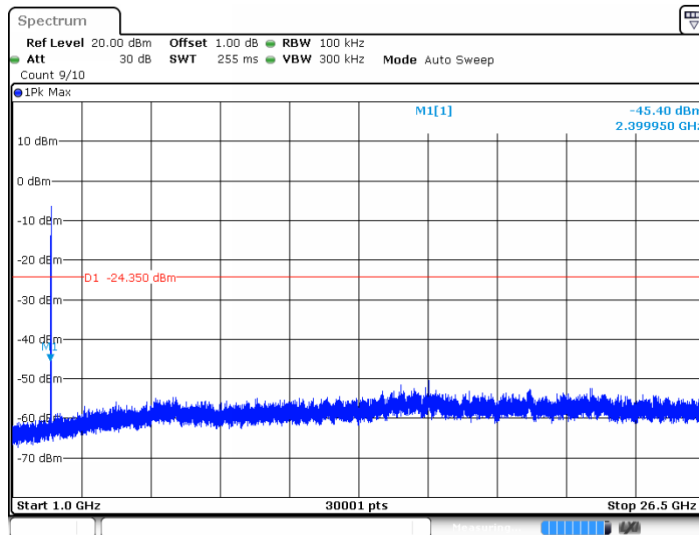

Date: 24 NOV 2020 14:49:46

Spurious Emissions at Antenna Terminals

EUT: ROUND FREEDOM MICRO II HS
 Op Condition: Operated, TX Mode (2445MHz)
 Test Specification: FCC2.1051 & 15.247(d)
 Comment: 120V AC, 60Hz

Test Result	
<input checked="" type="checkbox"/>	Passed
<input type="checkbox"/>	Not Passed

Channel	FreqRange MHz	RefLevel dBm	Result dBm	Limit dBm	Verdict
2445	2445	-6.25	-6.25	---	PASS
2445	30~1000	-6.25	-66.75	<=-26.25	PASS
2445	1000~26500	-6.25	-52.67	<=-26.25	PASS

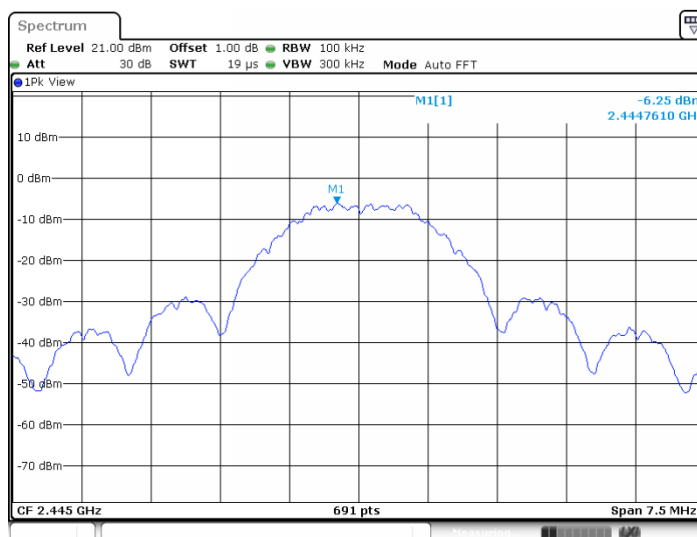

Date: 24.NOV.2020 14:53:26

Spurious Emissions at Antenna Terminals

EUT: ROUND FREEDOM MICRO II HS
 Op Condition: Operated, TX Mode (2445MHz)
 Test Specification: FCC2.1051 & 15.247(d)
 Comment: 120V AC, 60Hz

Test Result	
<input checked="" type="checkbox"/>	Passed
<input type="checkbox"/>	Not Passed

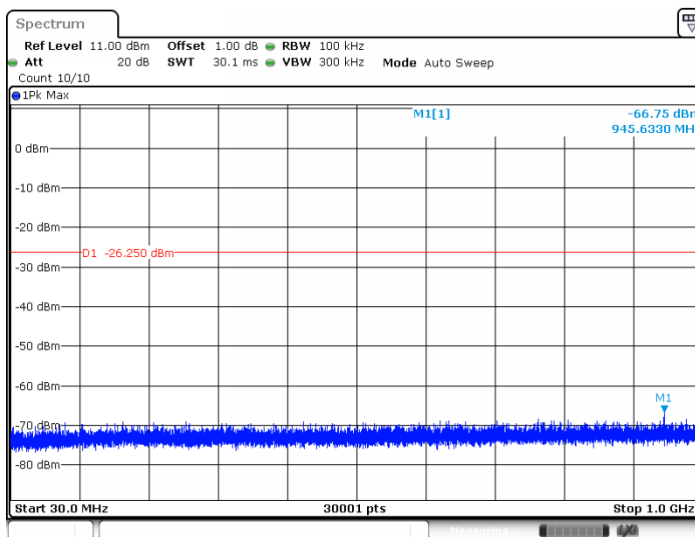

Date: 24.NOV.2020 14:53:32

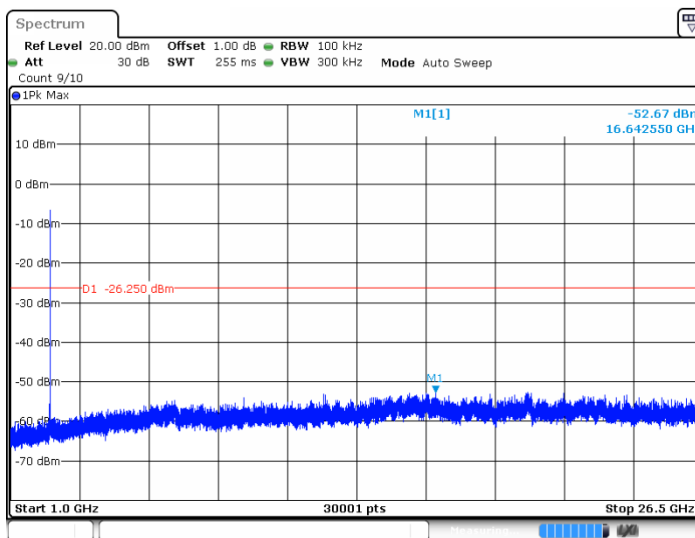

Date: 24.NOV.2020 14:53:40

Spurious Emissions at Antenna Terminals

EUT: ROUND FREEDOM MICRO II HS
 Op Condition: Operated, TX Mode (2480MHz)
 Test Specification: FCC2.1051 & 15.247(d)
 Comment: 120V AC, 60Hz

Test Result	
<input checked="" type="checkbox"/>	Passed
<input type="checkbox"/>	Not Passed

Channel	FreqRange MHz	RefLevel dBm	Result dBm	Limit dBm	Verdict
2480	2480	-5.38	-5.38	---	PASS
2480	30~1000	-5.38	-66.17	<=-25.38	PASS
2480	1000~26500	-5.38	-41.96	<=-25.38	PASS

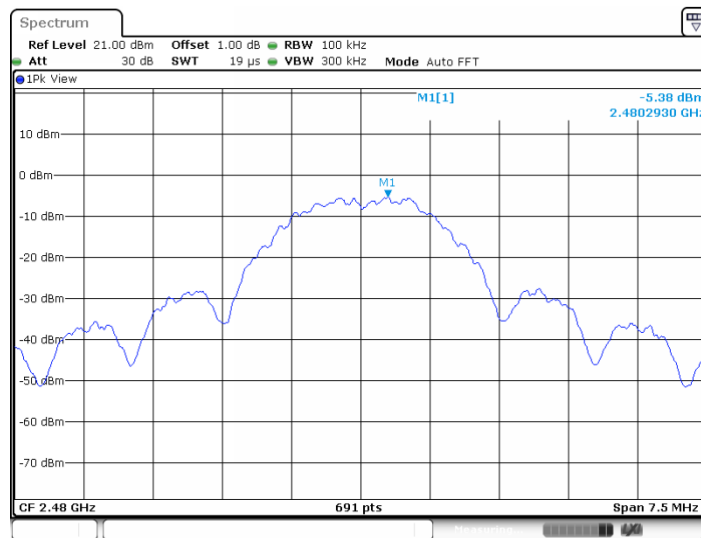

Date: 24.NOV.2020 14:55:22

Spurious Emissions at Antenna Terminals

EUT: ROUND FREEDOM MICRO II HS
 Op Condition: Operated, TX Mode (2480MHz)
 Test Specification: FCC2.1051 & 15.247(d)
 Comment: 120V AC, 60Hz

Test Result	
<input checked="" type="checkbox"/>	Passed
<input type="checkbox"/>	Not Passed

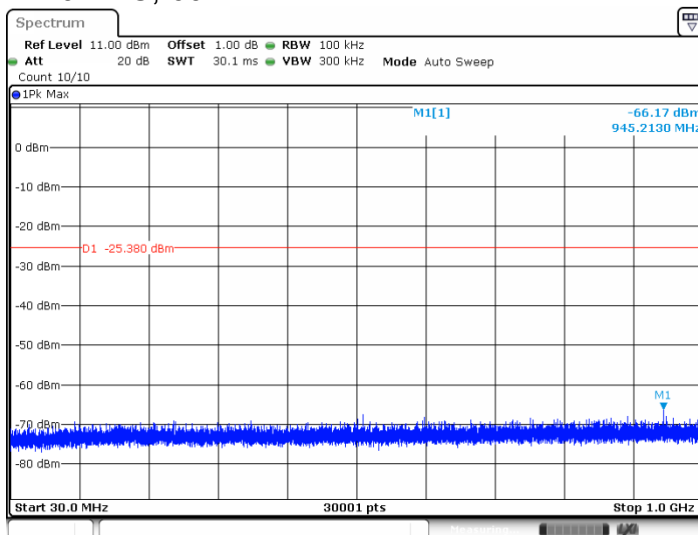

Date: 24.NOV.2020 14:55:28

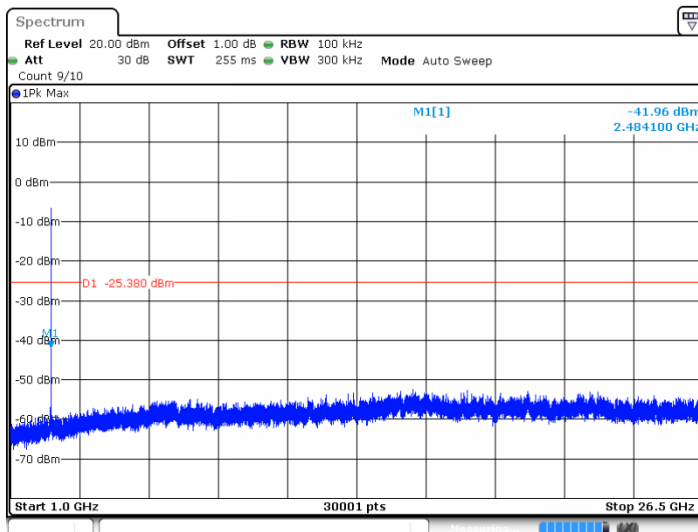

Date: 24.NOV.2020 14:55:36

8.6 100kHz Bandwidth of band edges

EUT: ROUND FREEDOM MICRO II HS
 Op Condition: Operated, TX Mode (2405MHz)
 Test Specification: FCC15.247(d), Conducted
 Comment: 120V AC, 60Hz

Test Result	
<input checked="" type="checkbox"/>	Passed
<input type="checkbox"/>	Not Passed

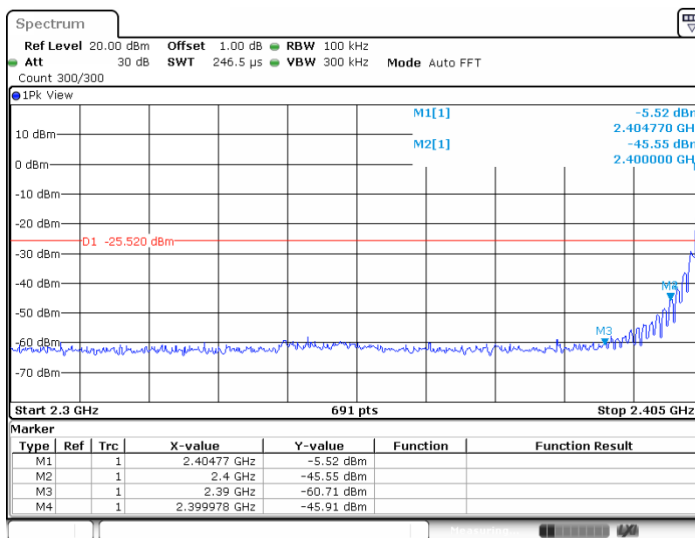

Date: 24.NOV.2020 14:49:27

Band edges	Limit
40.03 dB	> 20dB

100kHz Bandwidth of band edges

EUT: ROUND FREEDOM MICRO II HS
 Op Condition: Operated, TX Mode (2480MHz)
 Test Specification: FCC15.247(d), Conducted
 Comment: 120V AC, 60Hz

Test Result	
<input checked="" type="checkbox"/>	Passed
<input type="checkbox"/>	Not Passed

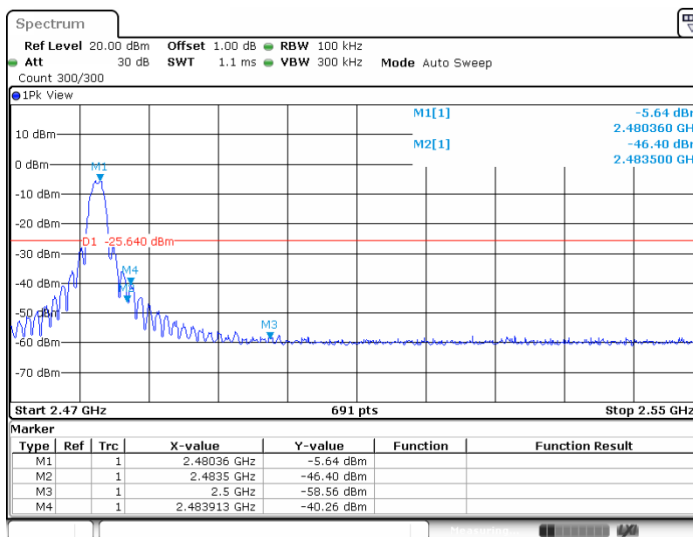

Date: 24.NOV.2020 14:55:16

Band edges	Limit
40.76 dB	> 20dB

8.7 Power Spectral Density

EUT: ROUND FREEDOM MICRO II HS
 Op Condition: Operated, TX Mode (2405MHz)
 Test Specification: FCC15.247(e)
 Comment: 120V AC, 60Hz

Test Result	
<input checked="" type="checkbox"/>	Passed
<input type="checkbox"/>	Not Passed

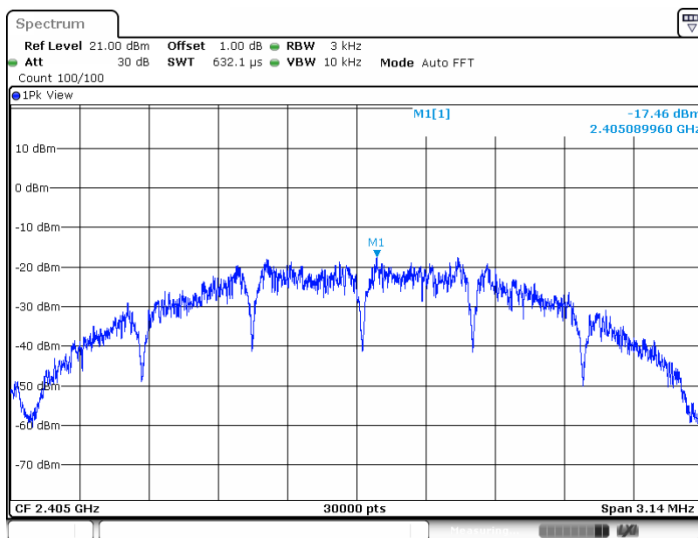

Date: 24.NOV.2020 14:57:37

PSD	Limit
-17.46 dBm/3kHz	< 8 dBm/3kHz

Power Spectral Density

EUT: ROUND FREEDOM MICRO II HS
 Op Condition: Operated, TX Mode (2445MHz)
 Test Specification: FCC15.247(e)
 Comment: 120V AC, 60Hz

Test Result	
<input checked="" type="checkbox"/>	Passed
<input type="checkbox"/>	Not Passed

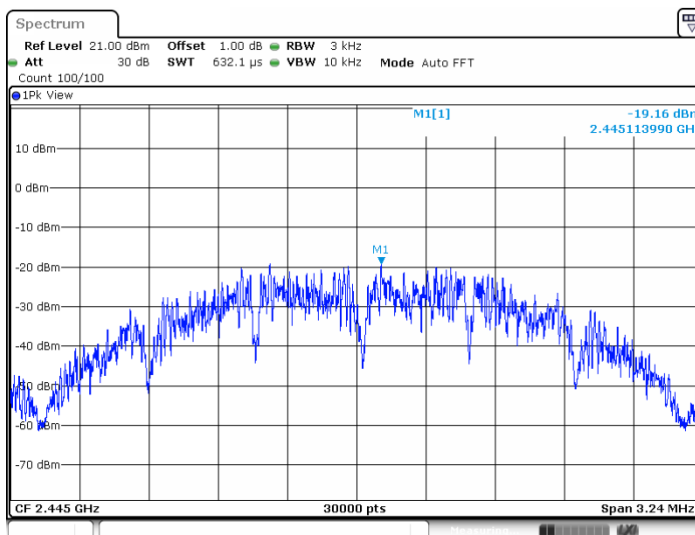

Date: 24.NOV.2020 14:59:48

PSD	Limit
-19.16 dBm/3kHz	< 8 dBm/3kHz

Power Spectral Density

EUT: ROUND FREEDOM MICRO II HS
 Op Condition: Operated, TX Mode (2480MHz)
 Test Specification: FCC15.247(e)
 Comment: 120V AC, 60Hz

Test Result	
<input checked="" type="checkbox"/>	Passed
<input type="checkbox"/>	Not Passed

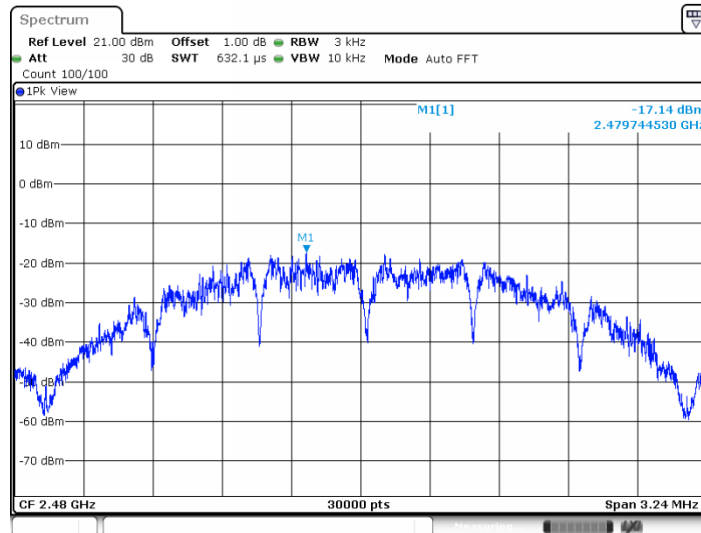

Date: 24.NOV.2020 14:56:56

PSD	Limit
-17.14 dBm/3kHz	< 8 dBm/3kHz

8.8 Antenna Requirement

EUT: ROUND FREEDOM MICRO II HS
Op Condition: Operated, TX Mode
Test Specification: FCC15.203 & 15.247(b)
Comment: 120V AC, 60Hz

Test Result	
<input checked="" type="checkbox"/>	Passed
<input type="checkbox"/>	Not Passed

Limit

For intentional device, according to FCC Title 47 Part 15.203, an intentional radiator shall be designed to ensure that no antenna other than that furnished by the responsible party shall be used with the device. And according to FCC Title 47 Part 15.247(b), if transmitting antennas of directional gain greater than 6 dBi are used, the power shall be reduced by the amount in dB that the directional gain of the antenna exceeds 6 dBi.

Antenna Connector Construction

The antenna used in this product is an internal chip antenna welded on PCB, and the maximum gain of this antenna is 0 dBi.

9 Test setup procedure

9.1 Spurious Radiated Emission

Test Method

- 1: The EUT was placed on a turn table which is 1.5m above ground plane for above 1GHz and 0.8m above ground for below 1GHz at 3 meter chamber room for test. The table was rotated 360 degrees to determine the position of the highest radiation.
- 2: The EUT was set 3 meters away from the interference – receiving antenna, which was mounted on the top of a variable – height antenna tower.
- 3: The height of antenna is varied from one meter to four meters above the ground to determine the maximum value of the field strength. Both horizontal and vertical polarizations of the antenna are set to make the measurement.
- 4: For each suspected emission, the EUT was arranged to its worst case and then the antenna was tuned to heights from 1 meter to 4 meters and the rotatable table was turned from 0 degrees to 360 degrees to find the maximum reading.
- 5: Use the following spectrum analyzer settings According to C63.10:

For Below 1GHz

Use the following spectrum analyzer settings:

Span = wide enough to capture the peak level of the in-band emission and all spurious
RBW = 100 KHz to 120KHz, VBW \geq RBW for peak measurement, Sweep = auto, Detector function = peak, Trace = max hold.

For Peak unwanted emissions Above 1GHz:

Span = wide enough to capture the peak level of the in-band emission and all spurious
RBW = 1MHz, VBW \geq RBW for peak measurement, Sweep = auto, Detector function = peak, Trace = max hold.

Procedures for average unwanted emissions measurements above 1000 MHz

a) RBW = 1MHz.

b) VBW \setminus [3 \times RBW].

c) Detector = RMS (power averaging), if [span / (# of points in sweep)] \setminus RBW / 2.

Satisfying this condition can require increasing the number of points in the sweep or reducing the span. If the condition is not satisfied, then the detector mode shall be set to peak.

d) Averaging type = power (i.e., rms) (As an alternative, the detector and averaging type may be set for linear voltage averaging. Some instruments require linear display mode to use linear voltage averaging. Log or dB averaging shall not be used.)

e) Sweep time = auto.

f) Perform a trace average of at least 100 traces if the transmission is continuous. If the transmission is not continuous, then the number of traces shall be increased by a factor of 1 / D, where D is the duty cycle. For example, with 50% duty cycle, at least 200 traces shall be averaged. (If a specific emission is demonstrated to be continuous—i.e., 100% duty cycle—then rather than turning ON and OFF with the transmit cycle, at least 100 traces shall be averaged.)

g) If tests are performed with the EUT transmitting at a duty cycle less than 98%, then a correction factor shall be added to the measurement results prior to comparing with the

emission limit, to compute the emission level that would have been measured had the test been performed at 100% duty cycle. The correction factor is computed as follows:

1) If power averaging (rms) mode was used in the preceding step e), then the correction factor is $[10 \log (1 / D)]$, where D is the duty cycle. For example, if the transmit duty cycle was 50%, then 3 dB shall be added to the measured emission levels.

2) If linear voltage averaging mode was used in the preceding step e), then the correction factor is $[20 \log (1 / D)]$, where D is the duty cycle. For example, if the transmit duty cycle was 50%, then 6 dB shall be added to the measured emission levels.

3) If a specific emission is demonstrated to be continuous (100% duty cycle) rather than turning ON and OFF with the transmit cycle, then no duty cycle correction is required for that emission.

Limit

The radio emission outside the operating frequency band shall be at least 20 dB below that in the 100 kHz bandwidth within the band that contains the highest level of the desired power. Radiated emissions which fall in the restricted bands, as defined in section RSS-GEN 8.10, must comply with the radiated emission limits specified in section 15.209.

Frequency MHz	Field Strength uV/m	Field Strength dB μ V/m	Detector
30-88	100	40	QP
88-216	150	43.5	QP
216-960	200	46	QP
960-1000	500	54	QP
Above 1000	500	54	AV
Above 1000	5000	74	PK

According to C63.10, if the peak (or quasi-peak) measured value complies with the average limit, it is unnecessary to perform an average measurement, so AV emission value did not show in below table if the peak value complies with average limit.

9.2 Conducted Emission at AC Power line

Test Method

1. The EUT was placed on a table, which is 0.8m above ground plane
2. The power line of the EUT is connected to the AC mains through a Artificial Mains Network (A.M.N.).
3. Maximum procedure was performed to ensure EUT compliance
4. A EMI test receiver is used to test the emissions from both sides of AC line

Limit

According to §15.207 & RSS-GEN 8.8, conducted emissions limit as below:

Frequency MHz	QP Limit dB μ V	AV Limit dB μ V
0.150-0.500	66-56*	56-46*
0.500-5	56	46
5-30	60	50

Remark: "*" Decreasing linearly with logarithm of the frequency

9.3 6dB & 99% Bandwidth

Test Method

1. Use the following spectrum analyzer settings:
RBW=100K, VBW \geq 3RBW, Sweep = auto, Detector function = peak, Trace = max hold
2. Use the automatic bandwidth measurement capability of an instrument, may be employed using the X dB bandwidth mode with X set to 6 dB, care shall be taken so that the bandwidth measurement is not influenced by any intermediate power nulls in the fundamental emission that might be \geq 6 dB.
3. Allow the trace to stabilize, record the X dB Bandwidth value.

Limit

Limit [kHz]

≥ 500

9.4 Peak Output Power

Test Method

1. Connect the spectrum analyzer to the EUT
 - a) The EUT is configured to transmit continuously, or to transmit with a constant duty factor.
 - b) At all times the EUT is transmitting at its maximum power control level.
 - c) The integration period of the power meter exceeds the repetition period of the transmitted signal by at least a factor of five.
2. Measure the average power of the transmitter. This measurement is an average over both the on and off periods of the transmitter.
3. Adjust the measurement in dBm by adding $10\log(1/x)$, where x is the duty cycle to the measurement result.

Limits

According to §15.247 (b) (1) & RSS-247 5.4(d), conducted peak output power limit as below:

Frequency Range MHz	Limit W	Limit dBm
2400-2483.5	≤ 1	≤ 30

For e.i r.p:

Frequency Range MHz	Limit W	Limit dBm
2400-2483.5	≤ 4	≤ 30

9.5 Spurious Emissions at Antenna Terminals

Test Method

1. Establish a reference level by using the following procedure:
 - a. Set RBW=100 kHz. VBW \geq 3RBW. Detector =peak, Sweep time = auto couple, Trace mode = max hold.
 - b. Allow trace to fully stabilize, use the peak marker function to determine the maximum PSD level.
2. Use the maximum PSD level to establish the reference level.
 - a. Set the center frequency and span to encompass frequency range to be measured.
 - b. Use the peak marker function to determine the maximum amplitude level. Ensure that the amplitude of all unwanted emissions outside of the authorized frequency band (excluding restricted frequency bands) are attenuated by at least the minimum requirements, report the three highest emissions relative to the limit.
3. Repeat above procedures until other frequencies measured were completed.

Limit

Frequency Range MHz	Limit (dBc)
30-25000	-20

9.6 100kHz Bandwidth of band edges

Test Method

- 1 Use the following spectrum analyzer settings:
Span = wide enough to capture the peak level of the in-band emission and all spurious
RBW = 100 kHz, VBW \geq RBW, Sweep = auto, Detector function = peak, Trace = max hold.
- 2 Allow the trace to stabilize, use the peak and delta measurement to record the result.
- 3 The level displayed must comply with the limit specified in this Section.

Limit

Frequency Range MHz	Limit (dBc)
30-25000	-20

9.7 Power Spectral Density

Test Method

This procedure shall be used if maximum peak conducted output power was used to demonstrate compliance:

1. Set analyzer center frequency to DTS channel center frequency. RBW=3kHz, VBW \geq 3RBW, Span=1.5 times DTS bandwidth, Detector=Peak, Sweep=auto, Trace= max hold.
2. Allow trace to fully stabilize, use the peak marker function to determine the maximum amplitude level within the RBW.
3. Repeat above procedures until other frequencies measured were completed.

Limit

Limit [dBm/3KHz]

≤ 8

10 Appendix A - General Product Information

Radiofrequency radiation exposure evaluation

This exposure evaluation is intended for **FCC ID: 2AA2X-15000282**

According to KDB 447498 D01v06 section 4.3.1, For frequencies between 100 MHz to 6GHz and test separation distances ≤ 50 mm, the Numeric threshold is determined as:

Step a)

$[(\text{max. power of channel, including tune-up tolerance, mW}) / (\text{min. test separation distance, mm})] \cdot [\sqrt{f(\text{GHz})}] \leq 3.0$ for 1-g SAR

>> The fundamental frequency of the EUT is 2405-2480MHz,
the test separation distance is ≤ 50 mm.
(Manufacturer specified the separation distance is: 20mm)

Step b)

>> Numeric threshold (2405MHz), $\text{mW} / 20\text{mm} \cdot \sqrt{2.402\text{GHz}} \leq 3.0$
Numeric threshold (2405MHz) $\leq 38.713\text{mW}$

>> Numeric threshold (2445MHz), $\text{mW} / 20\text{mm} \cdot \sqrt{2.440\text{GHz}} \leq 3.0$
Numeric threshold (2445MHz) $\leq 38.411\text{mW}$

>> Numeric threshold (2480MHz), $\text{mW} / 20\text{mm} \cdot \sqrt{2.480\text{GHz}} \leq 3.0$
Numeric threshold (2480MHz) $\leq 38.100\text{mW}$

>> The power (measured + tune up tolerance) of EUT at 2405MHz is: $-1.60\text{dBm} = 0.692\text{mW}$
The power (measured + tune up tolerance) of EUT at 2445MHz is: $-2.42\text{dBm} = 0.573\text{mW}$
The power (measured + tune up tolerance) of EUT at 2480MHz is: $-1.76\text{dBm} = 0.667\text{mW}$

Which is smaller than the Numeric threshold.

Therefore, the device is exempt from stand-alone SAR test requirements.

Reviewed by:



Eric LI
EMC Project Manager

Prepared by:

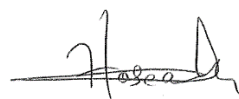
Hosea CHAN
EMC Project Engineer