



A D T

FCC TEST REPORT (15.247)

REPORT NO.: RF131111C01
MODEL NO.: DWW100
FCC ID: 2AA2U-DWW100
RECEIVED: Nov. 11, 2013
TESTED: Nov. 20, 2013
ISSUED: Nov. 29, 2013

APPLICANT: Cal-Comp Electronics & Communications
Company Limited

ADDRESS: 3th FL., No. 99, Sec. 5, Nanjing E. Rd., Taipei,
105

ISSUED BY: Bureau Veritas Consumer Products Services
(H.K.) Ltd., Taoyuan Branch

LAB ADDRESS: No. 47, 14th Ling, Chia Pau Vil., Lin Kou Dist.,
New Taipei City, Taiwan (R.O.C)

TEST LOCATION: No. 19, Hwa Ya 2nd Rd, Wen Hwa Tsuen, Kwei
Shan Hsiang, Taoyuan Hsien 333, Taiwan, R.O.C.

This report should not be used by the client to claim product certification, approval, or endorsement by TAF or any government agencies.



This report is for your exclusive use. Any copying or replication of this report to or for any other person or entity, or use of our name or trademark, is permitted only with our prior written permission. This report sets forth our findings solely with respect to the test samples identified herein. The results set forth in this report are not indicative or representative of the quality or characteristics of the lot from which a test sample was taken or any similar or identical product unless specifically and expressly noted. Our report includes all of the tests requested by you and the results thereof based upon the information that you provided to us. You have 60 days from date of issuance of this report to notify us of any material error or omission caused by our negligence, provided, however, that such notice shall be in writing and shall specifically address the issue you wish to raise. A failure to raise such issue within the prescribed time shall constitute your unqualified acceptance of the completeness of this report, the tests conducted and the correctness of the report contents. Unless specific mention, the uncertainty of measurement has been explicitly taken into account to declare the compliance or non-compliance to the specification.



TABLE OF CONTENTS

RELEASE CONTROL RECORD	4
1. CERTIFICATION.....	5
2. SUMMARY OF TEST RESULTS	6
2.1 MEASUREMENT UNCERTAINTY	6
3. GENERAL INFORMATION.....	7
3.1 GENERAL DESCRIPTION OF EUT	7
3.2 DESCRIPTION OF TEST MODES	8
3.2.1 TEST MODE APPLICABILITY AND TESTED CHANNEL DETAIL	9
3.3 DESCRIPTION OF SUPPORT UNITS	11
3.3.1 CONFIGURATION OF SYSTEM UNDER TEST	11
3.4 GENERAL DESCRIPTION OF APPLIED STANDARDS.....	12
4. TEST TYPES AND RESULTS	13
4.1 RADIATED EMISSION AND BANDEDGE MEASUREMENT	13
4.1.1 LIMITS OF RADIATED EMISSION AND BANDEDGE MEASUREMENT	13
4.1.2 TEST INSTRUMENTS	14
4.1.3 TEST PROCEDURES.....	15
4.1.4 DEVIATION FROM TEST STANDARD.....	15
4.1.5 TEST SETUP	16
4.1.6 EUT OPERATING CONDITIONS	16
4.1.7 TEST RESULTS.....	17
4.2 CONDUCTED EMISSION MEASUREMENT	30
4.2.1 LIMITS OF CONDUCTED EMISSION MEASUREMENT.....	30
4.2.2 TEST INSTRUMENTS	30
4.2.3 TEST PROCEDURES.....	31
4.2.4 DEVIATION FROM TEST STANDARD.....	31
4.2.5 TEST SETUP	32
4.2.6 EUT OPERATING CONDITIONS	32
4.2.7 TEST RESULTS.....	33
4.3 6dB BANDWIDTH MEASUREMENT.....	35
4.3.1 LIMITS OF 6dB BANDWIDTH MEASUREMENT	35
4.3.2 TEST SETUP	35
4.3.3 TEST INSTRUMENTS	35
4.3.4 TEST PROCEDURE	35
4.3.5 DEVIATION FROM TEST STANDARD.....	35
4.3.6 EUT OPERATING CONDITIONS	35
4.3.7 TEST RESULTS.....	36
4.4 CONDUCTED OUTPUT POWER	37
4.4.1 LIMITS OF CONDUCTED OUTPUT POWER MEASUREMENT	37
4.4.2 TEST SETUP	37
4.4.3 TEST INSTRUMENTS	37
4.4.4 TEST PROCEDURES.....	37
4.4.5 DEVIATION FROM TEST STANDARD.....	37
4.4.6 EUT OPERATING CONDITIONS	37
4.4.7 TEST RESULTS.....	38



4.5	POWER SPECTRAL DENSITY MEASUREMENT	40
4.5.1	LIMITS OF POWER SPECTRAL DENSITY MEASUREMENT	40
4.5.2	TEST SETUP	40
4.5.3	TEST INSTRUMENTS	40
4.5.4	TEST PROCEDURE	40
4.5.5	DEVIATION FROM TEST STANDARD.....	40
4.5.6	EUT OPERATING CONDITION.....	40
4.5.7	TEST RESULTS.....	41
4.6	CONDUCTED OUT OF BAND EMISSION MEASUREMENT	42
4.6.1	LIMITS OF CONDUCTED OUT OF BAND EMISSION MEASUREMENT	42
4.6.2	TEST SETUP	42
4.6.3	TEST INSTRUMENTS	42
4.6.4	TEST PROCEDURE	42
4.6.5	DEVIATION FROM TEST STANDARD.....	43
4.6.6	EUT OPERATING CONDITION.....	43
4.6.7	TEST RESULTS.....	43
5.	PHOTOGRAPHS OF THE TEST CONFIGURATION	48
6.	INFORMATION ON THE TESTING LABORATORIES.....	49
7.	APPENDIX A - MODIFICATIONS RECORDERS FOR ENGINEERING CHANGES TO THE EUT BY THE LAB	50



A D T

RELEASE CONTROL RECORD

ISSUE NO.	REASON FOR CHANGE	DATE ISSUED
RF131111C01	Original release	Nov. 29, 2013



A D T

1. CERTIFICATION

PRODUCT: Canvio wireless adapter
MODEL NO.: DWW100
BRAND: TOSHIBA
APPLICANT: Cal-Comp Electronics & Communications Company Limited
TESTED: Nov. 20, 2013
TEST SAMPLE: Identical Prototype
STANDARDS: **FCC Part 15, Subpart C (Section 15.247)**
ANSI C63.10-2009

The above equipment (model: DWW100) has been tested by **Bureau Veritas Consumer Products Services (H.K.) Ltd., Taoyuan Branch**, and found compliance with the requirement of the above standards. The test record, data evaluation & Equipment Under Test (EUT) configurations represented herein are true and accurate accounts of the measurements of the sample's EMC characteristics under the conditions specified in this report.

PREPARED BY : Gina Liu , **DATE** : Nov. 29, 2013
Gina Liu / Specialist

APPROVED BY : Sam chen , **DATE** : Nov. 29, 2013
Sam Chen / Assistant Manager

2. SUMMARY OF TEST RESULTS

The EUT has been tested according to the following specifications:

APPLIED STANDARD: FCC PART 15, SUBPART C			
STANDARD SECTION	TEST TYPE	RESULT	REMARK
15.207	AC Power Conducted Emission	PASS	Meet the requirement of limit. Minimum passing margin is -16.26dB at 0.52109MHz.
15.247(d) 15.209	Radiated Emissions	PASS	Meet the requirement of limit. Minimum passing margin is -1.62dB at 2390MHz.
15.247(d)	Band Edge Measurement	PASS	Meet the requirement of limit.
15.247(a)(2)	6dB bandwidth	PASS	Meet the requirement of limit.
15.247(b)	Conducted power	PASS	Meet the requirement of limit.
15.247(e)	Power Spectral Density	PASS	Meet the requirement of limit.
15.203	Antenna Requirement	PASS	No antenna connector is used.

2.1 MEASUREMENT UNCERTAINTY

Where relevant, the following measurement uncertainty levels have been estimated for tests performed on the EUT as specified in CISPR 16-4-2:

MEASUREMENT	FREQUENCY	UNCERTAINTY
Conducted emissions	9kHz~30MHz	2.44 dB
Radiated emissions	30MHz ~ 200MHz	2.93 dB
	200MHz ~1000MHz	2.95 dB
	1GHz ~ 18GHz	2.26 dB
	18GHz ~ 40GHz	1.94 dB

This uncertainty represents an expanded uncertainty expressed at approximately the 95% confidence level using a coverage factor of $k = 2$.

3. GENERAL INFORMATION

3.1 GENERAL DESCRIPTION OF EUT

EUT	Canvio wireless adapter
MODEL NO.	DWW100
POWER SUPPLY	5.0Vdc (adapter or host equipment)
MODULATION TYPE	CCK, DQPSK, DBPSK for DSSS 64QAM, 16QAM, QPSK, BPSK for OFDM
MODULATION TECHNOLOGY	DSSS, OFDM
TRANSFER RATE	802.11b:11.0/ 5.5/ 2.0/ 1.0Mbps 802.11g: 54.0/ 48.0/ 36.0/ 24.0/ 18.0/ 12.0/ 9.0/ 6.0Mbps 802.11n: up to MCS7
OPERATING FREQUENCY	2412 ~ 2462MHz
NUMBER OF CHANNEL	11 for 802.11b, 802.11g, 802.11n (20MHz) 7 for 802.11n (40MHz)
OUTPUT POWER	181.134mW for 2412 ~ 2462MHz
ANTENNA TYPE	Ceramic antenna with 1dBi gain
ANTENNA CONNECTOR	NA
DATA CABLE	Refer to Note as below
I/O PORTS	Refer to user's manual
ACCESSORY DEVICES	Refer to Note as below

NOTE:

1. The EUT contains following accessory devices.

ITEM	BRAND	MODEL	SPECIFICATION
Adapter	TOSHIBA	KSA29B0500200D5	I/P: 100-240Vac, 50/60Hz, 0.5A O/P: 5Vdc, 2A
WLAN Module 1	AzureWave	AW-NH387	For components backup purpose
WLAN Module 2	AzureWave	AW-NH387L	

✧ The Manufacturer declare that module hardware of AW-NH387L is equivalent to AW-NH387. The discrepancy between models is that one has BT function and another without it. However, the BT function will be disabled by software in this application.

2. The EUT provides one completed transmitter and one receiver.

MODULATION MODE	TX FUNCTION
802.11b	1TX
802.11g	1TX
802.11n (20MHz)	1TX
802.11n (40MHz)	1TX

3. The above EUT information is declared by the manufacturer and for more detailed features description, please refer to the manufacturer's specifications or User's Manual.

3.2 DESCRIPTION OF TEST MODES

11 channels are provided for 802.11b, 802.11g and 802.11n (20MHz):

CHANNEL	FREQUENCY	CHANNEL	FREQUENCY
1	2412MHz	7	2442MHz
2	2417MHz	8	2447MHz
3	2422MHz	9	2452MHz
4	2427MHz	10	2457MHz
5	2432MHz	11	2462MHz
6	2437MHz		

7 channels are provided for 802.11n (40MHz):

CHANNEL	FREQUENCY	CHANNEL	FREQUENCY
3	2422MHz	7	2442MHz
4	2427MHz	8	2447MHz
5	2432MHz	9	2452MHz
6	2437MHz		

3.2.1 TEST MODE APPLICABILITY AND TESTED CHANNEL DETAIL

EUT CONFIGURE MODE	APPLICABLE TO				DESCRIPTION
	RE≥1G	RE<1G	PLC	APCM	
-	√	√	√	√	-

Where **RE≥1G**: Radiated Emission above 1GHz **RE<1G**: Radiated Emission below 1GHz
PLC: Power Line Conducted Emission **APCM**: Antenna Port Conducted Measurement

RADIATED EMISSION TEST (ABOVE 1GHz):

- Pre-Scan has been conducted to determine the worst-case mode from all possible combinations between available modulations, data rates and antenna ports (if EUT with antenna diversity architecture).
- Following channel(s) was (were) selected for the final test as listed below.

MODE	AVAILABLE CHANNEL	TESTED CHANNEL	MODULATION TECHNOLOGY	MODULATION TYPE	DATA RATE (Mbps)
802.11b	1 to 11	1, 6, 11	DSSS	DBPSK	1.0
802.11g	1 to 11	1, 6, 11	OFDM	BPSK	6.0
802.11n (20MHz)	1 to 11	1, 6, 11	OFDM	BPSK	MCS0
802.11n (40MHz)	3 to 9	3, 6, 9	OFDM	BPSK	MCS0

RADIATED EMISSION TEST (BELOW 1GHz):

- Pre-Scan has been conducted to determine the worst-case mode from all possible combinations between available modulations, data rates and antenna ports (if EUT with antenna diversity architecture).
- Following channel(s) was (were) selected for the final test as listed below.

MODE	AVAILABLE CHANNEL	TESTED CHANNEL	MODULATION TECHNOLOGY	MODULATION TYPE	DATA RATE (Mbps)
802.11g	1 to 11	6	OFDM	BPSK	6.0

POWER LINE CONDUCTED EMISSION TEST:

TEST CONDITION
WLAN (2.4G) Link + USB Cable + Adapter

- Following channel(s) was (were) selected for the final test as listed below.

MODE	AVAILABLE CHANNEL	TESTED CHANNEL	MODULATION TECHNOLOGY	MODULATION TYPE	DATA RATE (Mbps)
802.11g	1 to 11	6	OFDM	BPSK	6.0



BANDEDGE MEASUREMENT:

- Pre-Scan has been conducted to determine the worst-case mode from all possible combinations between available modulations, data rates and antenna ports (if EUT with antenna diversity architecture).
- Following channel(s) was (were) selected for the final test as listed below.

MODE	AVAILABLE CHANNEL	TESTED CHANNEL	MODULATION TECHNOLOGY	MODULATION TYPE	DATA RATE (Mbps)
802.11b	1 to 11	1, 11	DSSS	DBPSK	1.0
802.11g	1 to 11	1, 11	OFDM	BPSK	6.0
802.11n (20MHz)	1 to 11	1, 11	OFDM	BPSK	MCS0
802.11n (40MHz)	3 to 9	3, 9	OFDM	BPSK	MCS0

ANTENNA PORT CONDUCTED MEASUREMENT:

- This item includes all test value of each mode, but only includes spectrum plot of worst value of each mode.
- Pre-Scan has been conducted to determine the worst-case mode from all possible combinations between available modulations, data rates and antenna ports (if EUT with antenna diversity architecture).
- Following channel(s) was (were) selected for the final test as listed below.

MODE	AVAILABLE CHANNEL	TESTED CHANNEL	MODULATION TECHNOLOGY	MODULATION TYPE	DATA RATE (Mbps)
802.11b	1 to 11	1, 6, 11	DSSS	DBPSK	1.0
802.11g	1 to 11	1, 6, 11	OFDM	BPSK	6.0
802.11n (20MHz)	1 to 11	1, 6, 11	OFDM	BPSK	MCS0
802.11n (40MHz)	3 to 9	3, 6, 9	OFDM	BPSK	MCS0

TEST CONDITION:

APPLICABLE TO	ENVIRONMENTAL CONDITIONS	INPUT POWER	TESTED BY
RE≥1G	25deg. C, 65%RH	120Vac, 60Hz	Anson Lin
RE<1G	25deg. C, 65%RH	120Vac, 60Hz	Anson Lin
PLC	25deg. C, 65%RH	120Vac, 60Hz	Johnson Liao
APCM	25deg. C, 65%RH	120Vac, 60Hz	Howard Kao

3.3 DESCRIPTION OF SUPPORT UNITS

The EUT has been tested as an independent unit together with other necessary accessories or support units. The following support units or accessories were used to form a representative test configuration during the tests.

NO.	PRODUCT	BRAND	MODEL NO.	SERIAL NO.	FCC ID
1	HDD	TOSHIBA	V63700-A 500G (500GB)	N/A	N/A

NO.	SIGNAL CABLE DESCRIPTION OF THE ABOVE SUPPORT UNITS
1	N/A

- NOTE:** 1. All power cords of the above support units are non shielded (1.8m).
 2. Item 1 was provided by client.

3.3.1 CONFIGURATION OF SYSTEM UNDER TEST

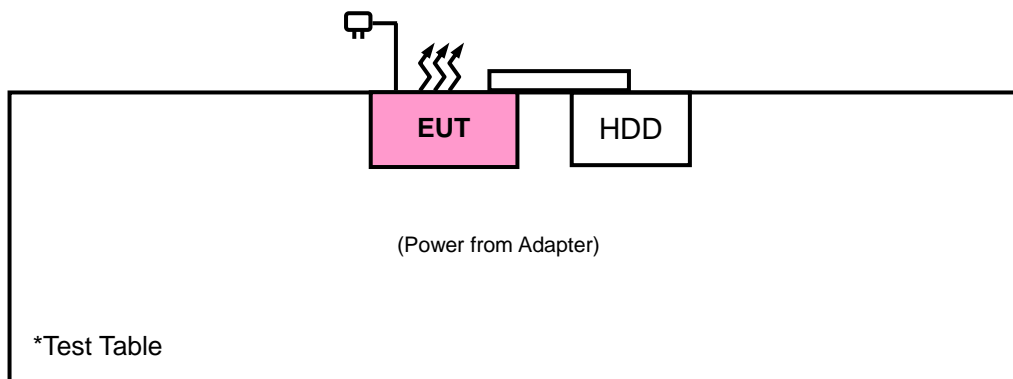



3.4 GENERAL DESCRIPTION OF APPLIED STANDARDS

The EUT is a RF Product. According to the specifications of the manufacturer, it must comply with the requirements of the following standards:

FCC Part 15, Subpart C (15.247)

ANSI C63.10-2009

KDB 558074 D01 DTS Meas Guidance v03r01

All test items have been performed and recorded as per the above standards.

NOTE: The EUT is also considered as a kind of computer peripheral, because the connection to computer is necessary for typical use. It has been verified to comply with the requirements of FCC Part 15, Subpart B, Class B (DoC). The test report has been issued separately.

4. TEST TYPES AND RESULTS

4.1 RADIATED EMISSION AND BANDEDGE MEASUREMENT

4.1.1 LIMITS OF RADIATED EMISSION AND BANDEDGE MEASUREMENT

Radiated emissions which fall in the restricted bands must comply with the radiated emission limits specified as below table. Other emissions shall be at least 20dB below the highest level of the desired power:

FREQUENCIES (MHz)	FIELD STRENGTH (microvolts/meter)	MEASUREMENT DISTANCE (meters)
0.009 ~ 0.490	2400/F(kHz)	300
0.490 ~ 1.705	24000/F(kHz)	30
1.705 ~ 30.0	30	30
30 ~ 88	100	3
88 ~ 216	150	3
216 ~ 960	200	3
Above 960	500	3

NOTE:

1. The lower limit shall apply at the transition frequencies.
2. Emission level (dBuV/m) = 20 log Emission level (uV/m).
3. For frequencies above 1000MHz, the field strength limits are based on average detector, however, the peak field strength of any emission shall not exceed the maximum permitted average limits, specified above by more than 20dB under any condition of modulation.



4.1.2 TEST INSTRUMENTS

DESCRIPTION & MANUFACTURER	MODEL NO.	SERIAL NO.	DATE OF CALIBRATION	DUE DATE OF CALIBRATION
Test Receiver ROHDE & SCHWARZ	ESCI	100744	Apr. 15, 2013	Apr. 14, 2014
Spectrum Analyzer ROHDE & SCHWARZ	FSU43	101261	Dec. 17, 2012	Dec. 16, 2013
BILOG Antenna SCHWARZBECK	VULB9168	9168-472	Mar. 25, 2013	Mar. 24, 2014
HORN Antenna SCHWARZBECK	BBHA 9120 D	9120D-969	Jan. 07, 2013	Jan. 06, 2014
HORN Antenna SCHWARZBECK	BBHA 9170	9170-480	Dec. 25, 2012	Dec. 24, 2013
Loop Antenna	HFH2-Z2	100070	Jan. 31, 2012	Jan. 30, 2014
Preamplifier EMCI	EMC 012645	980115	Dec. 28, 2012	Dec. 27, 2013
Preamplifier EMCI	EMC 184045	980116	Dec. 28, 2012	Dec. 27, 2013
Preamplifier EMCI	EMC 330H	980112	Dec. 28, 2012	Dec. 27, 2013
RF signal cable HUBER+SUHNNER	SUCOFLEX 104	222679/4	Feb. 20, 2013	Feb. 19, 2014
RF signal cable HUBER+SUHNNER	SUCOFLEX 104	274040/4	Feb. 20, 2013	Feb. 19, 2014
RF signal cable Worken	RG-213	NA	Dec. 29, 2012	Dec. 28, 2013
Software	E3 6.120103	NA	NA	NA
Antenna Tower MF	MFA-440H	NA	NA	NA
Turn Table MF	MFT-201SS	NA	NA	NA
Antenna Tower & Turn Table Controller MF	MF-7802	NA	NA	NA
Power Meter	ML2495A	1232002	Aug. 23, 2013	Aug. 22, 2014
Power Sensor	MA2411B	1207325	Aug. 23, 2013	Aug. 22, 2014

- NOTE:**
1. The calibration interval of the above test instruments is 12 months and the calibrations are traceable to NML/ROC and NIST/USA.
 2. The calibration interval of the loop antenna is 24 months and the calibrations are traceable to NML/ROC and NIST/USA.
 3. The test was performed in HwaYa Chamber 10.
 4. The horn antenna and HP preamplifier (model: 8449B) are used only for the measurement of emission frequency above 1GHz if tested.
 5. The FCC Site Registration No. is 690701.
 6. The IC Site Registration No. is IC 7450F-10.

4.1.3 TEST PROCEDURES

- a. The EUT was placed on the top of a rotating table 0.8 meters above the ground at a 3 meters semi-anechoic chamber. The table was rotated 360 degrees to determine the position of the highest radiation.
- b. The EUT was set 3 meters away from the interference-receiving antenna, which was mounted on the top of a variable-height antenna tower.
- c. Height of receiving antenna is varied from one meter to four meters above the ground to determine the maximum value of the field strength. Both horizontal and vertical polarizations of the antenna are set to make the measurement.
- d. For each suspected emission, the EUT was arranged to its worst case and then the antenna was tuned to heights from 1 meter to 4 meters and the rotatable table was turned from 0 degrees to 360 degrees to find the maximum reading.
- e. The test-receiver system was set to Peak Detect Function and Specified Bandwidth with Maximum Hold Mode.
- f. If the emission level of the EUT in peak mode was lower than the limit specified, then testing could be stopped and the peak values of the EUT would be reported. Otherwise the emissions would be re-tested one by one using peak, quasi-peak or average method as specified and then reported in a data sheet.

NOTE:

1. The resolution bandwidth and video bandwidth of test receiver/spectrum analyzer is 120kHz for Quasi-peak detection at frequency below 1GHz.
2. The resolution bandwidth of test receiver/spectrum analyzer is 1MHz and video bandwidth is 3MHz for Peak detection at frequency above 1GHz.
3. The resolution bandwidth of test receiver/spectrum analyzer is 1MHz and the video bandwidth is 10Hz for Average detection (AV) at frequency above 1GHz.
4. All modes of operation were investigated and the worst-case emissions are reported.

4.1.4 DEVIATION FROM TEST STANDARD

No deviation.

4.1.5 TEST SETUP

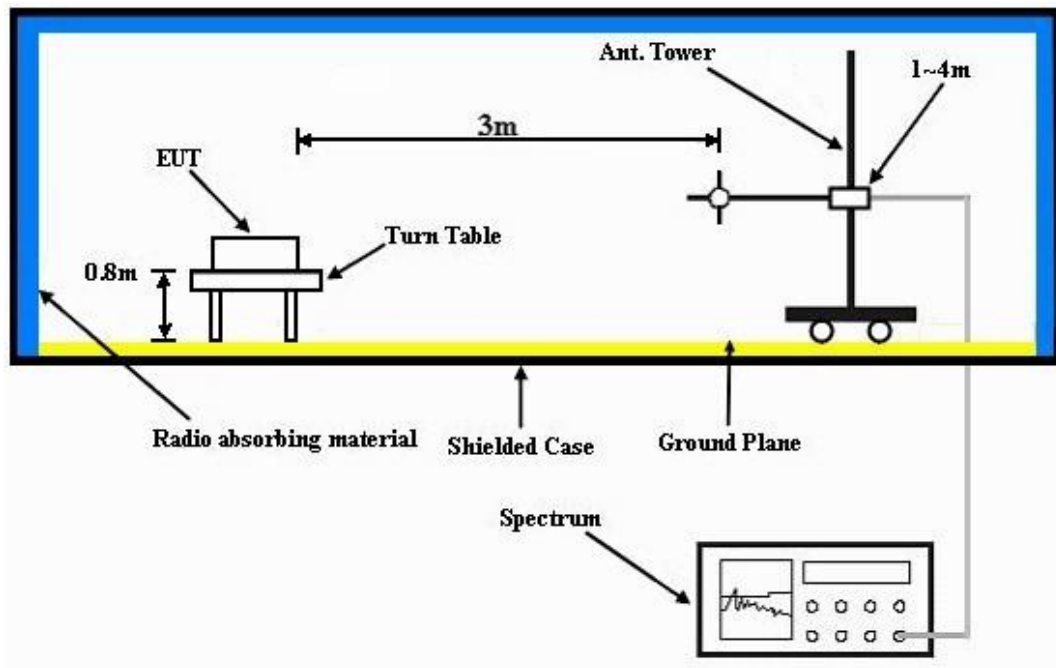

For the actual test configuration, please refer to the attached file (Test Setup Photo).

4.1.6 EUT OPERATING CONDITIONS

- a. Placed the EUT on a testing table.
- b. Use the software to control the EUT under transmission condition continuously at specific channel frequency.



4.1.7 TEST RESULTS

ABOVE 1GHz WORST-CASE DATA

802.11b

EUT TEST CONDITION		MEASUREMENT DETAIL	
CHANNEL	Channel 1	FREQUENCY RANGE	1GHz ~ 25GHz
INPUT POWER (SYSTEM)	120Vac, 60 Hz	DETECTOR FUNCTION	Peak (PK) Average (AV)
ENVIRONMENTAL CONDITIONS	25deg. C, 65%RH	TESTED BY	Anson Lin

ANTENNA POLARITY & TEST DISTANCE: HORIZONTAL AT 3 M

FREQ. (MHz)	EMISSION LEVEL (dBuV/m)	READ LEVEL (dBuV)	LIMIT (dBuV/m)	MARGIN (dB)	ANTENNA FACTOR (dB/m)	CABLE LOSS (dB)	PREAMP FACTOR (dB)	ANTENNA HEIGHT (cm)	TABLE ANGLE (Degree)	REMARK
2390	46.03	53.1	54	-7.97	26.91	3.54	37.52	102	45	Average
2390	55.5	62.57	74	-18.5	26.91	3.54	37.52	102	45	Peak
2412	103.79	110.81			26.96	3.54	37.52	102	45	Average
2412	107.9	114.92			26.96	3.54	37.52	102	45	Peak
2488	34.53	41.03	54	-19.47	27.2	3.62	37.32	102	45	Average
2488	50.51	57.01	74	-23.49	27.2	3.62	37.32	102	45	Peak

ANTENNA POLARITY & TEST DISTANCE: VERTICAL AT 3 M

FREQ. (MHz)	EMISSION LEVEL (dBuV/m)	READ LEVEL (dBuV)	LIMIT (dBuV/m)	MARGIN (dB)	ANTENNA FACTOR (dB/m)	CABLE LOSS (dB)	PREAMP FACTOR (dB)	ANTENNA HEIGHT (cm)	TABLE ANGLE (Degree)	REMARK
2390	36.46	43.53	54	-17.54	26.91	3.54	37.52	100	268	Average
2390	49.69	56.76	74	-24.31	26.91	3.54	37.52	100	268	Peak
2412	94.01	101.03			26.96	3.54	37.52	100	268	Average
2412	98.14	105.16			26.96	3.54	37.52	100	268	Peak
2490	33.04	39.54	54	-20.96	27.2	3.62	37.32	100	268	Average
2490	50.74	57.24	74	-23.26	27.2	3.62	37.32	100	268	Peak

REMARKS:

- Emission Level = Read Level + Antenna Factor + Cable Loss - Preamp Factor
Margin Value = Emission Level - Limit Value
- 2412MHz: Fundamental frequency.



A D T

EUT TEST CONDITION		MEASUREMENT DETAIL	
CHANNEL	Channel 6	FREQUENCY RANGE	1GHz ~ 25GHz
INPUT POWER (SYSTEM)	120Vac, 60 Hz	DETECTOR FUNCTION	Peak (PK) Average (AV)
ENVIRONMENTAL CONDITIONS	25deg. C, 65%RH	TESTED BY	Anson Lin

ANTENNA POLARITY & TEST DISTANCE: HORIZONTAL AT 3 M										
FREQ. (MHz)	EMISSION LEVEL (dBuV/m)	READ LEVEL (dBuV)	LIMIT (dBuV/m)	MARGIN (dB)	ANTENNA FACTOR (dB/m)	CABLE LOSS (dB)	PREAMP FACTOR (dB)	ANTENNA HEIGHT (cm)	TABLE ANGLE (Degree)	REMARK
2324	33.49	40.76	54	-20.51	26.72	3.48	37.47	102	45	Average
2324	50.16	57.43	74	-23.84	26.72	3.48	37.47	102	45	Peak
2437	104.47	111.31			27.06	3.56	37.46	102	45	Average
2437	108.26	115.1			27.06	3.56	37.46	102	45	Peak
2496	34.98	41.41	54	-19.02	27.2	3.62	37.25	102	45	Average
2496	49.99	56.42	74	-24.01	27.2	3.62	37.25	102	45	Peak
ANTENNA POLARITY & TEST DISTANCE: VERTICAL AT 3 M										
FREQ. (MHz)	EMISSION LEVEL (dBuV/m)	READ LEVEL (dBuV)	LIMIT (dBuV/m)	MARGIN (dB)	ANTENNA FACTOR (dB/m)	CABLE LOSS (dB)	PREAMP FACTOR (dB)	ANTENNA HEIGHT (cm)	TABLE ANGLE (Degree)	REMARK
2328	32.28	39.55	54	-21.72	26.72	3.48	37.47	100	268	Average
2328	50.46	57.73	74	-23.54	26.72	3.48	37.47	100	268	Peak
2437	95.36	102.2			27.06	3.56	37.46	100	268	Average
2437	99.14	105.98			27.06	3.56	37.46	100	268	Peak
2484	33.02	39.59	54	-20.98	27.15	3.6	37.32	100	268	Average
2484	50.46	57.03	74	-23.54	27.15	3.6	37.32	100	268	Peak

REMARKS:

- Emission Level = Read Level + Antenna Factor + Cable Loss - Preamp Factor
Margin Value = Emission Level - Limit Value
- 2437MHz: Fundamental frequency.



A D T

EUT TEST CONDITION		MEASUREMENT DETAIL	
CHANNEL	Channel 11	FREQUENCY RANGE	1GHz ~ 25GHz
INPUT POWER (SYSTEM)	120Vac, 60 Hz	DETECTOR FUNCTION	Peak (PK) Average (AV)
ENVIRONMENTAL CONDITIONS	25deg. C, 65%RH	TESTED BY	Anson Lin

ANTENNA POLARITY & TEST DISTANCE: HORIZONTAL AT 3 M										
FREQ. (MHz)	EMISSION LEVEL (dBuV/m)	READ LEVEL (dBuV)	LIMIT (dBuV/m)	MARGIN (dB)	ANTENNA FACTOR (dB/m)	CABLE LOSS (dB)	PREAMP FACTOR (dB)	ANTENNA HEIGHT (cm)	TABLE ANGLE (Degree)	REMARK
2352	33.54	40.72	54	-20.46	26.81	3.5	37.49	102	46	Average
2352	50.72	57.9	74	-23.28	26.81	3.5	37.49	102	46	Peak
2462	103.91	110.62			27.1	3.58	37.39	102	46	Average
2462	108.16	114.87			27.1	3.58	37.39	102	46	Peak
2484	41.8	48.37	54	-12.2	27.15	3.6	37.32	102	46	Average
2484	52.85	59.42	74	-21.15	27.15	3.6	37.32	102	46	Peak
ANTENNA POLARITY & TEST DISTANCE: VERTICAL AT 3 M										
FREQ. (MHz)	EMISSION LEVEL (dBuV/m)	READ LEVEL (dBuV)	LIMIT (dBuV/m)	MARGIN (dB)	ANTENNA FACTOR (dB/m)	CABLE LOSS (dB)	PREAMP FACTOR (dB)	ANTENNA HEIGHT (cm)	TABLE ANGLE (Degree)	REMARK
2360	32.36	39.54	54	-21.64	26.81	3.5	37.49	100	268	Average
2360	49.63	56.81	74	-24.37	26.81	3.5	37.49	100	268	Peak
2462	94.24	100.95			27.1	3.58	37.39	100	268	Average
2462	98.47	105.18			27.1	3.58	37.39	100	268	Peak
2494	34.79	41.22	54	-19.21	27.2	3.62	37.25	100	268	Average
2494	50.15	56.58	74	-23.85	27.2	3.62	37.25	100	268	Peak

REMARKS:

- Emission Level = Read Level + Antenna Factor + Cable Loss - Preamp Factor
Margin Value = Emission Level - Limit Value
- 2462MHz: Fundamental frequency.



802.11g

EUT TEST CONDITION		MEASUREMENT DETAIL	
CHANNEL	Channel 1	FREQUENCY RANGE	1GHz ~ 25GHz
INPUT POWER (SYSTEM)	120Vac, 60 Hz	DETECTOR FUNCTION	Peak (PK) Average (AV)
ENVIRONMENTAL CONDITIONS	25deg. C, 65%RH	TESTED BY	Anson Lin

ANTENNA POLARITY & TEST DISTANCE: HORIZONTAL AT 3 M										
FREQ. (MHz)	EMISSION LEVEL (dBuV/m)	READ LEVEL (dBuV)	LIMIT (dBuV/m)	MARGIN (dB)	ANTENNA FACTOR (dB/m)	CABLE LOSS (dB)	PREAMP FACTOR (dB)	ANTENNA HEIGHT (cm)	TABLE ANGLE (Degree)	REMARK
2390	52.38	59.45	54	-1.62	26.91	3.54	37.52	105	44	Average
2390	71.41	78.48	74	-2.59	26.91	3.54	37.52	105	44	Peak
2412	97.42	104.44			26.96	3.54	37.52	105	44	Average
2412	106.97	113.99			26.96	3.54	37.52	105	44	Peak
2484	37.42	43.99	54	-16.58	27.15	3.6	37.32	105	44	Average
2484	51.29	57.86	74	-22.71	27.15	3.6	37.32	105	44	Peak
ANTENNA POLARITY & TEST DISTANCE: VERTICAL AT 3 M										
FREQ. (MHz)	EMISSION LEVEL (dBuV/m)	READ LEVEL (dBuV)	LIMIT (dBuV/m)	MARGIN (dB)	ANTENNA FACTOR (dB/m)	CABLE LOSS (dB)	PREAMP FACTOR (dB)	ANTENNA HEIGHT (cm)	TABLE ANGLE (Degree)	REMARK
2390	41.75	48.82	54	-12.25	26.91	3.54	37.52	103	266	Average
2390	59.44	66.51	74	-14.56	26.91	3.54	37.52	103	266	Peak
2412	87.21	94.23			26.96	3.54	37.52	103	266	Average
2412	96.91	103.93			26.96	3.54	37.52	103	266	Peak
2494	34.05	40.48	54	-19.95	27.2	3.62	37.25	103	266	Average
2494	50.26	56.69	74	-23.74	27.2	3.62	37.25	103	266	Peak

REMARKS:

- Emission Level = Read Level + Antenna Factor + Cable Loss - Preamp Factor
Margin Value = Emission Level - Limit Value
- 2412MHz: Fundamental frequency.



A D T

EUT TEST CONDITION		MEASUREMENT DETAIL	
CHANNEL	Channel 6	FREQUENCY RANGE	1GHz ~ 25GHz
INPUT POWER (SYSTEM)	120Vac, 60 Hz	DETECTOR FUNCTION	Peak (PK) Average (AV)
ENVIRONMENTAL CONDITIONS	25deg. C, 65%RH	TESTED BY	Anson Lin

ANTENNA POLARITY & TEST DISTANCE: HORIZONTAL AT 3 M										
FREQ. (MHz)	EMISSION LEVEL (dBuV/m)	READ LEVEL (dBuV)	LIMIT (dBuV/m)	MARGIN (dB)	ANTENNA FACTOR (dB/m)	CABLE LOSS (dB)	PREAMP FACTOR (dB)	ANTENNA HEIGHT (cm)	TABLE ANGLE (Degree)	REMARK
2388	36.45	43.5	54	-17.55	26.91	3.54	37.5	103	45	Average
2388	52.55	59.6	74	-21.45	26.91	3.54	37.5	103	45	Peak
2437	97.79	104.63			27.06	3.56	37.46	103	45	Average
2437	107.35	114.19			27.06	3.56	37.46	103	45	Peak
2484	38.24	44.81	54	-15.76	27.15	3.6	37.32	103	45	Average
2484	53.49	60.06	74	-20.51	27.15	3.6	37.32	103	45	Peak

ANTENNA POLARITY & TEST DISTANCE: VERTICAL AT 3 M										
FREQ. (MHz)	EMISSION LEVEL (dBuV/m)	READ LEVEL (dBuV)	LIMIT (dBuV/m)	MARGIN (dB)	ANTENNA FACTOR (dB/m)	CABLE LOSS (dB)	PREAMP FACTOR (dB)	ANTENNA HEIGHT (cm)	TABLE ANGLE (Degree)	REMARK
2386	33.65	40.72	54	-20.35	26.91	3.52	37.5	100	267	Average
2386	50.32	57.39	74	-23.68	26.91	3.52	37.5	100	267	Peak
2437	87.98	94.82			27.06	3.56	37.46	100	267	Average
2437	97.82	104.66			27.06	3.56	37.46	100	267	Peak
2484	34.21	40.78	54	-19.79	27.15	3.6	37.32	100	267	Average
2484	50.6	57.17	74	-23.4	27.15	3.6	37.32	100	267	Peak

REMARKS:

- Emission Level = Read Level + Antenna Factor + Cable Loss - Preamp Factor
Margin Value = Emission Level - Limit Value
- 2437MHz: Fundamental frequency.



A D T

EUT TEST CONDITION		MEASUREMENT DETAIL	
CHANNEL	Channel 11	FREQUENCY RANGE	1GHz ~ 25GHz
INPUT POWER (SYSTEM)	120Vac, 60 Hz	DETECTOR FUNCTION	Peak (PK) Average (AV)
ENVIRONMENTAL CONDITIONS	25deg. C, 65%RH	TESTED BY	Anson Lin

ANTENNA POLARITY & TEST DISTANCE: HORIZONTAL AT 3 M										
FREQ. (MHz)	EMISSION LEVEL (dBuV/m)	READ LEVEL (dBuV)	LIMIT (dBuV/m)	MARGIN (dB)	ANTENNA FACTOR (dB/m)	CABLE LOSS (dB)	PREAMP FACTOR (dB)	ANTENNA HEIGHT (cm)	TABLE ANGLE (Degree)	REMARK
2338	35.66	42.86	54	-18.34	26.77	3.5	37.47	100	46	Average
2338	50	57.2	74	-24	26.77	3.5	37.47	100	46	Peak
2462	97.9	104.61			27.1	3.58	37.39	100	46	Average
2462	107.54	114.25			27.1	3.58	37.39	100	46	Peak
2484	49.21	55.78	54	-4.79	27.15	3.6	37.32	100	46	Average
2484	69.01	75.58	74	-4.99	27.15	3.6	37.32	100	46	Peak
ANTENNA POLARITY & TEST DISTANCE: VERTICAL AT 3 M										
FREQ. (MHz)	EMISSION LEVEL (dBuV/m)	READ LEVEL (dBuV)	LIMIT (dBuV/m)	MARGIN (dB)	ANTENNA FACTOR (dB/m)	CABLE LOSS (dB)	PREAMP FACTOR (dB)	ANTENNA HEIGHT (cm)	TABLE ANGLE (Degree)	REMARK
2364	33.45	40.61	54	-20.55	26.81	3.52	37.49	100	268	Average
2364	49.82	56.98	74	-24.18	26.81	3.52	37.49	100	268	Peak
2462	87.81	94.52			27.1	3.58	37.39	100	268	Average
2462	97.58	104.29			27.1	3.58	37.39	100	268	Peak
2484	40.64	47.21	54	-13.36	27.15	3.6	37.32	100	268	Average
2484	61.03	67.6	74	-12.97	27.15	3.6	37.32	100	268	Peak

REMARKS:

- Emission Level = Read Level + Antenna Factor + Cable Loss - Preamp Factor
Margin Value = Emission Level - Limit Value
- 2462MHz: Fundamental frequency.



802.11n (20MHz)

EUT TEST CONDITION		MEASUREMENT DETAIL	
CHANNEL	Channel 1	FREQUENCY RANGE	1GHz ~ 25GHz
INPUT POWER (SYSTEM)	120Vac, 60 Hz	DETECTOR FUNCTION	Peak (PK) Average (AV)
ENVIRONMENTAL CONDITIONS	25deg. C, 65%RH	TESTED BY	Anson Lin

ANTENNA POLARITY & TEST DISTANCE: HORIZONTAL AT 3 M										
FREQ. (MHz)	EMISSION LEVEL (dBuV/m)	READ LEVEL (dBuV)	LIMIT (dBuV/m)	MARGIN (dB)	ANTENNA FACTOR (dB/m)	CABLE LOSS (dB)	PREAMP FACTOR (dB)	ANTENNA HEIGHT (cm)	TABLE ANGLE (Degree)	REMARK
2390	48.18	55.25	54	-5.82	26.91	3.54	37.52	103	44	Average
2390	68.6	75.67	74	-5.4	26.91	3.54	37.52	103	44	Peak
2412	95.83	102.85			26.96	3.54	37.52	103	44	Average
2412	105.5	112.52			26.96	3.54	37.52	103	44	Peak
2496	37.76	44.19	54	-16.24	27.2	3.62	37.25	103	44	Average
2496	51.58	58.01	74	-22.42	27.2	3.62	37.25	103	44	Peak

ANTENNA POLARITY & TEST DISTANCE: VERTICAL AT 3 M										
FREQ. (MHz)	EMISSION LEVEL (dBuV/m)	READ LEVEL (dBuV)	LIMIT (dBuV/m)	MARGIN (dB)	ANTENNA FACTOR (dB/m)	CABLE LOSS (dB)	PREAMP FACTOR (dB)	ANTENNA HEIGHT (cm)	TABLE ANGLE (Degree)	REMARK
2390	39.41	46.48	54	-14.59	26.91	3.54	37.52	100	264	Average
2390	59.68	66.75	74	-14.32	26.91	3.54	37.52	100	264	Peak
2412	86.66	93.68			26.96	3.54	37.52	100	264	Average
2412	96.3	103.32			26.96	3.54	37.52	100	264	Peak
2492	34.2	40.63	54	-19.8	27.2	3.62	37.25	100	264	Average
2492	50.14	56.57	74	-23.86	27.2	3.62	37.25	100	264	Peak

REMARKS:

- Emission Level = Read Level + Antenna Factor + Cable Loss - Preamp Factor
Margin Value = Emission Level - Limit Value
- 2412MHz: Fundamental frequency.



A D T

EUT TEST CONDITION		MEASUREMENT DETAIL	
CHANNEL	Channel 6	FREQUENCY RANGE	1GHz ~ 25GHz
INPUT POWER (SYSTEM)	120Vac, 60 Hz	DETECTOR FUNCTION	Peak (PK) Average (AV)
ENVIRONMENTAL CONDITIONS	25deg. C, 65%RH	TESTED BY	Anson Lin

ANTENNA POLARITY & TEST DISTANCE: HORIZONTAL AT 3 M										
FREQ. (MHz)	EMISSION LEVEL (dBuV/m)	READ LEVEL (dBuV)	LIMIT (dBuV/m)	MARGIN (dB)	ANTENNA FACTOR (dB/m)	CABLE LOSS (dB)	PREAMP FACTOR (dB)	ANTENNA HEIGHT (cm)	TABLE ANGLE (Degree)	REMARK
2382	36.02	43.14	54	-17.98	26.86	3.52	37.5	106	46	Average
2382	50.98	58.1	74	-23.02	26.86	3.52	37.5	106	46	Peak
2437	96.09	102.93			27.06	3.56	37.46	106	46	Average
2437	106.1	112.94			27.06	3.56	37.46	106	46	Peak
2484	37.51	44.08	54	-16.49	27.15	3.6	37.32	106	46	Average
2484	54.34	60.91	74	-19.66	27.15	3.6	37.32	106	46	Peak
ANTENNA POLARITY & TEST DISTANCE: VERTICAL AT 3 M										
FREQ. (MHz)	EMISSION LEVEL (dBuV/m)	READ LEVEL (dBuV)	LIMIT (dBuV/m)	MARGIN (dB)	ANTENNA FACTOR (dB/m)	CABLE LOSS (dB)	PREAMP FACTOR (dB)	ANTENNA HEIGHT (cm)	TABLE ANGLE (Degree)	REMARK
2320	33.24	40.51	54	-20.76	26.72	3.48	37.47	100	269	Average
2320	50.12	57.39	74	-23.88	26.72	3.48	37.47	100	269	Peak
2437	86.63	93.47			27.06	3.56	37.46	100	269	Average
2437	96.73	103.57			27.06	3.56	37.46	100	269	Peak
2498	34.32	40.75	54	-19.68	27.2	3.62	37.25	100	269	Average
2498	50.17	56.6	74	-23.83	27.2	3.62	37.25	100	269	Peak

REMARKS:

- Emission Level = Read Level + Antenna Factor + Cable Loss - Preamp Factor
Margin Value = Emission Level - Limit Value
- 2437MHz: Fundamental frequency.



A D T

EUT TEST CONDITION		MEASUREMENT DETAIL	
CHANNEL	Channel 11	FREQUENCY RANGE	1GHz ~ 25GHz
INPUT POWER (SYSTEM)	120Vac, 60 Hz	DETECTOR FUNCTION	Peak (PK) Average (AV)
ENVIRONMENTAL CONDITIONS	25deg. C, 65%RH	TESTED BY	Anson Lin

ANTENNA POLARITY & TEST DISTANCE: HORIZONTAL AT 3 M										
FREQ. (MHz)	EMISSION LEVEL (dBuV/m)	READ LEVEL (dBuV)	LIMIT (dBuV/m)	MARGIN (dB)	ANTENNA FACTOR (dB/m)	CABLE LOSS (dB)	PREAMP FACTOR (dB)	ANTENNA HEIGHT (cm)	TABLE ANGLE (Degree)	REMARK
2380	35.91	43.03	54	-18.09	26.86	3.52	37.5	102	45	Average
2380	50.65	57.77	74	-23.35	26.86	3.52	37.5	102	45	Peak
2462	96.99	103.7			27.1	3.58	37.39	102	45	Average
2462	106.48	113.19			27.1	3.58	37.39	102	45	Peak
2486	46.72	53.29	54	-7.28	27.15	3.6	37.32	102	45	Average
2486	71.2	77.77	74	-2.8	27.15	3.6	37.32	102	45	Peak
ANTENNA POLARITY & TEST DISTANCE: VERTICAL AT 3 M										
FREQ. (MHz)	EMISSION LEVEL (dBuV/m)	READ LEVEL (dBuV)	LIMIT (dBuV/m)	MARGIN (dB)	ANTENNA FACTOR (dB/m)	CABLE LOSS (dB)	PREAMP FACTOR (dB)	ANTENNA HEIGHT (cm)	TABLE ANGLE (Degree)	REMARK
2352	33.25	40.43	54	-20.75	26.81	3.5	37.49	100	268	Average
2352	50.06	57.24	74	-23.94	26.81	3.5	37.49	100	268	Peak
2462	87.22	93.93			27.1	3.58	37.39	100	268	Average
2462	96.96	103.67			27.1	3.58	37.39	100	268	Peak
2486	38.19	44.76	54	-15.81	27.15	3.6	37.32	100	268	Average
2486	57.45	64.02	74	-16.55	27.15	3.6	37.32	100	268	Peak

REMARKS:

- Emission Level = Read Level + Antenna Factor + Cable Loss - Preamp Factor
Margin Value = Emission Level - Limit Value
- 2462MHz: Fundamental frequency.



802.11n (40MHz)

EUT TEST CONDITION		MEASUREMENT DETAIL	
CHANNEL	Channel 3	FREQUENCY RANGE	1GHz ~ 25GHz
INPUT POWER (SYSTEM)	120Vac, 60 Hz	DETECTOR FUNCTION	Peak (PK) Average (AV)
ENVIRONMENTAL CONDITIONS	25deg. C, 65%RH	TESTED BY	Anson Lin

ANTENNA POLARITY & TEST DISTANCE: HORIZONTAL AT 3 M

FREQ. (MHz)	EMISSION LEVEL (dBuV/m)	READ LEVEL (dBuV)	LIMIT (dBuV/m)	MARGIN (dB)	ANTENNA FACTOR (dB/m)	CABLE LOSS (dB)	PREAMP FACTOR (dB)	ANTENNA HEIGHT (cm)	TABLE ANGLE (Degree)	REMARK
2388	50.67	57.72	54	-3.33	26.91	3.54	37.5	105	45	Average
2388	63.5	70.55	74	-10.5	26.91	3.54	37.5	105	45	Peak
2422	92.62	99.51			27.01	3.56	37.46	105	45	Average
2422	101.99	108.88			27.01	3.56	37.46	105	45	Peak
2488	39.98	46.48	54	-14.02	27.2	3.62	37.32	105	45	Average
2488	55.08	61.58	74	-18.92	27.2	3.62	37.32	105	45	Peak

ANTENNA POLARITY & TEST DISTANCE: VERTICAL AT 3 M

FREQ. (MHz)	EMISSION LEVEL (dBuV/m)	READ LEVEL (dBuV)	LIMIT (dBuV/m)	MARGIN (dB)	ANTENNA FACTOR (dB/m)	CABLE LOSS (dB)	PREAMP FACTOR (dB)	ANTENNA HEIGHT (cm)	TABLE ANGLE (Degree)	REMARK
2388	40.56	47.61	54	-13.44	26.91	3.54	37.5	100	265	Average
2388	55.96	63.01	74	-18.04	26.91	3.54	37.5	100	265	Peak
2422	83.31	90.2			27.01	3.56	37.46	100	265	Average
2422	92.64	99.53			27.01	3.56	37.46	100	265	Peak
2498	35.36	41.79	54	-18.64	27.2	3.62	37.25	100	265	Average
2498	50.54	56.97	74	-23.46	27.2	3.62	37.25	100	265	Peak

REMARKS:

- Emission Level = Read Level + Antenna Factor + Cable Loss - Preamp Factor
Margin Value = Emission Level - Limit Value
- 2422MHz: Fundamental frequency.



A D T

EUT TEST CONDITION		MEASUREMENT DETAIL	
CHANNEL	Channel 6	FREQUENCY RANGE	1GHz ~ 25GHz
INPUT POWER (SYSTEM)	120Vac, 60 Hz	DETECTOR FUNCTION	Peak (PK) Average (AV)
ENVIRONMENTAL CONDITIONS	25deg. C, 65%RH	TESTED BY	Anson Lin

ANTENNA POLARITY & TEST DISTANCE: HORIZONTAL AT 3 M										
FREQ. (MHz)	EMISSION LEVEL (dBuV/m)	READ LEVEL (dBuV)	LIMIT (dBuV/m)	MARGIN (dB)	ANTENNA FACTOR (dB/m)	CABLE LOSS (dB)	PREAMP FACTOR (dB)	ANTENNA HEIGHT (cm)	TABLE ANGLE (Degree)	REMARK
2390	43.63	50.7	54	-10.37	26.91	3.54	37.52	102	44	Average
2390	61	68.07	74	-13	26.91	3.54	37.52	102	44	Peak
2437	93.72	100.56			27.06	3.56	37.46	102	44	Average
2437	103.29	110.13			27.06	3.56	37.46	102	44	Peak
2484	44.37	50.94	54	-9.63	27.15	3.6	37.32	102	44	Average
2484	66.13	72.7	74	-7.87	27.15	3.6	37.32	102	44	Peak

ANTENNA POLARITY & TEST DISTANCE: VERTICAL AT 3 M										
FREQ. (MHz)	EMISSION LEVEL (dBuV/m)	READ LEVEL (dBuV)	LIMIT (dBuV/m)	MARGIN (dB)	ANTENNA FACTOR (dB/m)	CABLE LOSS (dB)	PREAMP FACTOR (dB)	ANTENNA HEIGHT (cm)	TABLE ANGLE (Degree)	REMARK
2390	36.38	43.45	54	-17.62	26.91	3.54	37.52	100	268	Average
2390	52.32	59.39	74	-21.68	26.91	3.54	37.52	100	268	Peak
2437	84.14	90.98			27.06	3.56	37.46	100	268	Average
2437	93.65	100.49			27.06	3.56	37.46	100	268	Peak
2484	37.07	43.64	54	-16.93	27.15	3.6	37.32	100	268	Average
2484	56.13	62.7	74	-17.87	27.15	3.6	37.32	100	268	Peak

REMARKS:

- Emission Level = Read Level + Antenna Factor + Cable Loss - Preamp Factor
Margin Value = Emission Level - Limit Value
- 2437MHz: Fundamental frequency.



A D T

EUT TEST CONDITION		MEASUREMENT DETAIL	
CHANNEL	Channel 9	FREQUENCY RANGE	1GHz ~ 25GHz
INPUT POWER (SYSTEM)	120Vac, 60 Hz	DETECTOR FUNCTION	Peak (PK) Average (AV)
ENVIRONMENTAL CONDITIONS	25deg. C, 65%RH	TESTED BY	Anson Lin

ANTENNA POLARITY & TEST DISTANCE: HORIZONTAL AT 3 M										
FREQ. (MHz)	EMISSION LEVEL (dBuV/m)	READ LEVEL (dBuV)	LIMIT (dBuV/m)	MARGIN (dB)	ANTENNA FACTOR (dB/m)	CABLE LOSS (dB)	PREAMP FACTOR (dB)	ANTENNA HEIGHT (cm)	TABLE ANGLE (Degree)	REMARK
2390	35.67	42.74	54	-18.33	26.91	3.54	37.52	103	46	Average
2390	53.06	60.13	74	-20.94	26.91	3.54	37.52	103	46	Peak
2452	93.27	100.02			27.06	3.58	37.39	103	46	Average
2452	102.8	109.55			27.06	3.58	37.39	103	46	Peak
2488	44.35	50.85	54	-9.65	27.2	3.62	37.32	103	46	Average
2488	64.6	71.1	74	-9.4	27.2	3.62	37.32	103	46	Peak

ANTENNA POLARITY & TEST DISTANCE: VERTICAL AT 3 M										
FREQ. (MHz)	EMISSION LEVEL (dBuV/m)	READ LEVEL (dBuV)	LIMIT (dBuV/m)	MARGIN (dB)	ANTENNA FACTOR (dB/m)	CABLE LOSS (dB)	PREAMP FACTOR (dB)	ANTENNA HEIGHT (cm)	TABLE ANGLE (Degree)	REMARK
2386	33.58	40.65	54	-20.42	26.91	3.52	37.5	100	268	Average
2386	50.66	57.73	74	-23.34	26.91	3.52	37.5	100	268	Peak
2452	83.49	90.24			27.06	3.58	37.39	100	268	Average
2452	93.26	100.01			27.06	3.58	37.39	100	268	Peak
2484	36.77	43.34	54	-17.23	27.15	3.6	37.32	100	268	Average
2484	56.35	62.92	74	-17.65	27.15	3.6	37.32	100	268	Peak

REMARKS:

- Emission Level = Read Level + Antenna Factor + Cable Loss - Preamp Factor
Margin Value = Emission Level - Limit Value
- 2452MHz: Fundamental frequency.



BELOW 1GHz WORST-CASE DATA:

802.11g

EUT TEST CONDITION		MEASUREMENT DETAIL	
CHANNEL	Channel 6	FREQUENCY RANGE	30MHz ~ 1GHz
INPUT POWER (SYSTEM)	120Vac, 60 Hz	DETECTOR FUNCTION	Peak (PK) Quasi-peak (QP)
ENVIRONMENTAL CONDITIONS	25deg. C, 65%RH	TESTED BY	Anson Lin

ANTENNA POLARITY & TEST DISTANCE: HORIZONTAL AT 3 M										
FREQ. (MHz)	EMISSION LEVEL (dBuV/m)	READ LEVEL (dBuV)	LIMIT (dBuV/m)	MARGIN (dB)	ANTENNA FACTOR (dB/m)	CABLE LOSS (dB)	PREAMP FACTOR (dB)	ANTENNA HEIGHT (cm)	TABLE ANGLE (Degree)	REMARK
77.25	25.81	47.6	40	-14.19	8.85	0.95	31.59	102	151	Peak
133.41	36.48	55.06	43.5	-7.02	11.94	1.26	31.78	100	264	Peak
212.79	35.77	55.84	43.5	-7.73	9.89	1.65	31.61	100	189	Peak
332.9	35.53	51.44	46	-10.47	13.73	2.17	31.81	100	267	Peak
449.8	30.21	43.24	46	-15.79	16.33	2.62	31.98	100	103	Peak
650	29.56	38.13	46	-16.44	20.21	3.24	32.02	100	79	Peak
ANTENNA POLARITY & TEST DISTANCE: VERTICAL AT 3 M										
FREQ. (MHz)	EMISSION LEVEL (dBuV/m)	READ LEVEL (dBuV)	LIMIT (dBuV/m)	MARGIN (dB)	ANTENNA FACTOR (dB/m)	CABLE LOSS (dB)	PREAMP FACTOR (dB)	ANTENNA HEIGHT (cm)	TABLE ANGLE (Degree)	REMARK
76.98	33.29	54.87	40	-6.71	9.09	0.95	31.62	104	137	Peak
131.79	29.28	48.05	43.5	-14.22	11.81	1.25	31.83	102	192	Peak
206.04	30.12	50.57	43.5	-13.38	9.6	1.62	31.67	100	316	Peak
367.2	26.18	41.25	46	-19.82	14.56	2.3	31.93	100	144	Peak
449.8	24.31	37.34	46	-21.69	16.33	2.62	31.98	100	52	Peak
650	26.19	34.76	46	-19.81	20.21	3.24	32.02	100	130	Peak

REMARKS: Emission Level = Read Level + Antenna Factor + Cable Loss - Preamp Factor
 Margin Value = Emission Level - Limit Value

4.2 CONDUCTED EMISSION MEASUREMENT

4.2.1 LIMITS OF CONDUCTED EMISSION MEASUREMENT

FREQUENCY OF EMISSION (MHz)	CONDUCTED LIMIT (dB μ V)	
	Quasi-peak	Average
0.15 ~ 0.5	66 to 56	56 to 46
0.5 ~ 5	56	46
5 ~ 30	60	50

- NOTE:**
1. The lower limit shall apply at the transition frequencies.
 2. The limit decreases in line with the logarithm of the frequency in the range of 0.15 to 0.50MHz.
 3. All emanations from a class A/B digital device or system, including any network of conductors and apparatus connected thereto, shall not exceed the level of field strengths specified above.

4.2.2 TEST INSTRUMENTS

DESCRIPTION & MANUFACTURER	MODEL NO.	SERIAL NO.	DATE OF CALIBRATION	DUE DATE OF CALIBRATION
Test Receiver ROHDE & SCHWARZ	ESCS30	100291	Aug. 19, 2013	Aug. 18, 2014
RF signal cable Woken	5D-FB	Cable-HYCO2-01	Dec. 28, 2012	Dec. 27, 2013
LISN ROHDE & SCHWARZ (EUT)	ESH2-Z5	100100	Dec. 21, 2012	Dec. 20, 2013
LISN ROHDE & SCHWARZ (Peripheral)	NNBL 8226-2	8226-142	Jun. 27, 2013	Jun. 26, 2014
Software ADT	BV ADT_Cond_ V7.3.7.3	NA	NA	NA

- NOTE:**
1. The calibration interval of the above test instruments is 12 months and the calibrations are traceable to NML/ROC and NIST/USA.
 2. The test was performed in HwaYa Shielded Room 2.
 3. The VCCI Site Registration No. is C-2047.

4.2.3 TEST PROCEDURES

- a. The EUT was placed 0.4 meters from the conducting wall of the shielded room with EUT being connected to the power mains through a line impedance stabilization network (LISN). Other support units were connected to the power mains through another LISN. The two LISNs provide 50 ohm/ 50uH of coupling impedance for the measuring instrument.
- b. Both lines of the power mains connected to the EUT were checked for maximum conducted interference.
- c. The frequency range from 150kHz to 30MHz was searched. Emission levels under (Limit - 20dB) was not recorded.

NOTE: All modes of operation were investigated and the worst-case emissions are reported.

4.2.4 DEVIATION FROM TEST STANDARD

No deviation.

4.2.5 TEST SETUP

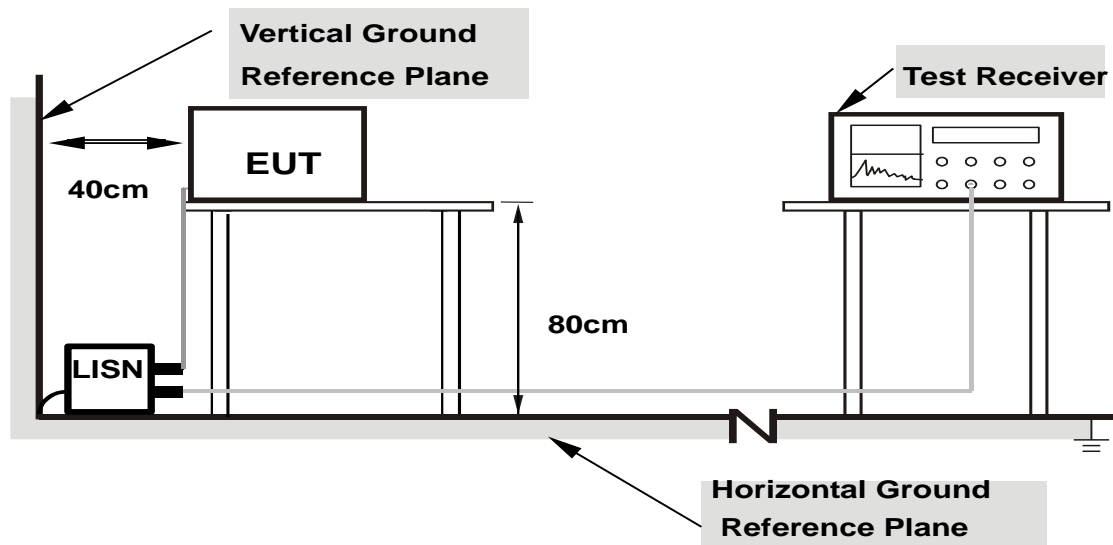

- Note:**
1. Support units were connected to second LISN.
 2. Both of LISNs (AMN) are 80 cm from EUT and at least 80 from other units and other metal planes

For the actual test configuration, please refer to the attached file (Test Setup Photo).

4.2.6 EUT OPERATING CONDITIONS

Same as 4.1.6.

4.2.7 TEST RESULTS

PHASE	Line 1	6dB BANDWIDTH	9kHz
--------------	--------	----------------------	------

No	Freq. [MHz]	Corr. Factor (dB)	Reading Value [dB (uV)]		Emission Level [dB (uV)]		Limit [dB (uV)]		Margin (dB)	
			Q.P.	AV.	Q.P.	AV.	Q.P.	AV.	Q.P.	AV.
			1	0.19687	0.17	32.67	21.39	32.84	21.56	63.74
2	0.52109	0.22	35.53	29.52	35.75	29.74	56.00	46.00	-20.25	-16.26
3	1.32031	0.27	22.36	17.13	22.63	17.40	56.00	46.00	-33.37	-28.60
4	2.53906	0.30	20.77	16.10	21.07	16.40	56.00	46.00	-34.93	-29.60
5	4.93359	0.38	15.87	11.69	16.25	12.07	56.00	46.00	-39.75	-33.93
6	16.13672	0.56	14.64	10.39	15.20	10.95	60.00	50.00	-44.80	-39.05

REMARKS:

1. Q.P. and AV. are abbreviations of quasi-peak and average individually.
2. The emission levels of other frequencies were very low against the limit.
3. Margin value = Emission level - Limit value
4. Correction factor = Insertion loss + Cable loss
5. Emission Level = Correction Factor + Reading Value

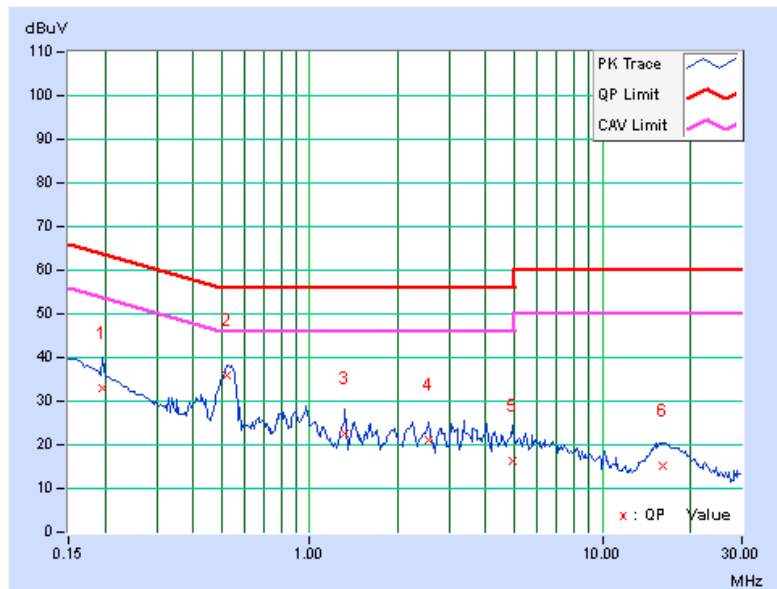

PHASE	Line 2	6dB BANDWIDTH	9kHz
-------	--------	---------------	------

No	Freq. [MHz]	Corr. Factor (dB)	Reading Value [dB (uV)]		Emission Level [dB (uV)]		Limit [dB (uV)]		Margin (dB)	
			Q.P.	AV.	Q.P.	AV.	Q.P.	AV.	Q.P.	AV.
			1	0.23984	0.19	29.22	16.26	29.41	16.45	62.10
2	0.51719	0.25	28.70	21.49	28.95	21.74	56.00	46.00	-27.05	-24.26
3	1.71094	0.27	17.68	9.89	17.95	10.16	56.00	46.00	-38.05	-35.84
4	3.50391	0.36	13.07	6.09	13.43	6.45	56.00	46.00	-42.57	-39.55
5	6.42188	0.43	12.43	4.41	12.86	4.84	60.00	50.00	-47.14	-45.16
6	17.12109	0.66	12.82	9.28	13.48	9.94	60.00	50.00	-46.52	-40.06

REMARKS:

1. Q.P. and AV. are abbreviations of quasi-peak and average individually.
2. The emission levels of other frequencies were very low against the limit.
3. Margin value = Emission level - Limit value
4. Correction factor = Insertion loss + Cable loss
5. Emission Level = Correction Factor + Reading Value

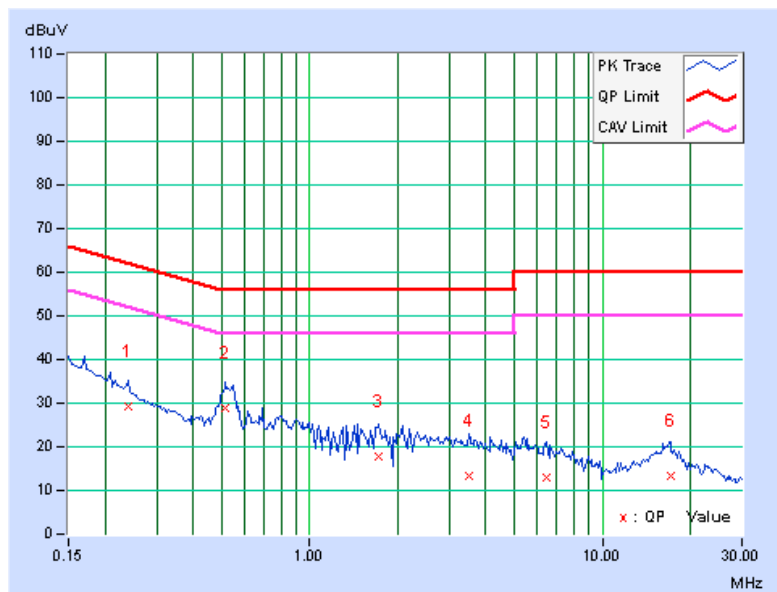

4.3 6dB BANDWIDTH MEASUREMENT

4.3.1 LIMITS OF 6dB BANDWIDTH MEASUREMENT

The minimum of 6dB Bandwidth Measurement is 0.5 MHz.

4.3.2 TEST SETUP

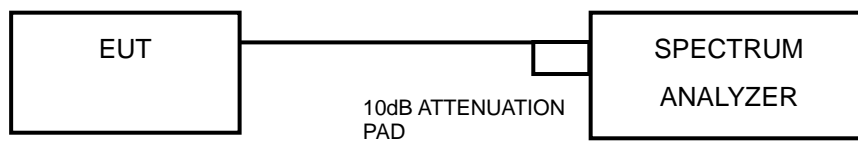

4.3.3 TEST INSTRUMENTS

Refer to section 4.1.2 to get information of above instrument.

4.3.4 TEST PROCEDURE

- Set resolution bandwidth (RBW) = 100kHz
- Set the video bandwidth (VBW) $\geq 3 \times$ RBW, Detector = Peak.
- Trace mode = max hold.
- Sweep = auto couple.
- Measure the maximum width of the emission that is constrained by the frequencies associated with the two amplitude points (upper and lower) that are attenuated by 6 dB relative to the maximum level measured in the fundamental emission

4.3.5 DEVIATION FROM TEST STANDARD

No deviation.

4.3.6 EUT OPERATING CONDITIONS

The software provided by client to enable the EUT under transmission condition continuously at lowest, middle and highest channel frequencies individually.

4.3.7 TEST RESULTS

802.11b

CHANNEL	FREQUENCY (MHz)	6dB BANDWIDTH (MHz)	MINIMUM LIMIT (MHz)	PASS / FAIL
1	2412	10.05	0.5	PASS
6	2437	10.07	0.5	PASS
11	2462	10.06	0.5	PASS

802.11g

CHANNEL	FREQUENCY (MHz)	6dB BANDWIDTH (MHz)	MINIMUM LIMIT (MHz)	PASS / FAIL
1	2412	16.62	0.5	PASS
6	2437	16.61	0.5	PASS
11	2462	16.61	0.5	PASS

802.11n (20MHz)

CHANNEL	FREQUENCY (MHz)	6dB BANDWIDTH (MHz)	MINIMUM LIMIT (MHz)	PASS / FAIL
1	2412	17.81	0.5	PASS
6	2437	17.69	0.5	PASS
11	2462	17.85	0.5	PASS

802.11n (40MHz)

CHANNEL	FREQUENCY (MHz)	6dB BANDWIDTH (MHz)	MINIMUM LIMIT (MHz)	PASS / FAIL
3	2422	36.64	0.5	PASS
6	2437	36.68	0.5	PASS
9	2452	36.66	0.5	PASS

4.4 CONDUCTED OUTPUT POWER

4.4.1 LIMITS OF CONDUCTED OUTPUT POWER MEASUREMENT

For systems using digital modulation in the 2400–2483.5 MHz bands: 1 Watt (30dBm)

4.4.2 TEST SETUP

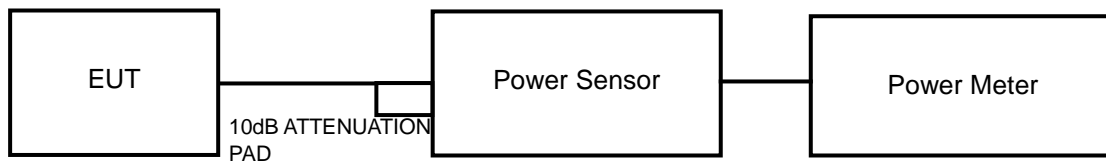

4.4.3 TEST INSTRUMENTS

Refer to section 4.1.2 to get information of above instrument.

4.4.4 TEST PROCEDURES

A peak power sensor was used on the output port of the EUT. A power meter was used to read the response of the peak power sensor. Record the peak power level.

4.4.5 DEVIATION FROM TEST STANDARD

No deviation.

4.4.6 EUT OPERATING CONDITIONS

Same as Item 4.3.6.

4.4.7 TEST RESULTS

802.11b

CHANNEL	FREQUENCY (MHz)	PEAK POWER (mW)	PEAK POWER (dBm)	LIMIT (dBm)	PASS/FAIL
1	2412	95.940	19.82	30	PASS
6	2437	100.925	20.04	30	PASS
11	2462	93.756	19.72	30	PASS

802.11g

CHANNEL	FREQUENCY (MHz)	PEAK POWER (mW)	PEAK POWER (dBm)	LIMIT (dBm)	PASS/FAIL
1	2412	172.584	22.37	30	PASS
6	2437	181.134	22.58	30	PASS
11	2462	179.887	22.55	30	PASS

802.11n (20MHz)

CHANNEL	FREQUENCY (MHz)	PEAK POWER (mW)	PEAK POWER (dBm)	LIMIT (dBm)	PASS/FAIL
1	2412	145.881	21.64	30	PASS
6	2437	152.757	21.84	30	PASS
11	2462	149.279	21.74	30	PASS

802.11n (40MHz)

CHANNEL	FREQUENCY (MHz)	PEAK POWER (mW)	PEAK POWER (dBm)	LIMIT (dBm)	PASS/FAIL
3	2422	129.122	21.11	30	PASS
6	2437	140.605	21.48	30	PASS
9	2452	142.889	21.55	30	PASS

FOR AVERAGE POWER
802.11b

CHANNEL	FREQUENCY (MHz)	AVERAGE POWER (mW)	AVERAGE POWER (dBm)
1	2412	54.450	17.36
6	2437	57.016	17.56
11	2462	51.286	17.1

802.11g

CHANNEL	FREQUENCY (MHz)	AVERAGE POWER (mW)	AVERAGE POWER (dBm)
1	2412	27.797	14.44
6	2437	28.774	14.59
11	2462	25.645	14.09

802.11n (20MHz)

CHANNEL	FREQUENCY (MHz)	AVERAGE POWER (mW)	AVERAGE POWER (dBm)
1	2412	22.131	13.45
6	2437	23.067	13.63
11	2462	20.464	13.11

802.11n (40MHz)

CHANNEL	FREQUENCY (MHz)	AVERAGE POWER (mW)	AVERAGE POWER (dBm)
3	2422	17.100	12.33
6	2437	17.378	12.4
9	2452	17.458	12.42

4.5 POWER SPECTRAL DENSITY MEASUREMENT

4.5.1 LIMITS OF POWER SPECTRAL DENSITY MEASUREMENT

The Maximum of Power Spectral Density Measurement is 8dBm.

4.5.2 TEST SETUP

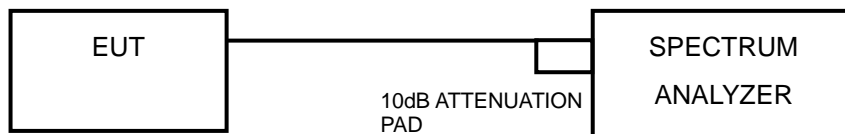

4.5.3 TEST INSTRUMENTS

Refer to section 4.1.2 to get information of above instrument.

4.5.4 TEST PROCEDURE

- a. Set the RBW = 3 kHz, VBW = 10 kHz, Detector = peak.
- b. Sweep time = auto couple, Trace mode = max hold, allow trace to fully stabilize.
- c. Use the peak marker function to determine the maximum power level in any 100 kHz band segment within the fundamental EBW.

4.5.5 DEVIATION FROM TEST STANDARD

No deviation.

4.5.6 EUT OPERATING CONDITION

Same as Item 4.3.6

4.5.7 TEST RESULTS

802.11b

Channel	FREQ. (MHz)	PSD (dBm/3kHz)	Limit (dBm/3kHz)	PASS /FAIL
1	2412	-11.55	8	PASS
6	2437	-11.33	8	PASS
11	2462	-11.80	8	PASS

802.11g

Channel	FREQ. (MHz)	PSD (dBm/3kHz)	Limit (dBm/3kHz)	PASS /FAIL
1	2412	-11.25	8	PASS
6	2437	-10.22	8	PASS
11	2462	-12.41	8	PASS

802.11n (20MHz)

Channel	FREQ. (MHz)	PSD (dBm/3kHz)	Limit (dBm/3kHz)	PASS /FAIL
1	2412	-11.30	8	PASS
6	2437	-10.54	8	PASS
11	2462	-15.31	8	PASS

802.11n (40MHz)

Channel	FREQ. (MHz)	PSD (dBm/3kHz)	Limit (dBm/3kHz)	PASS /FAIL
3	2422	-16.88	8	PASS
6	2437	-16.66	8	PASS
9	2452	-16.79	8	PASS

4.6 CONDUCTED OUT OF BAND EMISSION MEASUREMENT

4.6.1 LIMITS OF CONDUCTED OUT OF BAND EMISSION MEASUREMENT

Below -20dB of the highest emission level of operating band (in 100kHz Resolution Bandwidth).

4.6.2 TEST SETUP

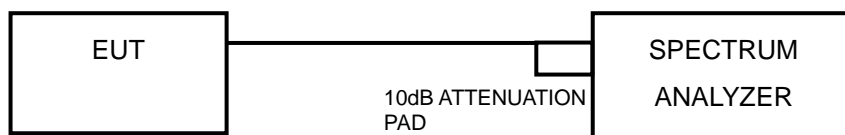

4.6.3 TEST INSTRUMENTS

Refer to section 4.1.2 to get information of above instrument.

4.6.4 TEST PROCEDURE

MEASUREMENT PROCEDURE REF

1. Set the RBW = 100 kHz .
2. Set the VBW $\geq 300\text{ kHz}$.
3. Detector = peak.
4. Sweep time = auto couple.
5. Trace mode = max hold.
6. Allow trace to fully stabilize.
7. Use the peak marker function to determine the maximum power level in any 100 kHz band segment within the fundamental EBW.

MEASUREMENT PROCEDURE OOB

1. Set RBW = 100 kHz.
2. Set VBW \geq 300 kHz.
3. Set span to encompass the spectrum to be examined.
4. Detector = peak.
5. Trace Mode = max hold.
6. Sweep = auto couple.

4.6.5 DEVIATION FROM TEST STANDARD

No deviation.

4.6.6 EUT OPERATING CONDITION

Same as Item 4.3.6

4.6.7 TEST RESULTS

The spectrum plots are attached on the following pages. D1 line indicates the highest level, and D2 line indicates the 20dB offset below D1. It shows compliance with the requirement.



A D T

802.11b

CH 1

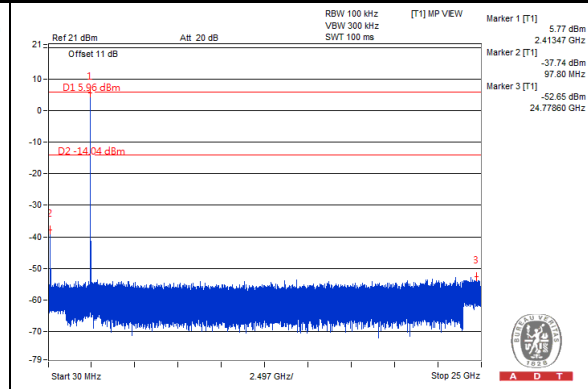
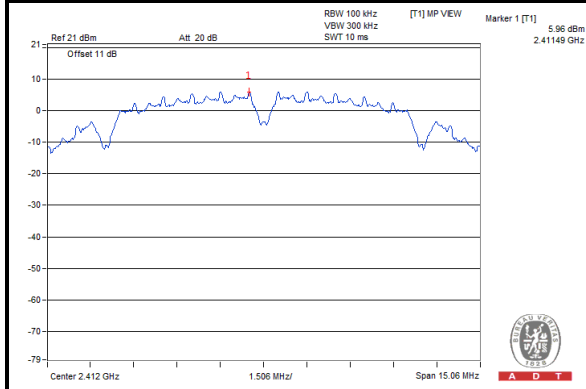

CH 6

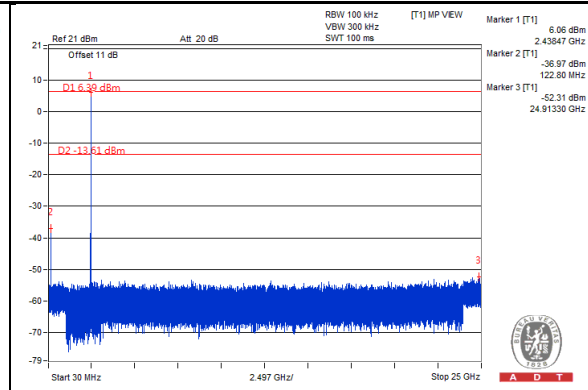
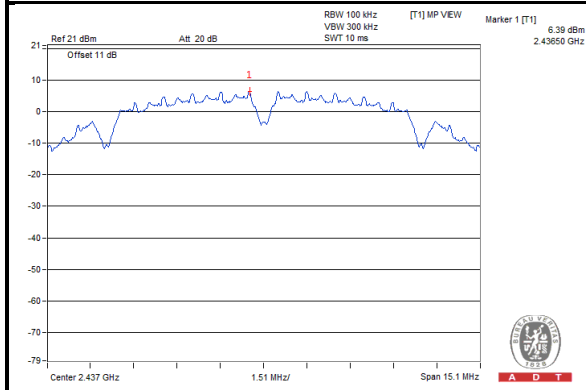

CH 11

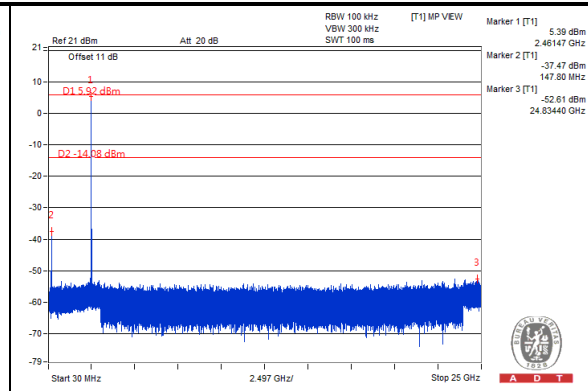
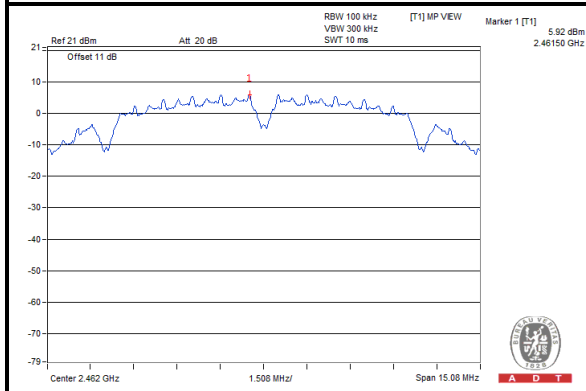



A D T

802.11g

CH 1

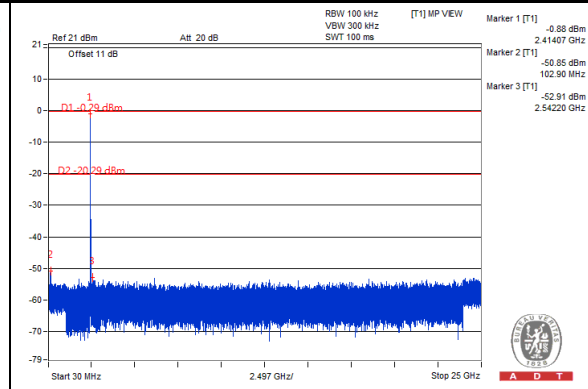
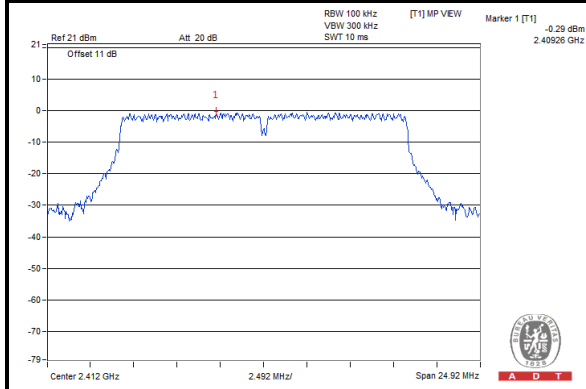

CH 6

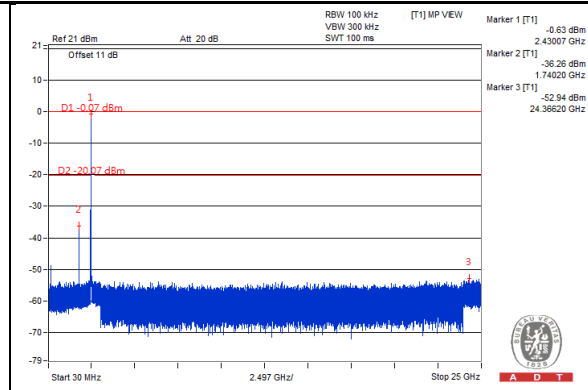
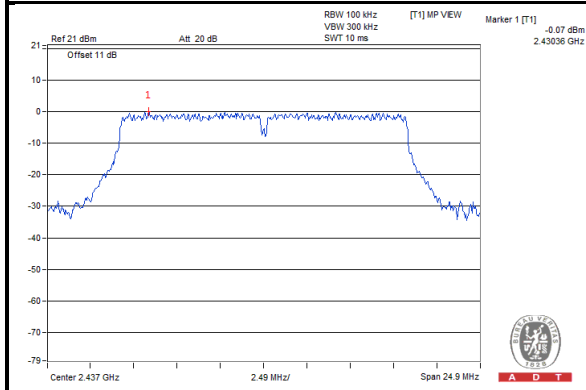

CH 11

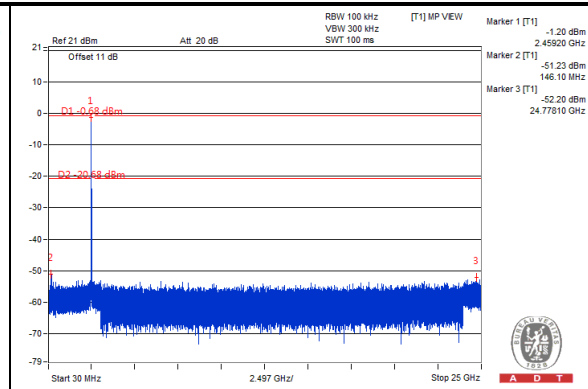
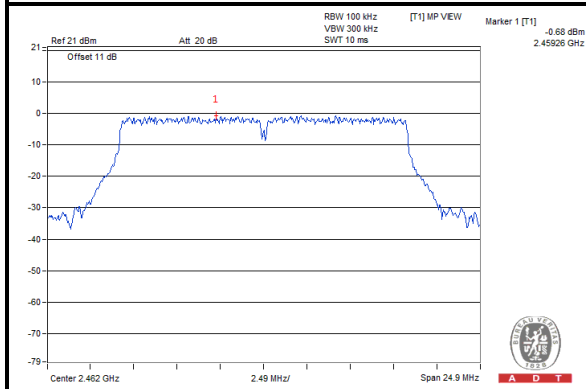



A D T

802.11n (20MHz)

CH 1

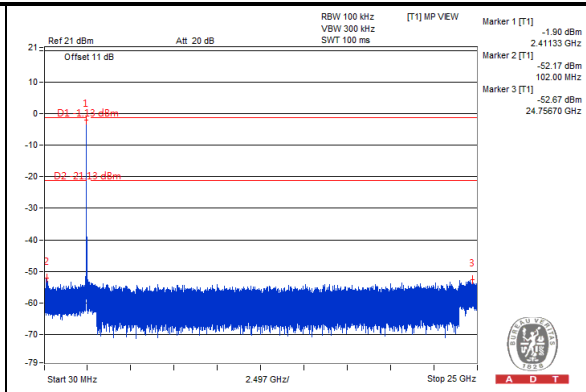
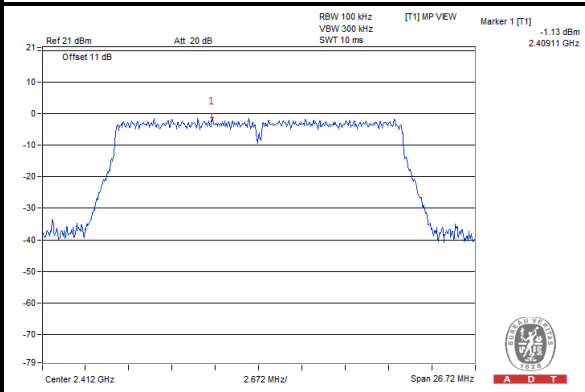

CH 6

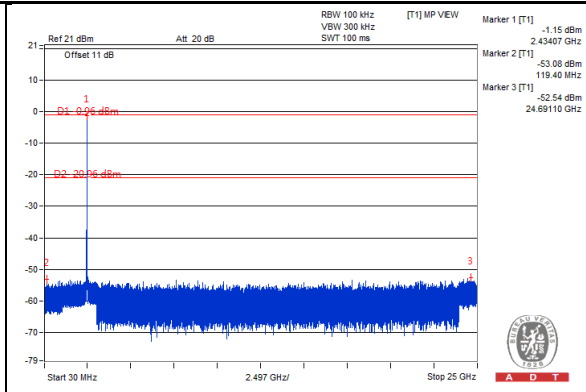
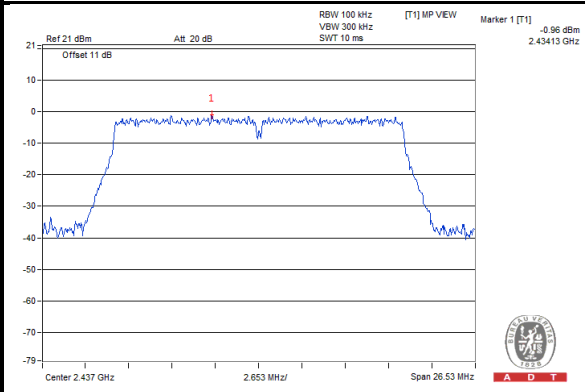

CH 11

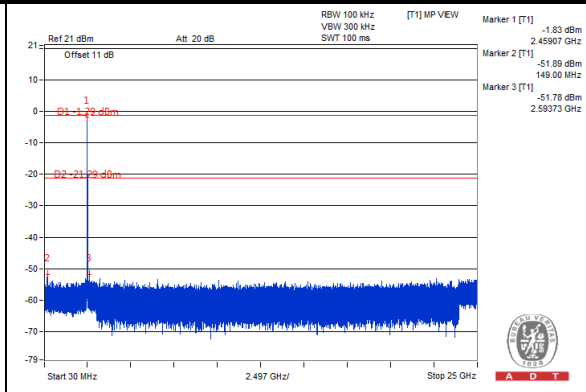
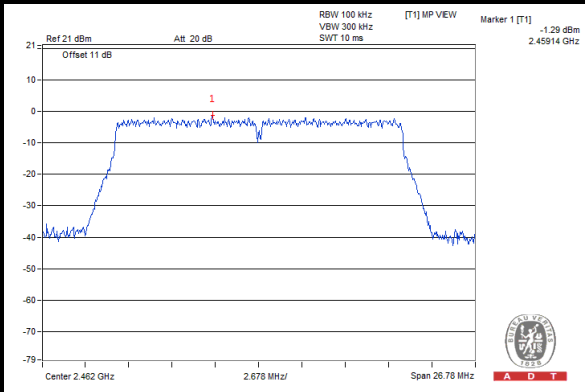



A D T

802.11n (40MHz)

CH 3

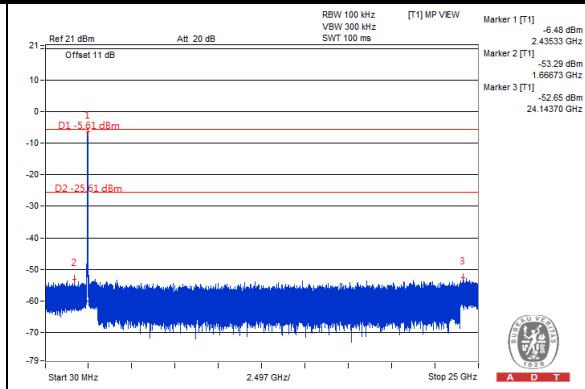
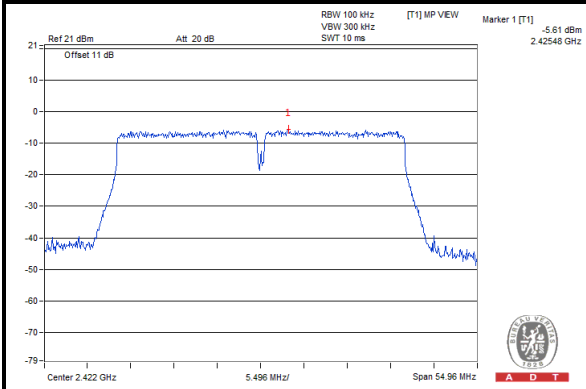

CH 6

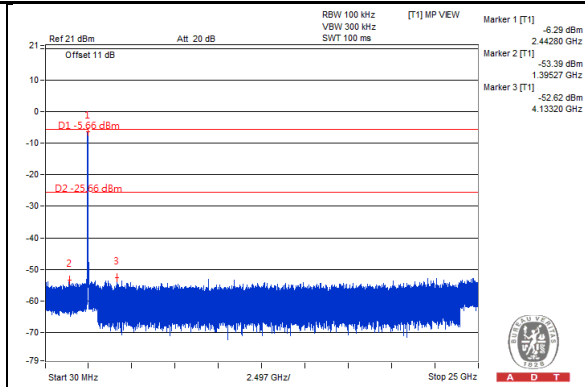
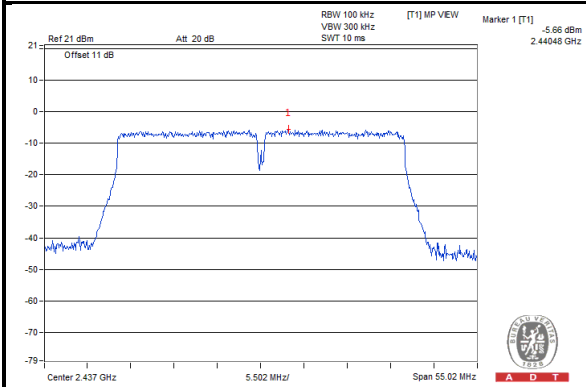

CH 9

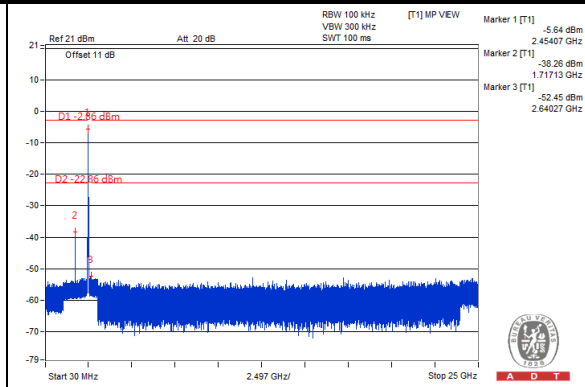
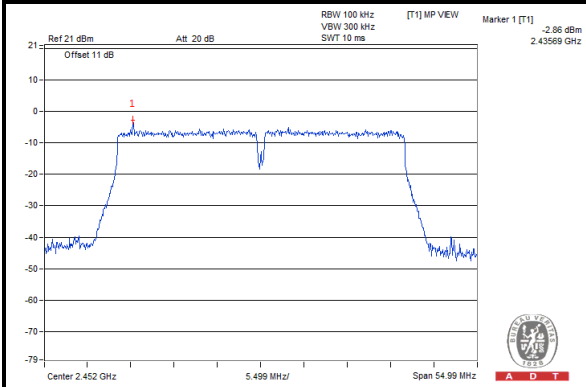



A D T

5. PHOTOGRAPHS OF THE TEST CONFIGURATION

Please refer to the attached file (Test Setup Photo).



A D T

6. INFORMATION ON THE TESTING LABORATORIES

We, Bureau Veritas Consumer Products Services (H.K.) Ltd., Taoyuan Branch, were founded in 1988 to provide our best service in EMC, Radio, Telecom and Safety consultation. Our laboratories are accredited and approved according to ISO/IEC 17025.

If you have any comments, please feel free to contact us at the following:

Linko EMC/RF Lab:

Tel: 886-2-26052180

Fax: 886-2-26051924

Hsin Chu EMC/RF Lab:

Tel: 886-3-5935343

Fax: 886-3-5935342

Hwa Ya EMC/RF/Safety Telecom Lab:

Tel: 886-3-3183232

Fax: 886-3-3270892

Email: service.adt@tw.bureauveritas.com

Web Site: www.bureauveritas-adt.com

The address and road map of all our labs can be found in our web site also.



A D T

7. APPENDIX A - MODIFICATIONS RECORDERS FOR ENGINEERING CHANGES TO THE EUT BY THE LAB

No any modifications are made to the EUT by the lab during the test.

---END---