



# FCC TEST REPORT (15.247)

**REPORT NO.:** RF140701C04  
**MODEL NO.:** DTU110; DTU1xx  
**FCC ID:** 2AA2U-DTU110  
**RECEIVED:** Jul. 01, 2014  
**TESTED:** Jul. 03, 2014 ~ Jul. 11, 2014  
**ISSUED:** Jul. 16, 2014

**APPLICANT:** Cal-Comp Electrocins and communications Co.,Ltd.

**ADDRESS:** No.147, Sec. 3, Beishen Rd., Shenkeng Dist., New Taipei City 22201, Taiwan (R.O.C.)

**ISSUED BY:** Bureau Veritas Consumer Products Services (H.K.) Ltd., Taoyuan Branch

**LAB ADDRESS:** No. 47, 14th Ling, Chia Pau Vil., Lin Kou Dist., New Taipei City, Taiwan ( R.O.C )

**TEST LOCATION:** No. 19, Hwa Ya 2nd Rd, Wen Hwa Tsuen, Kwei Shan Hsiang, Taoyuan Hsien 333, Taiwan, R.O.C.

This report should not be used by the client to claim product certification, approval, or endorsement by TAF or any government agencies.



This report is for your exclusive use. Any copying or replication of this report to or for any other person or entity, or use of our name or trademark, is permitted only with our prior written permission. This report sets forth our findings solely with respect to the test samples identified herein. The results set forth in this report are not indicative or representative of the quality or characteristics of the lot from which a test sample was taken or any similar or identical product unless specifically and expressly noted. Our report includes all of the tests requested by you and the results thereof based upon the information that you provided to us. You have 60 days from date of issuance of this report to notify us of any material error or omission caused by our negligence, provided, however, that such notice shall be in writing and shall specifically address the issue you wish to raise. A failure to raise such issue within the prescribed time shall constitute your unqualified acceptance of the completeness of this report, the tests conducted and the correctness of the report contents. Unless specific mention, the uncertainty of measurement has been explicitly taken into account to declare the compliance or non-compliance to the specification.



# TABLE OF CONTENTS

- RELEASE CONTROL RECORD ..... 4
- 1. CERTIFICATION..... 5
- 2. SUMMARY OF TEST RESULTS ..... 6
  - 2.1 MEASUREMENT UNCERTAINTY ..... 6
- 3. GENERAL INFORMATION..... 7
  - 3.1 GENERAL DESCRIPTION OF EUT..... 7
  - 3.2 DESCRIPTION OF TEST MODES..... 8
    - 3.2.1 TEST MODE APPLICABILITY AND TESTED CHANNEL DETAIL..... 9
  - 3.3 DESCRIPTION OF SUPPORT UNITS..... 11
    - 3.3.1 CONFIGURATION OF SYSTEM UNDER TEST ..... 11
  - 3.4 DUTY CYCLE TEST SIGNAL..... 12
  - 3.5 GENERAL DESCRIPTION OF APPLIED STANDARDS..... 13
- 4. TEST TYPES AND RESULTS (FOR 2.4GHz BAND)..... 14
  - 4.1 RADIATED EMISSION AND BANDEDGE MEASUREMENT ..... 14
    - 4.1.1 LIMITS OF RADIATED EMISSION AND BANDEDGE MEASUREMENT ..... 14
    - 4.1.2 TEST INSTRUMENTS..... 15
    - 4.1.3 TEST PROCEDURES ..... 16
    - 4.1.4 DEVIATION FROM TEST STANDARD ..... 16
    - 4.1.5 TEST SETUP..... 17
    - 4.1.6 EUT OPERATING CONDITIONS ..... 18
    - 4.1.7 TEST RESULTS..... 18
  - 4.2 CONDUCTED EMISSION MEASUREMENT ..... 31
    - 4.2.1 LIMITS OF CONDUCTED EMISSION MEASUREMENT ..... 31
    - 4.2.2 TEST INSTRUMENTS..... 31
    - 4.2.3 TEST PROCEDURES ..... 32
    - 4.2.4 DEVIATION FROM TEST STANDARD ..... 32
    - 4.2.5 TEST SETUP..... 33
    - 4.2.6 EUT OPERATING CONDITIONS ..... 33
    - 4.2.7 TEST RESULTS..... 34
  - 4.3 6dB BANDWIDTH MEASUREMENT ..... 36
    - 4.3.1 LIMITS OF 6dB BANDWIDTH MEASUREMENT ..... 36
    - 4.3.2 TEST SETUP..... 36
    - 4.3.3 TEST INSTRUMENTS..... 36
    - 4.3.4 TEST PROCEDURE..... 36
    - 4.3.5 DEVIATION FROM TEST STANDARD ..... 36
    - 4.3.6 EUT OPERATING CONDITIONS ..... 36
    - 4.3.7 TEST RESULTS..... 37
  - 4.4 CONDUCTED OUTPUT POWER ..... 39
    - 4.4.1 LIMITS OF CONDUCTED OUTPUT POWER MEASUREMENT..... 39
    - 4.4.2 TEST SETUP..... 39
    - 4.4.3 TEST INSTRUMENTS..... 39
    - 4.4.4 TEST PROCEDURES ..... 39
    - 4.4.5 DEVIATION FROM TEST STANDARD ..... 39
    - 4.4.6 EUT OPERATING CONDITIONS ..... 39
    - 4.4.7 TEST RESULTS..... 40
  - 4.5 POWER SPECTRAL DENSITY MEASUREMENT..... 41
    - 4.5.1 LIMITS OF POWER SPECTRAL DENSITY MEASUREMENT ..... 41
    - 4.5.2 TEST SETUP..... 41
    - 4.5.3 TEST INSTRUMENTS..... 41
    - 4.5.4 TEST PROCEDURE..... 41
    - 4.5.5 DEVIATION FROM TEST STANDARD ..... 41
    - 4.5.6 EUT OPERATING CONDITION..... 41



A D T

4.5.7	TEST RESULTS.....	42
4.6	CONDUCTED OUT OF BAND EMISSION MEASUREMENT .....	44
4.6.1	LIMITS OF CONDUCTED OUT OF BAND EMISSION MEASUREMENT.....	44
4.6.2	TEST SETUP .....	44
4.6.3	TEST INSTRUMENTS .....	44
4.6.4	TEST PROCEDURE .....	44
4.6.5	DEVIATION FROM TEST STANDARD .....	44
4.6.6	EUT OPERATING CONDITION.....	44
4.6.7	TEST RESULTS.....	45
5.	PHOTOGRAPHS OF THE TEST CONFIGURATION.....	49
6.	INFORMATION ON THE TESTING LABORATORIES .....	50
7.	APPENDIX A – MODIFICATIONS RECORDERS FOR ENGINEERING CHANGES TO THE EUT BY THE LAB .....	51



A D T

## RELEASE CONTROL RECORD

ISSUE NO.	REASON FOR CHANGE	DATE ISSUED
RF140701C04	Original release	Jul. 16, 2014



## 2. SUMMARY OF TEST RESULTS

The EUT has been tested according to the following specifications:

APPLIED STANDARD: FCC PART 15, SUBPART C (SECTION 15.247)			
STANDARD SECTION	TEST TYPE	RESULT	REMARK
15.207	AC Power Conducted Emission	PASS	Meet the requirement of limit. Minimum passing margin is -14.05dB at 0.52500MHz.
15.205 & 15.209	Radiated Emissions	PASS	Meet the requirement of limit. Minimum passing margin is -2.75dB at 7311MHz.
15.247(d)	Band Edge Measurement	PASS	Meet the requirement of limit.
15.247(d)	Antenna Port Emission	PASS	Meet the requirement of limit.
15.247(a)(2)	6dB bandwidth	PASS	Meet the requirement of limit.
15.247(b)	Conducted power	PASS	Meet the requirement of limit.
15.247(e)	Power Spectral Density	PASS	Meet the requirement of limit.
15.203	Antenna Requirement	PASS	No antenna connector is used.

### 2.1 MEASUREMENT UNCERTAINTY

Where relevant, the following measurement uncertainty levels have been estimated for tests performed on the EUT as specified in CISPR 16-4-2:

MEASUREMENT	FREQUENCY	UNCERTAINTY
Conducted emissions	9kHz~30MHz	2.44 dB
Radiated emissions	30MHz ~ 200MHz	2.93 dB
	200MHz ~1000MHz	2.95 dB
	1GHz ~ 18GHz	2.26 dB
	18GHz ~ 40GHz	1.94 dB

This uncertainty represents an expanded uncertainty expressed at approximately the 95% confidence level using a coverage factor of  $k = 2$ .



### 3. GENERAL INFORMATION

#### 3.1 GENERAL DESCRIPTION OF EUT

<b>EUT</b>	Wireless Portable Hard Drive
<b>MODEL NO.</b>	DTU110; DTU1xx
<b>MODEL DIFFERENCE</b>	DTU110 stands for 1TB capacity and DTU1xx can be any capacity
<b>POWER SUPPLY</b>	5.0Vdc (adapter)
<b>MODULATION TYPE</b>	CCK, DQPSK, DBPSK for DSSS 64QAM, 16QAM, QPSK, BPSK for OFDM
<b>MODULATION TECHNOLOGY</b>	DSSS, OFDM
<b>TRANSFER RATE</b>	802.11b: 11.0 / 5.5 / 2.0 / 1.0 Mbps 802.11g: 54.0 / 48.0 / 36.0 / 24.0 / 18.0 / 12.0 / 9.0 / 6.0 Mbps 802.11n: up to MCS7
<b>OPERATING FREQUENCY</b>	2412 ~ 2462MHz
<b>NUMBER OF CHANNEL</b>	11 for 802.11b, 802.11g, 802.11n (20MHz) 7 for 802.11n (40MHz)
<b>OUTPUT POWER</b>	160.69mW for 2412 ~ 2462MHz
<b>ANTENNA TYPE</b>	PIFA antenna with 1dBi gain
<b>ANTENNA CONNECTOR</b>	NA
<b>DATA CABLE</b>	Refer to Note as below
<b>I/O PORTS</b>	Refer to user's manual
<b>ACCESSORY DEVICES</b>	Refer to Note as below

**NOTE:**

1. The detail information of model names is as below.

MODEL	DESCRIPTION
DTU110	1TB capacity
DTU1xx	"xx" can be any digital for HDD storage sizes

\*The model of 'DTU110' was chosen for final test.

2. The EUT contains following accessory devices.

ITEM	BRAND	MODEL	SPECIFICATION
Adapter	Ktec	KSA29B0500200D5	I/P: 100-240Vac, 50/60Hz, 500mA O/P: 5Vdc, 2A

3. The above EUT information is declared by the manufacturer and for more detailed features description, please refer to the manufacturer's specifications or User's Manual.



A D T

### 3.2 DESCRIPTION OF TEST MODES

#### FOR 2.4GHz:

11 channels are provided for 802.11b, 802.11g and 802.11n (20MHz):

CHANNEL	FREQUENCY	CHANNEL	FREQUENCY
1	2412MHz	7	2442MHz
2	2417MHz	8	2447MHz
3	2422MHz	9	2452MHz
4	2427MHz	10	2457MHz
5	2432MHz	11	2462MHz
6	2437MHz		

7 channels are provided for 802.11n (40MHz):

CHANNEL	FREQUENCY	CHANNEL	FREQUENCY
3	2422MHz	7	2442MHz
4	2427MHz	8	2447MHz
5	2432MHz	9	2452MHz
6	2437MHz		





### 3.2.1 TEST MODE APPLICABILITY AND TESTED CHANNEL DETAIL

#### WLAN 2.4GHz:

EUT CONFIGURE MODE	APPLICABLE TO				DESCRIPTION
	RE≥1G	RE<1G	PLC	APCM	
-	√	√	√	√	-

Where **RE≥1G**: Radiated Emission above 1GHz      **RE<1G**: Radiated Emission below 1GHz  
**PLC**: Power Line Conducted Emission      **APCM**: Antenna Port Conducted Measurement

**NOTE:** The EUT had been pre-tested on the positioned of each 3 axis. The worst case was found when positioned on **X-plane**.

#### RADIATED EMISSION TEST (ABOVE 1GHz):

Pre-Scan has been conducted to determine the worst-case mode from all possible combinations between available modulations, data rates and antenna ports (if EUT with antenna diversity architecture).

Following channel(s) was (were) selected for the final test as listed below.

EUT CONFIGURE MODE	MODE	AVAILABLE CHANNEL	TESTED CHANNEL	MODULATION TECHNOLOGY	MODULATION TYPE	DATA RATE (Mbps)
-	802.11b	1 to 11	1, 6, 11	DSSS	DBPSK	1.0
-	802.11g	1 to 11	1, 6, 11	OFDM	BPSK	6.0
-	802.11n (20MHz)	1 to 11	1, 6, 11	OFDM	BPSK	MCS0
-	802.11n (40MHz)	3 to 9	3, 6, 9	OFDM	BPSK	MCS0

#### RADIATED EMISSION TEST (BELOW 1GHz):

Pre-Scan has been conducted to determine the worst-case mode from all possible combinations between available modulations, data rates and antenna ports (if EUT with antenna diversity architecture).

Following channel(s) was (were) selected for the final test as listed below.

EUT CONFIGURE MODE	MODE	AVAILABLE CHANNEL	TESTED CHANNEL	MODULATION TECHNOLOGY	MODULATION TYPE	DATA RATE (Mbps)
-	802.11b	1 to 11	6	DSSS	DBPSK	1.0

#### POWER LINE CONDUCTED EMISSION TEST:

EUT CONFIGURE MODE	MODE	AVAILABLE CHANNEL	TESTED CHANNEL	MODULATION TECHNOLOGY	MODULATION TYPE	DATA RATE (Mbps)
-	802.11b	1 to 11	6	DSSS	DBPSK	1.0



**BANDEDGE MEASUREMENT:**

- Pre-Scan has been conducted to determine the worst-case mode from all possible combinations between available modulations, data rates and antenna ports (if EUT with antenna diversity architecture).
- Following channel(s) was (were) selected for the final test as listed below.

EUT CONFIGURE MODE	MODE	AVAILABLE CHANNEL	TESTED CHANNEL	MODULATION TECHNOLOGY	MODULATION TYPE	DATA RATE (Mbps)
-	802.11b	1 to 11	1, 11	DSSS	DBPSK	1.0
-	802.11g	1 to 11	1, 11	OFDM	BPSK	6.0
-	802.11n (20MHz)	1 to 11	1, 11	OFDM	BPSK	MCS0
-	802.11n (40MHz)	3 to 9	3, 9	OFDM	BPSK	MCS0

**ANTENNA PORT CONDUCTED MEASUREMENT:**

- This item includes all test value of each mode, but only includes spectrum plot of worst value of each mode.
- Pre-Scan has been conducted to determine the worst-case mode from all possible combinations between available modulations, data rates and antenna ports (if EUT with antenna diversity architecture).
- Following channel(s) was (were) selected for the final test as listed below.

EUT CONFIGURE MODE	MODE	AVAILABLE CHANNEL	TESTED CHANNEL	MODULATION TECHNOLOGY	MODULATION TYPE	DATA RATE (Mbps)
-	802.11b	1 to 11	1, 6, 11	DSSS	DBPSK	1.0
-	802.11g	1 to 11	1, 6, 11	OFDM	BPSK	6.0
-	802.11n (20MHz)	1 to 11	1, 6, 11	OFDM	BPSK	MCS0
-	802.11n (40MHz)	3 to 9	3, 6, 9	OFDM	BPSK	MCS0

**TEST CONDITION:**

APPLICABLE TO	ENVIRONMENTAL CONDITIONS	INPUT POWER	TESTED BY
RE≥1G	25deg. C, 65%RH	120Vac, 60Hz	Gavin Wu
RE<1G	25deg. C, 65%RH	120Vac, 60Hz	Gavin Wu
PLC	25deg. C, 65%RH	120Vac, 60Hz	Peter Weng
APCM	25deg. C, 65%RH	120Vac, 60Hz	Howard Kao

### 3.3 DESCRIPTION OF SUPPORT UNITS

The EUT has been tested as an independent unit together with other necessary accessories or support units.

#### 3.3.1 CONFIGURATION OF SYSTEM UNDER TEST

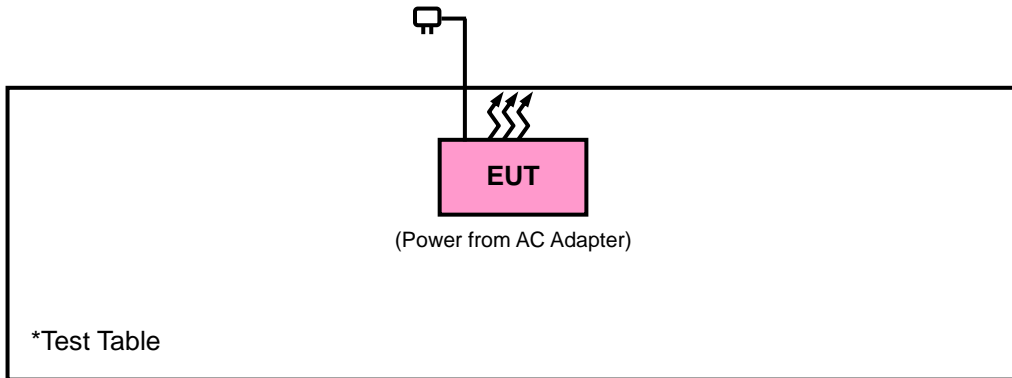



A D T

### 3.4 DUTY CYCLE TEST SIGNAL

#### WLAN 2.4GHz

**802.11b:** Duty cycle of test signal is 100 %

**802.11g:** Duty cycle of test signal is 100 %

**802.11n (20MHz):** Duty cycle of test signal is 100 %

**802.11n (40MHz):** Duty cycle of test signal is 100 %

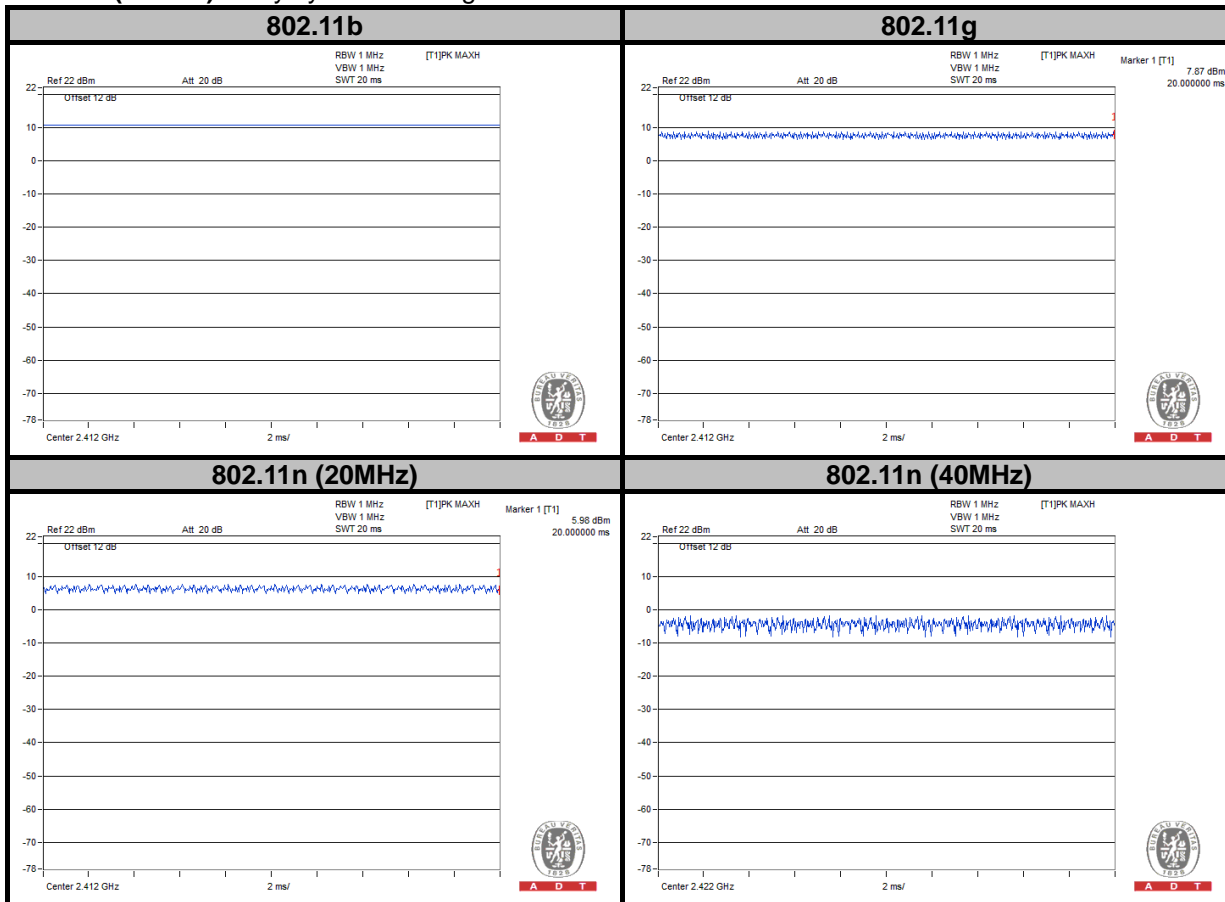

### 3.5 GENERAL DESCRIPTION OF APPLIED STANDARDS

The EUT is a RF Product. According to the specifications of the manufacturer, it must comply with the requirements of the following standards:

**FCC Part 15, Subpart C (15.247)**

**558074 D01 DTS Meas Guidance v03r02**

ANSI C63.10-2009

All test items have been performed and recorded as per the above standards.

**NOTE:** The EUT is also considered as a kind of computer peripheral, because the connection to computer is necessary for typical use. It has been verified to comply with the requirements of FCC Part 15, Subpart B, Class B (DoC). The test report has been issued separately.

## 4. TEST TYPES AND RESULTS (FOR 2.4GHz BAND)

### 4.1 RADIATED EMISSION AND BANDEDGE MEASUREMENT

#### 4.1.1 LIMITS OF RADIATED EMISSION AND BANDEDGE MEASUREMENT

Radiated emissions which fall in the restricted bands must comply with the radiated emission limits specified as below table. Other emissions shall be at least 20dB below the highest level of the desired power:

FREQUENCIES (MHz)	FIELD STRENGTH (microvolts/meter)	MEASUREMENT DISTANCE (meters)
0.009 ~ 0.490	2400/F(kHz)	300
0.490 ~ 1.705	24000/F(kHz)	30
1.705 ~ 30.0	30	30
30 ~ 88	100	3
88 ~ 216	150	3
216 ~ 960	200	3
Above 960	500	3

**NOTE:**

1. The lower limit shall apply at the transition frequencies.
2. Emission level (dBuV/m) = 20 log Emission level (uV/m).
3. For frequencies above 1000MHz, the field strength limits are based on average detector, however, the peak field strength of any emission shall not exceed the maximum permitted average limits, specified above by more than 20dB under any condition of modulation.



**4.1.2 TEST INSTRUMENTS**

DESCRIPTION & MANUFACTURER	MODEL NO.	SERIAL NO.	DATE OF CALIBRATION	DUE DATE OF CALIBRATION
Test Receiver ROHDE & SCHWARZ	ESCI	100412	Sep. 13, 2013	Sep. 12, 2014
Spectrum Analyzer ROHDE & SCHWARZ	FSU43	101261	Dec. 21, 2013	Dec. 20, 2014
BILOG Antenna SCHWARZBECK	VULB9168	9168-472	Feb. 27, 2014	Feb. 26, 2015
HORN Antenna SCHWARZBECK	BBHA 9120 D	9120D- 209	Sep. 12, 2013	Sep. 11, 2014
HORN Antenna SCHWARZBECK	BBHA 9170	9170-480	Dec. 18, 2013	Dec. 17, 2014
Loop Antenna	HFH2-Z2	100070	Mar. 06, 2014	Mar. 05, 2016
Preamplifier EMCI	EMC 012645	980115	Dec. 26, 2013	Dec. 25, 2014
Preamplifier EMCI	EMC 184045	980116	Jan. 13, 2014	Jan. 12, 2015
Preamplifier EMCI	EMC 330H	980112	Dec. 27, 2013	Dec. 26, 2014
RF signal cable HUBER+SUHNNER	SUCOFLEX 104	309219/4	Oct. 18, 2013	Oct. 17, 2014
RF signal cable HUBER+SUHNNER	SUCOFLEX 104	250130/4	Oct. 18, 2013	Oct. 17, 2014
RF signal cable Worken	RG-213	NA	Nov. 07, 2013	Nov. 06, 2014
Software BV ADT	E3 6.120103	NA	NA	NA
Antenna Tower MF	MFA-440H	NA	NA	NA
Turn Table MF	MFT-201SS	NA	NA	NA
Antenna Tower & Turn Table Controller MF	MF-7802	NA	NA	NA
Power Meter	ML2495A	1232002	Aug. 23, 2013	Aug. 22, 2014
Power Sensor	MA2411B	1207325	Aug. 23, 2013	Aug. 22, 2014

- NOTE:**
1. The calibration interval of the above test instruments is 12 months and the calibrations are traceable to NML/ROC and NIST/USA.
  2. The calibration interval of the loop antenna is 24 months and the calibrations are traceable to NML/ROC and NIST/USA.
  3. The test was performed in HwaYa Chamber 10.
  4. The horn antenna and HP preamplifier (model: 8449B) are used only for the measurement of emission frequency above 1GHz if tested.
  5. The FCC Site Registration No. is 690701.
  6. The IC Site Registration No. is IC 7450F-10.

#### 4.1.3 TEST PROCEDURES

- a. The EUT was placed on the top of a rotating table 0.8 meters above the ground at a 3 meters semi-anechoic chamber. The table was rotated 360 degrees to determine the position of the highest radiation.
- b. The EUT was set 3 meters away from the interference-receiving antenna, which was mounted on the top of a variable-height antenna tower.
- c. Height of receiving antenna is varied from one meter to four meters above the ground to determine the maximum value of the field strength. Both horizontal and vertical polarizations of the antenna are set to make the measurement.
- d. For each suspected emission, the EUT was arranged to its worst case and then the antenna was tuned to heights from 1 meter to 4 meters and the rotatable table was turned from 0 degrees to 360 degrees to find the maximum reading.
- e. The test-receiver system was set to Peak Detect Function and Specified Bandwidth with Maximum Hold Mode.
- f. If the emission level of the EUT in peak mode was lower than the limit specified, then testing could be stopped and the peak values of the EUT would be reported. Otherwise the emissions would be re-tested one by one using peak, quasi-peak or average method as specified and then reported in a data sheet.

**NOTE:**

1. The resolution bandwidth and video bandwidth of test receiver/spectrum analyzer is 120kHz for Quasi-peak detection at frequency below 1GHz.
2. The resolution bandwidth of test receiver/spectrum analyzer is 1MHz and video bandwidth is 3MHz for Peak detection at frequency above 1GHz.
3. The resolution bandwidth of test receiver/spectrum analyzer is 1MHz and the video bandwidth is 1kHz (Duty cycle < 98%) or 10Hz (Duty cycle > 98%) for Average detection (AV) at frequency above 1GHz.
4. All modes of operation were investigated and the worst-case emissions are reported.

#### 4.1.4 DEVIATION FROM TEST STANDARD

No deviation.



### 4.1.5 TEST SETUP

#### Frequency Range 30MHz ~ 1GHz

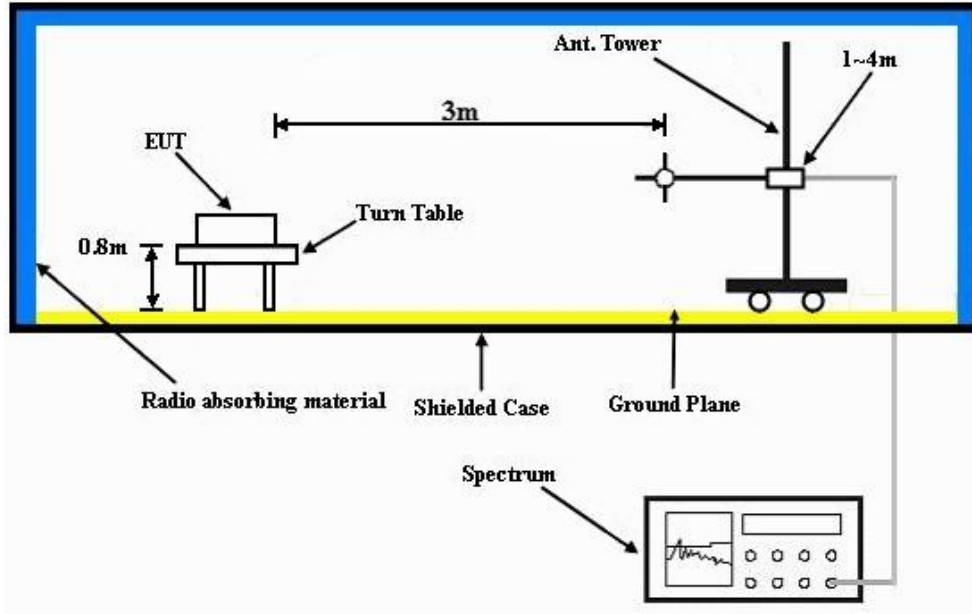

#### Frequency Range above 1GHz

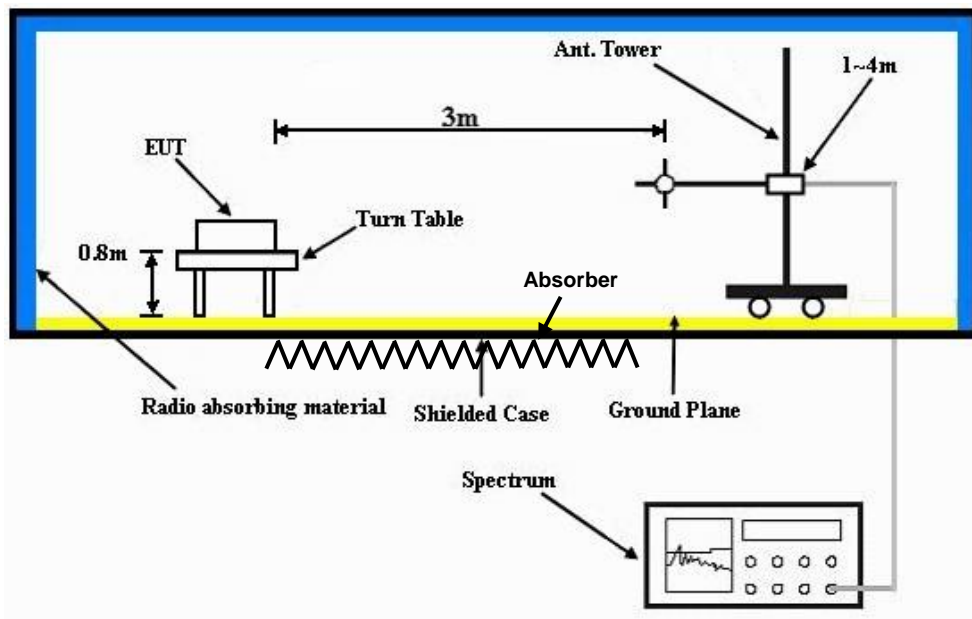

	Test volume(m)	d(m)	w(m)	h(m)
Validated	2	3	1.61	1~ 4m variable
EUT	2	3	1.61	1~ 4m variable

For the actual test configuration, please refer to the attached file (Test Setup Photo).



A D T

**4.1.6 EUT OPERATING CONDITIONS**

- a. Placed the EUT on a testing table.
- b. Use the software to control the EUT under transmission condition continuously at specific channel frequency.

**4.1.7 TEST RESULTS**

**ABOVE 1GHz WORST-CASE DATA**

**802.11b**

EUT TEST CONDITION		MEASUREMENT DETAIL	
CHANNEL	Channel 1	FREQUENCY RANGE	1GHz ~ 25GHz
INPUT POWER	120Vac, 60 Hz	DETECTOR FUNCTION	Peak (PK) Average (AV)
ENVIRONMENTAL CONDITIONS	25deg. C, 65%RH	TESTED BY	Gavin Wu

**ANTENNA POLARITY & TEST DISTANCE: HORIZONTAL AT 3 M**

FREQ. (MHz)	EMISSION LEVEL (dBuV/m)	READ LEVEL (dBuV)	LIMIT (dBuV/m)	MARGIN (dB)	ANTENNA FACTOR (dB/m)	CABLE LOSS (dB)	PREAMP FACTOR (dB)	ANTENNA HEIGHT (cm)	TABLE ANGLE (Degree)	REMARK
2390	49.69	56.76	54	-4.31	26.91	3.54	37.52	100	312	Average
2390	58.14	65.21	74	-15.86	26.91	3.54	37.52	100	312	Peak
2412	103.16	110.18			26.96	3.54	37.52	100	312	Average
2412	107.28	114.3			26.96	3.54	37.52	100	312	Peak
2488	38.68	45.18	54	-15.32	27.2	3.62	37.32	100	312	Average
2488	50.71	57.21	74	-23.29	27.2	3.62	37.32	100	312	Peak

**ANTENNA POLARITY & TEST DISTANCE: VERTICAL AT 3 M**

FREQ. (MHz)	EMISSION LEVEL (dBuV/m)	READ LEVEL (dBuV)	LIMIT (dBuV/m)	MARGIN (dB)	ANTENNA FACTOR (dB/m)	CABLE LOSS (dB)	PREAMP FACTOR (dB)	ANTENNA HEIGHT (cm)	TABLE ANGLE (Degree)	REMARK
2390	48.02	55.09	54	-5.98	26.91	3.54	37.52	100	360	Average
2390	57.06	64.13	74	-16.94	26.91	3.54	37.52	100	360	Peak
2412	101.07	108.09			26.96	3.54	37.52	100	360	Average
2412	105.13	112.15			26.96	3.54	37.52	100	360	Peak
2494	37.39	43.82	54	-16.61	27.2	3.62	37.25	100	360	Average
2494	50.03	56.46	74	-23.97	27.2	3.62	37.25	100	360	Peak
4824	39.25	55.57	54	-14.75	30.99	5.77	53.08	107	40	Average
4824	44.37	60.69	74	-29.63	30.99	5.77	53.08	107	40	Peak
7236	50.01	59.69	81.07	-31.06	35.68	6.65	52.01	107	40	Average
7236	55.9	65.58	85.13	-29.23	35.68	6.65	52.01	107	40	Peak

**REMARKS:**

1. Emission Level = Read Level + Antenna Factor + Cable Loss - Preamp Factor  
Margin value = Emission level – Limit value
2. 2412MHz: Fundamental frequency.
3. 7236MHz: Out of restricted band.



A D T

EUT TEST CONDITION		MEASUREMENT DETAIL	
CHANNEL	Channel 6	FREQUENCY RANGE	1GHz ~ 25GHz
INPUT POWER	120Vac, 60 Hz	DETECTOR FUNCTION	Peak (PK) Average (AV)
ENVIRONMENTAL CONDITIONS	25deg. C, 65%RH	TESTED BY	Gavin Wu

**ANTENNA POLARITY & TEST DISTANCE: HORIZONTAL AT 3 M**

FREQ. (MHz)	EMISSION LEVEL (dBuV/m)	READ LEVEL (dBuV)	LIMIT (dBuV/m)	MARGIN (dB)	ANTENNA FACTOR (dB/m)	CABLE LOSS (dB)	PREAMP FACTOR (dB)	ANTENNA HEIGHT (cm)	TABLE ANGLE (Degree)	REMARK
2372	36.24	43.36	54	-17.76	26.86	3.52	37.5	100	312	Average
2372	50.64	57.76	74	-23.36	26.86	3.52	37.5	100	312	Peak
2437	105.18	112.02			27.06	3.56	37.46	100	312	Average
2437	108.99	115.83			27.06	3.56	37.46	100	312	Peak
2484	37.32	43.89	54	-16.68	27.15	3.6	37.32	100	312	Average
2484	50.72	57.29	74	-23.28	27.15	3.6	37.32	100	312	Peak

**ANTENNA POLARITY & TEST DISTANCE: VERTICAL AT 3 M**

FREQ. (MHz)	EMISSION LEVEL (dBuV/m)	READ LEVEL (dBuV)	LIMIT (dBuV/m)	MARGIN (dB)	ANTENNA FACTOR (dB/m)	CABLE LOSS (dB)	PREAMP FACTOR (dB)	ANTENNA HEIGHT (cm)	TABLE ANGLE (Degree)	REMARK
2390	36.02	43.09	54	-17.98	26.91	3.54	37.52	100	360	Average
2390	50.18	57.25	74	-23.82	26.91	3.54	37.52	100	360	Peak
2437	102.14	108.98			27.06	3.56	37.46	100	360	Average
2437	106.96	113.8			27.06	3.56	37.46	100	360	Peak
2486	36.91	43.48	54	-17.09	27.15	3.6	37.32	100	360	Average
2486	50.62	57.19	74	-23.38	27.15	3.6	37.32	100	360	Peak
4874	40.33	56.52	54	-13.67	31.06	5.8	53.05	107	40	Average
4874	45.61	61.8	74	-28.39	31.06	5.8	53.05	107	40	Peak
<b>7311</b>	<b>51.25</b>	<b>60.58</b>	<b>54</b>	<b>-2.75</b>	<b>35.84</b>	<b>6.68</b>	<b>51.85</b>	<b>107</b>	<b>40</b>	<b>Average</b>
7311	54.4	63.73	74	-19.6	35.84	6.68	51.85	107	40	Peak

**REMARKS:**

- Emission Level = Read Level + Antenna Factor + Cable Loss - Preamp Factor  
Margin value = Emission level – Limit value
- 2437MHz: Fundamental frequency.



A D T

EUT TEST CONDITION		MEASUREMENT DETAIL	
CHANNEL	Channel 11	FREQUENCY RANGE	1GHz ~ 25GHz
INPUT POWER	120Vac, 60 Hz	DETECTOR FUNCTION	Peak (PK) Average (AV)
ENVIRONMENTAL CONDITIONS	25deg. C, 65%RH	TESTED BY	Gavin Wu

**ANTENNA POLARITY & TEST DISTANCE: HORIZONTAL AT 3 M**

FREQ. (MHz)	EMISSION LEVEL (dBuV/m)	READ LEVEL (dBuV)	LIMIT (dBuV/m)	MARGIN (dB)	ANTENNA FACTOR (dB/m)	CABLE LOSS (dB)	PREAMP FACTOR (dB)	ANTENNA HEIGHT (cm)	TABLE ANGLE (Degree)	REMARK
2350	37.39	44.61	54	-16.61	26.77	3.5	37.49	100	312	Average
2350	50.55	57.77	74	-23.45	26.77	3.5	37.49	100	312	Peak
2462	103.21	109.92			27.1	3.58	37.39	100	312	Average
2462	107.12	113.83			27.1	3.58	37.39	100	312	Peak
2483.5	47.74	54.31	54	-6.26	27.15	3.6	37.32	100	312	Average
2483.5	53.98	60.55	74	-20.02	27.15	3.6	37.32	100	312	Peak

**ANTENNA POLARITY & TEST DISTANCE: VERTICAL AT 3 M**

FREQ. (MHz)	EMISSION LEVEL (dBuV/m)	READ LEVEL (dBuV)	LIMIT (dBuV/m)	MARGIN (dB)	ANTENNA FACTOR (dB/m)	CABLE LOSS (dB)	PREAMP FACTOR (dB)	ANTENNA HEIGHT (cm)	TABLE ANGLE (Degree)	REMARK
2316	36.72	44.04	54	-17.28	26.67	3.48	37.47	100	360	Average
2316	49.83	57.15	74	-24.17	26.67	3.48	37.47	100	360	Peak
2462	101.25	107.96			27.1	3.58	37.39	100	360	Average
2462	105.37	112.08			27.1	3.58	37.39	100	360	Peak
2483.5	46.32	52.89	54	-7.68	27.15	3.6	37.32	100	360	Average
2483.5	52.4	58.97	74	-21.6	27.15	3.6	37.32	100	360	Peak
4925	41.47	57.55	54	-12.53	31.12	5.83	53.03	107	40	Average
4925	45.87	61.95	74	-28.13	31.12	5.83	53.03	107	40	Peak
7386	50.69	59.53	54	-3.31	36.05	6.71	51.6	107	40	Average
7386	56.67	65.51	74	-17.33	36.05	6.71	51.6	107	40	Peak

**REMARKS:**

- Emission Level = Read Level + Antenna Factor + Cable Loss - Preamp Factor  
Margin value = Emission level – Limit value
- 2462MHz: Fundamental frequency.



A D T

802.11g

EUT TEST CONDITION		MEASUREMENT DETAIL	
CHANNEL	Channel 1	FREQUENCY RANGE	1GHz ~ 25GHz
INPUT POWER	120Vac, 60 Hz	DETECTOR FUNCTION	Peak (PK) Average (AV)
ENVIRONMENTAL CONDITIONS	25deg. C, 65%RH	TESTED BY	Gavin Wu

ANTENNA POLARITY & TEST DISTANCE: HORIZONTAL AT 3 M

FREQ. (MHz)	EMISSION LEVEL (dBuV/m)	READ LEVEL (dBuV)	LIMIT (dBuV/m)	MARGIN (dB)	ANTENNA FACTOR (dB/m)	CABLE LOSS (dB)	PREAMP FACTOR (dB)	ANTENNA HEIGHT (cm)	TABLE ANGLE (Degree)	REMARK
2390	41.02	48.09	54	-12.98	26.91	3.54	37.52	100	312	Average
2390	53.7	60.77	74	-20.3	26.91	3.54	37.52	100	312	Peak
2412	93.02	100.04			26.96	3.54	37.52	100	312	Average
2412	101.22	108.24			26.96	3.54	37.52	100	312	Peak
2490	35.39	41.89	54	-18.61	27.2	3.62	37.32	100	312	Average
2490	50.21	56.71	74	-23.79	27.2	3.62	37.32	100	312	Peak

ANTENNA POLARITY & TEST DISTANCE: VERTICAL AT 3 M

FREQ. (MHz)	EMISSION LEVEL (dBuV/m)	READ LEVEL (dBuV)	LIMIT (dBuV/m)	MARGIN (dB)	ANTENNA FACTOR (dB/m)	CABLE LOSS (dB)	PREAMP FACTOR (dB)	ANTENNA HEIGHT (cm)	TABLE ANGLE (Degree)	REMARK
2390	38.31	45.38	54	-15.69	26.91	3.54	37.52	100	360	Average
2390	51.66	58.73	74	-22.34	26.91	3.54	37.52	100	360	Peak
2412	90.37	97.39			26.96	3.54	37.52	100	360	Average
2412	99.08	106.1			26.96	3.54	37.52	100	360	Peak
2484	39.32	45.89	54	-14.68	27.15	3.6	37.32	100	360	Average
2484	50.84	57.41	74	-23.16	27.15	3.6	37.32	100	360	Peak

REMARKS:

- Emission Level = Read Level + Antenna Factor + Cable Loss - Preamp Factor  
Margin value = Emission level – Limit value
- 2412MHz: Fundamental frequency.



A D T

EUT TEST CONDITION		MEASUREMENT DETAIL	
CHANNEL	Channel 6	FREQUENCY RANGE	1GHz ~ 25GHz
INPUT POWER	120Vac, 60 Hz	DETECTOR FUNCTION	Peak (PK) Average (AV)
ENVIRONMENTAL CONDITIONS	25deg. C, 65%RH	TESTED BY	Gavin Wu

ANTENNA POLARITY & TEST DISTANCE: HORIZONTAL AT 3 M										
FREQ. (MHz)	EMISSION LEVEL (dBuV/m)	READ LEVEL (dBuV)	LIMIT (dBuV/m)	MARGIN (dB)	ANTENNA FACTOR (dB/m)	CABLE LOSS (dB)	PREAMP FACTOR (dB)	ANTENNA HEIGHT (cm)	TABLE ANGLE (Degree)	REMARK
2380	34.94	42.06	54	-19.06	26.86	3.52	37.5	100	312	Average
2380	50.42	57.54	74	-23.58	26.86	3.52	37.5	100	312	Peak
2437	92.14	98.98			27.06	3.56	37.46	100	312	Average
2437	101.75	108.59			27.06	3.56	37.46	100	312	Peak
2500	35.39	41.82	54	-18.61	27.2	3.62	37.25	100	312	Average
2500	50.9	57.33	74	-23.1	27.2	3.62	37.25	100	312	Peak
ANTENNA POLARITY & TEST DISTANCE: VERTICAL AT 3 M										
FREQ. (MHz)	EMISSION LEVEL (dBuV/m)	READ LEVEL (dBuV)	LIMIT (dBuV/m)	MARGIN (dB)	ANTENNA FACTOR (dB/m)	CABLE LOSS (dB)	PREAMP FACTOR (dB)	ANTENNA HEIGHT (cm)	TABLE ANGLE (Degree)	REMARK
2390	33.98	41.05	54	-20.02	26.91	3.54	37.52	100	360	Average
2390	51.19	58.26	74	-22.81	26.91	3.54	37.52	100	360	Peak
2437	90.48	97.32			27.06	3.56	37.46	100	360	Average
2437	99.68	106.52			27.06	3.56	37.46	100	360	Peak
2488	36.07	42.57	54	-17.93	27.2	3.62	37.32	100	360	Average
2488	51.06	57.56	74	-22.94	27.2	3.62	37.32	100	360	Peak

**REMARKS:**

- Emission Level = Read Level + Antenna Factor + Cable Loss - Preamp Factor  
Margin value = Emission level – Limit value
- 2437MHz: Fundamental frequency.



A D T

EUT TEST CONDITION		MEASUREMENT DETAIL	
CHANNEL	Channel 11	FREQUENCY RANGE	1GHz ~ 25GHz
INPUT POWER	120Vac, 60 Hz	DETECTOR FUNCTION	Peak (PK) Average (AV)
ENVIRONMENTAL CONDITIONS	25deg. C, 65%RH	TESTED BY	Gavin Wu

**ANTENNA POLARITY & TEST DISTANCE: HORIZONTAL AT 3 M**

FREQ. (MHz)	EMISSION LEVEL (dBuV/m)	READ LEVEL (dBuV)	LIMIT (dBuV/m)	MARGIN (dB)	ANTENNA FACTOR (dB/m)	CABLE LOSS (dB)	PREAMP FACTOR (dB)	ANTENNA HEIGHT (cm)	TABLE ANGLE (Degree)	REMARK
2366	33.9	41.07	54	-20.1	26.81	3.52	37.5	100	312	Average
2366	51.49	58.66	74	-22.51	26.81	3.52	37.5	100	312	Peak
2462	93.21	99.92			27.1	3.58	37.39	100	312	Average
2462	101.97	108.68			27.1	3.58	37.39	100	312	Peak
2492	35.68	42.11	54	-18.32	27.2	3.62	37.25	100	312	Average
2492	55.39	61.82	74	-18.61	27.2	3.62	37.25	100	312	Peak

**ANTENNA POLARITY & TEST DISTANCE: VERTICAL AT 3 M**

FREQ. (MHz)	EMISSION LEVEL (dBuV/m)	READ LEVEL (dBuV)	LIMIT (dBuV/m)	MARGIN (dB)	ANTENNA FACTOR (dB/m)	CABLE LOSS (dB)	PREAMP FACTOR (dB)	ANTENNA HEIGHT (cm)	TABLE ANGLE (Degree)	REMARK
2350	33.83	41.05	54	-20.17	26.77	3.5	37.49	100	360	Average
2350	51.02	58.24	74	-22.98	26.77	3.5	37.49	100	360	Peak
2462	90.25	96.96			27.1	3.58	37.39	100	360	Average
2462	98.59	105.3			27.1	3.58	37.39	100	360	Peak
2488	36.39	42.89	54	-17.61	27.2	3.62	37.32	100	360	Average
2488	56.66	63.16	74	-17.34	27.2	3.62	37.32	100	360	Peak

**REMARKS:**

- Emission Level = Read Level + Antenna Factor + Cable Loss - Preamp Factor  
Margin value = Emission level – Limit value
- 2462MHz: Fundamental frequency.



A D T

802.11n (20MHz)

EUT TEST CONDITION		MEASUREMENT DETAIL	
CHANNEL	Channel 1	FREQUENCY RANGE	1GHz ~ 25GHz
INPUT POWER	120Vac, 60 Hz	DETECTOR FUNCTION	Peak (PK) Average (AV)
ENVIRONMENTAL CONDITIONS	25deg. C, 65%RH	TESTED BY	Gavin Wu

ANTENNA POLARITY & TEST DISTANCE: HORIZONTAL AT 3 M

FREQ. (MHz)	EMISSION LEVEL (dBuV/m)	READ LEVEL (dBuV)	LIMIT (dBuV/m)	MARGIN (dB)	ANTENNA FACTOR (dB/m)	CABLE LOSS (dB)	PREAMP FACTOR (dB)	ANTENNA HEIGHT (cm)	TABLE ANGLE (Degree)	REMARK
2340	36.83	44.05	54	-17.17	26.77	3.5	37.49	100	311	Average
2340	50.83	58.05	74	-23.17	26.77	3.5	37.49	100	311	Peak
2412	92.02	99.04			26.96	3.54	37.52	100	311	Average
2412	100.03	107.05			26.96	3.54	37.52	100	311	Peak
2496	37.68	44.11	54	-16.32	27.2	3.62	37.25	100	311	Average
2496	50.12	56.55	74	-23.88	27.2	3.62	37.25	100	311	Peak

ANTENNA POLARITY & TEST DISTANCE: VERTICAL AT 3 M

FREQ. (MHz)	EMISSION LEVEL (dBuV/m)	READ LEVEL (dBuV)	LIMIT (dBuV/m)	MARGIN (dB)	ANTENNA FACTOR (dB/m)	CABLE LOSS (dB)	PREAMP FACTOR (dB)	ANTENNA HEIGHT (cm)	TABLE ANGLE (Degree)	REMARK
2378	38.23	45.35	54	-15.77	26.86	3.52	37.5	100	360	Average
2378	50.23	57.35	74	-23.77	26.86	3.52	37.5	100	360	Peak
2412	89.74	96.76			26.96	3.54	37.52	100	360	Average
2412	97.78	104.8			26.96	3.54	37.52	100	360	Peak
2490	37.39	43.89	54	-16.61	27.2	3.62	37.32	100	360	Average
2490	50.6	57.1	74	-23.4	27.2	3.62	37.32	100	360	Peak

REMARKS:

- Emission Level = Read Level + Antenna Factor + Cable Loss - Preamp Factor  
Margin value = Emission level – Limit value
- 2412MHz: Fundamental frequency.





A D T

EUT TEST CONDITION		MEASUREMENT DETAIL	
CHANNEL	Channel 6	FREQUENCY RANGE	1GHz ~ 25GHz
INPUT POWER	120Vac, 60 Hz	DETECTOR FUNCTION	Peak (PK) Average (AV)
ENVIRONMENTAL CONDITIONS	25deg. C, 65%RH	TESTED BY	Gavin Wu

ANTENNA POLARITY & TEST DISTANCE: HORIZONTAL AT 3 M										
FREQ. (MHz)	EMISSION LEVEL (dBuV/m)	READ LEVEL (dBuV)	LIMIT (dBuV/m)	MARGIN (dB)	ANTENNA FACTOR (dB/m)	CABLE LOSS (dB)	PREAMP FACTOR (dB)	ANTENNA HEIGHT (cm)	TABLE ANGLE (Degree)	REMARK
2384	35.95	43.07	54	-18.05	26.86	3.52	37.5	100	312	Average
2384	50.6	57.72	74	-23.4	26.86	3.52	37.5	100	312	Peak
2437	92.18	99.02			27.06	3.56	37.46	100	312	Average
2437	100.53	107.37			27.06	3.56	37.46	100	312	Peak
2500	37.95	44.38	54	-16.05	27.2	3.62	37.25	100	312	Average
2500	50.49	56.92	74	-23.51	27.2	3.62	37.25	100	312	Peak

ANTENNA POLARITY & TEST DISTANCE: VERTICAL AT 3 M										
FREQ. (MHz)	EMISSION LEVEL (dBuV/m)	READ LEVEL (dBuV)	LIMIT (dBuV/m)	MARGIN (dB)	ANTENNA FACTOR (dB/m)	CABLE LOSS (dB)	PREAMP FACTOR (dB)	ANTENNA HEIGHT (cm)	TABLE ANGLE (Degree)	REMARK
2368	36.86	44.03	54	-17.14	26.81	3.52	37.5	100	360	Average
2368	49.78	56.95	74	-24.22	26.81	3.52	37.5	100	360	Peak
2437	90.3	97.14			27.06	3.56	37.46	100	360	Average
2437	98.32	105.16			27.06	3.56	37.46	100	360	Peak
2494	36.41	42.84	54	-17.59	27.2	3.62	37.25	100	360	Average
2494	49.84	56.27	74	-24.16	27.2	3.62	37.25	100	360	Peak

**REMARKS:**

- Emission Level = Read Level + Antenna Factor + Cable Loss - Preamp Factor  
Margin value = Emission level – Limit value
- 2437MHz: Fundamental frequency.



A D T

EUT TEST CONDITION		MEASUREMENT DETAIL	
CHANNEL	Channel 11	FREQUENCY RANGE	1GHz ~ 25GHz
INPUT POWER	120Vac, 60 Hz	DETECTOR FUNCTION	Peak (PK) Average (AV)
ENVIRONMENTAL CONDITIONS	25deg. C, 65%RH	TESTED BY	Gavin Wu

**ANTENNA POLARITY & TEST DISTANCE: HORIZONTAL AT 3 M**

FREQ. (MHz)	EMISSION LEVEL (dBuV/m)	READ LEVEL (dBuV)	LIMIT (dBuV/m)	MARGIN (dB)	ANTENNA FACTOR (dB/m)	CABLE LOSS (dB)	PREAMP FACTOR (dB)	ANTENNA HEIGHT (cm)	TABLE ANGLE (Degree)	REMARK
2344	36.81	44.03	54	-17.19	26.77	3.5	37.49	100	312	Average
2344	49.97	57.19	74	-24.03	26.77	3.5	37.49	100	312	Peak
2462	93.25	99.96			27.1	3.58	37.39	100	312	Average
2462	100.98	107.69			27.1	3.58	37.39	100	312	Peak
2483.5	39.74	46.31	54	-14.26	27.15	3.6	37.32	100	312	Average
2483.5	52.07	58.64	74	-21.93	27.15	3.6	37.32	100	312	Peak

**ANTENNA POLARITY & TEST DISTANCE: VERTICAL AT 3 M**

FREQ. (MHz)	EMISSION LEVEL (dBuV/m)	READ LEVEL (dBuV)	LIMIT (dBuV/m)	MARGIN (dB)	ANTENNA FACTOR (dB/m)	CABLE LOSS (dB)	PREAMP FACTOR (dB)	ANTENNA HEIGHT (cm)	TABLE ANGLE (Degree)	REMARK
2352	36.87	44.05	54	-17.13	26.81	3.5	37.49	100	360	Average
2352	50.16	57.34	74	-23.84	26.81	3.5	37.49	100	360	Peak
2462	90.58	97.29			27.1	3.58	37.39	100	360	Average
2462	97.65	104.36			27.1	3.58	37.39	100	360	Peak
2483.5	38.64	45.21	54	-15.36	27.15	3.6	37.32	100	360	Average
2483.5	52.16	58.73	74	-21.84	27.15	3.6	37.32	100	360	Peak

**REMARKS:**

- Emission Level = Read Level + Antenna Factor + Cable Loss - Preamp Factor  
Margin value = Emission level – Limit value
- 2462MHz: Fundamental frequency.



A D T

**802.11n (40MHz)**

EUT TEST CONDITION		MEASUREMENT DETAIL	
CHANNEL	Channel 3	FREQUENCY RANGE	1GHz ~ 25GHz
INPUT POWER	120Vac, 60 Hz	DETECTOR FUNCTION	Peak (PK) Average (AV)
ENVIRONMENTAL CONDITIONS	25deg. C, 65%RH	TESTED BY	Gavin Wu

ANTENNA POLARITY & TEST DISTANCE: HORIZONTAL AT 3 M										
FREQ. (MHz)	EMISSION LEVEL (dBuV/m)	READ LEVEL (dBuV)	LIMIT (dBuV/m)	MARGIN (dB)	ANTENNA FACTOR (dB/m)	CABLE LOSS (dB)	PREAMP FACTOR (dB)	ANTENNA HEIGHT (cm)	TABLE ANGLE (Degree)	REMARK
2390	38.34	45.41	54	-15.66	26.91	3.54	37.52	100	312	Average
2390	51.12	58.19	74	-22.88	26.91	3.54	37.52	100	312	Peak
2422	88.13	95.02			27.01	3.56	37.46	100	312	Average
2422	96.59	103.48			27.01	3.56	37.46	100	312	Peak
2488	37.37	43.87	54	-16.63	27.2	3.62	37.32	100	312	Average
2488	50.5	57	74	-23.5	27.2	3.62	37.32	100	312	Peak
ANTENNA POLARITY & TEST DISTANCE: VERTICAL AT 3 M										
FREQ. (MHz)	EMISSION LEVEL (dBuV/m)	READ LEVEL (dBuV)	LIMIT (dBuV/m)	MARGIN (dB)	ANTENNA FACTOR (dB/m)	CABLE LOSS (dB)	PREAMP FACTOR (dB)	ANTENNA HEIGHT (cm)	TABLE ANGLE (Degree)	REMARK
2324	36.75	44.02	54	-17.25	26.72	3.48	37.47	100	360	Average
2324	50.76	58.03	74	-23.24	26.72	3.48	37.47	100	360	Peak
2422	86.02	92.91			27.01	3.56	37.46	100	360	Average
2422	93.98	100.87			27.01	3.56	37.46	100	360	Peak
2492	37.41	43.84	54	-16.59	27.2	3.62	37.25	100	360	Average
2492	50.31	56.74	74	-23.69	27.2	3.62	37.25	100	360	Peak

**REMARKS:**

- Emission Level = Read Level + Antenna Factor + Cable Loss - Preamp Factor  
Margin value = Emission level – Limit value
- 2422MHz: Fundamental frequency.



A D T

EUT TEST CONDITION		MEASUREMENT DETAIL	
CHANNEL	Channel 6	FREQUENCY RANGE	1GHz ~ 25GHz
INPUT POWER	120Vac, 60 Hz	DETECTOR FUNCTION	Peak (PK) Average (AV)
ENVIRONMENTAL CONDITIONS	25deg. C, 65%RH	TESTED BY	Gavin Wu

**ANTENNA POLARITY & TEST DISTANCE: HORIZONTAL AT 3 M**

FREQ. (MHz)	EMISSION LEVEL (dBuV/m)	READ LEVEL (dBuV)	LIMIT (dBuV/m)	MARGIN (dB)	ANTENNA FACTOR (dB/m)	CABLE LOSS (dB)	PREAMP FACTOR (dB)	ANTENNA HEIGHT (cm)	TABLE ANGLE (Degree)	REMARK
2364	36.22	43.38	54	-17.78	26.81	3.52	37.49	100	312	Average
2364	50.05	57.21	74	-23.95	26.81	3.52	37.49	100	312	Peak
2437	88.47	95.31			27.06	3.56	37.46	100	312	Average
2437	96.74	103.58			27.06	3.56	37.46	100	312	Peak
2496	38.68	45.11	54	-15.32	27.2	3.62	37.25	100	312	Average
2496	50.27	56.7	74	-23.73	27.2	3.62	37.25	100	312	Peak

**ANTENNA POLARITY & TEST DISTANCE: VERTICAL AT 3 M**

FREQ. (MHz)	EMISSION LEVEL (dBuV/m)	READ LEVEL (dBuV)	LIMIT (dBuV/m)	MARGIN (dB)	ANTENNA FACTOR (dB/m)	CABLE LOSS (dB)	PREAMP FACTOR (dB)	ANTENNA HEIGHT (cm)	TABLE ANGLE (Degree)	REMARK
2374	36.28	43.4	54	-17.72	26.86	3.52	37.5	100	360	Average
2374	50.08	57.2	74	-23.92	26.86	3.52	37.5	100	360	Peak
2437	86.07	92.91			27.06	3.56	37.46	100	360	Average
2437	94.72	101.56			27.06	3.56	37.46	100	360	Peak
2488	38.28	44.78	54	-15.72	27.2	3.62	37.32	100	360	Average
2488	50.88	57.38	74	-23.12	27.2	3.62	37.32	100	360	Peak

**REMARKS:**

- Emission Level = Read Level + Antenna Factor + Cable Loss - Preamp Factor  
Margin value = Emission level – Limit value
- 2437MHz: Fundamental frequency.



A D T

EUT TEST CONDITION		MEASUREMENT DETAIL	
CHANNEL	Channel 9	FREQUENCY RANGE	1GHz ~ 25GHz
INPUT POWER	120Vac, 60 Hz	DETECTOR FUNCTION	Peak (PK) Average (AV)
ENVIRONMENTAL CONDITIONS	25deg. C, 65%RH	TESTED BY	Gavin Wu

**ANTENNA POLARITY & TEST DISTANCE: HORIZONTAL AT 3 M**

FREQ. (MHz)	EMISSION LEVEL (dBuV/m)	READ LEVEL (dBuV)	LIMIT (dBuV/m)	MARGIN (dB)	ANTENNA FACTOR (dB/m)	CABLE LOSS (dB)	PREAMP FACTOR (dB)	ANTENNA HEIGHT (cm)	TABLE ANGLE (Degree)	REMARK
2388	37.12	44.17	54	-16.88	26.91	3.54	37.5	100	312	Average
2388	50.37	57.42	74	-23.63	26.91	3.54	37.5	100	312	Peak
2452	87.2	93.95			27.06	3.58	37.39	100	312	Average
2452	96.67	103.42			27.06	3.58	37.39	100	312	Peak
2490	40.72	47.22	54	-13.28	27.2	3.62	37.32	100	312	Average
2490	51.59	58.09	74	-22.41	27.2	3.62	37.32	100	312	Peak

**ANTENNA POLARITY & TEST DISTANCE: VERTICAL AT 3 M**

FREQ. (MHz)	EMISSION LEVEL (dBuV/m)	READ LEVEL (dBuV)	LIMIT (dBuV/m)	MARGIN (dB)	ANTENNA FACTOR (dB/m)	CABLE LOSS (dB)	PREAMP FACTOR (dB)	ANTENNA HEIGHT (cm)	TABLE ANGLE (Degree)	REMARK
2326	35.76	43.03	54	-18.24	26.72	3.48	37.47	100	360	Average
2326	50.28	57.55	74	-23.72	26.72	3.48	37.47	100	360	Peak
2452	85.26	92.01			27.06	3.58	37.39	100	360	Average
2452	94.42	101.17			27.06	3.58	37.39	100	360	Peak
2486	38.34	44.91	54	-15.66	27.15	3.6	37.32	100	360	Average
2486	51.69	58.26	74	-22.31	27.15	3.6	37.32	100	360	Peak

**REMARKS:**

- Emission Level = Read Level + Antenna Factor + Cable Loss - Preamp Factor  
Margin value = Emission level – Limit value
- 2452MHz: Fundamental frequency.



A D T

**BELOW 1GHz WORST-CASE DATA:**

**802.11b**

EUT TEST CONDITION		MEASUREMENT DETAIL	
CHANNEL	Channel 6	FREQUENCY RANGE	30MHz ~ 1GHz
INPUT POWER	120Vac, 60 Hz	DETECTOR FUNCTION	Peak (PK) Average (AV)
ENVIRONMENTAL CONDITIONS	25deg. C, 65%RH	TESTED BY	Gavin Wu

**ANTENNA POLARITY & TEST DISTANCE: HORIZONTAL AT 3 M**

FREQ. (MHz)	EMISSION LEVEL (dBuV/m)	READ LEVEL (dBuV)	LIMIT (dBuV/m)	MARGIN (dB)	ANTENNA FACTOR (dB/m)	CABLE LOSS (dB)	PREAMP FACTOR (dB)	ANTENNA HEIGHT (cm)	TABLE ANGLE (Degree)	REMARK
116.94	32.4	52.37	43.5	-11.1	10.74	1.17	31.88	156	210	Peak
199.83	39.62	60.44	43.5	-3.88	9.36	1.59	31.77	100	165	Peak
240.06	42.3	61.23	46	-3.7	11.07	1.79	31.79	166	214	Peak
400.1	33.24	47.58	46	-12.76	15.35	2.43	32.12	135	165	Peak
599.6	42.32	51.88	46	-3.68	19.59	3.09	32.24	154	175	Peak
689.9	33	40.76	46	-13	20.69	3.39	31.84	124	124	Peak

**ANTENNA POLARITY & TEST DISTANCE: VERTICAL AT 3 M**

FREQ. (MHz)	EMISSION LEVEL (dBuV/m)	READ LEVEL (dBuV)	LIMIT (dBuV/m)	MARGIN (dB)	ANTENNA FACTOR (dB/m)	CABLE LOSS (dB)	PREAMP FACTOR (dB)	ANTENNA HEIGHT (cm)	TABLE ANGLE (Degree)	REMARK
60.78	31.06	49.82	40	-8.94	11.82	0.83	31.41	165	185	Peak
109.92	28.93	49.66	43.5	-14.57	9.99	1.12	31.84	124	129	Peak
200.1	35.73	56.55	43.5	-7.77	9.36	1.59	31.77	135	139	Peak
400.1	35.02	49.36	46	-10.98	15.35	2.43	32.12	157	148	Peak
599.6	42.48	52.04	46	-3.52	19.59	3.09	32.24	105	142	Peak
898.5	40.22	44.78	46	-5.78	23.49	3.96	32.01	199	156	Peak

**REMARKS:** Emission Level = Read Level + Antenna Factor + Cable Loss - Preamp Factor

Margin value = Emission level – Limit value

## 4.2 CONDUCTED EMISSION MEASUREMENT

### 4.2.1 LIMITS OF CONDUCTED EMISSION MEASUREMENT

FREQUENCY OF EMISSION (MHz)	CONDUCTED LIMIT (dB $\mu$ V)	
	Quasi-peak	Average
0.15 ~ 0.5	66 to 56	56 to 46
0.5 ~ 5	56	46
5 ~ 30	60	50

- NOTE:**
1. The lower limit shall apply at the transition frequencies.
  2. The limit decreases in line with the logarithm of the frequency in the range of 0.15 to 0.50MHz.
  3. All emanations from a class A/B digital device or system, including any network of conductors and apparatus connected thereto, shall not exceed the level of field strengths specified above.

### 4.2.2 TEST INSTRUMENTS

Test Date: Jul. 03, 2014

DESCRIPTION & MANUFACTURER	MODEL NO.	SERIAL NO.	DATE OF CALIBRATION	DUE DATE OF CALIBRATION
Test Receiver ROHDE & SCHWARZ	ESCS30	100288	Apr. 24, 2014	Apr. 23, 2015
RF signal cable Woken	5D-FB	Cable-HYCO2-01	Dec. 27, 2013	Dec. 26, 2014
LISN ROHDE & SCHWARZ (EUT)	ESH2-Z5	100100	Dec. 23, 2013	Dec. 22, 2014
LISN ROHDE & SCHWARZ (Peripheral)	ESH3-Z5	100312	Jul. 08, 2013	Jul. 07, 2014
Software ADT	BV ADT_Cond_ V7.3.7.3	NA	NA	NA

- NOTE:**
1. The calibration interval of the above test instruments is 12 months and the calibrations are traceable to NML/ROC and NIST/USA.
  2. The test was performed in HwaYa Shielded Room 2.
  3. The VCCI Site Registration No. is C-2047.

#### 4.2.3 TEST PROCEDURES

- a. The EUT was placed 0.4 meters from the conducting wall of the shielded room with EUT being connected to the power mains through a line impedance stabilization network (LISN). Other support units were connected to the power mains through another LISN. The two LISNs provide 50 ohm/ 50uH of coupling impedance for the measuring instrument.
- b. Both lines of the power mains connected to the EUT were checked for maximum conducted interference.
- c. The frequency range from 150kHz to 30MHz was searched. Emission levels under (Limit - 20dB) was not recorded.

**NOTE:** All modes of operation were investigated and the worst-case emissions are reported.

#### 4.2.4 DEVIATION FROM TEST STANDARD

No deviation.



#### 4.2.5 TEST SETUP

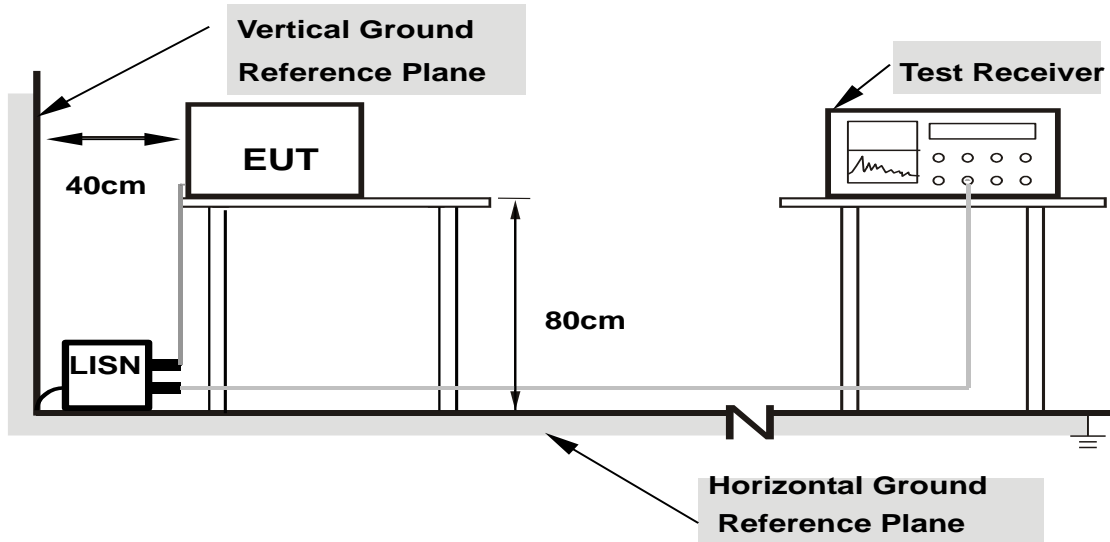

- Note:**
- 1.Support units were connected to second LISN.
  - 2.Both of LISNs (AMN) are 80 cm from EUT and at least 80 from other units and other metal planes

For the actual test configuration, please refer to the attached file (Test Setup Photo).

#### 4.2.6 EUT OPERATING CONDITIONS

Same as section 4.1.6.

4.2.7 TEST RESULTS

CONDUCTED WORST-CASE DATA :

PHASE	Line 1	6dB BANDWIDTH	9kHz
-------	--------	---------------	------

No	Freq.	Corr. Factor	Reading Value		Emission Level		Limit		Margin	
	[MHz]		[dB (uV)]		[dB (uV)]		[dB (uV)]		(dB)	
			Q.P.	AV.	Q.P.	AV.	Q.P.	AV.	Q.P.	AV.
1	0.18125	0.27	37.66	26.42	37.93	26.69	64.43	54.43	-26.49	-27.73
2	0.34922	0.29	31.28	22.11	31.57	22.40	58.98	48.98	-27.41	-26.58
<b>3</b>	<b>0.52500</b>	<b>0.31</b>	<b>39.94</b>	<b>31.64</b>	<b>40.25</b>	<b>31.95</b>	<b>56.00</b>	<b>46.00</b>	<b>-15.75</b>	<b>-14.05</b>
4	2.00000	0.36	26.99	19.36	27.35	19.72	56.00	46.00	-28.65	-26.28
5	6.79297	0.46	22.48	16.51	22.94	16.97	60.00	50.00	-37.06	-33.03
6	15.53125	0.54	30.13	23.49	30.67	24.03	60.00	50.00	-29.33	-25.97

REMARKS:

1. Q.P. and AV. are abbreviations of quasi-peak and average individually.
2. The emission levels of other frequencies were very low against the limit.
3. Margin value = Emission level - Limit value
4. Correction factor = Insertion loss + Cable loss
5. Emission Level = Correction Factor + Reading Value

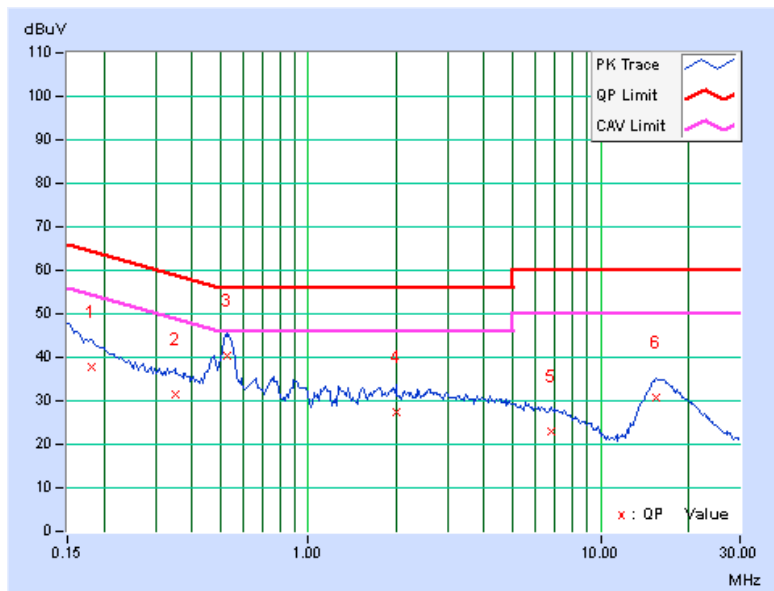

PHASE	Line 2	6dB BANDWIDTH	9kHz
-------	--------	---------------	------

No	Freq. [MHz]	Corr. Factor (dB)	Reading Value [dB (uV)]		Emission Level [dB (uV)]		Limit [dB (uV)]		Margin (dB)	
			Q.P.	AV.	Q.P.	AV.	Q.P.	AV.	Q.P.	AV.
			1	0.21641	0.28	34.20	20.02	34.48	20.30	62.96
2	0.29063	0.29	31.18	18.87	31.47	19.16	60.51	50.51	-29.04	-31.35
3	0.52500	0.31	34.27	26.25	34.58	26.56	56.00	46.00	-21.42	-19.44
4	1.78906	0.36	24.36	16.54	24.72	16.90	56.00	46.00	-31.28	-29.10
5	7.21094	0.48	18.04	10.67	18.52	11.15	60.00	50.00	-41.48	-38.85
6	15.37109	0.57	23.94	18.84	24.51	19.41	60.00	50.00	-35.49	-30.59

**REMARKS:**

1. Q.P. and AV. are abbreviations of quasi-peak and average individually.
2. The emission levels of other frequencies were very low against the limit.
3. Margin value = Emission level - Limit value
4. Correction factor = Insertion loss + Cable loss
5. Emission Level = Correction Factor + Reading Value

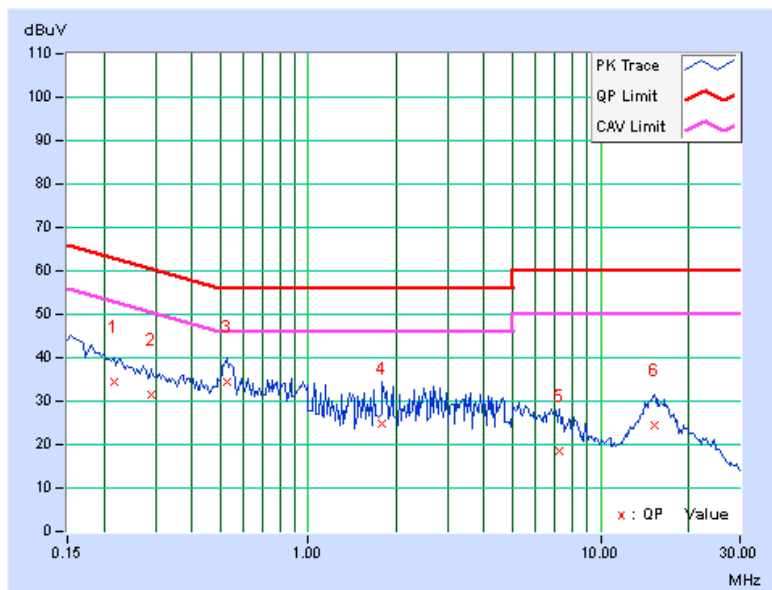

## 4.3 6dB BANDWIDTH MEASUREMENT

### 4.3.1 LIMITS OF 6dB BANDWIDTH MEASUREMENT

The minimum of 6dB Bandwidth Measurement is 0.5 MHz.

### 4.3.2 TEST SETUP

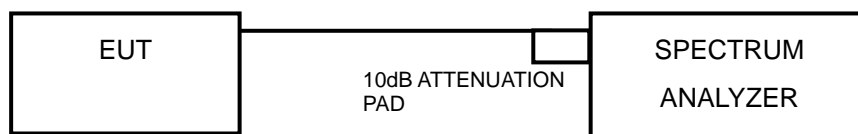

### 4.3.3 TEST INSTRUMENTS

Refer to section 4.1.2 to get information of above instrument.

### 4.3.4 TEST PROCEDURE

- Set resolution bandwidth (RBW) = 100kHz
- Set the video bandwidth (VBW)  $\geq 3 \times$  RBW, Detector = Peak.
- Trace mode = max hold.
- Sweep = auto couple.
- Measure the maximum width of the emission that is constrained by the frequencies associated with the two amplitude points (upper and lower) that are attenuated by 6 dB relative to the maximum level measured in the fundamental emission

### 4.3.5 DEVIATION FROM TEST STANDARD

No deviation.

### 4.3.6 EUT OPERATING CONDITIONS

The software provided by client to enable the EUT under transmission condition continuously at lowest, middle and highest channel frequencies individually.



#### 4.3.7 TEST RESULTS

##### 802.11b

CHANNEL	FREQUENCY (MHz)	6dB BANDWIDTH (MHz)	MINIMUM LIMIT (MHz)	PASS / FAIL
1	2412	10.06	0.5	PASS
6	2437	10.07	0.5	PASS
11	2462	10.08	0.5	PASS

##### 802.11g

CHANNEL	FREQUENCY (MHz)	6dB BANDWIDTH (MHz)	MINIMUM LIMIT (MHz)	PASS / FAIL
1	2412	16.60	0.5	PASS
6	2437	16.61	0.5	PASS
11	2462	16.60	0.5	PASS

##### 802.11n (20MHz)

CHANNEL	FREQUENCY (MHz)	6dB BANDWIDTH (MHz)	MINIMUM LIMIT (MHz)	PASS / FAIL
1	2412	17.84	0.5	PASS
6	2437	17.84	0.5	PASS
11	2462	17.86	0.5	PASS

##### 802.11n (40MHz)

CHANNEL	FREQUENCY (MHz)	6dB BANDWIDTH (MHz)	MINIMUM LIMIT (MHz)	PASS / FAIL
3	2422	36.44	0.5	PASS
6	2437	36.39	0.5	PASS
9	2452	36.66	0.5	PASS



A D T

### SPECTRUM PLOT OF WORST VALUE

#### 802.11b

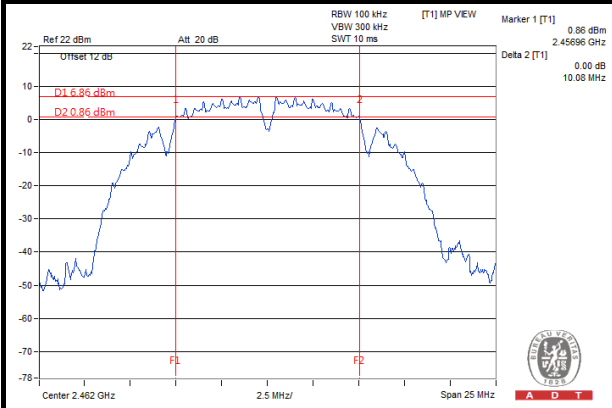

#### 802.11g

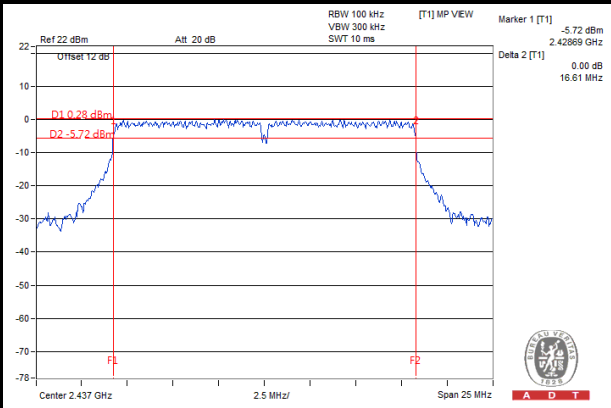

#### 802.11n (20MHz)

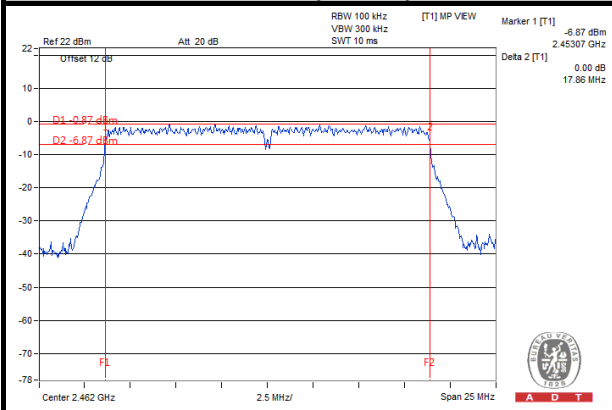

#### 802.11n (40MHz)

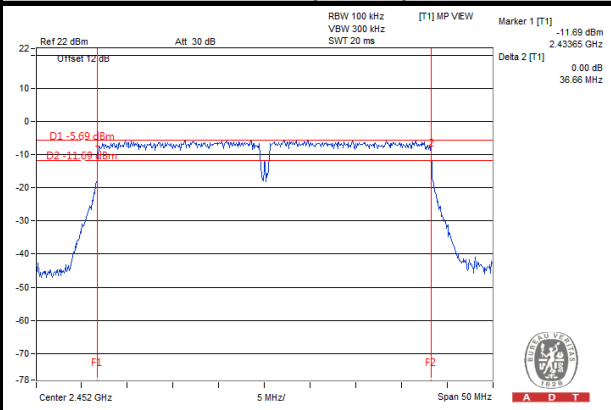

## 4.4 CONDUCTED OUTPUT POWER

### 4.4.1 LIMITS OF CONDUCTED OUTPUT POWER MEASUREMENT

For systems using digital modulation in the 2400–2483.5 MHz bands: 1 Watt (30dBm)

### 4.4.2 TEST SETUP

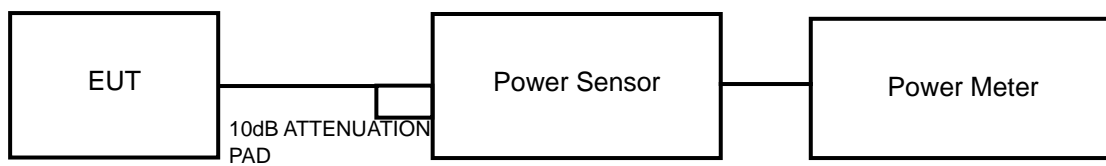

### 4.4.3 TEST INSTRUMENTS

Refer to section 4.1.2 to get information of above instrument.

### 4.4.4 TEST PROCEDURES

A peak power sensor was used on the output port of the EUT. A power meter was used to read the response of the peak power sensor. Record the peak power level.

### 4.4.5 DEVIATION FROM TEST STANDARD

No deviation.

### 4.4.6 EUT OPERATING CONDITIONS

Same as section 4.3.6.



A D T

#### 4.4.7 TEST RESULTS

##### 802.11b

CHANNEL	FREQUENCY (MHz)	PEAK POWER (mW)	PEAK POWER (dBm)	LIMIT (dBm)	PASS / FAIL
1	2412	65.16	18.14	30	PASS
6	2437	90.99	19.59	30	PASS
11	2462	77.80	18.91	30	PASS

##### 802.11g

CHANNEL	FREQUENCY (MHz)	PEAK POWER (mW)	PEAK POWER (dBm)	LIMIT (dBm)	PASS / FAIL
1	2412	156.68	21.95	30	PASS
6	2437	154.53	21.89	30	PASS
11	2462	160.69	22.06	30	PASS

##### 802.11n (20MHz)

CHANNEL	FREQUENCY (MHz)	PEAK POWER (mW)	PEAK POWER (dBm)	LIMIT (dBm)	PASS / FAIL
1	2412	123.88	20.93	30	PASS
6	2437	127.35	21.05	30	PASS
11	2462	130.02	21.14	30	PASS

##### 802.11n (40MHz)

CHANNEL	FREQUENCY (MHz)	PEAK POWER (mW)	PEAK POWER (dBm)	LIMIT (dBm)	PASS / FAIL
3	2422	116.95	20.68	30	PASS
6	2437	119.40	20.77	30	PASS
9	2452	121.90	20.86	30	PASS



## 4.5 POWER SPECTRAL DENSITY MEASUREMENT

### 4.5.1 LIMITS OF POWER SPECTRAL DENSITY MEASUREMENT

The Maximum of Power Spectral Density Measurement is 8dBm.

### 4.5.2 TEST SETUP

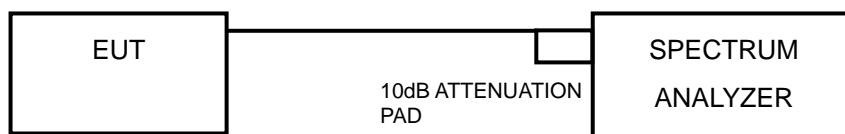

### 4.5.3 TEST INSTRUMENTS

Refer to section 4.1.2 to get information of above instrument.

### 4.5.4 TEST PROCEDURE

- Set the RBW = 3 kHz, VBW =10 kHz, Detector = peak.
- Sweep time = auto couple, Trace mode = max hold, allow trace to fully stabilize.
- Use the peak marker function to determine the maximum power level in any 100 kHz band segment within the fundamental EBW.

### 4.5.5 DEVIATION FROM TEST STANDARD

No deviation.

### 4.5.6 EUT OPERATING CONDITION

Same as section 4.3.6.



#### 4.5.7 TEST RESULTS

##### 802.11b

CHANNEL	FREQUENCY (MHz)	PSD (dBm/3kHz)	LIMIT (dBm/3kHz)	PASS / FAIL
1	2412	-11.43	8	PASS
6	2437	-11.35	8	PASS
11	2462	-11.29	8	PASS

##### 802.11g

CHANNEL	FREQUENCY (MHz)	PSD (dBm/3kHz)	LIMIT (dBm/3kHz)	PASS / FAIL
1	2412	-11.07	8	PASS
6	2437	-9.94	8	PASS
11	2462	-11.22	8	PASS

##### 802.11n (20MHz)

CHANNEL	FREQUENCY (MHz)	PSD (dBm/3kHz)	LIMIT (dBm/3kHz)	PASS / FAIL
1	2412	-10.69	8	PASS
6	2437	-10.41	8	PASS
11	2462	-10.55	8	PASS

##### 802.11n (40MHz)

CHANNEL	FREQUENCY (MHz)	PSD (dBm/3kHz)	LIMIT (dBm/3kHz)	PASS / FAIL
3	2422	-16.69	8	PASS
6	2437	-16.84	8	PASS
9	2452	-16.69	8	PASS



A D T

### SPECTRUM PLOT OF WORST VALUE

#### 802.11b

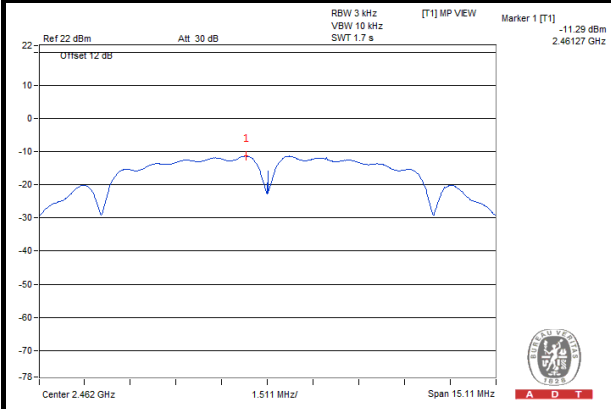

#### 802.11g

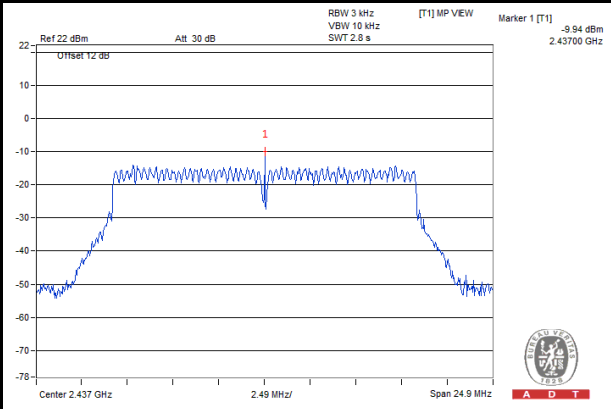

#### 802.11n (20MHz)

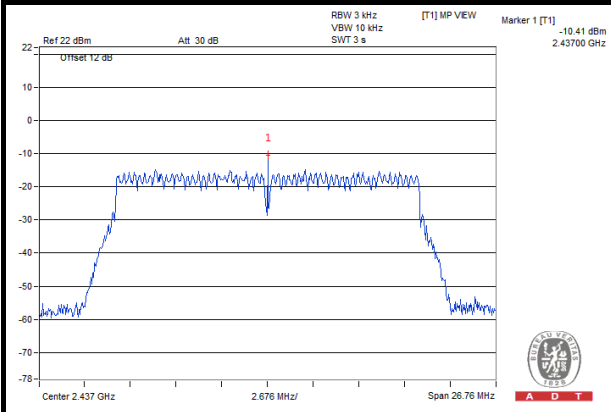

#### 802.11n (40MHz)

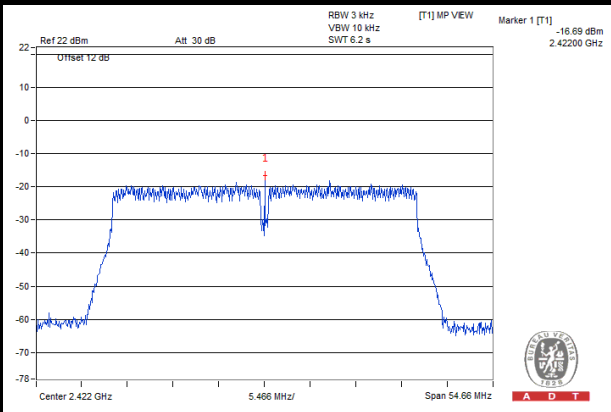

## 4.6 CONDUCTED OUT OF BAND EMISSION MEASUREMENT

### 4.6.1 LIMITS OF CONDUCTED OUT OF BAND EMISSION MEASUREMENT

Below  $-20\text{dB}$  of the highest emission level of operating band (in 100kHz Resolution Bandwidth).

### 4.6.2 TEST SETUP

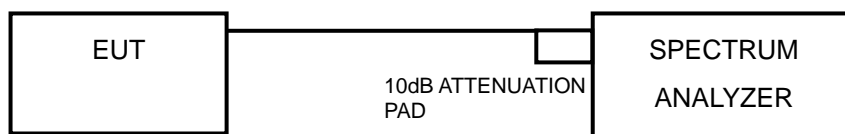

### 4.6.3 TEST INSTRUMENTS

Refer to section 4.1.2 to get information of above instrument.

### 4.6.4 TEST PROCEDURE

#### MEASUREMENT PROCEDURE REF

1. Set the RBW = 100 kHz.
2. Set the VBW  $\geq$  300 kHz.
3. Detector = peak.
4. Sweep time = auto couple.
5. Trace mode = max hold.
6. Allow trace to fully stabilize.
7. Use the peak marker function to determine the maximum power level in any 100 kHz band segment within the fundamental EBW.

#### MEASUREMENT PROCEDURE OOB

1. Set RBW = 100 kHz.
2. Set VBW  $\geq$  300 kHz.
3. Detector = peak.
4. Sweep = auto couple.
5. Trace Mode = max hold.
6. Allow trace to fully stabilize.
7. Use the peak marker function to determine the maximum amplitude level.

### 4.6.5 DEVIATION FROM TEST STANDARD

No deviation.

### 4.6.6 EUT OPERATING CONDITION

Same as section 4.3.6.



A D T

### 4.6.7 TEST RESULTS

The spectrum plots are attached on the following images. D1 line indicates the highest level, and D2 line indicates the 20dB offset below D1. It shows compliance with the requirement.

#### 802.11b

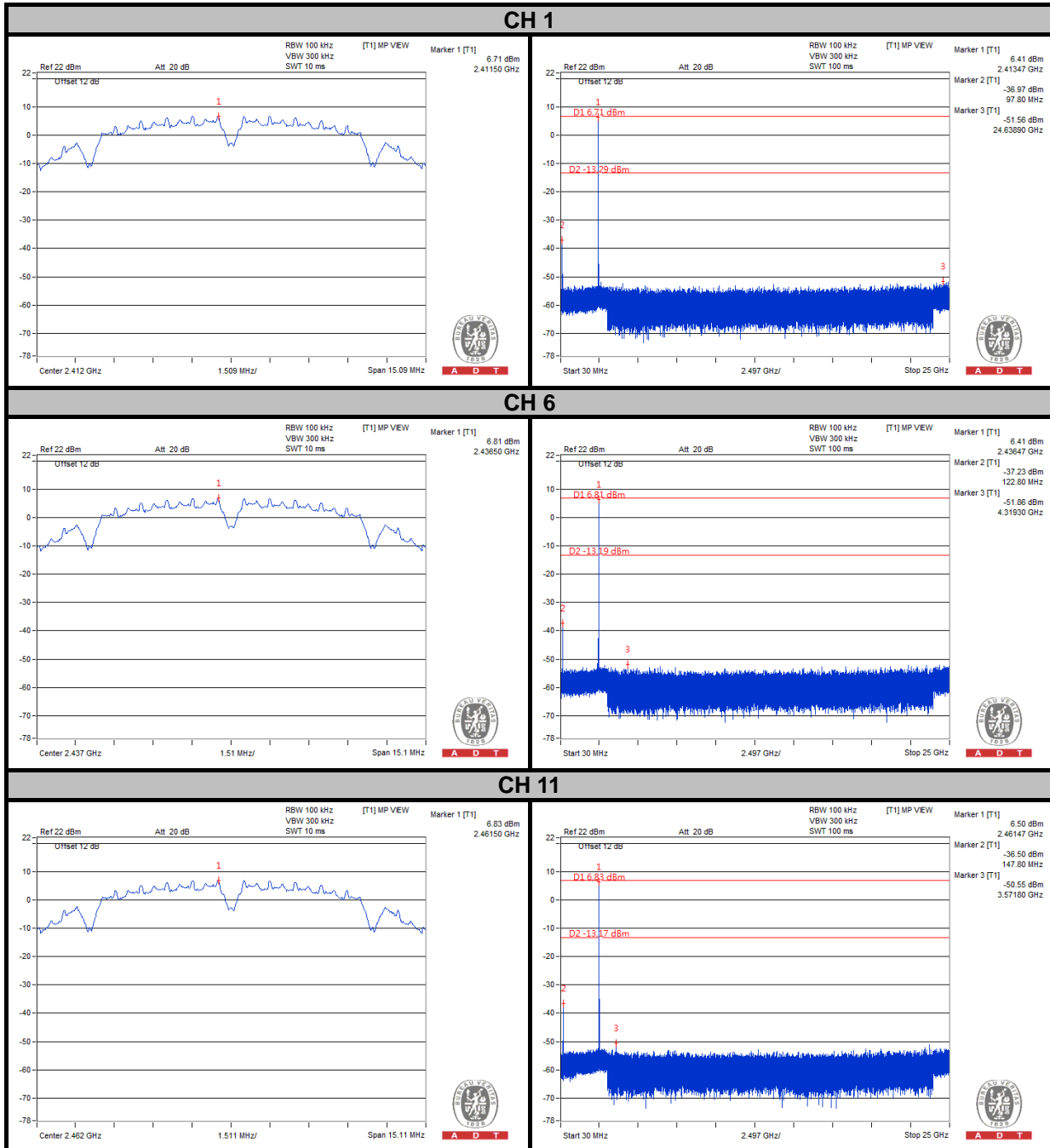



A D T

### 802.11g

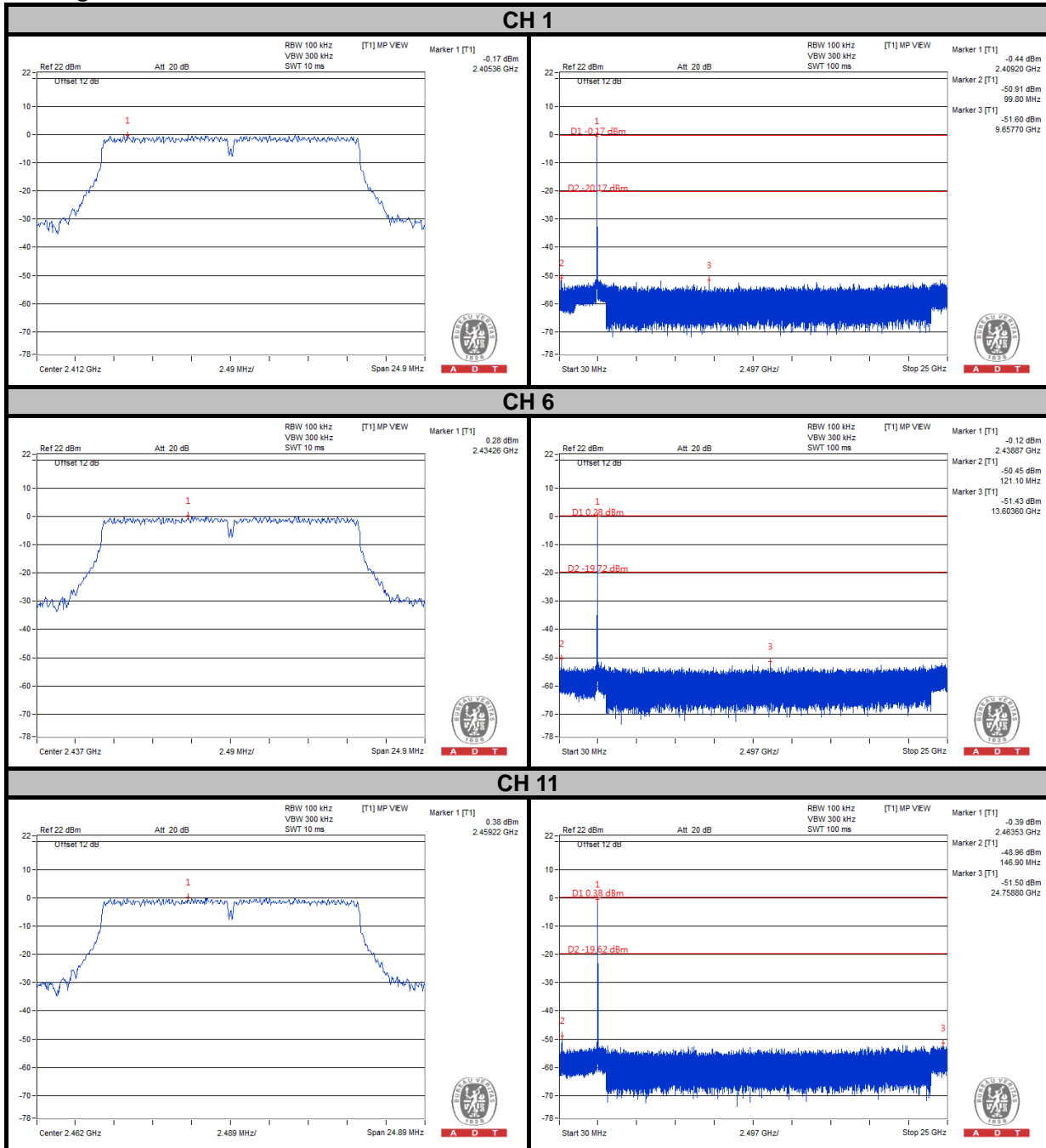



A D T

### 802.11n (20MHz)

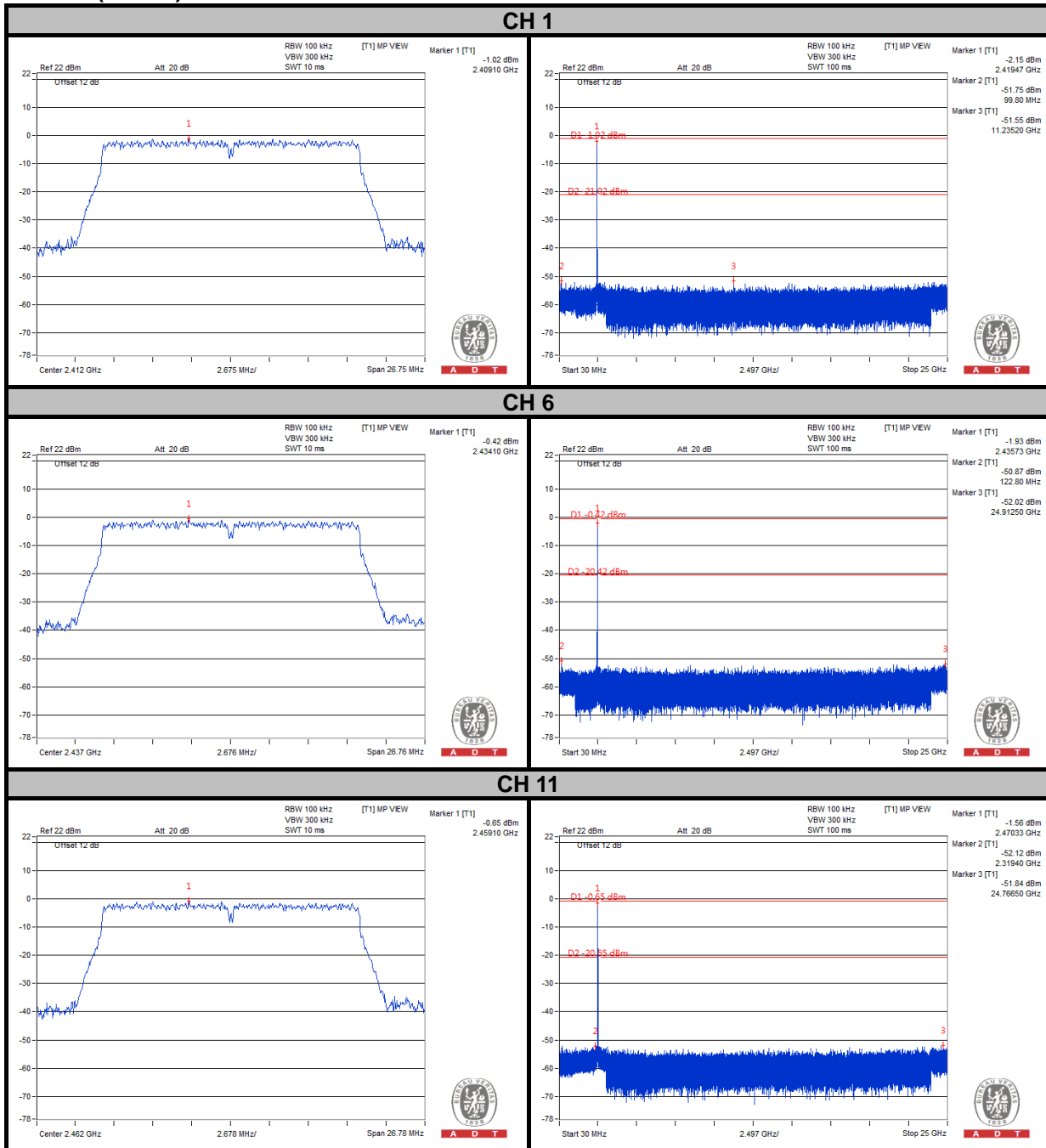



A D T

### 802.11n (40MHz)

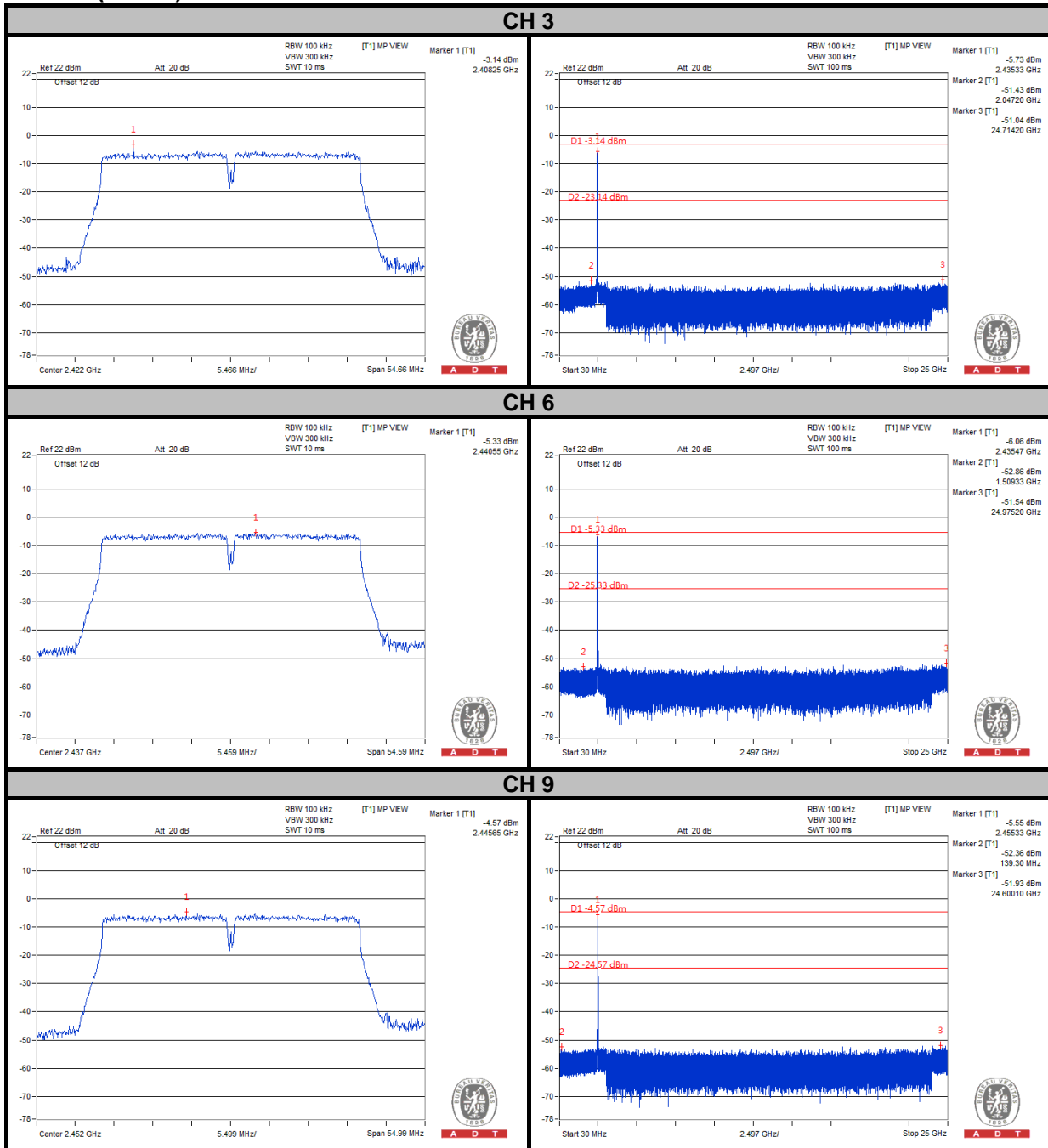





A D T

## 5. PHOTOGRAPHS OF THE TEST CONFIGURATION

Please refer to the attached file (Test Setup Photo).



## 6. INFORMATION ON THE TESTING LABORATORIES

We, Bureau Veritas Consumer Products Services (H.K.) Ltd., Taoyuan Branch, were founded in 1988 to provide our best service in EMC, Radio, Telecom and Safety consultation. Our laboratories are accredited and approved according to ISO/IEC 17025.

If you have any comments, please feel free to contact us at the following:

**Linko EMC/RF Lab:**

Tel: 886-2-26052180

Fax: 886-2-26051924

**Hsin Chu EMC/RF Lab:**

Tel: 886-3-5935343

Fax: 886-3-5935342

**Hwa Ya EMC/RF/Safety Telecom Lab:**

Tel: 886-3-3183232

Fax: 886-3-3270892

**Email:** [service.adt@tw.bureauveritas.com](mailto:service.adt@tw.bureauveritas.com)

**Web Site:** [www.bureauveritas-adt.com](http://www.bureauveritas-adt.com)

The address and road map of all our labs can be found in our web site also.



A D T

## **7. APPENDIX A – MODIFICATIONS RECORDERS FOR ENGINEERING CHANGES TO THE EUT BY THE LAB**

No any modifications are made to the EUT by the lab during the test.

---END---