

**FCC 47 CFR PART 15 SUBPART C: 2014 AND ANSI C63.10: 2013
TEST REPORT****For****LINX****Model: 1.0****Brand Name:**

Issued for

**ARB Corporation Ltd.
42-44 Garden St. Kilsyth, Victoria, Australia, 3137**

Issued By

Compliance Certification Services Inc.**Tainan Laboratory****No.8, Jiucengling, Xinhua Dist., Tainan City
712, Taiwan (R.O.C.)**

TEL: 886-6-580-2201

FAX: 886-6-580-2202

<http://www.ccsrf.com>**E-Mail : service@ccsrf.com****Issued Date: April 28, 2017**

Note: *This report shall not be reproduced except in full, without the written approval of Compliance Certification Services Inc. This document may be altered or revised by Compliance Certification Services Inc. personnel only, and shall be noted in the revision section of the document. The client should not use it to claim product endorsement by TAF or any government agencies. The test results in the report only apply to the tested sample.*

Attention is drawn to the limitation of liability, indemnification and jurisdiction issues defined therein. Any holder of this document is advised that information contained hereon reflects the Company's findings at the time of its intervention only and within the limits of Client's instructions, if any. The Company's sole responsibility is to its Client and this document does not exonerate parties to a transaction from exercising all their rights and obligations under the transaction documents. This document cannot be reproduced except in full, without prior written approval of the Company. Any unauthorized alteration, forgery or falsification of the content or appearance of this document is unlawful and offenders may be prosecuted to the fullest extent of the law.



REVISION HISTORY

Rev.	Issue Date	Revisions	Effect Page	Revised By
00	April 28, 2017	Initial Issue	ALL	Sunny Chang

TABLE OF CONTENTS

TITLE	PAGE NO.
1. TEST REPORT CERTIFICATION	4
2. EUT DESCRIPTION	5
2.1 DESCRIPTION OF EUT & POWER	5
3. DESCRIPTION OF TEST MODES	6
4. TEST METHODOLOGY	7
5. FACILITIES AND ACCREDITATIONS.....	8
5.1 FACILITIES	8
5.2 EQUIPMENT	8
5.3 LABORATORY ACCREDITATIONS LISTINGS	8
5.4 TABLE OF ACCREDITATIONS AND LISTINGS	9
6. SETUP OF EQUIPMENT UNDER TEST	10
6.2 SUPPORT EQUIPMENT	11
7. APPLICABLE LIMITS AND TEST RESULTS.....	14
7.1 20DB BANDWIDTH FOR HOPPING	14
7.2 MAXIMUM PEAK OUTPUT POWER.....	18
7.3 HOPPING CHANNEL SEPARATION	22
7.4 NUMBER OF HOPPING FREQUENCY USED	26
7.5 DWELL TIME ON EACH CHANNEL.....	29
7.6 CONDUCTED SPURIOUS EMISSION.....	33
7.7 RADIATED EMISSIONS	38
7.7.1 TRANSMITTER RADIATED SUPURIOUS EMSSIONS	38
7.7.2 WORST-CASE RADIATED EMISSION BELOW 1 GHZ.....	42
7.7.3 TRANSMITTER RADIATED EMISSION ABOVE 1 GHZ	44
7.7.4 RESTRICTED BAND EDGES	47
7.8 POWERLINE CONDUCTED EMISSIONS.....	51
APPENDIX I PHOTOGRPHS OF TEST SETUP	55
APPENDIX II PHOTOGRAPHS OF EUT	A1

1. TEST REPORT CERTIFICATION

Applicant	: ARB Corporation Ltd.
Address	: 42-44 Garden St. Kilsyth, Victoria, Australia, 3137
Manufacturer	: Vision Automobile Electronics Industrial Co., Ltd.
Address	: No. 78, Gongye 3rd Rd., Technology Industrial Park, Tainan City 70955, Taiwan (R.O.C.)
Equipment Under Test	: LINX
Model Number	: 1.0
Brand Name	: 
Date of Test	: March 22, 2017 ~ April 18, 2017

APPLICABLE STANDARD	
STANDARD	TEST RESULT
FCC Part 15 Subpart C: 2014 AND ANSI C63.10: 2013	PASS

We hereby certify that:

The above equipment was tested by Compliance Certification Services Inc. The test data, data evaluation, test procedures, and equipment configurations shown in this report were made in accordance with the procedures given in **ANSI C63.10: 2013** and the energy emitted by the sample EUT tested as described in this report is in compliance with the requirements of FCC Rules Part 15.207, 15.209, 15.247.

The test results of this report relate only to the tested sample EUT identified in this report.

Approved by:

Reviewed by:

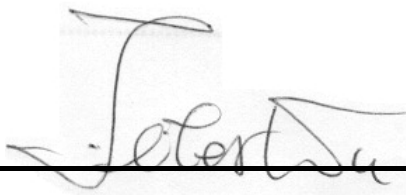

Jeter Wu
Assistant Manager

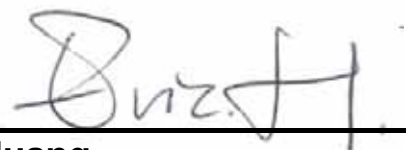

Eric Huang
Assistant Section Manager

2. EUT DESCRIPTION

2.1 DESCRIPTION OF EUT & POWER

Product	LINX
Model Number	1.0
Brand Name	
Identify Number	T170317N05
Received Date	March 17, 2017
Frequency Range	2402 ~ 2480 MHz
Transmit Peak Power	/4 DQPSK : -12.842dBm / 0.05197566mW
Channel Spacing	1MHz
Transmit Data Rate	$\pi/4$ DQPSK (2Mbps)
Modulation Technique	Frequency Hopping Spread Spectrum
Number of Channels	79 Channels
Power Supply	DC 12V
Antenna Type	Type: Chip-Antenna Manufacturer: Murata Model: LDA212G3110K Gain: 0.9dBi
Hardware Version	7450101 rev 1.0
Software Version	ARB LINX V 1.0.bin

Remark:

1. The sample selected for test was production product and was provided by manufacturer.
2. This submittal(s) (test report) is intended for **FCC ID: 2AA2H-LINX1** filing to comply with Section 15.207, 15.209 and 15.247 of the FCC Part 15, Subpart C Rules.
3. For more details, please refer to the User's manual of the EUT.

3. DESCRIPTION OF TEST MODES

The EUT had been tested under operating condition.

There are three channels have been tested as following :

Channel	Frequency (MHz)
Low	2402
Middle	2441
High	2480

Radiated Emission Test (Below 1 GHz):

- Pre-Scan has been conducted to determine the worst-case mode from all possible combinations between available modulations, data rates and antenna ports (if EUT with antenna diversity architecture).
- Following channel(s) was (were) selected for the final test as listed below.

Normal Operation

Radiated Emission Test (Above 1 GHz):

- Pre-Scan has been conducted to determine the worst-case mode from all possible combinations between available modulations, data rates and antenna ports (if EUT with antenna diversity architecture).
- Following channel(s) was (were) selected for the final test as listed below.

Tested Channel	Modulation Technology	Modulation Type	Mode
Low, Mid, High	FHSS	$\pi/4$ DQPSK	Normal

Bandedge Measurement:

- Pre-Scan has been conducted to determine the worst-case mode from all possible combinations between available modulations, data rates and antenna ports (if EUT with antenna diversity architecture).
- Following channel(s) was (were) selected for the final test as listed below.

Tested Channel	Modulation Technology	Modulation Type	Mode
Low, High	FHSS	$\pi/4$ DQPSK	Normal

Antenna Port Conducted Measurement:

- Pre-Scan has been conducted to determine the worst-case mode from all possible combinations between available modulations, data rates and antenna ports (if EUT with antenna diversity architecture).
- Following channel(s) was (were) selected for the final test as listed below.

Tested Channel	Modulation Technology	Modulation Type	Mode
Low, Mid, High	FHSS	$\pi/4$ DQPSK	Normal

Note :

The field strength of spurious emission was measured in the following position:

EUT have three test modes(X, Y, Z axis). The worst emission was found in X axis and the worst case was recorded.

4. TEST METHODOLOGY

The tests documented in this report were performed in accordance with ANSI C63.10 : 2013 and FCC CFR 47 15.207, 15.209 and 15.247.

5. FACILITIES AND ACCREDITATIONS

5.1 FACILITIES

All measurement facilities used to collect the measurement data are located at

No.8, Jiucengling, Xinhua Dist., Tainan City 712, Taiwan (R.O.C.)

The sites are constructed in conformance with the requirements of ANSI C63.7, ANSI C63.10 and CISPR Publication 22.

5.2 EQUIPMENT

Radiated emissions are measured with one or more of the following types of linearly polarized antennas: tuned dipole, bi-conical, log periodic, bi-log, and/or ridged waveguide, horn. Spectrum analyzers with pre-selectors and quasi-peak detectors are used to perform radiated measurements.

Conducted emissions are measured with Line Impedance Stabilization Networks and EMI Test Receivers.

Calibrated wideband preamplifiers, coaxial cables, and coaxial attenuators are also used for making measurements.

All receiving equipment conforms to CISPR Publication 16-1, "Radio Interference Measuring Apparatus and Measurement Methods."

5.3 LABORATORY ACCREDITATIONS LISTINGS

The test facilities used to perform radiated and conducted emissions tests are accredited by Taiwan Accreditation Foundation for the specific scope of accreditation under Lab Code: 1109 to perform Electromagnetic Interference tests according to FCC PART 15 AND CISPR 22 requirements. No part of this report may be used to claim or imply product endorsement by TAF or any agency of the Government. In addition, the test facilities are listed with Federal Communications Commission (registration no: TW-1037).

5.4 TABLE OF ACCREDITATIONS AND LISTINGS

Our laboratories are accredited and approved by the following approval agencies according to ISO/IEC 17025.

Taiwan	TAF
---------------	-----

The measuring facility of laboratories has been authorized or registered by the following approval agencies.

Canada	INDUSTRY CANADA
Germany	TUV NORD
Taiwan	BSMI
USA	FCC

Copies of granted accreditation certificates are available for downloading from our web site, <http://www.ccsrf.com>

6. SETUP OF EQUIPMENT UNDER TEST

For RF test:

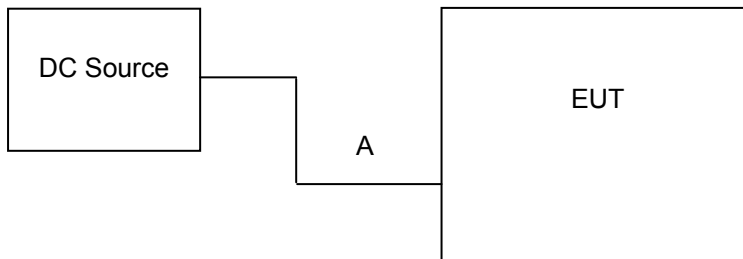

For EMI test :

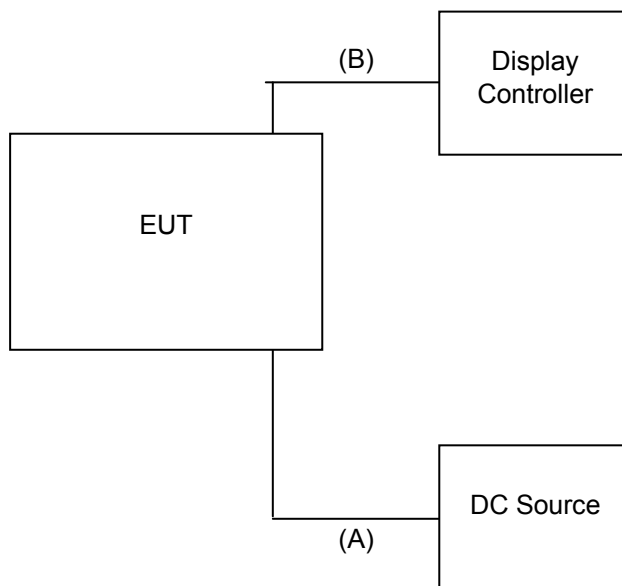

6.2 SUPPORT EQUIPMENT

For RF test

No.	Product	Manufacturer	Model No.	Certify No.	Signal cable
1	DC Power Supply	GW	GPR-3036D	DOC	Power cable, unshd, 1.6m

No.	Signal cable description	
A	Power	Unshielded, 1.2m, 1pcs.

For EMI test

No.	Product	Manufacturer	Model No.	Certify No.	Signal cable
1	Display Controller	Fly	ARB GUVI	DOC	N/A

No.	Signal cable description	
A	DC Power	Unshielded, 1.8m, 1 pcs
B	USB Cable	Shielded, 2.0m, 1pcs.

*shd=shielded, unshd=unshielded

EUT OPERATING CONDITION

RF Setup

1. Set up a whole system as the setup diagram.
- 2.

TX Mode

To test on channel 0

Use the jumper between the first 2 pins from the left in section I.



To test on channel 39

Use the jumper between the first 2 pins from the left in section J.

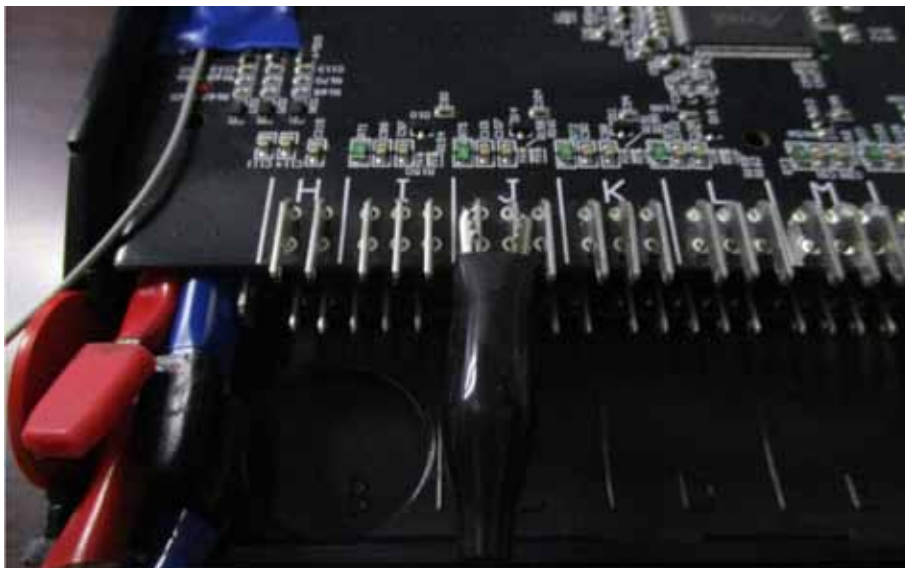

To test on channel 78

Use the jumper between the first 2 pins from the left in section K.



RX Mode

Not jumper any pins.

3. Turn ON the power , and start test.

7. APPLICABLE LIMITS AND TEST RESULTS

7.1 20dB BANDWIDTH FOR HOPPING

LIMIT

None; for reporting purposes only.

TEST EQUIPMENT

Name of Equipment	Manufacturer	Model	Serial Number	Calibration Due
EXA Spectrum Analyzer	KEYSIGHT	N9010A	MY54430216	04/29/2017

TEST SETUP

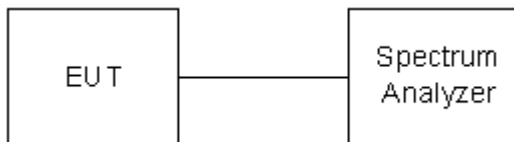

TEST PROCEDURE

The 20dB band width was measured with a spectrum analyzer connected to RF antenna connector (conducted measurement) while EUT was operating in transmit mode at the appropriate center frequency. The analyzer center frequency was set to the EUT carrier frequency, using the analyzer. Display Line and Marker Delta functions, the 20dB band width of the emission was determined.



TEST RESULTS

Modulation Type: $\pi/4$ DQPSK

Channel	Channel Frequency (MHz)	20dB Bandwidth (kHz)	Pass / Fail
Low	2402	819.00	N/A
Middle	2441	818.00	N/A
High	2480	817.00	N/A



20dB BANDWIDTH

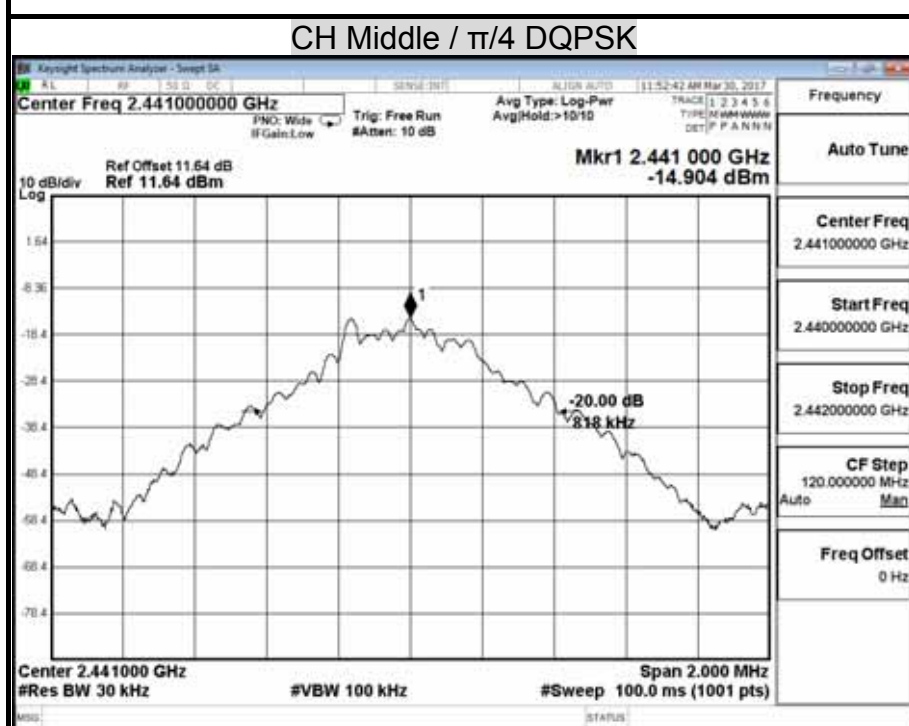
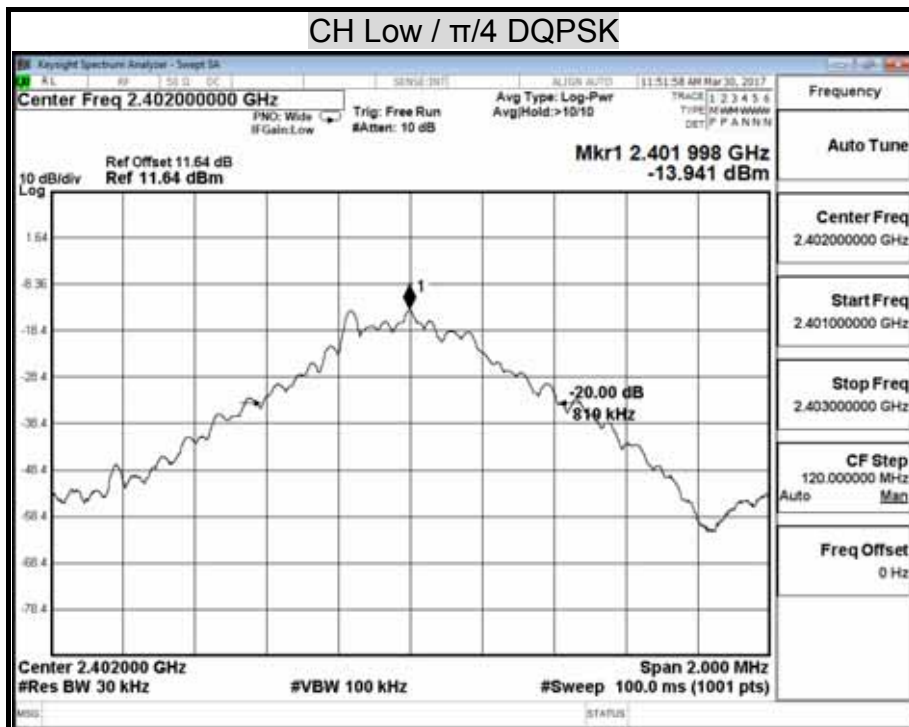

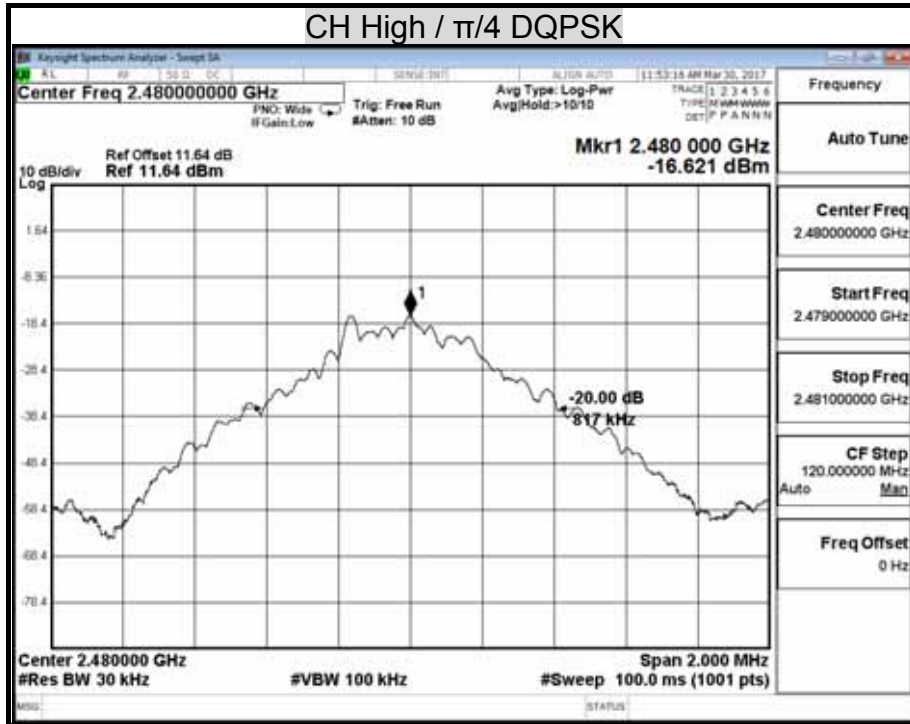

7.2 MAXIMUM PEAK OUTPUT POWER

LIMIT

§15.247(b)(1) For frequency hopping systems operating in the 2400-2483.5 MHz band employing at least 75 non-overlapping hopping channels, and all frequency hopping systems in the 5725-5850 MHz band: 1 watt. For all other frequency hopping systems in the 2400-2483.5 MHz band: 0.125 watts.

TEST EQUIPMENT

Name of Equipment	Manufacturer	Model	Serial Number	Calibration Due
EXA Spectrum Analyzer	KEYSIGHT	N9010A	MY54430216	04/29/2017

TEST SETUP



TEST PROCEDURE

The RF power output was measured with a Spectrum Analyzer connected to the RF Antenna connector (conducted measurement) while EUT was operating in transmit mode at the appropriate center frequency, A power meter was used to record the shape of the transmit signal.

Span = approximately 5 times the 20 dB bandwidth, centered on a hopping channel

RBW > the 20 dB bandwidth of the emission being measured

VBW ≥ RBW

Sweep = auto

Detector function = peak

Trace = max hold

TEST RESULTS

Modulation Type: $\pi/4$ DQPSK

Channel	Channel Frequency (MHz)	Peak Power Output (dBm)	Peak Power Output (mW)	Limit (mW)	Result
Low	2402	-12.84	0.05198	125	PASS
Mid	2441	-13.71	0.04256		PASS
High	2480	-15.41	0.02879		PASS



MAXIMUM PEAK OUTPUT POWER

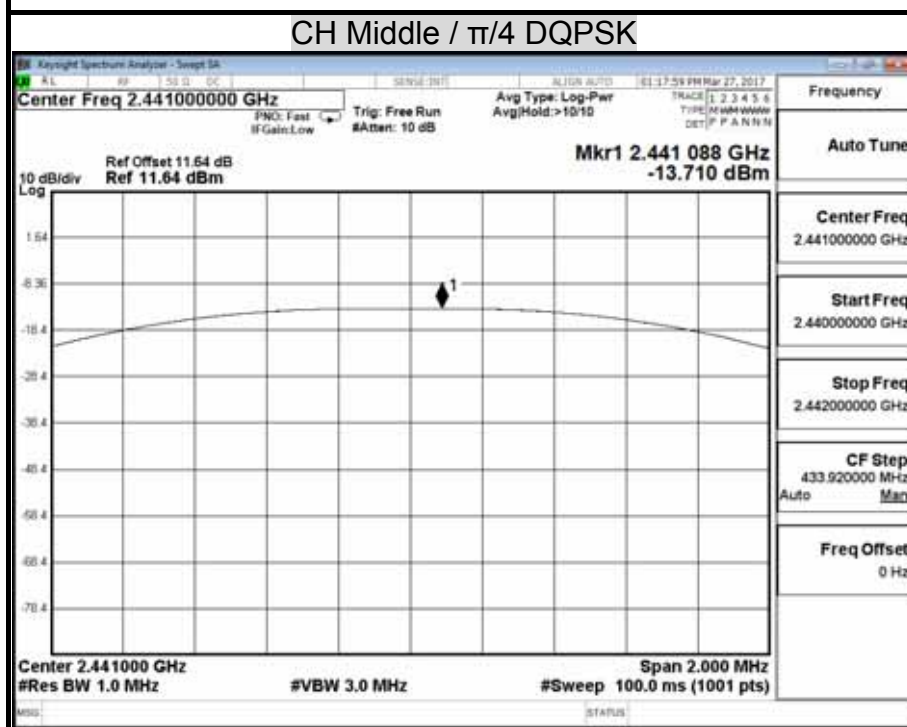
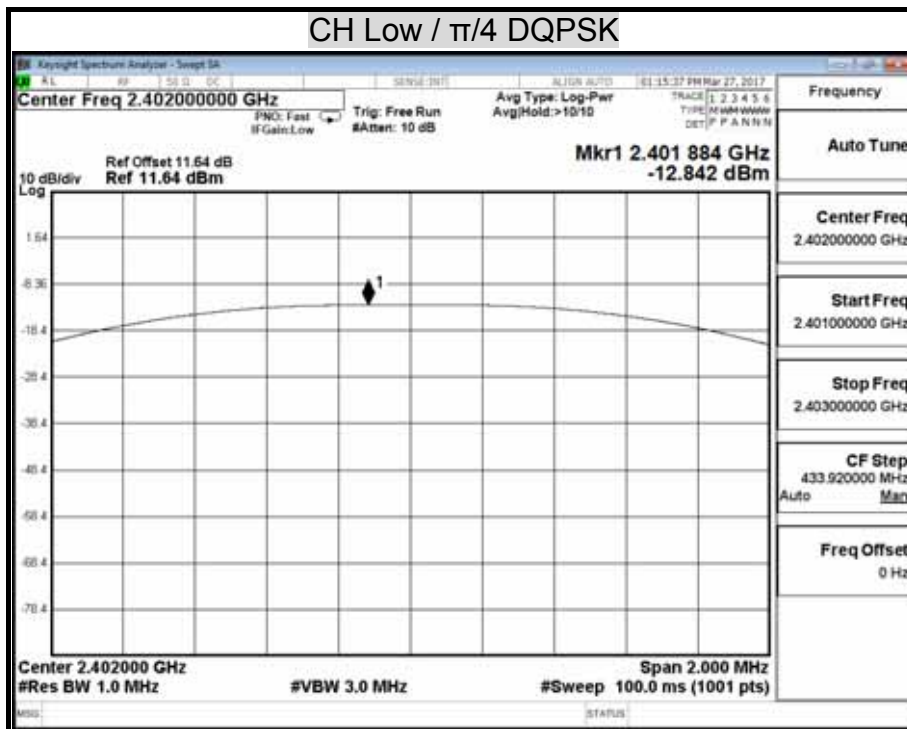

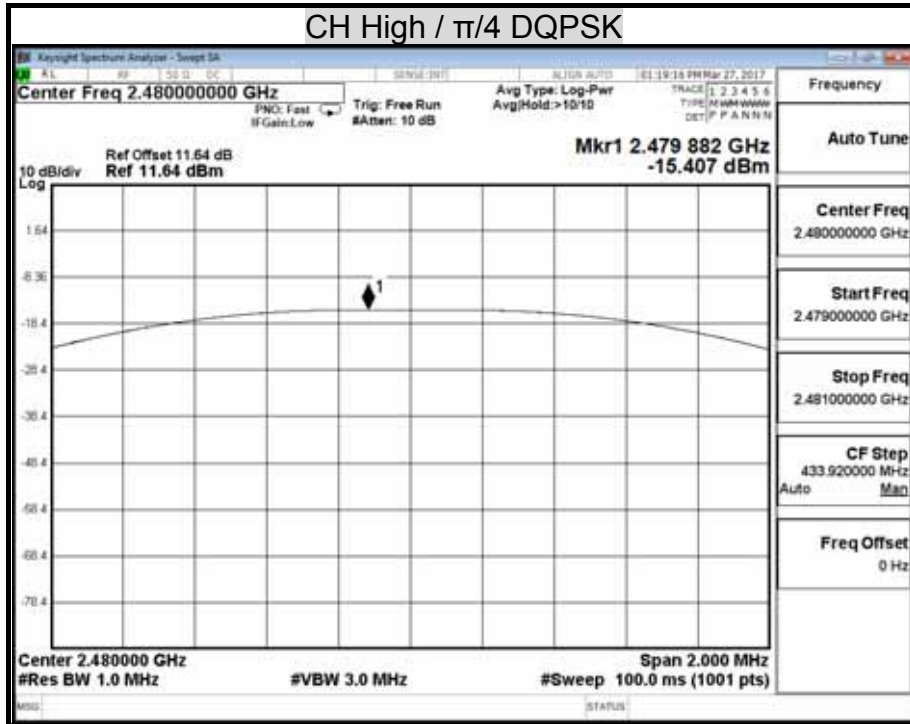

7.3 HOPPING CHANNEL SEPARATION

LIMIT

§15.247(a)(1) Frequency hopping systems shall have hopping channel carrier frequencies separated by a minimum of 25 kHz or the 20 dB bandwidth of the hopping channel, whichever is greater. Alternatively, frequency hopping systems operating in the 2400-2483.5 MHz band may have hopping channel carrier frequencies that are separated by 25 kHz or two-thirds of the 20 dB bandwidth of the hopping channel, whichever is greater, provided the systems operate with an output power no greater than 125 mW. The system shall hop to channel frequencies that are selected at the system hopping rate from a pseudo andomly ordered list of hopping frequencies. Each frequency must be used equally on the average by each transmitter. The system receivers shall have input bandwidths that match the hopping channel bandwidths of their corresponding transmitters and shall shift frequencies in synchronization with the transmitted signals.

TEST EQUIPMENT

Name of Equipment	Manufacturer	Model	Serial Number	Calibration Due
EXA Spectrum Analyzer	KEYSIGHT	N9010A	MY54430216	04/29/2017

TEST SETUP



TEST PROCEDURE

1. Check the calibration of the measuring instrument using either an internal calibrator or a known signal from an external generator.
2. Position the EUT as shown in test setup without connection to measurement instrument. Turn on the EUT and connect it to measurement instrument. Then set it to any one convenient frequency within its operating range.
3. By using the MaxHold function record the separation of adjacent channels.
4. Measure the frequency difference of these two adjacent channels by spectrum analyzer MARK function. And then plot the result on spectrum analyzer screen.
5. Repeat above procedures until all frequencies measured were complete.



TEST RESULTS

Refer to section 8.1, 20dB bandwidth measurement, the measured channel separation should be greater than two-third of 20dB bandwidth or Minimum bandwidth.

Modulation Type: $\pi/4$ DQPSK

Channel (MHz)	Adjacent Hopping Channel Separation (MHz)	Two -third of 20dB bandwidth (MHz)	Minimum Bandwidth (kHz)	Result
2402	1.00	0.55	25 KHz	PASS
2441	1.00	0.55	25 KHz	PASS
2480	1.00	0.54	25 KHz	PASS

HOPPING CHANNEL SEPARATION

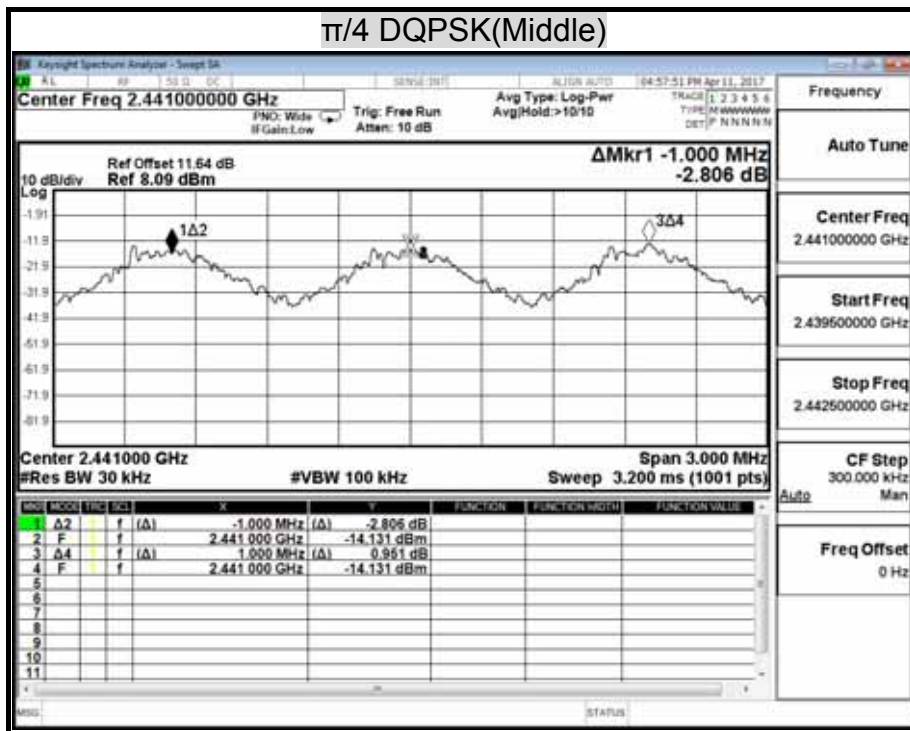
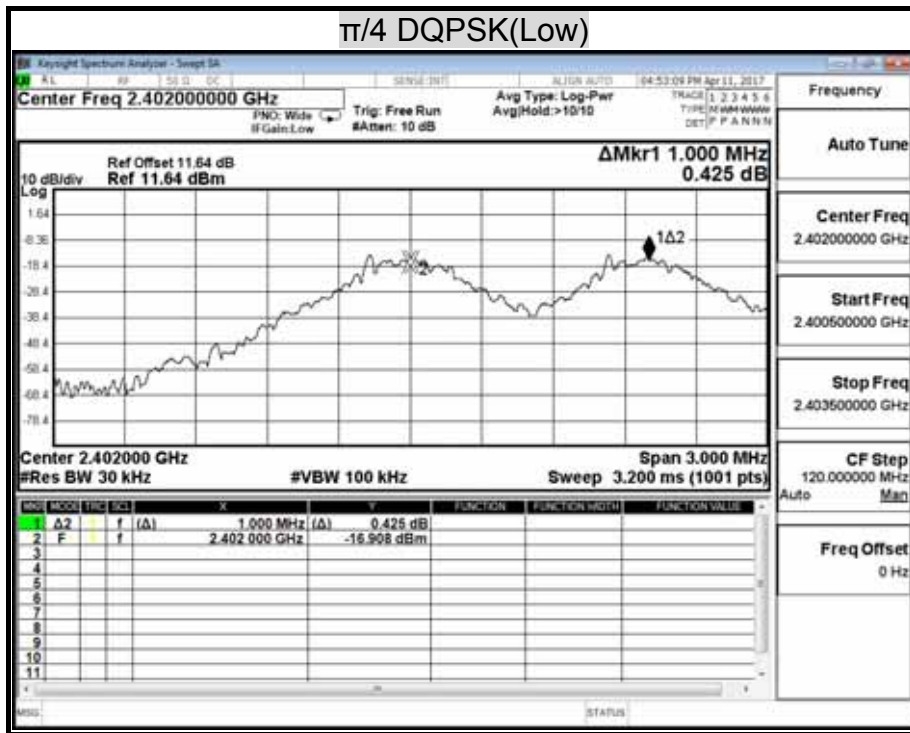

7.4 NUMBER OF HOPPING FREQUENCY USED

LIMIT

§15.247(a)(1)(iii) For frequency hopping systems in the 2400-2483.5 MHz band shall use at least 15 channels.

TEST EQUIPMENT

Name of Equipment	Manufacturer	Model	Serial Number	Calibration Due
EXA Spectrum Analyzer	KEYSIGHT	N9010A	MY54430216	04/29/2017

TEST SETUP



TEST PROCEDURE

- 1 Check the calibration of the measuring instrument (spectrum analyzer) using either an internal calibrator or a known signal from an external generator.
- 2 Position the EUT as shown in test setup without connection to measurement instrument. Turn on the EUT and connect its antenna terminal to measurement instrument via a low loss cable. Then set it to any one measured frequency within its operating range and make sure the instrument is operated in its linear range.
- 3 Set the spectrum analyzer on MaxHold Mode, and then keep the EUT in hopping mode. Record all the signals from each channel until each one has been recorded.
- 4 Set the spectrum analyzer on View mode and then plot the result on spectrum analyzer screen.
- 5 Repeat above procedures until all frequencies measured were complete.

TEST RESULTS

Modulation Type: $\pi/4$ DQPSK / Normal

Result(No.of CH)	Limit(No.of CH)	Result
79	>75	PASS



NUMBER OF HOPPING FREQUENCY USED

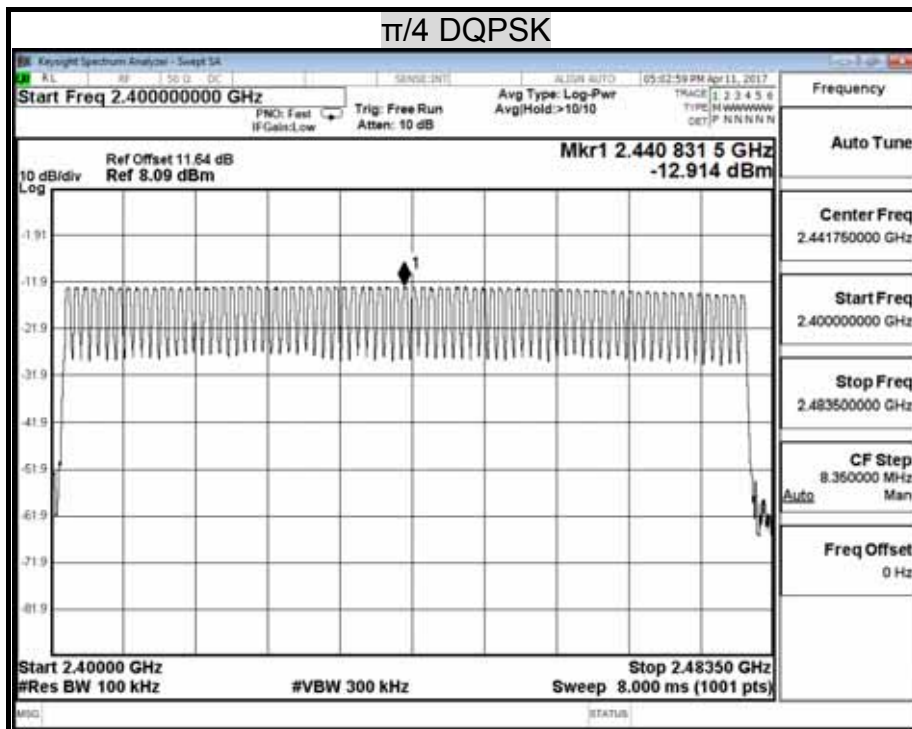

7.5 DWELL TIME ON EACH CHANNEL

LIMIT

§15.247(a)(1)(iii) For frequency hopping system operating in the 2400-2483.5MHz band, the average time of occupancy on any frequency shall not be greater than 0.4 second within a 31.6 second period.

TEST EQUIPMENT

Name of Equipment	Manufacturer	Model	Serial Number	Calibration Due
EXA Spectrum Analyzer	KEYSIGHT	N9010A	MY54430216	04/29/2017

TEST SETUP



TEST PROCEDURE

1. Check the calibration of the measuring instrument using either an internal calibrator or a known signal from an external generator.
2. Position the EUT as shown in test setup without connection to measurement instrument. Turn on the EUT and connect its antenna terminal to measurement instrument via a low loss cable. Then set it to any one measured frequency within its operating range and make sure the instrument is operated in its linear range.
3. Adjust the center frequency of spectrum analyzer on any frequency be measured and set spectrum analyzer to zero span mode. And then, set RBW and VBW of spectrum analyzer to proper value.
4. Measure the time duration of one transmission on the measured frequency. And then plot the result with time difference of this time duration.
5. Repeat above procedures until all frequencies measured were complete.
6. The Bluetooth Headset has 1 type of payload. The hopping rate is 1600 per second. The longer the payload is, the slower the hopping rate is.



TEST RESULTS

Time of occupancy on the TX channel in 31.6sec = time domain slot length × hop rate ÷ number of hop per channel × 31.6

Refer to the attached graph.

The hopping rates of Bluetooth devices change with different types of payload. The longer the payload is, the slower the hopping rate. The hopping rate scenario is defined in Bluetooth core specification.

Modulation Type: $\pi/4$ DQPSK

Transmitting Frequency	Mode	Dwell time (ms)	Time of occupancy on the TX channel in 31.6sec (ms)	Limit for Time of occupancy on the TX channel in 31.6sec (ms)	Results
2441MHz	Normal	2.960	315.73	400.00	PASS
2441MHz	AFH	2.960	157.87	400.00	PASS

Normal Dwell time= 2.960 ms×(1600÷6)÷79×31.6= 315.73 (ms)
 AFH Dwell time= 2.960 ms×(800÷6)÷20×8= 157.87 (ms)



DWELL TIME ON EACH PAYLOAD

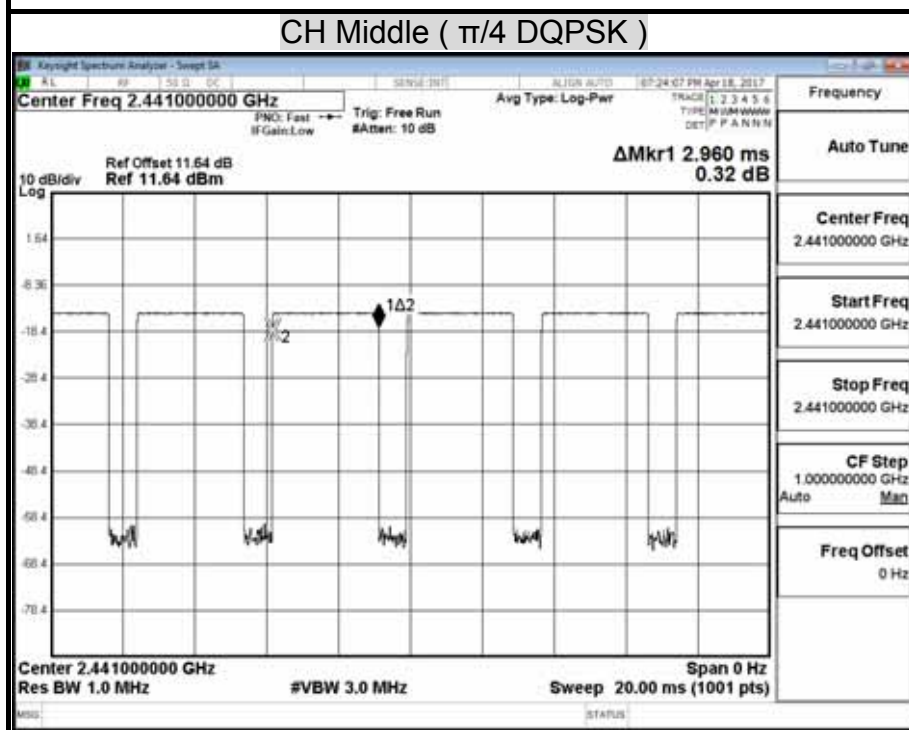
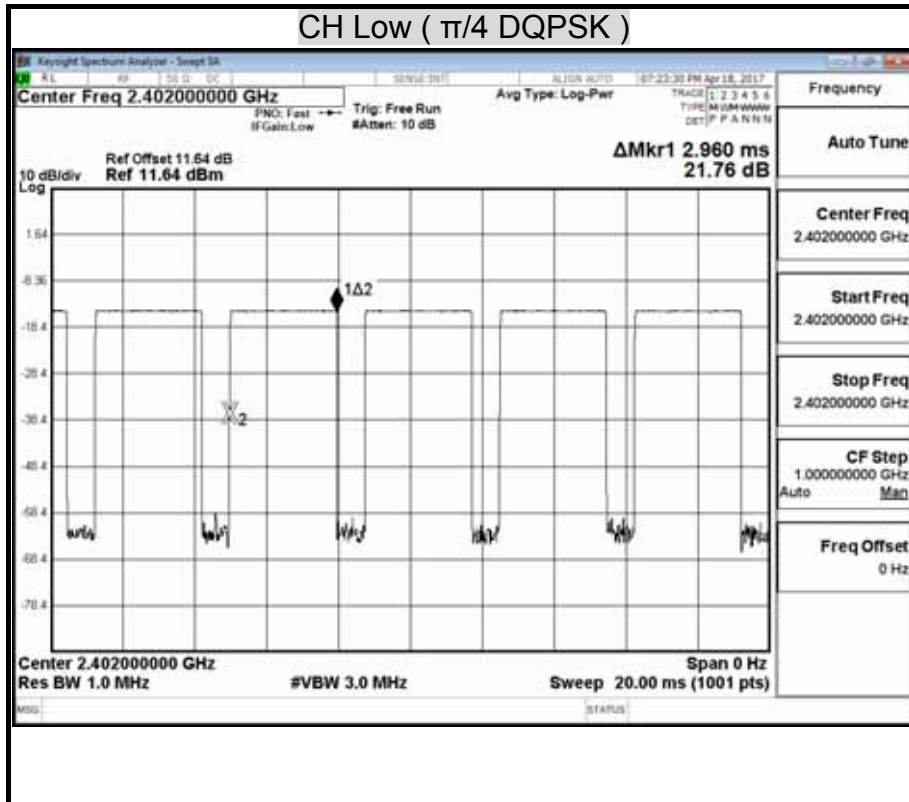

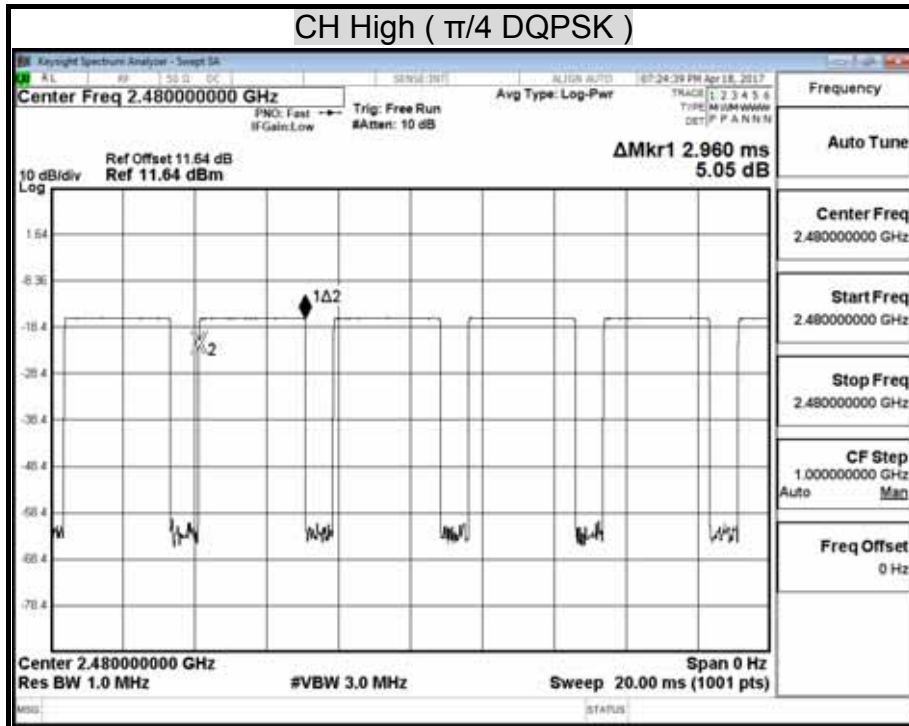

7.6 CONDUCTED SPURIOUS EMISSION

LIMITS

§ 15.247(d) In any 100 kHz bandwidth outside the frequency band in which the spread spectrum intentional radiator is operating, the radio frequency power that is produced by the intentional radiator shall be at least 20 dB below that in the 100 kHz bandwidth within the band that contains the highest level of the desired power, based on either an RF conducted or a radiated measurement. Attenuation below the general limits specified in § 15.209(a) is not required. In addition, radiated emissions which fall in the restricted bands, as defined in § 15.205(a), must also comply with the radiated emission limits specified in § 15.209(a) (see § 15.205(c)).

TEST EQUIPMENT

Name of Equipment	Manufacturer	Model	Serial Number	Calibration Due
EXA Spectrum Analyzer	KEYSIGHT	N9010A	MY54430216	04/29/2017

TEST SETUP



TEST PROCEDURE

The transmitter output is connected to a spectrum analyzer. The resolution bandwidth is set to 100 kHz. The video bandwidth is set to 300 kHz.

The spectrum from 30 MHz to 26.5 GHz is investigated with the transmitter set to the lowest, middle, and highest channels in the 2.4 GHz band.

TEST RESULTS

OUT-OF-BAND SPURIOUS EMISSIONS-CONDUCTED MEASUREMENT

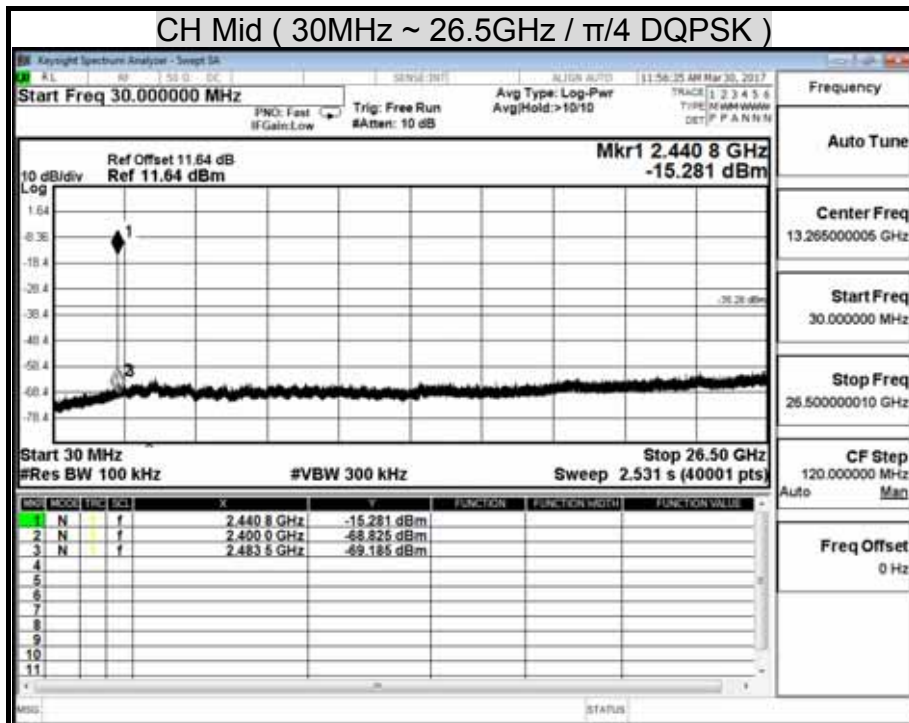
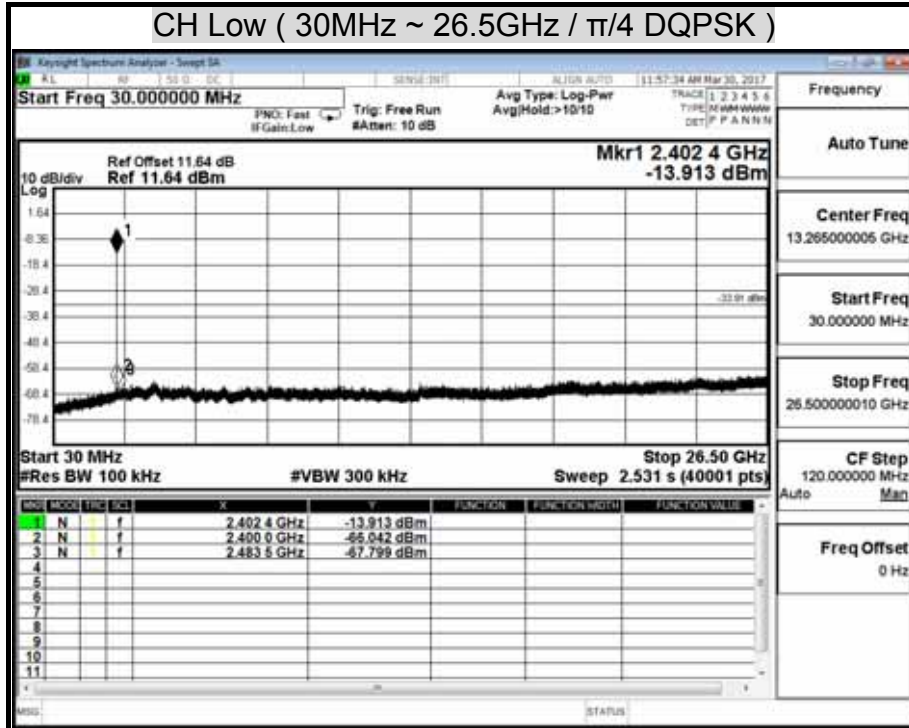

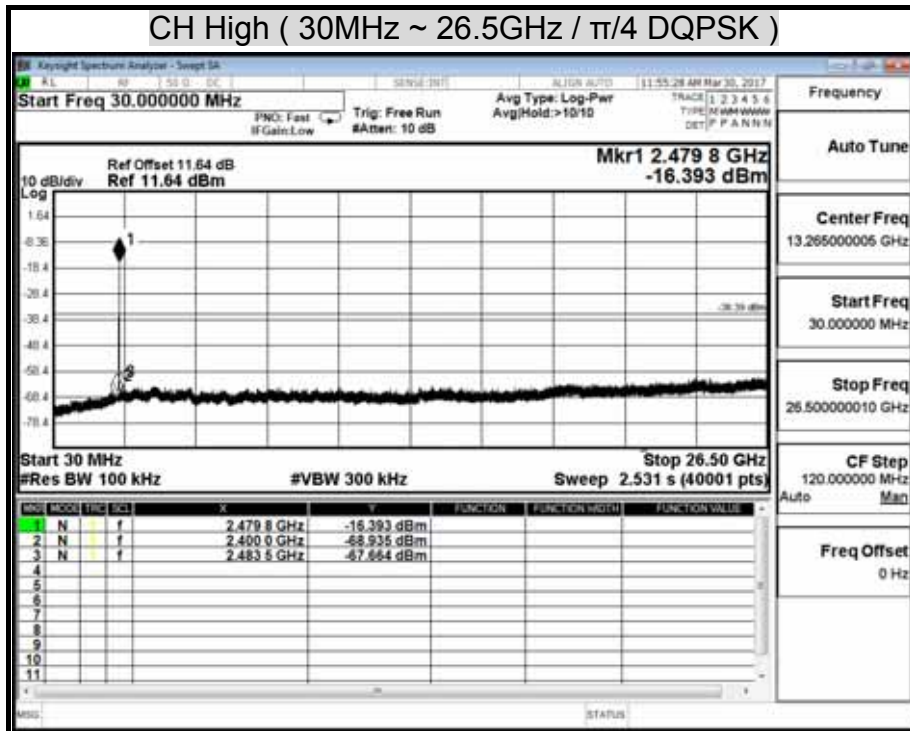

Band-edge Compliance of RF Conducted Emissions

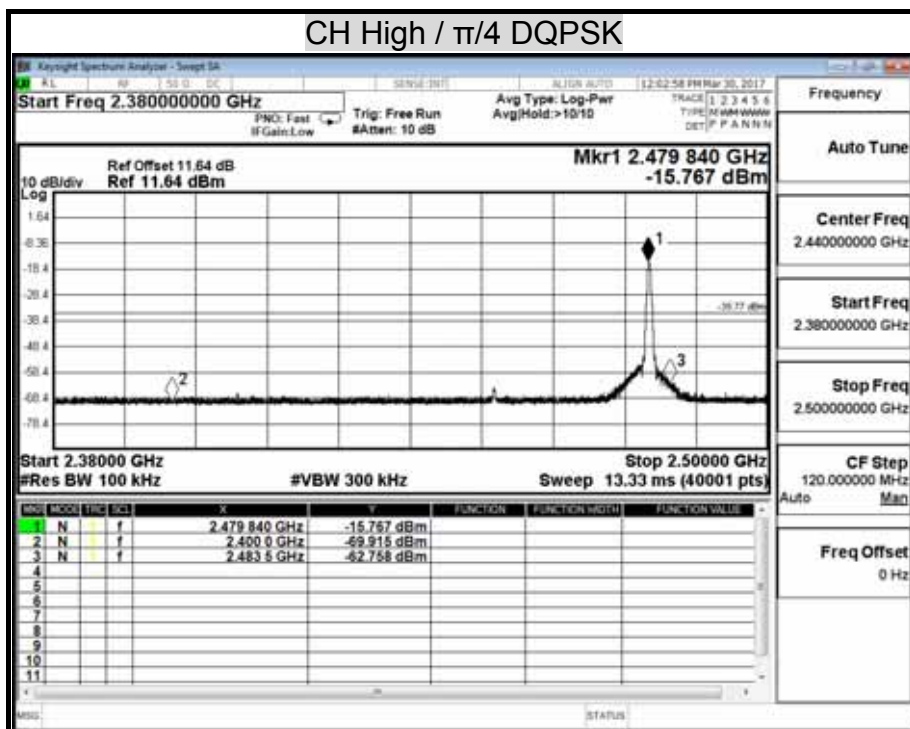
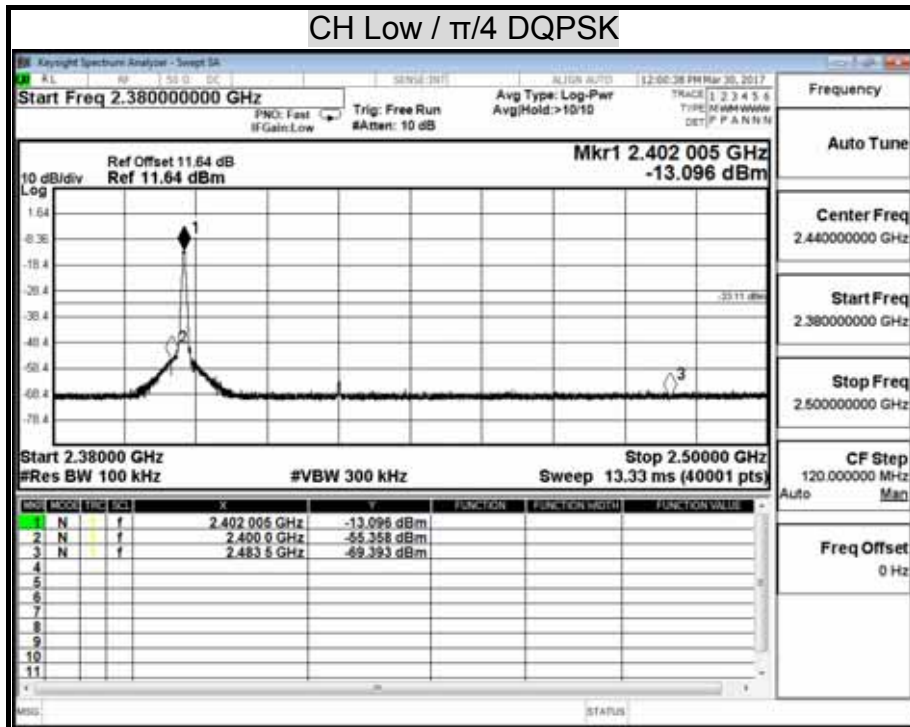

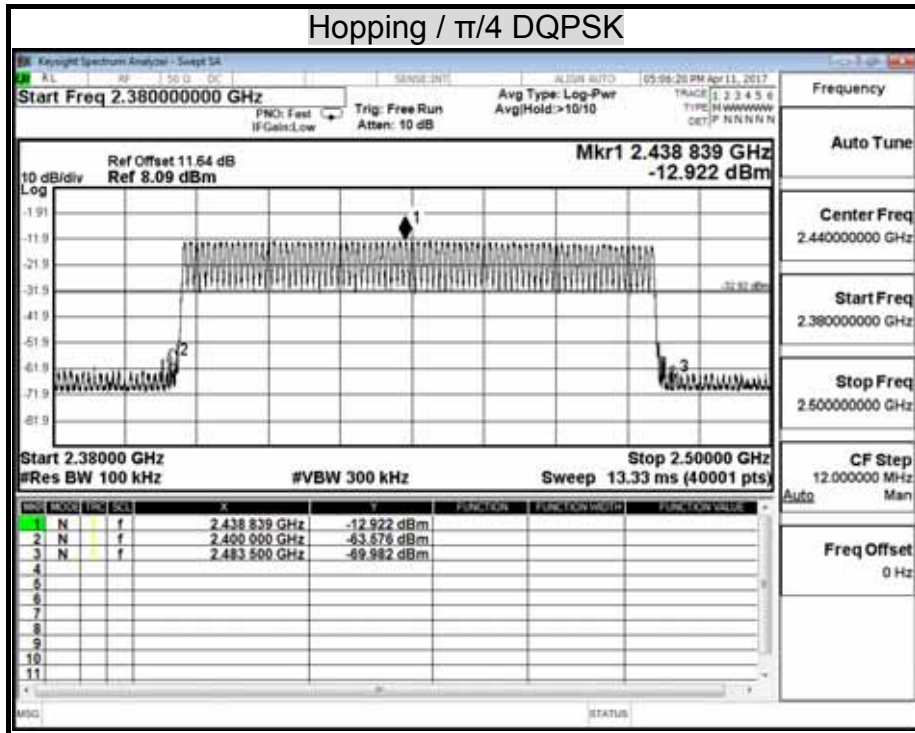



7.7 RADIATED EMISSIONS

7.7.1 TRANSMITTER RADIATED SUPURIOUS EMSSIONS

LIMITS

§ 15.205 (a) Except as shown in paragraph (d) of this section, only spurious emissions are permitted in any of the frequency bands listed below:

MHz	MHz	MHz	GHz
0.090 - 0.110	16.42 - 16.423	399.9 - 410	4.5 - 5.15
¹ 0.495 - 0.505	16.69475 - 16.69525	608 - 614	5.35 - 5.46
2.1735 - 2.1905	16.80425 - 16.80475	960 - 1240	7.25 - 7.75
4.125 - 4.128	25.5 - 25.67	1300 - 1427	8.025 - 8.5
4.17725 - 4.17775	37.5 - 38.25	1435 - 1626.5	9.0 - 9.2
4.20725 - 4.20775	73 - 74.6	1645.5 - 1646.5	9.3 - 9.5
6.215 - 6.218	74.8 - 75.2	1660 - 1710	10.6 - 12.7
6.26775 - 6.26825	108 - 121.94	1718.8 - 1722.2	13.25 - 13.4
6.31175 - 6.31225	123 - 138	2200 - 2300	14.47 - 14.5
8.291 - 8.294	149.9 - 150.05	2310 - 2390	15.35 - 16.2
8.362 - 8.366	156.52475 - 156.52525	2483.5 - 2500	17.7 - 21.4
8.37625 - 8.38675	156.7 - 156.9	2655 - 2900	22.01 - 23.12
8.41425 - 8.41475	162.0125 - 167.17	3260 - 3267	23.6 - 24.0
12.29 - 12.293	167.72 - 173.2	3332 - 3339	31.2 - 31.8
12.51975 - 12.52025	240 - 285	3345.8 - 3338	36.43 - 36.5
12.57675 - 12.57725	322 - 335.4	3600 - 4400	(²)
13.36 - 13.41			

¹ Until February 1, 1999, this restricted band shall be 0.490-0.510 MHz.

² Above 38.6

§ 15.205 (b) Except as provided in paragraphs (d) and (e), the field strength of emissions appearing within these frequency bands shall not exceed the limits shown in Section 15.209. At frequencies equal to or less than 1000 MHz, compliance with the limits in Section 15.209 shall be demonstrated using measurement instrumentation employing a CISPR quasi-peak detector. Above 1000 MHz, compliance with the emission limits in Section 15.209 shall be demonstrated based on the average value of the measured emissions. The provisions in Section 15.35 apply to these measurements.

§ 15.209 (a) Except as provided elsewhere in this Subpart, the emissions from an intentional radiator shall not exceed the field strength levels specified in the following table :

Frequency (MHz)	Field Strength (microvolts/meter)	Measurement Distance (meters)
30 - 88	100 **	3
88 - 216	150 **	3
216 - 960	200 **	3
Above 960	500	3

** Except as provided in paragraph (g), fundamental emissions from intentional radiators operating under this Section shall not be located in the frequency bands 54-72 MHz, 76-88 MHz, 174-216 MHz or 470-806 MHz, However, operation within these frequency bands is permitted under other sections of this Part, e-g, Sections 15.231 and 15.241.

§ 15.209 (b) In the emission table above, the tighter limit applies at the band edges.

TEST EQUIPMENT

Open Area Test Site # 5 (Below 1GHz)				
Name of Equipment	Manufacturer	Model	Serial Number	Calibration Due
Bi-Log Antenna	Sunol	JB1	A070506-1	07/22/2017
EMI Test Receiver	R&S	ESCI 7	100856	11/27/2017
Loop Antenna	COM-POWER	AL-130	121060	05/23/2017
Type N coaxial cable	Suhner	RG_214_U/2X	5	01/16/2018
Software	e3 (5.04211j)			

Chamber Room # 966 (Above 1GHz)				
Name of Equipment	Manufacturer	Model	Serial Number	Calibration Due
Amplifier	HP	8447F	2443A01671	01/17/2018
Bi-Log Antenna	Sunol	JB1	A070506-2	07/22/2017
Cable	HUBER+SUHNER	SUCOFLEX 104PEA	SN25737 /4PEA	01/17/2018
EMI Test Receiver	R&S	ESCS 30	100294	12/01/2017
EXA Spectrum Analyzer	KEYSIGHT	N9010A	MY54430216	04/29/2017
Horn Antenna	Com-Power	AH-118	071032	02/08/2018
Pre-Amplifier	EMCI	EMC012645	980098	01/16/2018

Remark: 1. Each piece of equipment is scheduled for calibration once a year.

2. N.C.R = No Calibration Required

TEST SETUP

The diagram below shows the test setup that is utilized to make the measurements for emission from below 1GHz.

9kHz ~ 30MHz

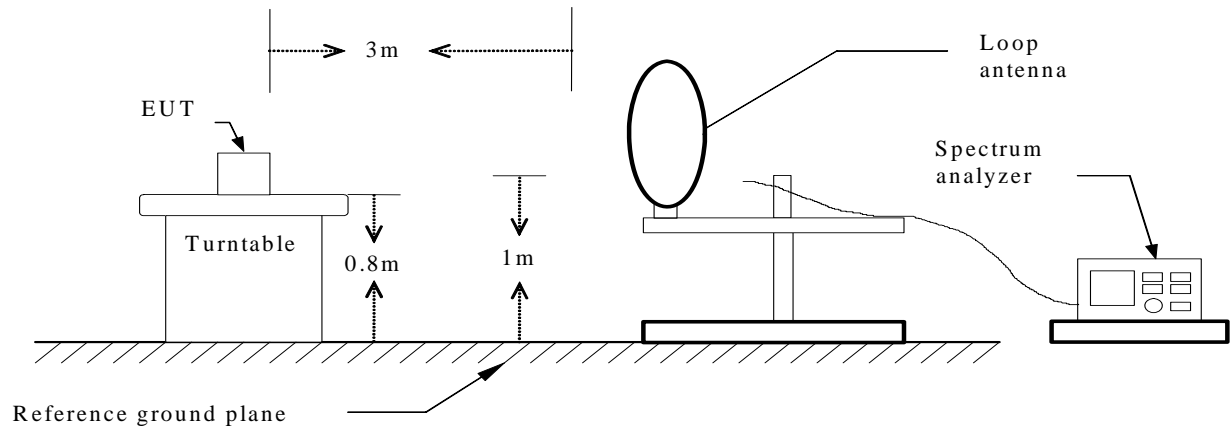

30MHz ~ 1GHz

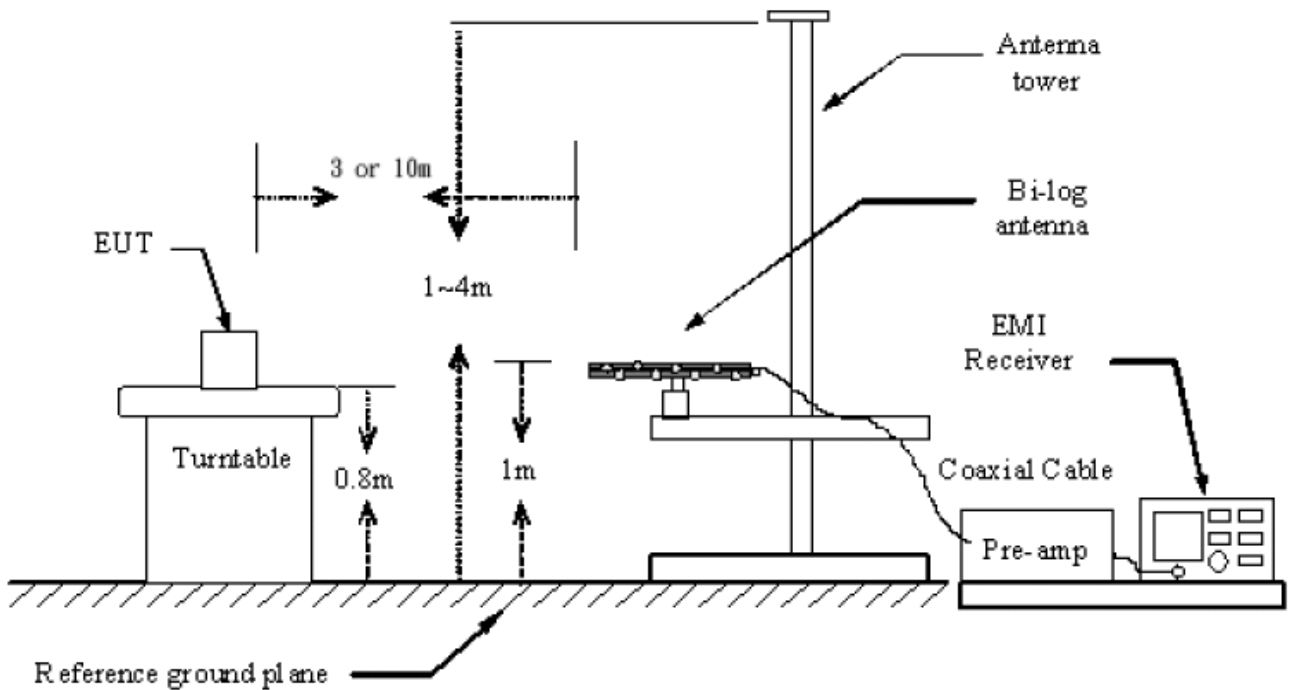

The diagram below shows the test setup that is utilized to make the measurements for emission above 1GHz.

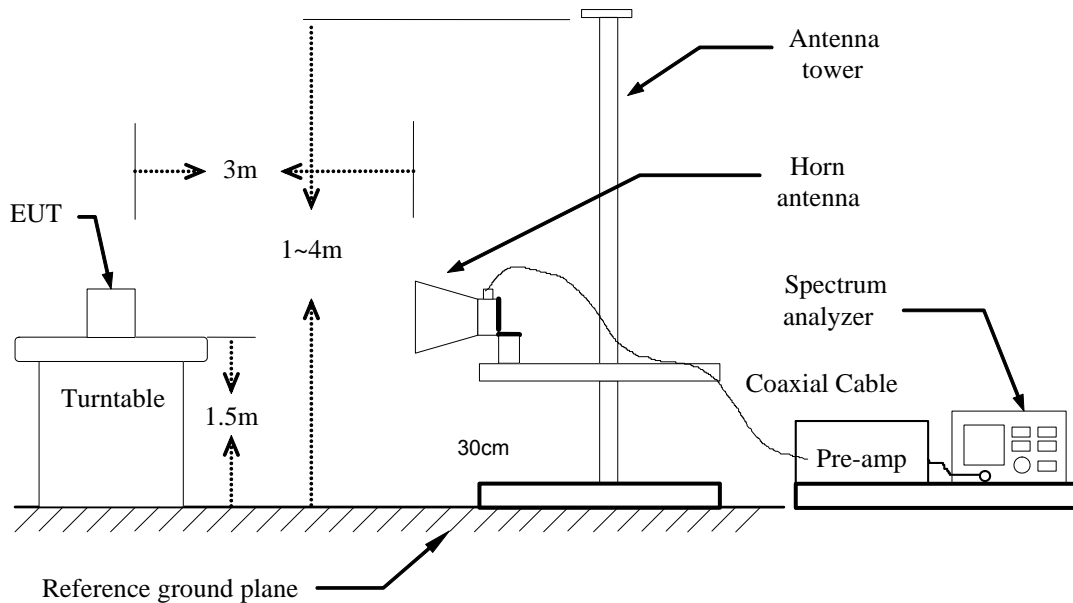

TEST PROCEDURE

- The EUT was placed on the top of a rotating table 1.5 meters above the ground at a 10 meter chamber test site. The table was rotated 360 degrees to determine the position of the highest radiation.
- While measuring the radiated emission below 1GHz, the EUT was set 3 or 10 meters away from the interference-receiving antenna, which was mounted on the top of a variable-height antenna tower. While measuring the radiated emission above 1GHz, the EUT was set 3 or 10 meters away from the interference-receiving antenna.
- The antenna is a broadband antenna, and its height is varied from one meter to four meters above the ground to determine the maximum value of the field strength. Both horizontal and vertical polarization of the antenna are set to make the measurement.
- For each suspected emission, the EUT was arranged to its worst case and then the antenna was tuned to heights from 1 meter to 4 meters and the table was turned from 0 degrees to 360 degrees to find the maximum reading.
- The test-receiver system was set to Peak Detect Function and Specified Bandwidth with Maximum Hold Mode.
- If the emission level of the EUT in peak mode was 10 dB lower than the limit specified, then testing could be stopped and the peak values of the EUT would be reported. Otherwise the emissions that did not have 10 dB margin would be re-tested one by one using peak, quasi-peak or average method as specified and then reported in a data sheet.

Note :

- The resolution bandwidth and video bandwidth of test receiver/spectrum analyzer is 120 KHz for Peak detection (PK) and Quasi-peak detection (QP) at frequency below 1GHz.
- The resolution bandwidth and video bandwidth of test receiver/spectrum analyzer is 1 MHz for Peak detection and frequency above 1GHz.
- The resolution bandwidth of test receiver/spectrum analyzer is 1 MHz and the video bandwidth is 510 Hz for Average detection (AV) at frequency above 1GHz.

7.7.2 WORST-CASE RADIATED EMISSION BELOW 1 GHz

BELOW 1 GHz (9kHz ~ 30MHz)

No emission found between lowest internal used/generated frequency to 30MHz.

BELOW 1 GHz (30MHz ~ 1GHz)

Product Name	LINX	Test Date	2017/03/30
Model Name	1.0	Test By	Peter Chu
Test Mode	Normal Operation (worst case)	Temp & Humidity	23.7°C, 62%

Vertical

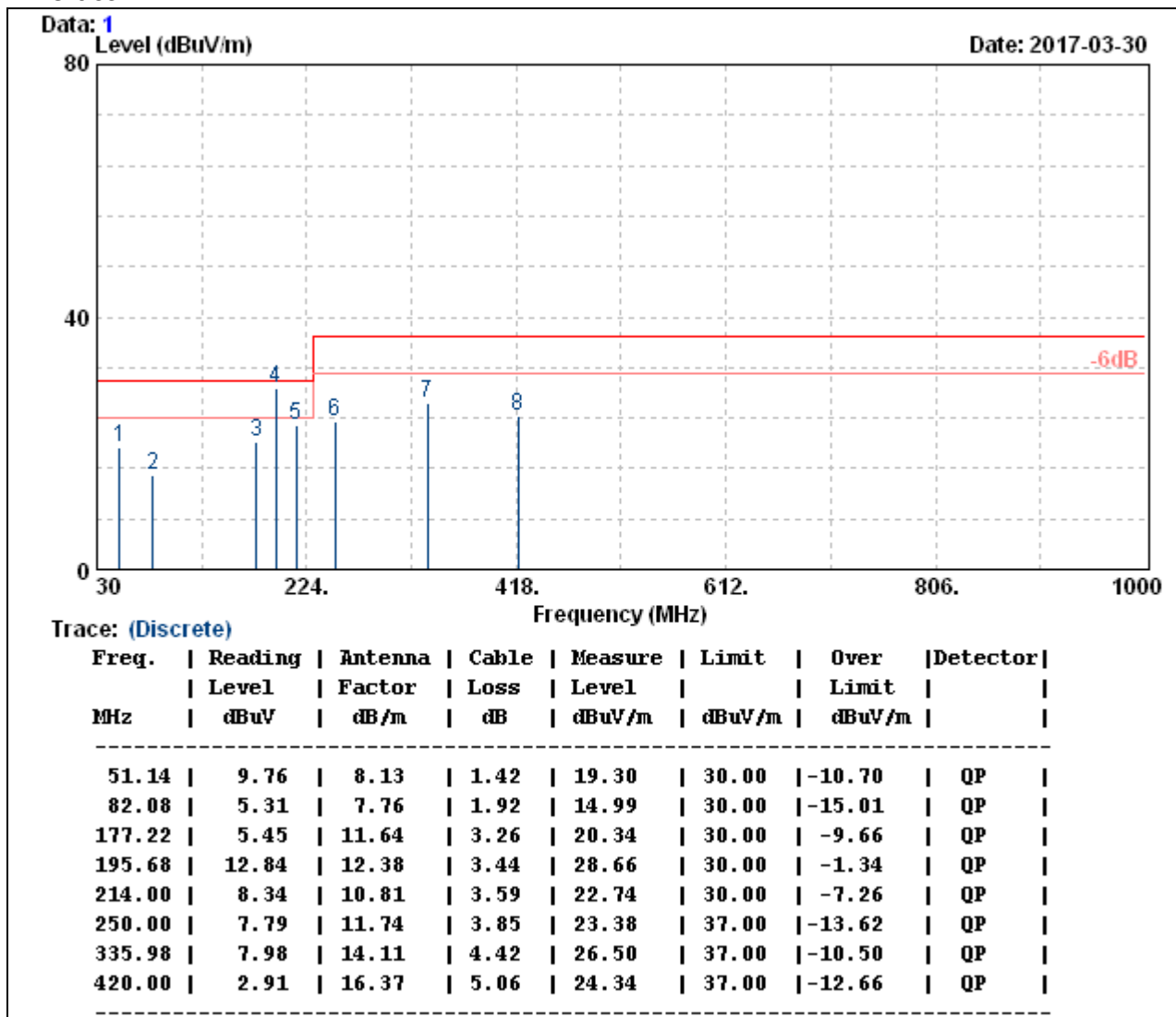

Remark:

1. No emission found between lowest internal used/generated frequency to 30MHz (9kHz~30MHz).
2. Radiated emissions measured were made with an instrument using peak/quasi-peak detector mode.
3. Quasi-peak test would be performed if the peak result were greater than the quasi-peak limit or as required by the applicant.
4. Measurements above show only up to 6 maximum emissions noted, or would be lesser, with " N/A " remark, if no specific emissions from the EUT are recorded (ie: margin>20dB from the applicable limit) and considered that's already beyond the background noise floor.
5. Margin (dB) = Remark result (dBUV/m) – Quasi-peak limit (dBUV/m).



Product Name	LINX	Test Date	2017/03/30
Model Name	1.0	Test By	Peter Chu
Test Mode	Normal Operation (worst case)	Temp & Humidity	23.7°C, 62%

Horizontal

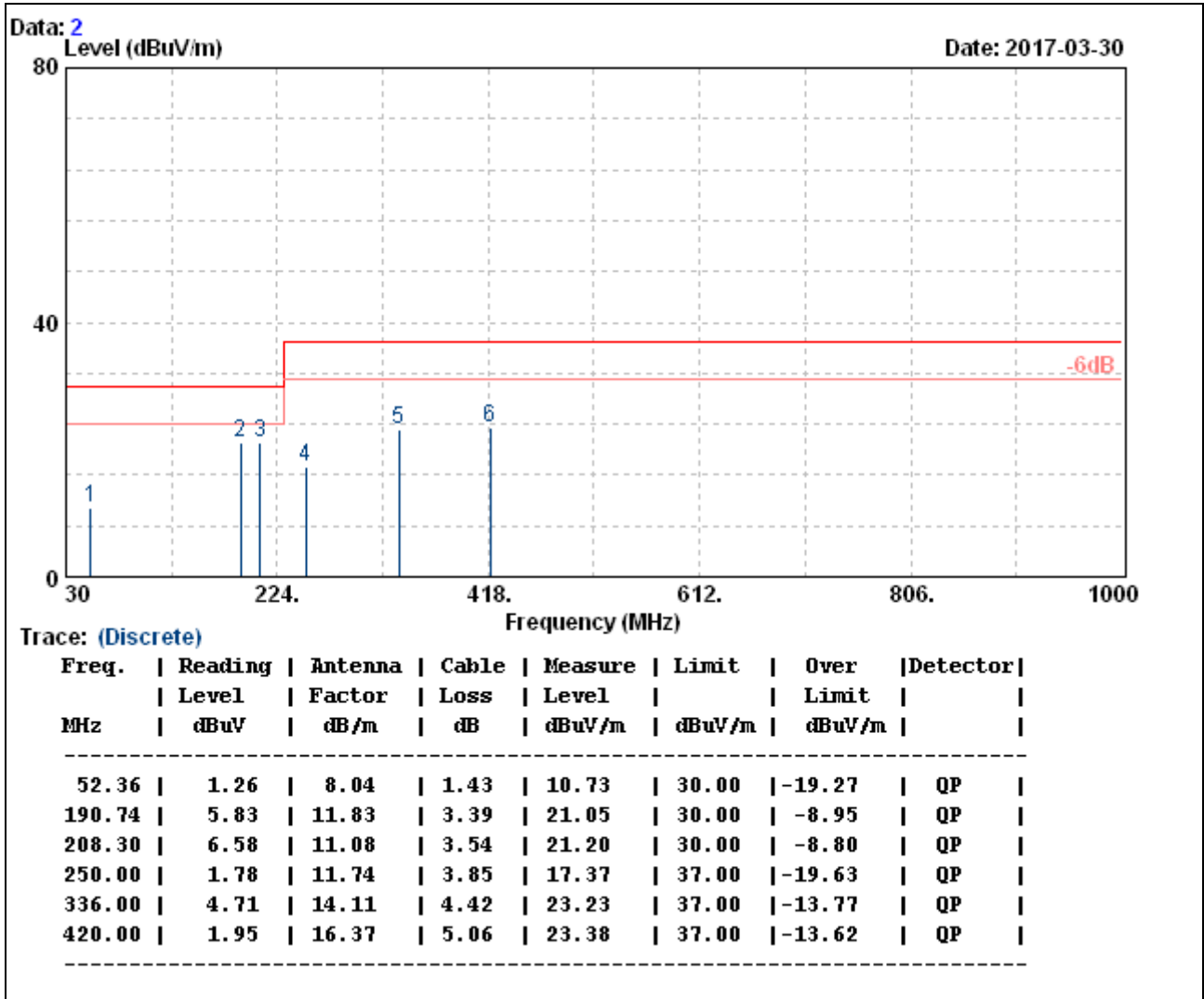

Remark:

1. No emission found between lowest internal used/generated frequency to 30MHz (9kHz~30MHz).
2. Radiated emissions measured were made with an instrument using peak/quasi-peak detector mode.
3. Quasi-peak test would be performed if the peak result were greater than the quasi-peak limit or as required by the applicant.
4. Measurements above show only up to 6 maximum emissions noted, or would be lesser, with " N/A " remark, if no specific emissions from the EUT are recorded (ie: margin>20dB from the applicable limit) and considered that's already beyond the background noise floor.
5. Margin (dB) = Remark result (dBuV/m) – Quasi-peak limit (dBuV/m).

7.7.3 TRANSMITTER RADIATED EMISSION ABOVE 1 GHz

Product Name	LINX	Test Date	2017/03/30
Model Name	1.0	Test By	Ted Huang
Test Mode	CH Low TX / $\pi/4$ DQPSK	Temp & Humidity	26.8°C, 54%

Horizontal

	TX mode / CH Low				Measurement Distance at 3m				Horizontal polarity	
	Freq. (MHz)	Reading (dB μ V)	AF (dB/m)	Cable Loss (dB)	Pre-amp (dB)	Filter (dB)	Level (dB μ V/m)	Limit (dB μ V/m)	Margin (dB)	Mark (P/Q/A)
*	1141.35	63.49	25.17	1.82	44.40	0.00	0.42	46.49	74.00	-27.51
*	1141.35	53.83	25.17	1.82	44.40	0.00	0.42	36.83	54.00	-17.17
	1937.28	60.52	29.92	2.44	44.64	0.00	0.92	49.17	74.00	-24.83
	1937.28	52.21	29.92	2.44	44.64	0.00	0.92	40.85	64.74	-23.89
*	4804.15	58.24	33.79	4.06	43.87	0.00	0.22	52.45	74.00	-21.55
*	4804.15	49.80	33.79	4.06	43.87	0.00	0.22	44.01	54.00	-9.99

Vertical

	TX mode / CH Low				Measurement Distance at 3m				Vertical polarity	
	Freq. (MHz)	Reading (dB μ V)	AF (dB/m)	Cable Loss (dB)	Pre-amp (dB)	Filter (dB)	Level (dB μ V/m)	Limit (dB μ V/m)	Margin (dB)	Mark (P/Q/A)
*	1231.28	62.11	25.53	1.90	44.50	0.00	0.43	45.46	74.00	-28.54
*	1231.28	55.27	25.53	1.90	44.50	0.00	0.43	38.62	54.00	-15.38
	1932.58	58.44	29.89	2.43	44.64	0.00	0.91	47.04	74.00	-26.96
	1932.58	52.57	29.89	2.43	44.64	0.00	0.91	41.16	60.78	-19.61
*	4803.88	57.43	33.79	4.06	43.87	0.00	0.22	51.63	74.00	-22.37
*	4803.88	48.25	33.79	4.06	43.87	0.00	0.22	42.46	54.00	-11.54

Remark:

1. AF: Antenna Factor, Cable: Cable Loss, Pre-Amp: Preamplifier gain, Filter: High Pass Filter Insertion Loss (3.5GHz)
2. Spectrum analyzer setting P(Peak): RBW=1MHz, VBW=1MHz, A(Average): RBW=1MHz, VBW=510Hz
3. The result basic equation calculation is as follow:
 Level = Reading + AF + Cable – Preamp + Filter, Margin = Level-Limit
4. The other emission levels were 20dB below the limit
5. The test limit distance is 3M limit.



Product Name	LINX	Test Date	2017/03/30
Model Name	1.0	Test By	Ted Huang
Test Mode	CH Mid TX / $\pi/4$ DQPSK	Temp & Humidity	26.8°C, 54%

Horizontal

	TX mode / CH Mid				Measurement Distance at 3m				Horizontal polarity	
	Freq.	Reading	AF	Cable Loss	Pre-amp	Filter	Level	Limit	Margin	Mark
	(MHz)	(dB μ V)	(dB/m)	(dB)	(dB)	(dB)	(dB μ V/m)	(dB μ V/m)	(dB)	(P/Q/A)
*	1141.42	63.72	25.17	1.82	44.40	0.00	0.42	46.73	74.00	-27.27
*	1141.42	54.25	25.17	1.82	44.40	0.00	0.42	37.26	54.00	-16.74
	1937.36	60.68	29.92	2.44	44.64	0.00	0.92	49.32	74.00	-24.68
	1937.36	52.36	29.92	2.44	44.64	0.00	0.92	41.00	63.90	-22.89
*	4881.86	58.38	34.07	4.11	43.91	0.00	0.23	52.88	74.00	-21.12
*	4881.86	49.96	34.07	4.11	43.91	0.00	0.23	44.46	54.00	-9.54

Vertical

	TX mode / CH Mid				Measurement Distance at 3m				Vertical polarity	
	Freq.	Reading	AF	Cable Loss	Pre-amp	Filter	Level	Limit	Margin	Mark
	(MHz)	(dB μ V)	(dB/m)	(dB)	(dB)	(dB)	(dB μ V/m)	(dB μ V/m)	(dB)	(P/Q/A)
*	1231.23	62.26	25.52	1.90	44.50	0.00	0.43	45.62	74.00	-28.38
*	1231.23	55.42	25.52	1.90	44.50	0.00	0.43	38.78	54.00	-15.22
	1932.50	59.25	29.89	2.43	44.64	0.00	0.91	47.85	74.00	-26.15
	1932.50	52.72	29.89	2.43	44.64	0.00	0.91	41.32	59.77	-18.45
*	4882.08	57.66	34.08	4.11	43.91	0.00	0.23	52.17	74.00	-21.83
*	4882.08	48.35	34.08	4.11	43.91	0.00	0.23	42.85	54.00	-11.15

Remark:

1. AF: Antenna Factor, Cable: Cable Loss, Pre-Amp: Preamplifier gain, Filter: Insertion Loss of Filter (2.5GHz)
2. Spectrum analyzer setting P(Peak): RBW=1MHz, VBW=1MHz, A(Average): RBW=1MHz, VBW=10Hz
3. The result basic equation calculation is as follow:
Level = Reading + AF + Cable – Preamp + Filter, Margin = Level-Limit
4. The other emission levels were 20dB below the limit
5. The test limit distance is 3M limit.

Product Name	LINX	Test Date	2017/03/30
Model Name	1.0	Test By	Ted Huang
Test Mode	CH High TX / $\pi/4$ DQPSK	Temp & Humidity	26.8°C, 54%

Horizontal

TX mode / CH High				Measurement Distance at 3m				Horizontal polarity	
Freq.	Reading	AF	Cable Loss	Pre-amp	Filter	Level	Limit	Margin	Mark
(MHz)	(dB μ V)	(dB/m)	(dB)	(dB)	(dB)	(dB μ V/m)	(dB μ V/m)	(dB)	(P/Q/A)
* 1141.26	63.72	25.17	1.82	44.40	0.00	0.42	46.72	74.00	-27.28
* 1141.26	53.94	25.17	1.82	44.40	0.00	0.42	36.94	54.00	-17.06
1937.37	60.62	29.92	2.44	44.64	0.00	0.92	49.26	74.00	-24.74
1937.37	52.48	29.92	2.44	44.64	0.00	0.92	41.12	62.51	-21.39
* 4959.86	58.52	34.36	4.16	43.95	0.00	0.24	53.32	74.00	-20.68
* 4959.86	50.13	34.36	4.16	43.95	0.00	0.24	44.93	54.00	-9.07

Vertical

TX mode / CH High				Measurement Distance at 3m				Vertical polarity	
Freq.	Reading	AF	Cable Loss	Pre-amp	Filter	Level	Limit	Margin	Mark
(MHz)	(dB μ V)	(dB/m)	(dB)	(dB)	(dB)	(dB μ V/m)	(dB μ V/m)	(dB)	(P/Q/A)
* 1231.35	62.08	25.53	1.90	44.50	0.00	0.43	45.43	74.00	-28.57
* 1231.35	55.33	25.53	1.90	44.50	0.00	0.43	38.68	54.00	-15.32
1932.52	58.58	29.89	2.43	44.64	0.00	0.91	47.18	74.00	-26.82
1932.52	52.72	29.89	2.43	44.64	0.00	0.91	41.32	58.41	-17.10
* 4960.06	57.46	34.36	4.16	43.95	0.00	0.24	52.26	74.00	-21.74
* 4960.06	48.38	34.36	4.16	43.95	0.00	0.24	43.18	54.00	-10.82

Remark:

1. AF: Antenna Factor, Cable: Cable Loss, Pre-Amp: Preamplifier gain, Filter: Insertion Loss of Filter (2.5GHz)
2. Spectrum analyzer setting P(Peak): RBW=1MHz, VBW=1MHz, A(Average): RBW=1MHz, VBW=10Hz
3. The result basic equation calculation is as follow:
 Level = Reading + AF + Cable – Preamp + Filter, Margin = Level-Limit
4. The other emission levels were 20dB below the limit
5. The test limit distance is 3M limit.

7.7.4 RESTRICTED BAND EDGES

Detector Mode : Peak

Polarity : Horizontal

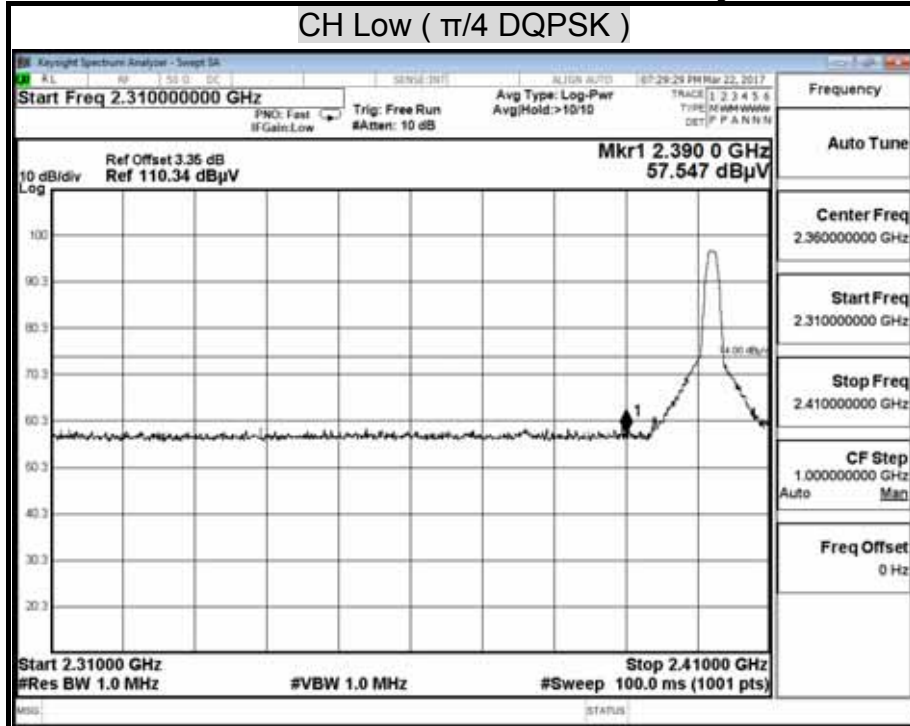

Detector Mode : Average

Polarity : Horizontal

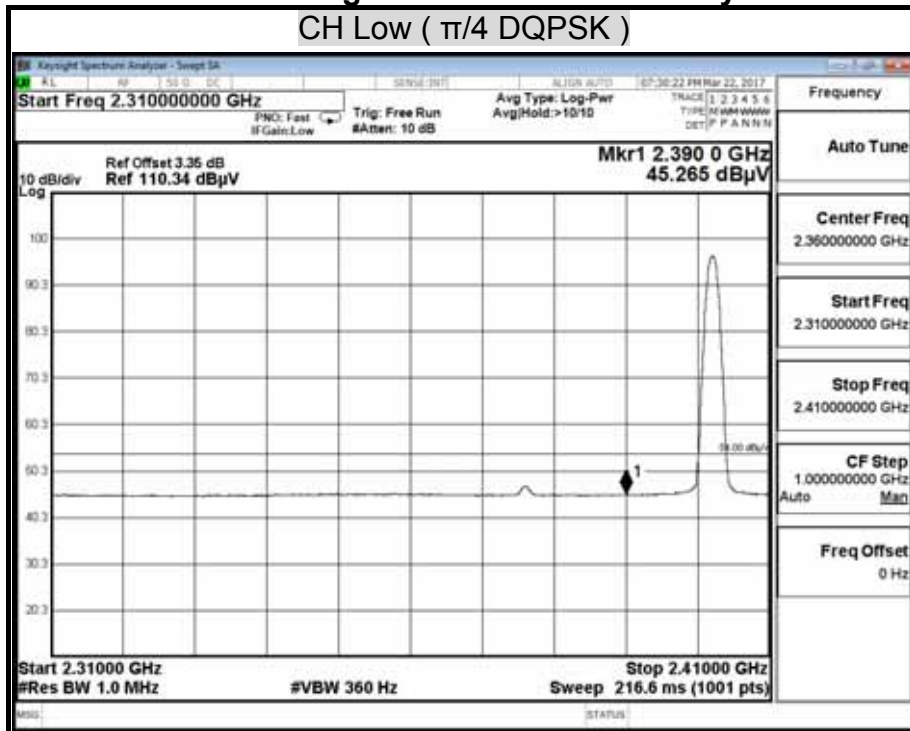

Detector Mode : Peak **Polarity : Vertical**

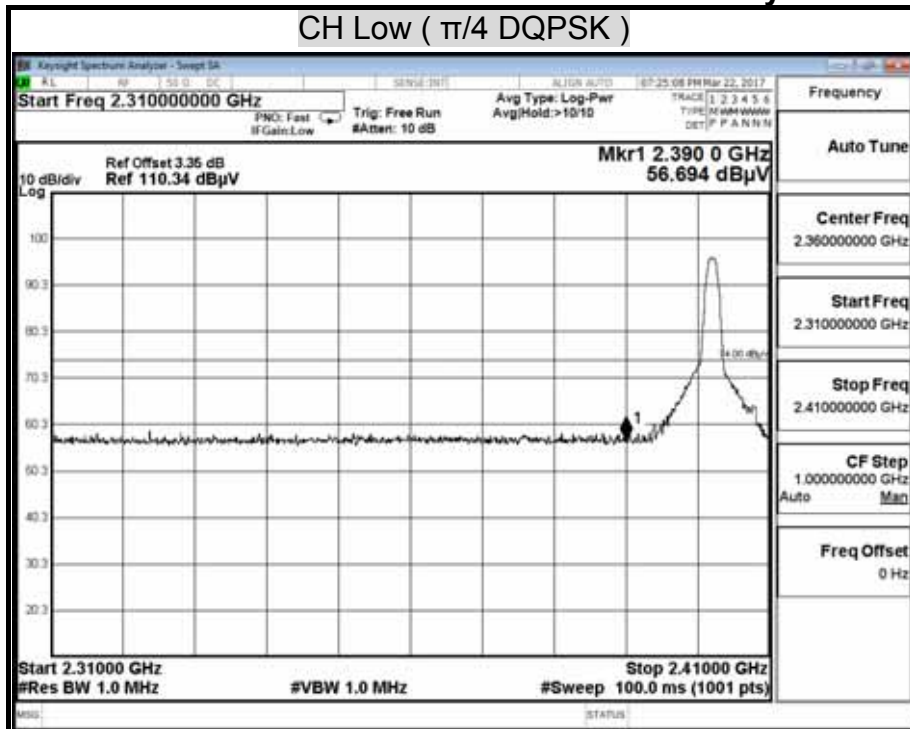

Detector Mode : Average **Polarity : Vertical**

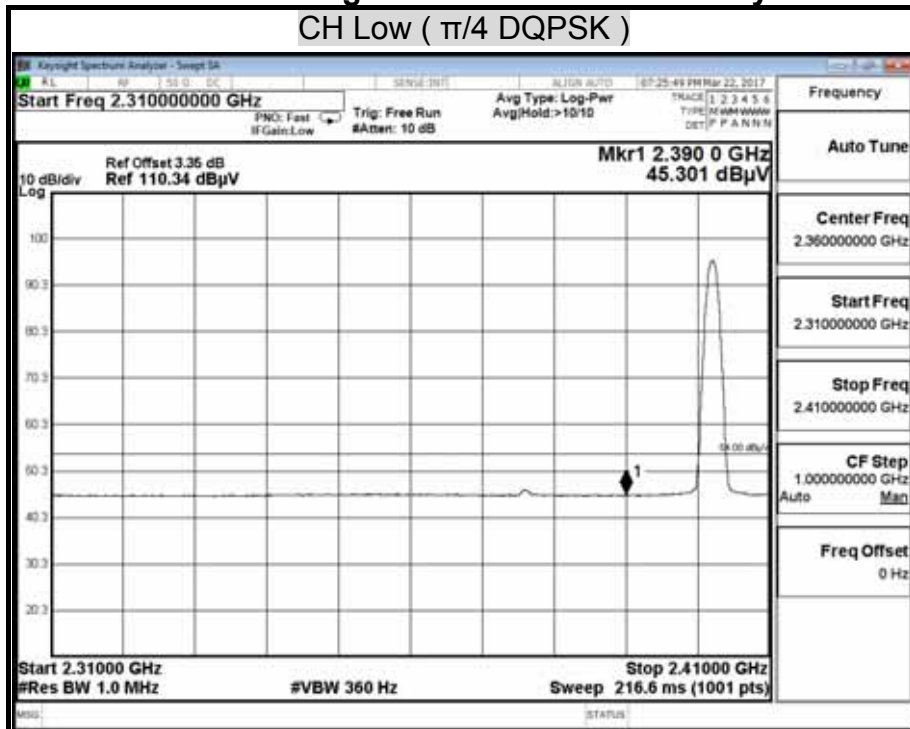



Detector Mode : Peak **Polarity : Horizontal**

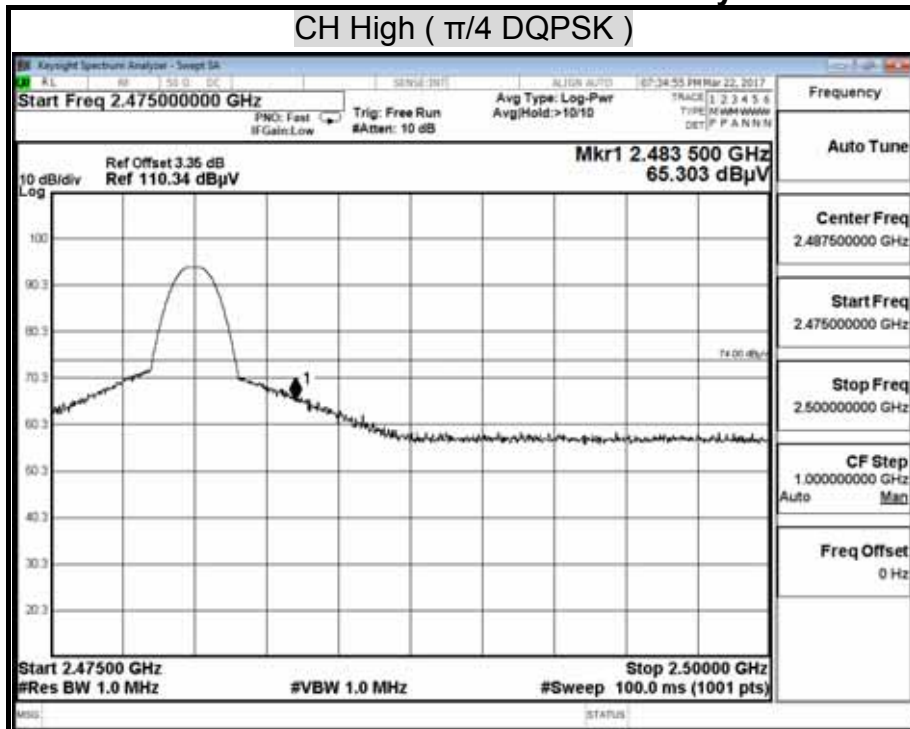

Detector Mode : Average **Polarity : Horizontal**

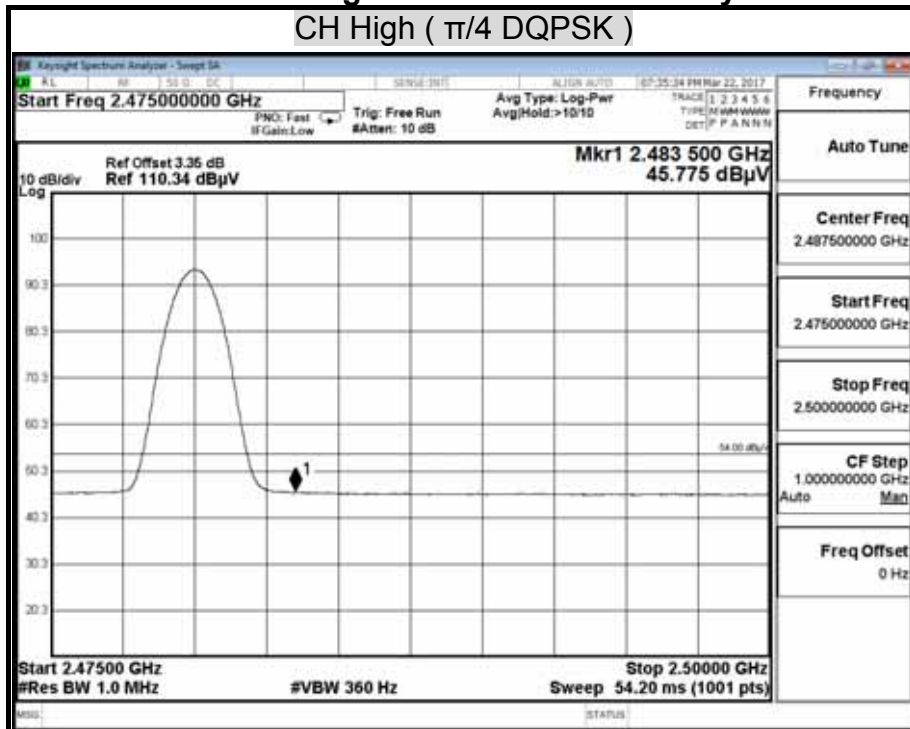

Detector Mode : Peak

Polarity : Vertical

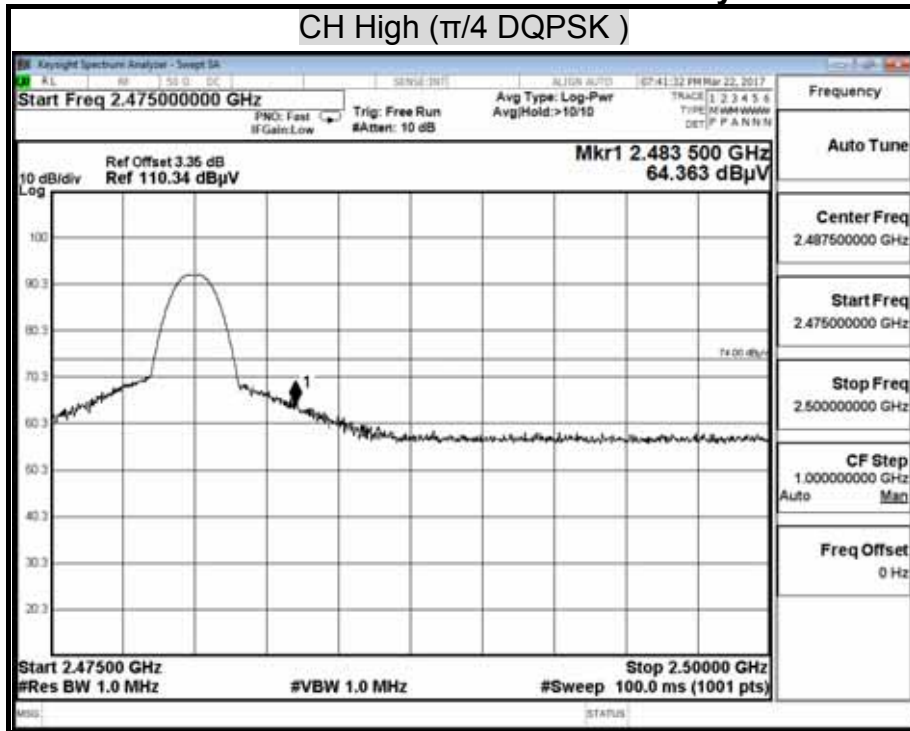

Detector Mode : Average

Polarity : Vertical

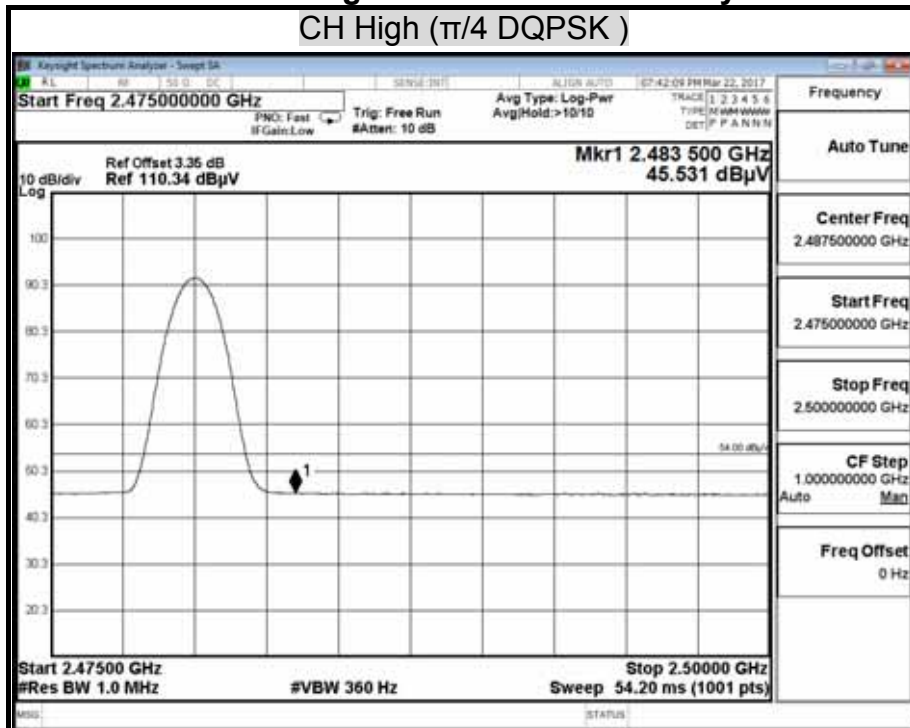

7.8 POWERLINE CONDUCTED EMISSIONS

LIMITS

§ 15.207 (a) Except as shown in paragraph (b) and (c) this section, for an intentional radiator that is designed to be connected to the public utility (AC) power line, the radio frequency voltage that is conducted back onto the AC power line on any frequency or frequencies within the band 150 kHz to 30 MHz shall not exceed the limits in the following table, as measured using a 50 μ H/50 ohms line impedance stabilization network (LISN). Compliance with the provisions of this paragraph shall be based on the measurement of the radio frequency voltage between each power line and ground at the power terminal.

The lower limit applies at the boundary between the frequency ranges.

Frequency of Emission (MHz)	Conducted limit (dB μ v)	
	Quasi-peak	Average
0.15 - 0.5	66 to 56	56 to 46
0.5 - 5	56	46
5 - 30	60	50

TEST EQUIPMENT

Conducted Emission room #1				
Name of Equipment	Manufacturer	Model	Serial Number	Calibration Due
BNC Coaxial Cable	CCS	BNC50	11	01/12/2018
EMI Test Receiver	R&S	ESCS 30	100348	12/11/2017
LISN	SCHWARZBECK	NNLK8130	8130124	11/07/2017
LISN	FCC	FCC-LISN-50-32-2	08009	05/03/2017
Pulse Limiter	R&S	ESH3-Z2	100116	01/12/2018
Software	e-3 (5.04211j)			

Remark: Each piece of equipment is scheduled for calibration once a year.

TEST SETUP

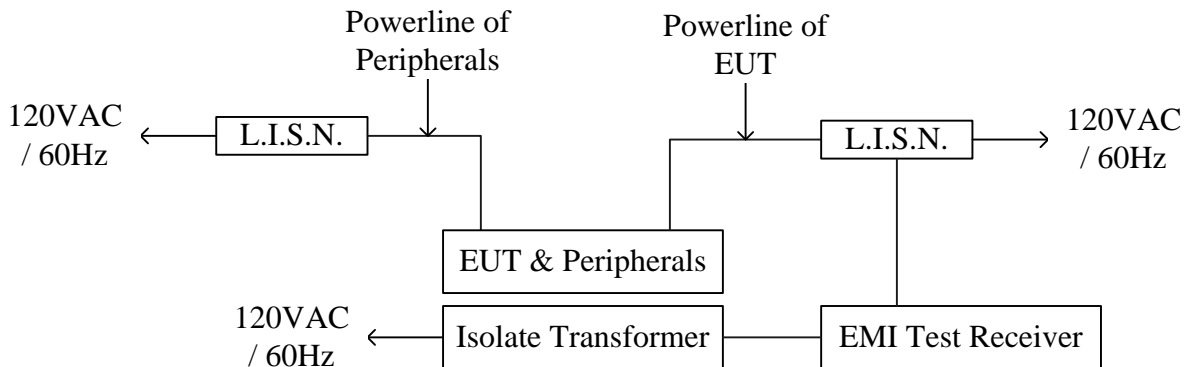
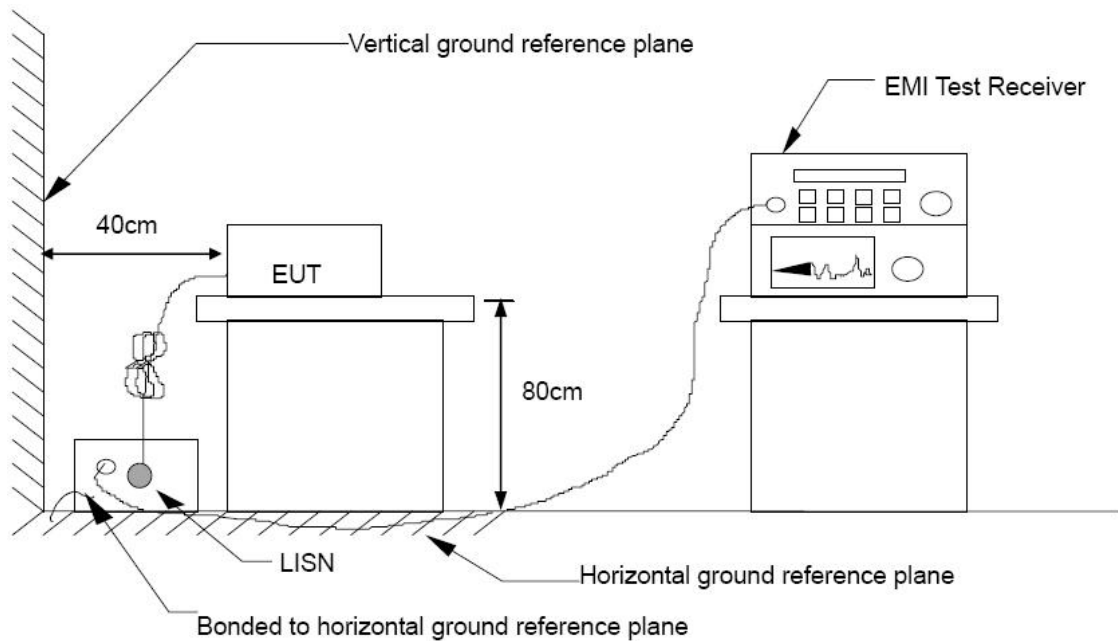

TEST PROCEDURE

The EUT is placed on a non-conducting table 40 cm from the vertical ground plane and 80cm above the horizontal ground plane. The EUT IS CONFIGURED IN ACCORDANCE WITH ANSI C63.10 : 2013.

The resolution bandwidth is set to 9 kHz for both quasi-peak detection and average detection measurements.

Line conducted data is recorded for both NEUTRAL and LINE.

TEST RESULTS

Product Name	LINX	Test Date	2017/03/24
Model Name	1.0	Test By	Event Cheng
Test Mode	Normal Operation	Temp & Humidity	24°C, 57%

LINE

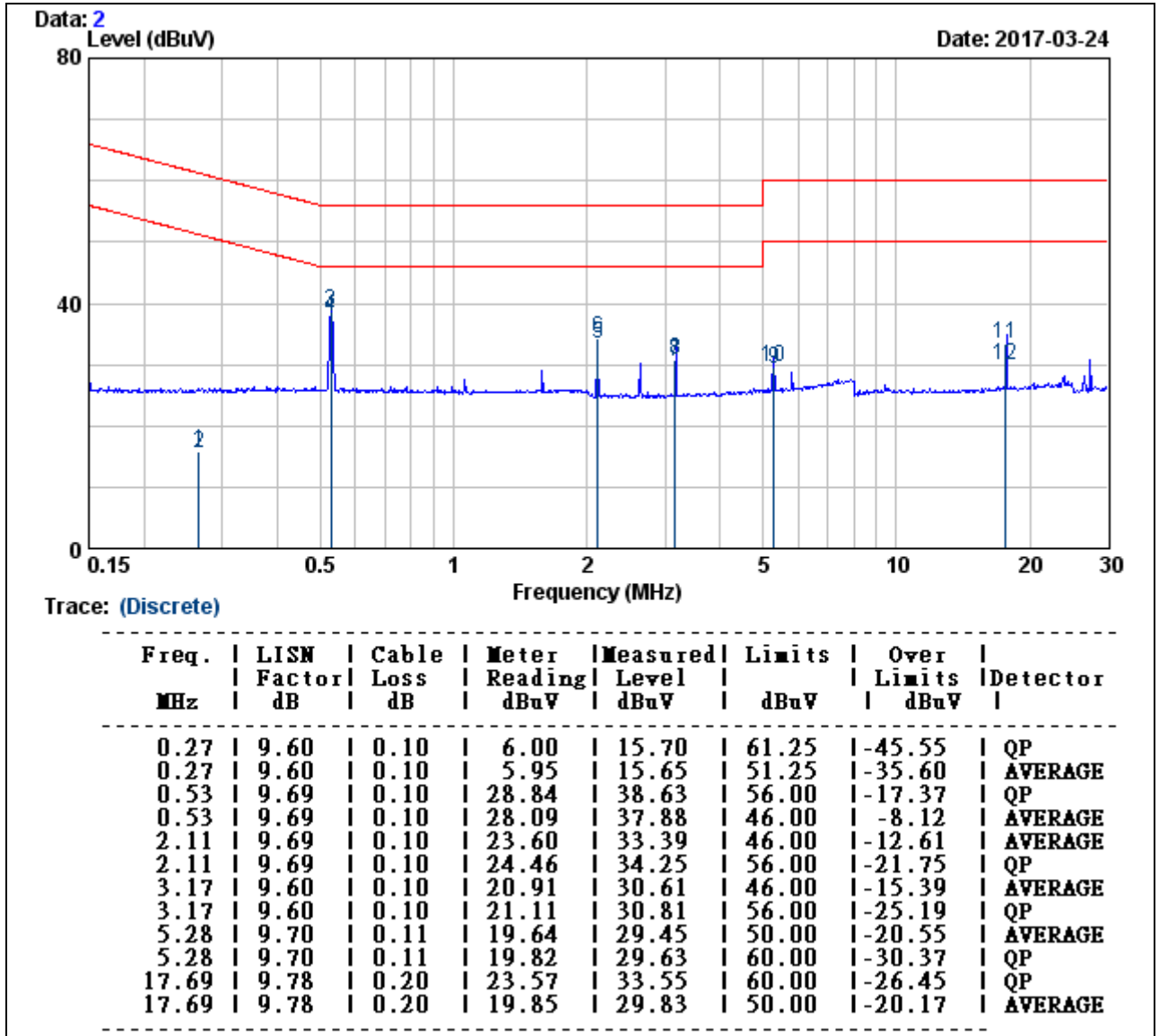

Remark:

1. Correction Factor = Insertion loss + Cable loss
2. Emission level = Reading Value + Correction factor
3. Margin value = Emission level – Limit value

Product Name	LINX	Test Date	2017/03/24
Model Name	1.0	Test By	Event Cheng
Test Mode	Normal Operation	Temp & Humidity	24°C, 57%

NEUTRAL

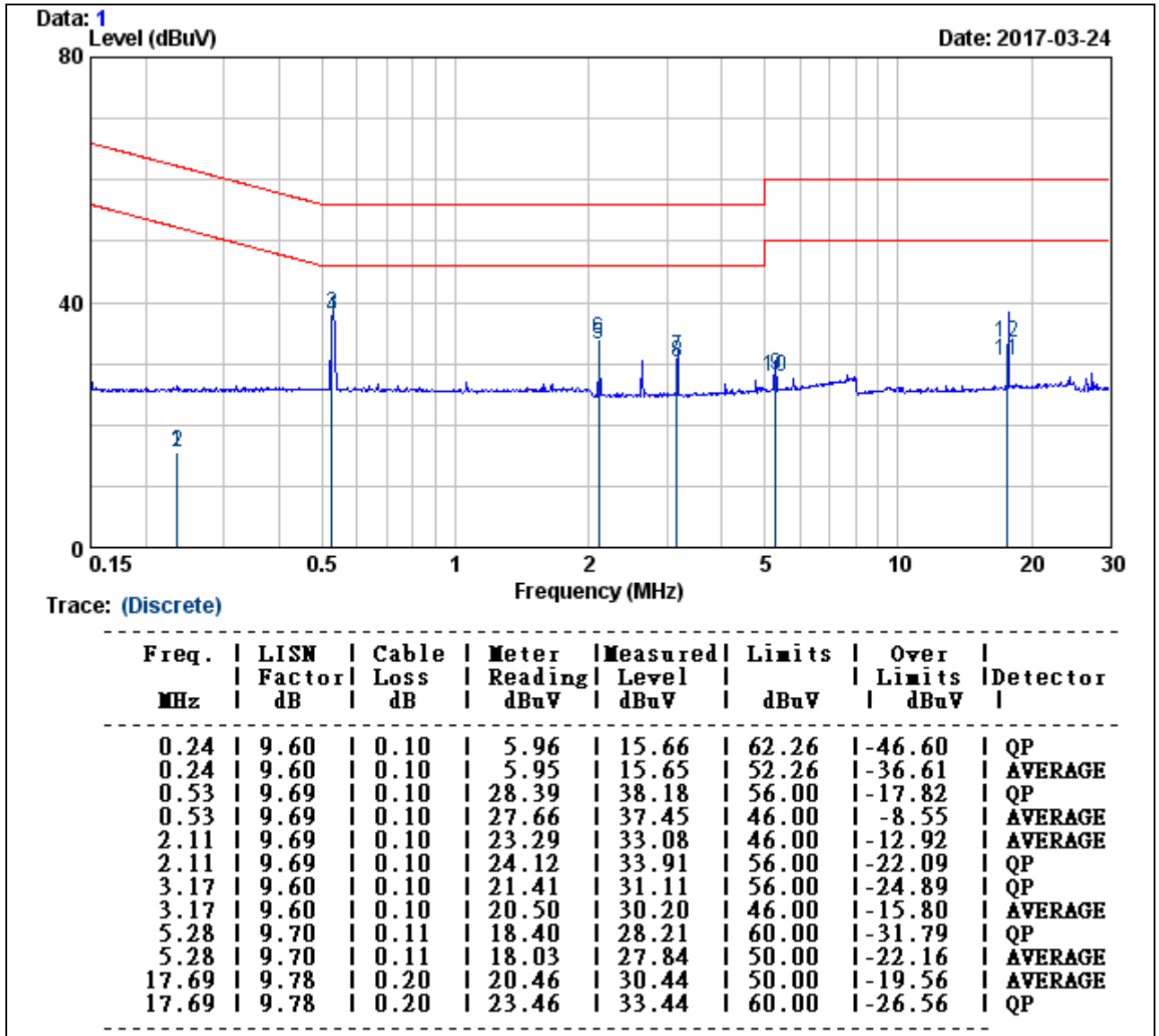

Remark:

1. Correction Factor = Insertion loss + Cable loss
2. Emission level = Reading Value + Correction factor
3. Margin value = Emission level – Limit value