

RILEY

S C O O T E R S



RS2 User Manual



Thank you for choosing a Riley Scooter. We are a British start-up with an ambitious vision. Your electric ride truly makes a difference. With increasing urban traffic and environmental issues throughout the world, you are supporting us to achieve our mission of providing “a viable way forward for smarter, cleaner cities”. Riley Scooters is reinventing urban transportation leading to a positive environmental difference in the world through our all-electric scooter revolution.

Whilst the e-scooter may be just a pleasure ride for some, it's the modern way of transport. We hope this e-scooter brings you as much satisfaction riding it, as it did for us creating it.

Contribute to our mission by sharing images and videos of your rides using the hashtag #rileyscooters. Together, let's lead the way forward for modern urban transport creating a clean and sustainable future for all.

Hayden Riley
Founder & CEO

Proudly
British 

Declaration of conformity



Riley Scooters Limited: Kings Lodge, London Road, Sevenoaks,
TN15 6AR, United Kingdom

This declaration of conformity is issued under the sole responsibility
of the manufacturer.

Object of the declaraton:

Type of device: Electric scooter

Model NO: RS2

Description: RILEY SCOOTER RS2

**The object of the declaration described above is in conformity with
the relevant Union harmonisation legislation:**

2011/65/EU amended by 2015/863(EU)

2014/30/EU

2014/35/EU

2006/42/EC

2014/53/EU

RoHS directive

EMC Directive

Low Voltage Directive

Machinery Directive

RED DIRECTIVE

**References to the relevant harmonize standards used or
references to other technical specification in relation to which
conformity is declared:**

BS EN 17128:2020

EN 17128:2020

EN 60335-1:2012

EN 60335-2-29:2004

EN IEC 55014-1:2021

EN IEC 55014-2:2021

EN 61558-1:2005

EN 61558-2-16:2009

EN 55014-1:2021

EN 55014-2:2015

EN 61000-3-2:2019+A1:2021

EN 61000-3-3:2013+A1:2019

Name of manufacturer: RILEY SCOOTERS LIMITED

Address: Kings Lodge, London Road, Sevenoaks, TN16 5AR,
United Kingdom

Importer/Distributor contact detail:

www.rileyscooters.com 

AUTHORISED SIGNATURE: 

Hayden Riley

Founder & CEO

Date: 2022-10-28

About the manual

For your driving safety, please read this user manual carefully before using the e-scooter.

Please note “warnings” and “tips” in this manual.

Warnings: Improper operation may result in personal injury.

Tips: Helpful advice for the usage of the e-scooter.

Should you have any queries, please contact our customer support team via our website (rileyscooters.com).



WARNING!

Improper use of the e-scooter and/or failure to read this user manual may lead to serious bodily injury. Riley Scooters will take no responsibility for any injuries caused by improper use.



WARNING!

Note: It is important to pump the tyres up to 35 P.S.I (2.41 Bar) for your own safety and optimal riding quality.

Tips:

The manufacturer recommends riders be 14+ years old.

People without experience, or with impaired physical ability should learn to ride with a competent rider.

Children should only clean and maintain the e-scooter under adult supervision.

Contents

1.	Safety notes	7-8
1.1	About safety	7
1.2	Safety precautions	7-9
2.	Product information	10-14
2.1	Overall view	10
2.2	Operation of buttons	11
2.3	Assembly instructions	12
2.4	Folding instructions	13
2.5	Uninstall/install the battery	14
3.	How to ride the e-scooter	15-16
4.	Battery instruction	17-19
4.1	Battery parameters	17
4.2	Battery safety	18
4.3	Charging instructions	19
5.	Specification	20
6.	Maintenance	21
7.	Trouble shooting	22
8.	What's included	23
9.	Riley Scooter APP	24

1. Safety notes

1.1 About safety

There are risks involved with riding an e-scooter. For your safety, please learn to ride safely and obey the local rules/laws.

Please check the tyres for damage and that fixings are tight before riding. Please contact your local distributor for any safety queries.

Please do not do anything that may harm other people or their property with the e-scooter.

Any conversion of the e-scooter is prohibited as it will change its performance or damage the structure, which may cause serious injury.

Please do not submerge the e-scooter into water, which will not only damage the e-scooter, but also cause a safety risk.

1.2 Safety precautions

Please note that you may lose balance, or fall over when you ride an e-scooter. To avoid injury, you should familiarise yourself with this manual and keep the e-scooter in good condition.



 Safety measures should be taken before riding, e.g: wear sportswear, helmet, knee pads and elbow pads.



 Take caution when riding in the rain.



 DO NOT ride with loading. DO NOT ride with more than one rider.



 Do not ride if you are pregnant.



 Max Load: 100 kg.



 DO NOT ride after drinking alcohol or taking medicine.

2. Product information

2.1 Overall view

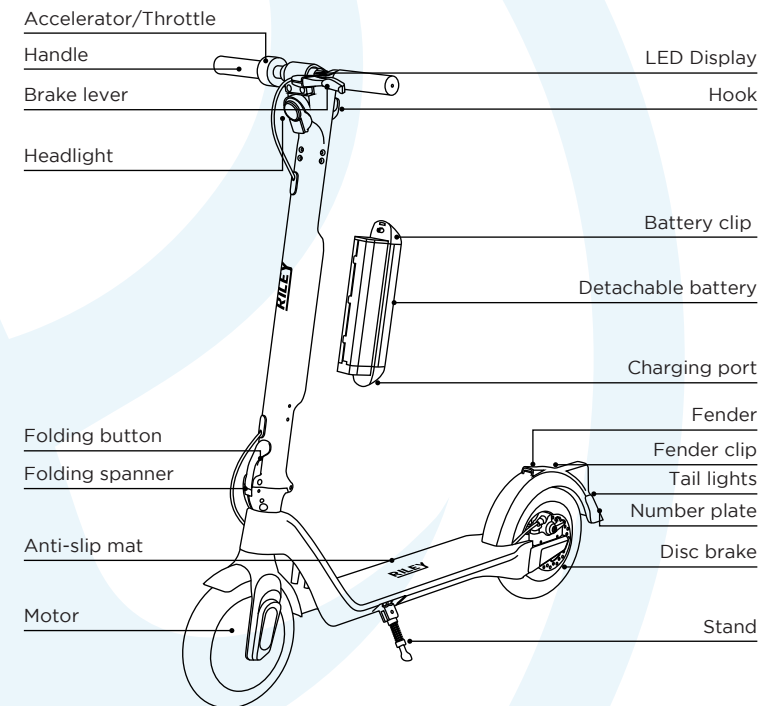

! DO NOT listen to music when you ride the e-scooter.



! Be careful of uneven, loose or slippery surfaces. Avoid slopes, stairs and poorly lit areas.



! DO NOT use in dangerous areas, where there is a risk from flammable materials.

2.2 Operation of buttons

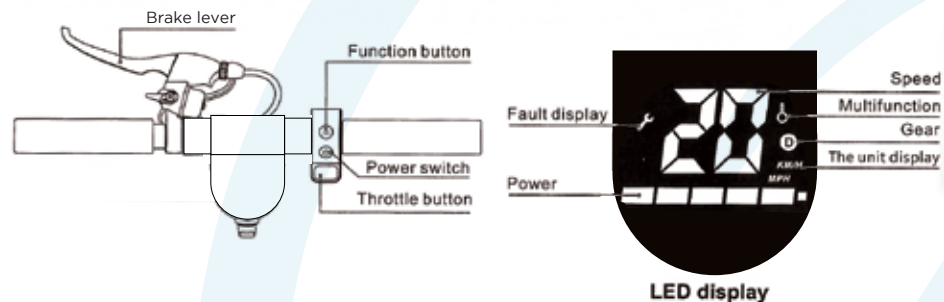

Power Switch: Press and hold the power button to turn on/off.

Function button:

A. Press function key to switch riding modes.

Beginner mode (10km/h limit).
Gear indicator is not displayed.

Normal mode (15km/h limit).
Gear indicator shows white.

Sports mode (25km/h limit).
Gear indicator shows red.

B. Press the function key twice to turn the headlights on/off.
The taillights are always on.

Throttle: Press down the throttle button to accelerate.

Brake: Apply pressure to the brake lever to brake. Lightly step on the rear fender to assist the brakes.

Cruise mode: Maintain a set speed for 6 seconds to enter the cruise mode. Exit the cruise mode by pressing down the throttle again, or by braking.

2.3 Assembly instructions

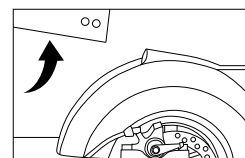

1. Pull up the stem towards the front wheel.

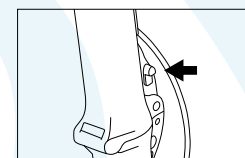

2. Fold clip in firmly, ensuring it clicks and button is tight.

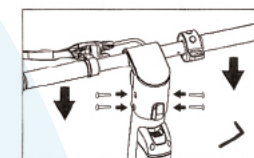

3. Attach headset to the stem, then screw in 2 screws each side using the Allen key provided.

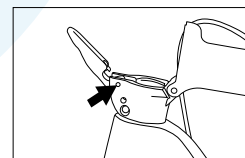

Note: If the mechanism becomes loose, tighten the screw accordingly.

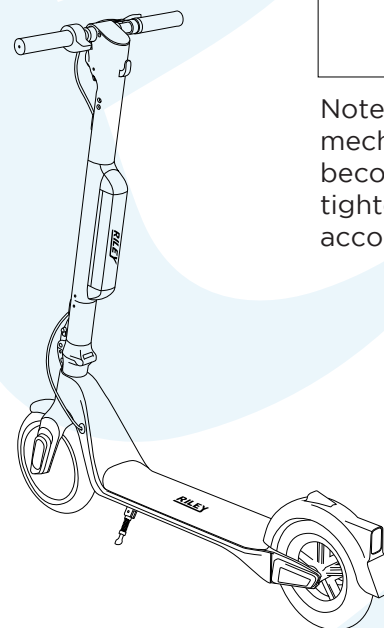

2.4 Folding instructions

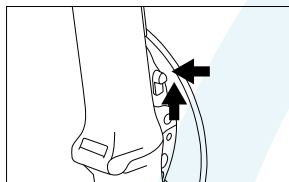

1. Push/slide the button up.

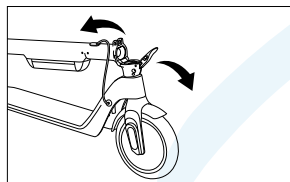

2. Pull the clip firmly away from the stem, while pushing the stem down.

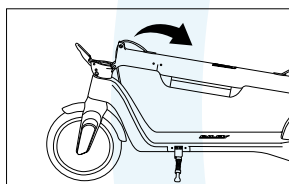

3. Fold the stem towards the rear fender.

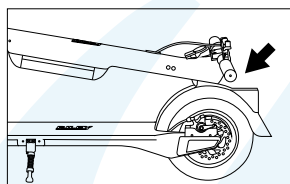

4. Align the hook with the fender clip on the rear fender and press down till it clicks.

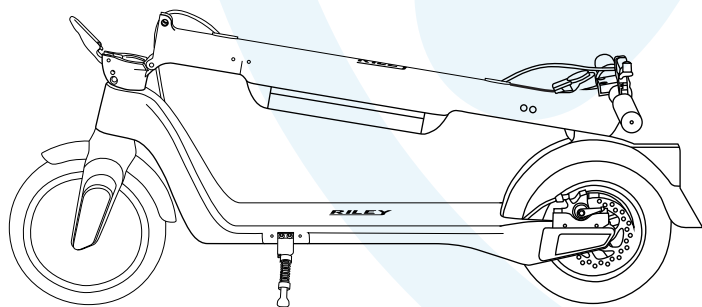

2.5 Uninstall/install the battery

Uninstall

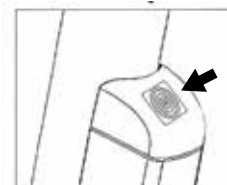

1. Push Battery clip in and hold.

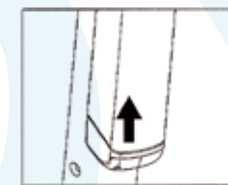

2. Push the battery up, away from the bottom of the stem.

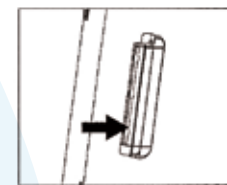

3. After pushing the battery up, pull it out horizontally.

Install

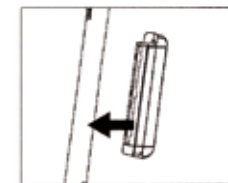

1. Insert the battery horizontally into the pole, while pushing the battery clip in.

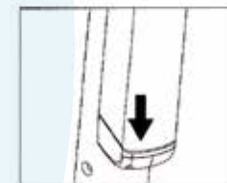

2. When in, let go of the battery clip, and push battery down until firmly secure.

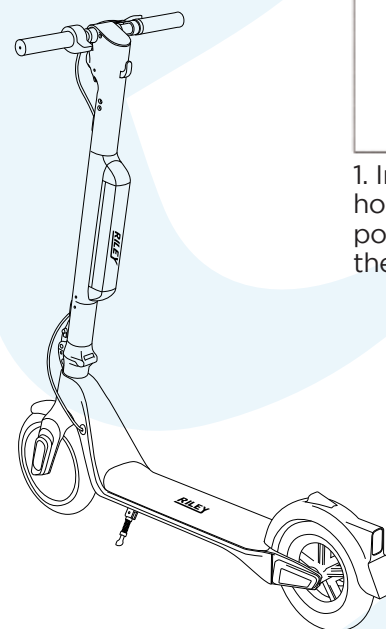

3. How to ride the e-scooter

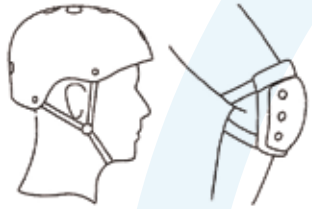

Wear a helmet, knee pads and elbow pads when you learn to ride the e-scooter.

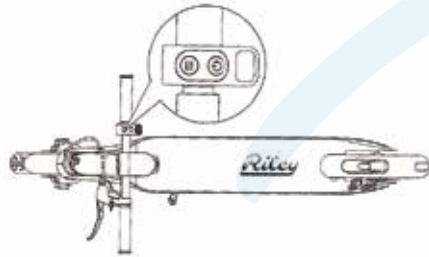

1. Press the POWER button for two seconds.



4. Press the THROTTLE slightly with your right hand to start and rotate the handlebars to turn.



5. Continuously press the throttle to speed up.



2. Put one foot on the base plate and push off the ground with your strong leg.



3. Balance both feet on your e-scooter when you have enough momentum.



6. Apply pressure to the brake handle to slow down or stop.



7. When the e-scooter stops or runs at a slow speed, you can get off.

4. Battery instruction

The instructions show you how to charge and maintain the battery and provide some safety notices and the technical specifications. Please use the battery properly according to these instructions to prolong battery life and performance.

4.1 Battery parameters

Name	Parameter
Type	Li-ion battery
Charging time	Approx. 4-5 hours
Voltage	36V
Working temperature	0°C - 35°C
Charging Temperature	0°C - 35°C
Max Charging Voltage	42V
Storage Time (at -10°C - 40°C)	3 months (full charge)
Initial Volume	8.7AH
Max Charging Current	2A

4.2 Battery safety

Do not disassemble the battery.

In the unlikely event that there is a leak in the battery or it overheats, do not use or charge it and contact us.

Do not let children touch the battery. Always unplug the charger before installing the battery or riding.

If you want the e-scooter to run most efficiently, the battery must be charged and used within the temperature range indicated in the battery parameters.

Lithium ion batteries are considered dangerous and require local law to allow transportation.

The battery contains dangerous substances. Please do not open the battery. Do not insert anything into the battery.

 Do not charge the battery at high temperature or charge the battery in a high temperature environment.

 Only use the original charging equipment to charge the e-scooter.

5. Specification

4.3 Charging instructions

Open the charging port cover, make sure the charging port is clean and dry.

Connect the charger to the battery and the plug to a power source (100V-240V;50/60Hz). Make sure the charging light is on.

When the charger indicator is green, charging is complete.

Charging method 1:

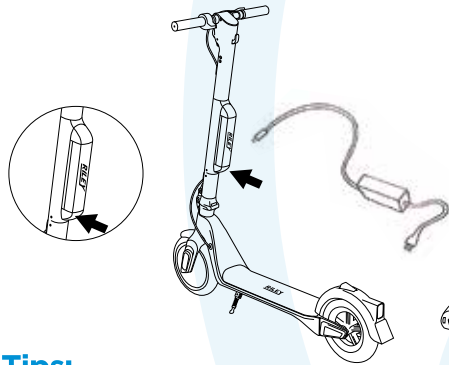

Charging method 2:

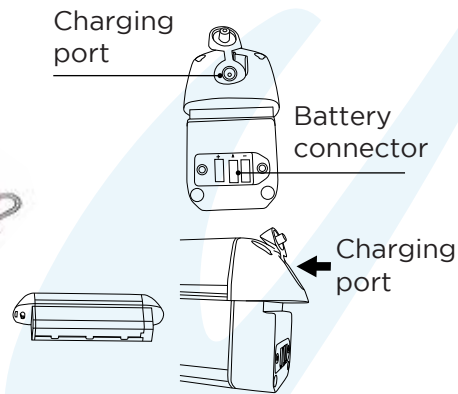

Tips:

Connect the charger to the AC power first, then connect it to the battery.

After charging, cover with the dustproof rubber to prevent anything from entering the charging port and causing battery failure.

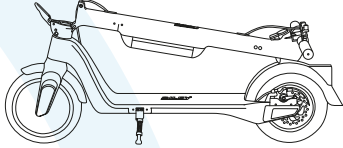
Product	
Scooter Specification	
Unfolded size	1131x450x1179mm
Folded size	1131x450x475mm
Height from baseplate to ground	115mm
Net weight	15.7kg
Tyre size	10 inch pneumatic air tyre with inner tube
Tyre pressure	35 P.S.I (2.41 Bar)
Waterproof level	IPX4
Basic Information	
Battery Capacity	36V/8.7AH
Motor power	350W
Mileage per charge	28 miles (45km)
Max speed	15.5 mph (25km/h)
Max loading	120kg
Climbing angle	15°
Driving modes	3 (beginner, eco, sport)
Charger Specification	
Input voltage	100-240Vac
Frequency	50-60Hz
Output voltage	42V
Output current	1.5A/2A
Store temperature	-10°C-35°C

6. Maintenance

Maintenance

Make sure the e-scooter charger and charging cord are disconnected and ensure that the e-scooter is off.

Wipe the shell with a soft cloth to clean the e-scooter.



Do not clean the e-scooter with a jet wash or by soaking in water. This will cause permanent damage.

Storage

Please charge your e-scooter before you store. Please ensure this is done at least once every three months.

If the storage temperature is lower than 0°C, please don't charge the e-scooter.

Please keep the e-scooter in a suitable place indoors, keep dry and at the appropriate temperature.



In order to protect the user's safety, do not take the e-scooter apart, otherwise the warranty of the product will be invalid.

7. Trouble shooting

Please contact us for a repair or if there are any issues with the e-scooter.

Tips:

Potential problem	Solution
Unable to start up	Check to see if the battery is charged.
Does not charge	<ol style="list-style-type: none">1. Check whether the plugboard has electricity.2. Check the charger to see whether the AC plug is connected (whether the light is on).3. Check the plug of the charger and the charging port of the e-scooter have been inserted correctly.

8. What's included

E-scooter packing list:

1x E-scooter

1x Battery

1x Charger

1x Manual

1x Set of screws and Allen key

1x Copy of Manufacturer's Limited Warranty

Please contact us if the product is broken or if anything is missing when you open the package. We will replace it for you as soon as possible.

9. Riley Scooter APP

Stay on the move with our app which connects directly to your scooter through Bluetooth. Get directions, view key riding info, and track your rides effortlessly.

Features:

- Cockpit showing key riding info
- Lock and trace your scooter
- Track your rides
- Shop our range of accessories

Note: When connecting to your scooter ensure your Bluetooth is enabled on your mobile device and the scooter is turned on.



Scan to download the App. Alternatively, go to the Google Play Store (Android) or the Apple App Store (iOS) and search Riley Scooters to download and install the App.

Be advised there is a minimum Android/iOS/Bluetooth version required. See user materials for additional details.

Download on the
App Store

GET IT ON
Google Play

FCC Statement

This equipment has been tested and found to comply with the limits for a Class B digital device, pursuant to part 15 of the FCC Rules. These limits are designed to provide reasonable protection against harmful interference in a residential installation. This equipment generates, uses and can radiate radio frequency energy and, if not installed and used in accordance with the instructions, may cause harmful interference to radio communications. However, there is no guarantee that interference will not occur in a particular installation. If this equipment does cause harmful interference to radio or

television reception, which can be determined by turning the equipment off and on, the user is encouraged to try to correct the interference by one or more of the following measures:

- Reorient or relocate the receiving antenna.
- Increase the separation between the equipment and receiver.
- Connect the equipment into an outlet on a circuit different from that to which the receiver is connected.
- Consult the dealer or an experienced radio/ TV technician for help.

This device complies with part 15 of the FCC Rules. Operation is subject to the following two conditions: (1) This device may not cause harmful interference, and (2) this device must accept any interference received, including interference that may cause undesired operation.

Caution

Any changes or modifications not expressly approved by the party responsible for compliance could void the user's authority to operate the equipment.

FCC Radiation Exposure Statement

The device has been evaluated to meet general RF exposure requirement. The device can be used in portable exposure condition without restriction

RILEY
SCOOTERS

