

# SAR TEST REPORT

<b>FCC ID</b> ..... :	2A9TN-H8	
<b>Test Report No</b> ..... :	TCT221220E917	
<b>Date of issue</b> ..... :	Dec. 28, 2022	
<b>Testing laboratory</b> .....	SHENZHEN TONGCE TESTING LAB	
<b>Testing location/ address:</b>	2101 & 2201, Zhenchang Factory Renshan Industrial Zone, Fuhai Subdistrict, Bao'an District, Shenzhen, Guangdong, 518103, People's Republic of China	
<b>Applicant's name</b> ..... :	Guangzhou Situoli Surveying and Mapping Technology Co., Ltd.	
<b>Address</b> ..... :	Room 601, Building C, No. 7, Caipin Road, Luogang Science City, Huangpu District Guangzhou Guangdong Province 510663, China	
<b>Manufacturer's name</b> ... :	Guangzhou Situoli Surveying and Mapping Technology Co., Ltd.	
<b>Address</b> ..... :	Room 601, Building C, No. 7, Caipin Road, Luogang Science City, Huangpu District Guangzhou Guangdong Province 510663, China	
<b>Test item description</b> .....	Handheld Laser Scanner	
<b>Trade Mark</b> .....	Stonex/思拓力	
<b>Model/Type reference</b> ..... :	H8	
<b>SAR Max. Values</b> ..... :	0.47 W/Kg (1g) for Body-worn	
<b>Date of receipt of test item</b> .....	Dec. 20, 2022	
<b>Date (s) of performance of test</b> ..... :	Mar. 03, 2022 ~ Dec. 28, 2022	
<b>Tested by (+signature)</b> ... :	Una Li	<i>Una Li</i>
<b>Check by (+signature)</b> .... :	Beryl Zhao	<i>Beryl Zhao</i>
<b>Approved by (+signature)</b> :	Tomsin	<i>Tomsin</i>



**General disclaimer:**

This report shall not be reproduced except in full, without the written approval of SHENZHEN TONGCE TESTING LAB. This document may be altered or revised by SHENZHEN TONGCE TESTING LAB personnel only, and shall be noted in the revision section of the document. The test results in the report only apply to the tested sample.

**TABLE OF CONTENTS**

1.	General Product Information .....	3
1.1.	EUT description.....	3
1.2.	Model(s) list .....	3
2.	Test standard .....	4
2.1.	Facilities and Accreditations.....	4
2.2.	Location .....	4
2.3.	Environment Condition: .....	4
3.	Test Result Summary .....	5
4.	RF Exposure Limit.....	6
5.	SAR Measurement System Configuration.....	7
5.1.	SAR Measurement Set-up .....	7
5.2.	E-field Probe.....	8
5.3.	Phantom.....	8
5.4.	Device Holder .....	9
5.5.	Data Storage and Evaluation.....	10
5.6.	Position of the wireless device in relation to the phantom .....	11
5.7.	Tissue Dielectric Parameters .....	14
5.8.	Tissue-equivalent Liquid Properties .....	15
5.9.	System Check.....	16
6.	Measurement Procedure .....	17
7.	Conducted Output Power .....	20
8.	Exposure Position Consideration .....	21
8.1.	EUT Antenna Location.....	21
8.2.	Test Position Consideration.....	22
9.	SAR Test Results Summary .....	23
9.1.	Body-Worn 1g SAR Data .....	23
9.2.	Simultaneous Transmission Conclusion .....	24
9.3.	SAR Simultaneous Transmission Analysis .....	25
9.4.	Measurement Uncertainty (450MHz-3GHz) .....	26
9.5.	Test Equipment List.....	28
10.	System Check Results .....	29
11.	SAR Test Data.....	31
	Appendix A: EUT Photos.....	43
	Appendix B: Test Setup Photos.....	45
	Appendix C: Probe Calibration Certificate.....	47
	Appendix D: Dipole Calibration Report .....	65
	Appendix E: SAR SYSTEM VALIDATION .....	77
	Appendix F: The Check Data of Impedance and Return Loss .....	78

## 1. General Product Information

### 1.1. EUT description

Test item description.....:	Handheld Laser Scanner
Model/Type reference.....:	H8
Sample Number.....:	TCT220303E018-0101
Rating(s).....:	Rechargeable Li-ion Battery DC 22.8V
<b>Wi-Fi 2.4G-0</b>	
Supported type.....:	802.11b/802.11g/802.11n
Modulation Type.....:	802.11b: DSSS; 802.11g/802.11n:OFDM
Operation Frequency.....:	802.11b/802.11g/802.11n(HT20):2412MHz~2462MHz; 802.11n(HT40):2422MHz~2452MHz
Channel number.....:	802.11b/802.11g/802.11n(HT20):11; 802.11n(HT40):7
Channel separation.....:	5MHz
<b>Wi-Fi 2.4G-1</b>	
Supported type.....:	802.11b/802.11g/802.11n
Modulation Type.....:	802.11b: DSSS; 802.11g/802.11n:OFDM
Operation Frequency.....:	802.11b/802.11g/802.11n(HT20):2412MHz~2462MHz; 802.11n(HT40):2422MHz~2452MHz
Channel number.....:	802.11b/802.11g/802.11n(HT20):11; 802.11n(HT40):7
Channel separation.....:	5MHz

### 1.2. Model(s) list

None

## 2. Test standard

The tests were performed according to following standards:

FCC 47 CFR §2.1093

BS IEC-IEEE 62209-1528-2020: Measurement procedure for the assessment of specific absorption rate of human exposure to radio frequency fields from hand-held and body-mounted wireless communication devices

KDB447498 D01:General RF Exposure Guidance v06

KDB865664 D01:SAR measurement 100MHz to 6GHz v01r04

KDB865664 D02:RF Exposure Reporting v01r02.

KDB248227 D01:802.11 wi-fi SAR v02r02

KDB941225 D07:UMPC Mini Tablet v01r02

KDB690783 D01:SAR Listings on Grant v01r03

### 2.1. Facilities and Accreditations

The test facility is recognized, certified, or accredited by the following organizations:

- FCC - Registration No.: 645098

SHENZHEN TONGCE TESTING LAB

Designation Number: CN1205

The testing lab has been registered and fully described in a report with the (FCC) Federal Communications Commission. The acceptance letter from the FCC is maintained in our files.

- IC - Registration No.: 10668A-1

SHENZHEN TONGCE TESTING LAB

CAB identifier: CN0031

The testing lab has been registered by Certification and Engineering Bureau of Industry Canada for radio equipment testing.

### 2.2. Location

SHENZHEN TONGCE TESTING LAB.

Address: 2101 & 2201, Zhenchang Factory Renshan Industrial Zone, Fuhai Subdistrict, Bao'an District, Shenzhen, Guangdong, 518103, People's Republic of China

### 2.3. Environment Condition:

Temperature:	18°C ~25°C
Humidity:	35%~75% RH
Atmospheric Pressure:	1011 mbar

### 3. Test Result Summary

The maximum results of Specific Absorption Rate (SAR) found during test as bellows:  
<Highest Reported standalone SAR Summary>

Exposure Position	Frequency Band	Reported SAR (W/kg)	Equipment Class	Highest Reported SAR (W/kg)
Body-worn 1-g SAR (0 mm Gap)	WLAN 2.4 GHz	<b>0.47</b>	DTS	<b>0.47</b>

<Highest Reported simultaneous SAR Summary>

Exposure Position	Frequency Band	Highest Reported Simultaneous Transmission SAR (W/kg)
Body 1-g SAR (0 mm Gap)	WIFI2.4G-0 + WIFI2.4G-1	0.87

**Note:**

1. The highest simultaneous transmission is scalar summation of Reported standalone SAR per FCC KDB 690783 D01 v01r03, and scalar SAR summation of all possible simultaneous transmission scenarios are < 1.6W/kg.
2. This device is compliance with Specific Absorption Rate (SAR) for general population/uncontrolled exposure limits specified in FCC 47 CFR part 2 (2.1093) and ANSI/IEEE C95.1-2005, and had been tested in accordance with the measurement methods and procedures specified in IEEE 1528-2013.
3. This test report was based on FCC ID: Y44-XH120; Only change applicant, address, product model No. and trade mark.

#### 4. RF Exposure Limit

Type Exposure	SAR (W/kg)
	Uncontrolled Exposure Limit
Spatial Peak SAR (averaged over any 1 g of tissue)	1.60
Spatial Peak SAR (hands/wrists/feet/ankles averaged over 10g)	4.00
Spatial Peak SAR (averaged over the whole body)	0.08

**Note:**

1. The Spatial Peak value of the SAR averaged over any 1 gram of tissue (defined as a tissue volume in the shape of a cube) and over the appropriate averaging time.
2. The Spatial Average value of the SAR averaged over the whole body.
3. The Spatial Peak value of the SAR averaged over any 10 grams of tissue (defined as a tissue volume in the shape of a cube) and over the appropriate averaging time.

## 5. SAR Measurement System Configuration

### 5.1. SAR Measurement Set-up

The OPENSAR system for performing compliance tests consist of the following items:

A standard high precision 6-axis robot (KUKA) with controller and software.

KUKA Control Panel (KCP)

A dosimetric probe, i.e., an isotropic E-field probe optimized and calibrated for usage in tissue simulating liquid. The probe is equipped with a Video Positioning System (VPS).

The stress sensor is composed with mechanical and electronic when the electronic part detects a change on the electro-mechanical switch; it sends an "Emergency signal" to the robot controller that to stop robot's moves A computer operating Windows XP.

OPENSAR software Remote control with teaches pendant and additional circuitry for robot safety such as warning lamps, etc.

The SAM phantom enabling testing left-hand right-hand and body usage.

The Position device for handheld EUT

Tissue simulating liquid mixed according to the given recipes.

System validation dipoles to validate the proper functioning of the system.

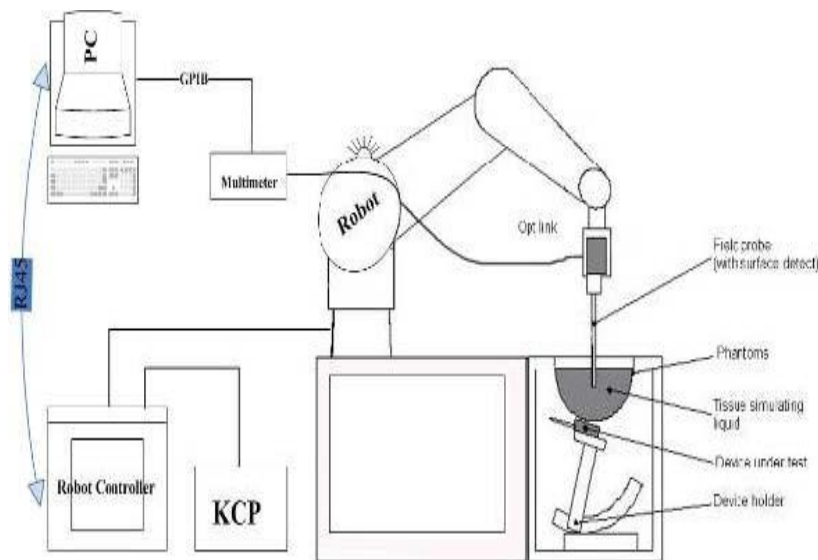

**KUKA SAR Test System Configuration**

## 5.2. E-field Probe

The SAR measurement is conducted with the dosimetric probe (manufactured by MVG). The probe is specially designed and calibrated for use in liquid with high permittivity. The dosimetric probe has special calibration in liquid at different frequency. This probe has a built in optical surface detection system to prevent from collision with phantom.

### Probe Specification

Construction Symmetrical design with triangular core  
Interleaved sensors  
Built-in shielding against static charges  
PEEK enclosure material (resistant to organic solvents, e.g., DGBE)  
Calibration ISO/IEC 17025 calibration service available.

Device Type	COMOSAR DOSIMETRIC E FIELD PROBE
Manufacturer	MVG
Model	SSE2
Serial Number	SN 25/22 EPGO375
Frequency Range of Probe	0.15 GHz-6GHz
Resistance of Three Dipoles at Connector	Dipole 1:R1=0.197MΩ Dipole 2:R3=0.230MΩ Dipole 3:R3=0.208MΩ

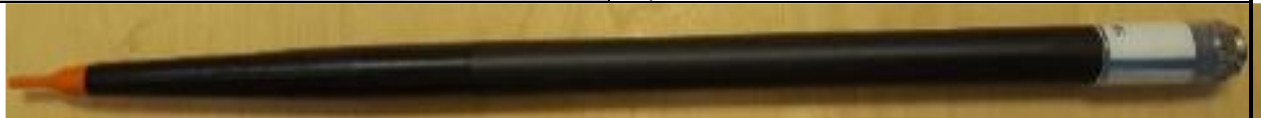

Photo of E-Field Probe

## 5.3. Phantom

The SAM Phantom SAM120 is constructed of a fiberglass shell integrated in a wooden table. The shape of the shell is in compliance with the specification set in IEEE P1528 and CENELEC BS IEC-IEEE 62209-1528-2020.

The phantom enables the dosimetric evaluation of left and right hand phone usage as well as body mounted usage at the flat phantom region.

A cover prevents the evaporation of the liquid.

Reference markings on the Phantom allow the complete setup of all predefined phantom positions and measurement grids by manually teaching three points in the robot

System checking was performed using the flat section, whilst Head SAR tests used the left and right head profile sections.

Body SAR testing also used the flat section between the head profiles.

Name: COMOSAR IEEE SAM PHANTOM

S/N: SN 19/15 SAM 120

Manufacture: MVG





SAM Twin Phantom

#### 5.4. Device Holder

In combination with the Generic Twin Phantom SAM120, the Mounting Device enables the rotation of the mounted transmitter in spherical coordinates whereby the rotation points is the ear opening. The devices can be easily, accurately, and repeatedly positioned according to the FCC and CENELEC specifications. The device holder can be locked at different phantom locations (left head, right head, flat phantom).

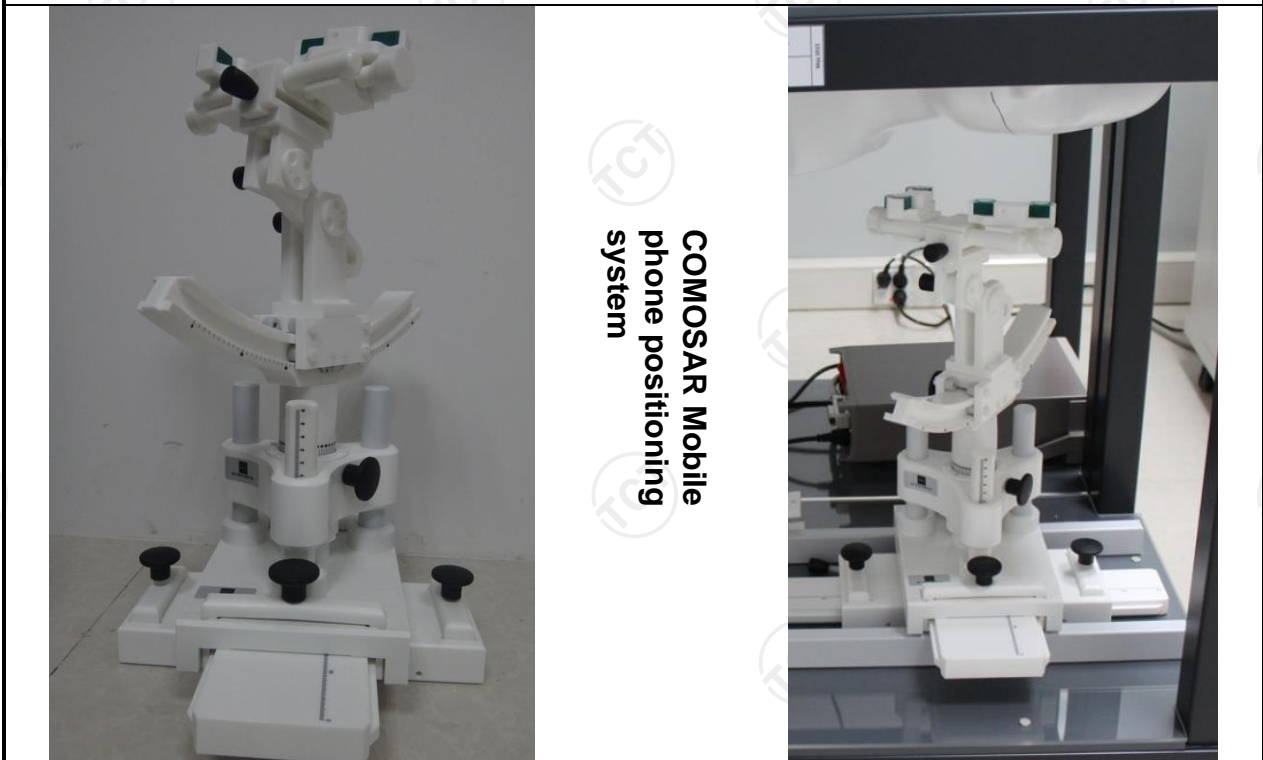

COMOSAR Mobile  
phone positioning  
system

## 5.5. Data Storage and Evaluation

### Data Storage

The OPENSAR software stores the acquired data from the data acquisition electronics as raw data (in microvolt readings from the probe sensors), together with all necessary software parameters for the data evaluation (probe calibration data, liquid parameters and device frequency and modulation data) in measurement files. The software evaluates the desired unit and format for output each time the data is visualized or exported. This allows verification of the complete software setup even after the measurement and allows correction of incorrect parameter settings. For example, if a measurement has been performed with a wrong crest factor parameter in the device setup, the parameter can be corrected afterwards and the data can be re-evaluated.

The measured data can be visualized or exported in different units or formats, depending on the selected probe type ([V/m], [A/m], [°C], [mW/g], [mW/cm<sup>2</sup>], [dBrel], etc.). Some of these units are not available in certain situations or show meaningless results, e.g., a SAR output in a lossless media will always be zero. Raw data can also be exported to perform the evaluation with other software packages.

### Data Evaluation

The OPENSAR software automatically executes the following procedures to calculate the field units from the microvolt readings at the probe connector. The parameters used in the evaluation are stored in the configuration modules of the software:

Probe parameters:	- Sensitivity	Normi, ai0, ai1, ai2
	- Conversion factor	ConvFi
	- Diode compression point	Dcpi
Device parameters:	- Frequency	f
	- Crest factor	cf
Media parameters:	- Conductivity	σ
	- Density	ρ

These parameters must be set correctly in the software. They can be found in the component documents or they can be imported into the software from the configuration files issued for the OPENSAR components. In the direct measuring mode of the millimeter option, the parameters of the actual system setup are used. In the scan visualization and export modes, the parameters stored in the corresponding document files are used.

The first step of the evaluation is a linearization of the filtered input signal to account for the compression characteristics of the detector diode. The compensation depends on the input signal, the diode type and the DC-transmission factor from the diode to the evaluation electronics. If the exciting field is pulsed, the crest factor of the signal must be known to correctly compensate for peak power. The formula for each channel can be given as:

$$V_i = U_i + U_i^2 \cdot c f / d c p_i$$

With	$V_i$	= compensated signal of channel i	(i = x, y, z)
	$U_i$	= input signal of channel i	(i = x, y, z)
	cf	= crest factor of exciting field	(MVG parameter)
	dcpi	= diode compression point	(MVG parameter)

From the compensated input signals the primary field data for each channel can be evaluated:

$$\text{E-field probes: } E_i = (V_i / \text{Normi} \cdot \text{ConvF})^{1/2}$$

$$\text{H-field probes: } H_i = (V_i)^{1/2} \cdot (a_{i0} + a_{i1} f + a_{i2} f^2) / f$$

With	$V_i$	= compensated signal of channel i	(i = x, y, z)
	Normi	= sensor sensitivity of channel i	(i = x, y, z)
		[mV/(V/m) <sup>2</sup> ] for E-field Probes	
	ConvF	= sensitivity enhancement in solution	
	a <sub>ij</sub>	= sensor sensitivity factors for H-field probes	
	f	= carrier frequency [GHz]	
	$E_i$	= electric field strength of channel i in V/m	
	$H_i$	= magnetic field strength of channel i in A/m	

The RSS value of the field components gives the total field strength (Hermitian magnitude):

$$E_{tot} = (E_x^2 + E_y^2 + E_z^2)^{1/2}$$

The primary field data are used to calculate the derived field units.

$$SAR = (E_{tot})^2 \cdot \sigma / (\rho \cdot 1000)$$

- with SAR = local specific absorption rate in mW/g
- E<sub>tot</sub> = total field strength in V/m
- σ = conductivity in [mho/m] or [Siemens/m]
- ρ = equivalent tissue density in g/cm<sup>3</sup>

Note that the density is normally set to 1 (or 1.06), to account for actual brain density rather than the density of the simulation liquid. The power flow density is calculated assuming the excitation field to be a free space field.

### 5.6. Position of the wireless device in relation to the phantom

#### Handset Reference Points

$$P_{pwe} = E_{tot}^2 / 3770 \text{ or } P_{pwe} = H_{tot}^2 \cdot 37.7$$

- With P<sub>pwe</sub> = equivalent power density of a plane wave in mW/cm<sup>2</sup>
- E<sub>tot</sub> = total electric field strength in V/m
- H<sub>tot</sub> = total magnetic field strength in A/m

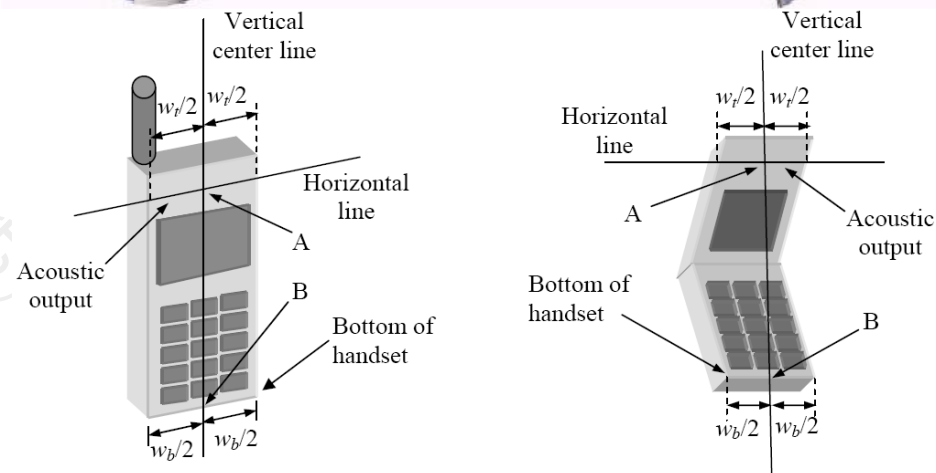

- W<sub>t</sub> Width of the handset at the level of the acoustic
- W<sub>b</sub> Width of the bottom of the handset
- A Midpoint of the width w<sub>t</sub> of the handset at the level of the acoustic output
- B Midpoint of the width w<sub>b</sub> of the bottom of the handset

#### Positioning for Cheek / Touch



**Positioning for Ear / 15° Tilt**

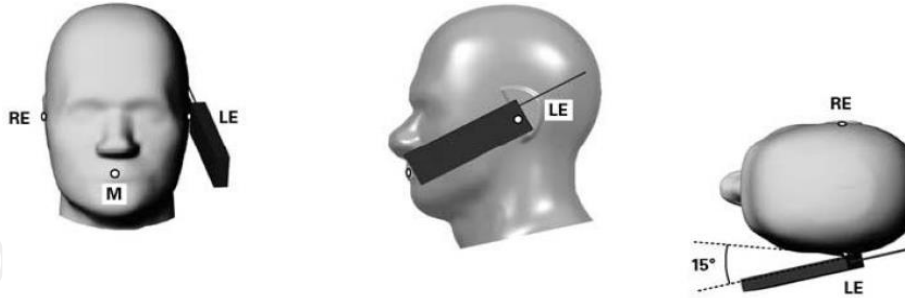

**Body Worn Accessory Configurations**

To position the device parallel to the phantom surface with either keypad up or down.

To adjust the device parallel to the flat phantom.

To adjust the distance between the device surface and the flat phantom to 15mm or holster surface and the flat phantom to 0 mm.

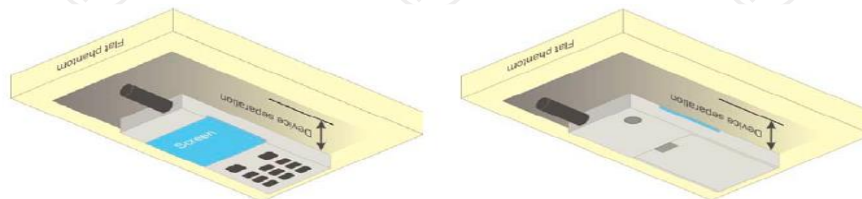

**Illustration for Body Worn Position**

**Wireless Router (Hotspot) Configurations**

Some battery-operated handsets have the capability to transmit and receive internet connectivity through simultaneous transmission of WIFI in conjunction with a separate licensed transmitter. The FCC has provided guidance in KDB Publication 941225 D06 where SAR test considerations for handsets (L x W ≥

9 cm x 5 cm) are based on a composite test separation distance of 10 mm from the front, back and edges of the device with antennas 2.5 cm or closer to the edge of the device, determined from general mixed use conditions for this type of devices. Since the hotspot SAR results may overlap with the body-worn accessory SAR requirements, the more conservative configurations can be considered, thus excluding some body-worn accessory SAR tests.

When the user enables the personal wireless router functions for the handset, actual operations include simultaneous transmission of both the WIFI transmitter and another licensed transmitter. Both transmitters often do not transmit at the same transmitting frequency and thus cannot be evaluated for SAR under actual use conditions. Therefore, SAR must be evaluated for each frequency transmission and mode separately and summed with the WIFI transmitter according to KDB 648474 publication procedures. The "Portable Hotspot" feature on the handset was NOT activated, to ensure the SAR measurements were evaluated for a single transmission frequency RF signal.

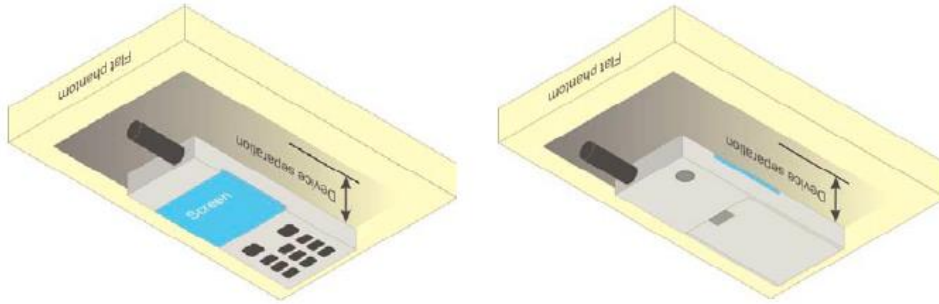
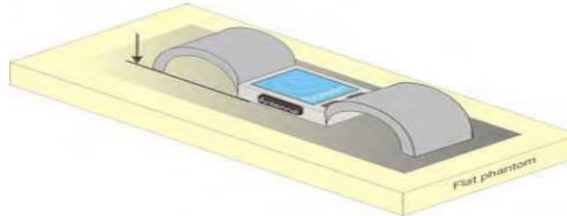

**Illustration for Hotspot Position**

**Limb-worn device**

A limb-worn device is a unit whose intended use includes being strapped to the arm or leg of the user while transmitting (except in idle mode). It is similar to a body-worn device. Therefore, the test positions of 6.1.4.4 also apply. The strap shall be opened so that it is divided into two parts as shown in Figure 9. The device shall be positioned directly against the phantom surface with the strap straightened as much as possible and the back of the device towards the phantom.

If the strap cannot normally be opened to allow placing in direct contact with the phantom surface, it may be necessary to break the strap of the device but ensuring to not damage the antenna.



**Test position for limb-worn devices**

## 5.7. Tissue Dielectric Parameters

The liquid used for the frequency range of 100MHz-6G consisted of water, sugar, salt and Cellulose. The liquid has been previously proven to be suited for worst-case. The following Table shows the detail solution. It's satisfying the latest tissue dielectric parameters requirements proposed by the IEEE 1528 and IEC 62209. The simulating liquids should be checked at the beginning of a series of SAR measurements to determine of the determine of the dielectric parameter are within the tolerances of the specified target values. The measured conductivity and relative permittivity should be within  $\pm 5\%$  of the target values.

The following materials are used for producing the tissue-equivalent materials

Targets for tissue simulating liquid

Frequency (MHz)	Liquid Type	Liquid Type ( $\sigma$ )	$\pm 5\%$ Range	Permittivity ( $\epsilon$ )	$\pm 5\%$ Range
300	Head	0.87	0.83~0.91	45.3	43.04~47.57
450	Head	0.87	0.83~0.91	43.5	41.33~45.68
835	Head	0.90	0.86~0.95	41.5	39.43~43.58
900	Head	0.97	0.92~1.02	41.	39.43~43.58
1800-2000	Head	1.40	1.33~1.47	40.0	38.00~42.00
2450	Head	1.80	1.71~1.89	39.2	37.24~41.16
2600	Head	1.96	1.86~2.06	39.0	37.05~40.95
3000	Head	2.40	2.28~2.52	38.5	36.58~40.43
5800	Head	5.27	5.01~5.53	35.3	33.54~37.07
300	Body	0.92	0.87~0.97	58.2	55.29~61.11
450	Body	0.94	0.89~0.99	56.7	53.87~59.54
835	Body	0.97	0.92~1.02	55.2	52.44~57.96
900	Body	1.05	1.00~1.10	55.0	52.25~57.75
1800-2000	Body	1.52	1.44~1.60	53.3	50.64~55.97
2450	Body	1.95	1.85~2.05	52.7	50.07~55.34
2600	Body	2.16	2.05~2.27	52.5	49.88~55.13
3000	Body	2.73	2.60~2.87	52.0	49.40~54.60
5800	Body	6.00	5.70~6.30	48.2	45.79~50.61

( $\epsilon_r$  = relative permittivity,  $\sigma$  = conductivity and  $\rho = 1000 \text{ kg/m}^3$ )

**5.8. Tissue-equivalent Liquid Properties**

Test Date dd/mm/yy	Temp °C	Tissue Type	Measured Frequency ( MHz )	$\epsilon_r$	$\sigma$ (s/m)	Dev $\epsilon_r$ (%)	Dev $\sigma$ (%)
08/11/2022	22°C	2450B	2422	54.63	1.98	3.66	1.54
			2455	54.62	2.01	3.64	3.08
			2480	54.59	2.03	3.59	4.10

### 5.9. System Check

The SAR system must be validated against its performance specifications before it is deployed. When SAR probe and system component or software are changed, upgraded or recalibrated, these must be validated with the SAR system(s) that operates with such component. Reference dipoles are used with the required tissue-equivalent media for system validation.

System check results have to be equal or near the values determined during dipole calibration with the relevant liquids and test system ( $\pm 10\%$ ).

System check is performed regularly on all frequency bands where tests are performed with the OPENSAR system.

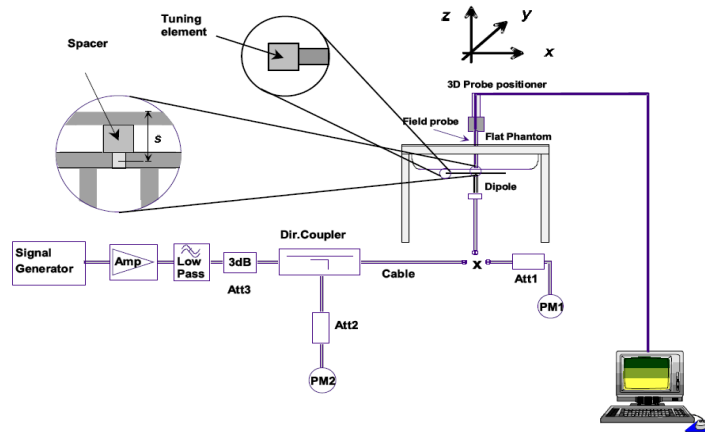

**System Check Set-up**

#### Verification Results

Frequency (MHz)	Liquid Type	Measured Value in 100mW (W/kg)		Normalized to 1W (W/kg)		Target Value (W/kg)		Deviation (%)	
		1 g Average	10 g Average	1 g Average	10 g Average	1 g Average	10 g Average	1 g Average	10 g Average
2450	Body	5.07	2.42	50.70	24.16	50.63	23.40	0.14	3.25

Comparing to the original SAR value provided by MVG, the verification data should be within its specification of 10%. Below table shows the target SAR and measured SAR after normalized to 1W input power. The table as below indicates the system performance check can meet the variation criterion and the plots can be referred to Section 10 of this report.



## 6. Measurement Procedure

### Conducted power measurement

For WWAN power measurement, use base station simulator to configure EUT WWAN transition in conducted connection with RF cable, at maximum power in each supported wireless interface and frequency band.

Read the WWAN RF power level from the base station simulator.

For WLAN/BT power measurement, use engineering software to configure EUT WLAN/BT continuously transmission, at maximum RF power in each supported wireless interface and frequency band.

Connect EUT RF port through RF cable to the power meter or spectrum analyser, and measure WLAN/BT output power.

### Conducted power measurement

Use base station simulator to configure EUT WWAN transmission in radiated connection, and engineering software to configure EUT WLAN/BT continuously transmission, at maximum RF power, in the highest power channel.

Place the EUT in positions as Appendix B demonstrates.

Set scan area, grid size and other setting on the MVG software.

Measure SAR results for the highest power channel on each testing position.

Find out the largest SAR result on these testing positions of each band.

Measure SAR results for other channels in worst SAR testing position if the Reported SAR or highest power channel is larger than 0.8 W/kg.

According to the test standard, the recommended procedure for assessing the peak spatial-average SAR value consists of the following steps:

Power reference measurement

Area scan

Zoom scan

Power drift measurement

### Spatial Peak SAR Evaluation

The procedure for spatial peak SAR evaluation has been implemented according to the test standard. It can be conducted for 1g and 10g, as well as for user-specific masses. The MVG software includes all numerical procedures necessary to evaluate the spatial peak SAR value.

The base for the evaluation is a "cube" measurement. The measured volume must include the 1g and 10g cubes with the highest averaged SAR values. For that purpose, the center of the measured volume is aligned to the interpolated peak SAR value of a previously performed area scan.

The entire evaluation of the spatial peak values is performed within the post-processing engine (SEMCAD). The system always gives the maximum values for 1g and 10g cubes. The algorithm to find the cube with highest averaged SAR is divided into the following stages:

Extraction of the measured data (grid and values) from the Zoom Scan.

Calculation of the SAR value at every measurement point based on all stored data (A/D values and measurement parameters).

Generation of a high-resolution mesh within the measured volume.

Interpolation of all measured values from the measurement grid to the high-resolution grid

Extrapolation of the entire 3-D field distribution to the phantom surface over the distance from sensor to surface

Calculation of the averaged SAR within masses of 1g and 10g.

### Power Reference Measurement

The Power Reference Measurement and Power Drift Measurement are for monitoring the power drift of the device under test in the batch process. The minimum distance of probe sensors to surface determines the closest measurement point to phantom surface. This distance cannot be smaller than the distance of sensor calibration points to probe tip as defined in the probe properties

### Area & Zoom Scan Procedures

First Area Scan is used to locate the approximate location(s) of the local peak SAR value(s). The measurement grid within an Area Scan is defined by the grid extent, grid step size and grid offset. Next, in order to determine the EM field distribution in a three-dimensional spatial extension, Zoom Scan is required. The Zoom Scan is performed around the highest E-field value to determine the averaged SAR-distribution over 10g. Area scan and zoom scan resolution setting follows KDB 865664 D01v01r03 quoted below.

		$\leq 3$ GHz	$> 3$ GHz	
Maximum distance from closest measurement point (geometric center of probe sensors) to phantom surface		5 mm $\pm$ 1 mm	$\frac{1}{2} \cdot \delta \cdot \ln(2)$ mm $\pm$ 0.5 mm	
Maximum probe angle from probe axis to phantom surface normal at the measurement location		30° $\pm$ 1°	20° $\pm$ 1°	
Maximum area scan spatial resolution: $\Delta x_{Area}$ , $\Delta y_{Area}$		$\leq 2$ GHz: $\leq 15$ mm 2 – 3 GHz: $\leq 12$ mm	3 – 4 GHz: $\leq 12$ mm 4 – 6 GHz: $\leq 10$ mm	
		When the x or y dimension of the test device, in the measurement plane orientation, is smaller than the above, the measurement resolution must be $\leq$ the corresponding x or y dimension of the test device with at least one measurement point on the test device.		
Maximum zoom scan spatial resolution: $\Delta x_{Zoom}$ , $\Delta y_{Zoom}$		$\leq 2$ GHz: $\leq 8$ mm 2 – 3 GHz: $\leq 5$ mm*	3 – 4 GHz: $\leq 5$ mm* 4 – 6 GHz: $\leq 4$ mm*	
Maximum zoom scan spatial resolution, normal to phantom surface	uniform grid: $\Delta z_{Zoom}(n)$	$\leq 5$ mm	3 – 4 GHz: $\leq 4$ mm 4 – 5 GHz: $\leq 3$ mm 5 – 6 GHz: $\leq 2$ mm	
	graded grid	$\Delta z_{Zoom}(1)$ : between 1 <sup>st</sup> two points closest to phantom surface	$\leq 4$ mm	3 – 4 GHz: $\leq 3$ mm 4 – 5 GHz: $\leq 2.5$ mm 5 – 6 GHz: $\leq 2$ mm
		$\Delta z_{Zoom}(n>1)$ : between subsequent points	$\leq 1.5 \cdot \Delta z_{Zoom}(n-1)$ mm	
Minimum zoom scan volume	x, y, z	$\geq 30$ mm	3 – 4 GHz: $\geq 28$ mm 4 – 5 GHz: $\geq 25$ mm 5 – 6 GHz: $\geq 22$ mm	
Note: $\delta$ is the penetration depth of a plane-wave at normal incidence to the tissue medium; see IEEE Std 1528-2013 for details.				
* When zoom scan is required and the <i>reported</i> SAR from the <i>area scan based 1-g SAR estimation</i> procedures of KDB Publication 447498 is $\leq 1.4$ W/kg, $\leq 8$ mm, $\leq 7$ mm and $\leq 5$ mm zoom scan resolution may be applied, respectively, for 2 GHz to 3 GHz, 3 GHz to 4 GHz and 4 GHz to 6 GHz.				

### Volume Scan Procedures

The volume scan is used for assess overlapping SAR distributions for antennas transmitting in different frequency bands. It is equivalent to an oversized zoom scan used in standalone measurements. The measurement volume will be used to enclose all the simultaneous transmitting antennas. For antennas transmitting simultaneously in different frequency bands, the volume scan is measured separately in each frequency band. In order to sum correctly to compute the 1g aggregate SAR, the EUT remain in the same test position for all measurements and all volume scan use the same spatial resolution and grid spacing. When all volume scan were completed, the software, SEMCAD post-processor scan combine and subsequently superpose these measurement data to calculating the multiband SAR.

**SAR Averaged Methods**

In MVG, the interpolation and extrapolation are both based on the modified Quadratic Shepard's method. The interpolation scheme combines a least-square fitted function method and a weighted average method which are the two basic types of computational interpolation and approximation.

Extrapolation routines are used to obtain SAR values between the lowest measurement points and the inner phantom surface. The extrapolation distance is determined by the surface detection distance and the probe sensor offset. The uncertainty increases with the extrapolation distance. To keep the uncertainty within 1% for the 1g and 10g cubes, the extrapolation distance should not be larger than 5 mm.

**Power Drift Monitoring**

All SAR testing is under the EUT install full charged battery and transmit maximum output power. In MVG measurement software, the power reference measurement and power drift measurement procedures are used for monitoring the power drift of EUT during SAR test. Both these procedures measure the field at a specified reference position before and after the SAR testing. The software will calculate the field difference in dB. If the power drifts more than 5%, the SAR will be retested.

**Power Drift measurement**

The drift job measures the field at the same location as the most recent reference job within the same procedure, and with the same settings. The drift measurement gives the field difference in dB from the reading conducted within the last reference measurement. Several drift measurements are possible for

**Measurement Uncertainty**

Per KDB 865664 D01 SAR Measurement 100KHz to 6GHz ,when the highest measurement 1-g SAR within a frequency band is  $<1.5\text{W/kg}$ , the extensive SAR measurement uncertainty analysis described IEEE Std 1528-2013 is not required in SAR report submitted for equipment approval.

## 7. Conducted Output Power

WLAN 2.4G-0						
Mode	802.11b			802.11g		
Channel	1	6	11	1	6	11
Frequency	2412	2437	2462	2412	2437	2462
Average Power (dBm)	16.49	16.52	<b>16.87</b>	14.57	14.18	14.23
Mode	802.11n(HT20)			802.11n(HT40)		
Channel	1	6	11	3	6	9
Frequency	2412	2437	2462	2422	2437	2452
Average Power (dBm)	14.35	14.24	14.36	13.72	13.31	13.45
WLAN 2.4G-1						
Mode	802.11b			802.11g		
Channel	1	6	11	1	6	11
Frequency	2412	2437	2462	2412	2437	2462
Average Power (dBm)	15.01	14.86	14.72	<b>15.17</b>	14.69	14.76
Mode	802.11n(HT20)			802.11n(HT40)		
Channel	1	6	11	3	6	9
Frequency	2412	2437	2462	2422	2437	2452
Average Power (dBm)	12.97	12.71	12.71	12.17	12.06	11.79
Total	802.11n(HT20)			802.11n(HT40)		
Channel	1	6	11	3	6	9
Frequency	2412	2437	2462	2422	2437	2452
Average Power (dBm)	16.72	16.55	<b>16.62</b>	16.02	15.74	15.71

### Note

1. Per KDB 248227 D01 v02r02, choose the highest output power channel to test SAR and determine further SAR exclusion.
2. The output power of all data rate were prescan , just the worst case (the lowest data rate) of all mode were shown in report

## 8. Exposure Position Consideration

### 8.1. EUT Antenna Location

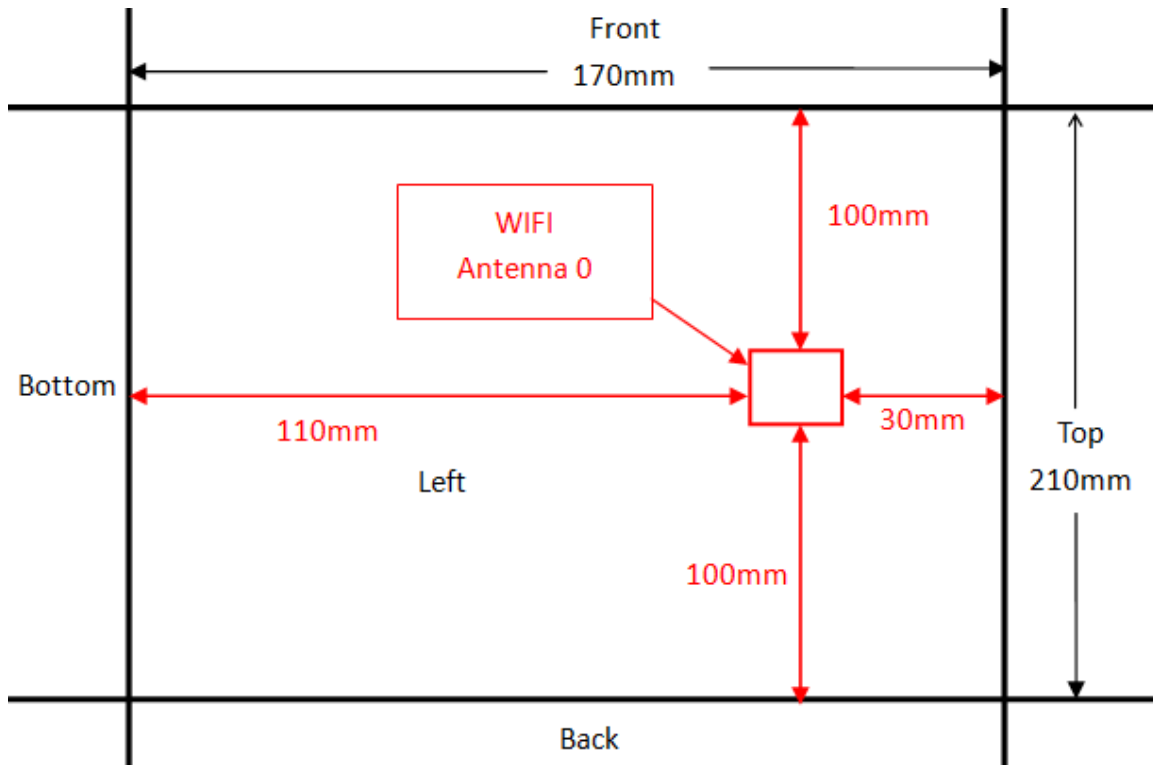

Antenna Configuration 1

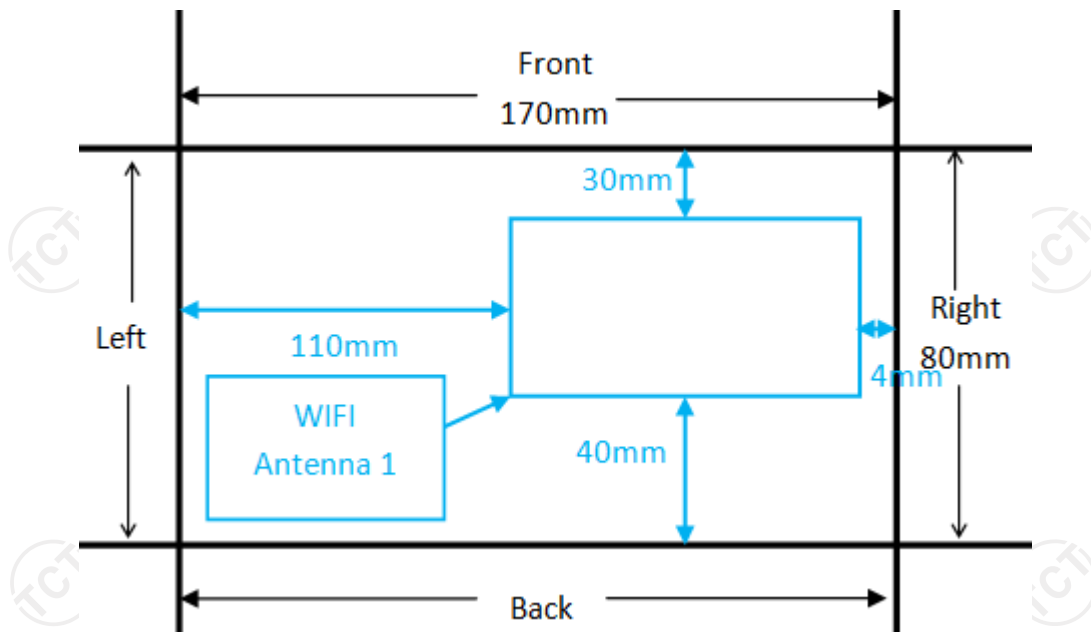

Antenna Configuration 2

## 8.2. Test Position Consideration

Test Positions						
Mode	Back	Front	Top Side	Bottom Side	Right Side	Left Side
WIFI	Yes	Yes	Yes	<b>NO</b>	Yes	Yes

**Note:**

1. KDB 447498 D01v06, particular DUT edges were not required to be evaluated for SAR if the antenna-to-edge distance is greater than 2.5cm..

## 9. SAR Test Results Summary

### 9.1. Body-Worn 1g SAR Data

Band	Mode	Test Position with 0mm	CH.	Freq. (MHz)	Ave. Power (dBm)	Tune-Up Limit (dBm)	Power Drift (%)	Meas. SAR1g (W/kg)	Scaling Factor	Reported SAR1g (W/kg)	Limit (W/Kg)
2.4G-0	802.11b	Left-level(external)	11	2462	16.87	17.00	1.00	0.43	1.030	<b>0.44</b>	1.60
		Left-vertical(external)	11	2462	16.87	17.00	-1.45	0.40	1.030	0.41	
		Left	11	2462	16.87	17.00	2.05	0.04	1.030	0.04	
2.4G-1	802.11b	Top	01	2412	15.17	15.50	0.92	0.37	1.079	<b>0.40</b>	
		Front	01	2412	15.17	15.50	-2.54	0.10	1.079	0.11	
		Back	01	2412	15.17	15.50	3.09	0.05	1.079	0.05	
		Right	01	2412	15.17	15.50	-2.52	0.02	1.079	0.02	
2.4G-01	802.11n	Left-level(external)	11	2462	16.62	17.00	2.95	0.30	1.091	0.33	
		Left-vertical(external)	11	2462	16.62	17.00	-2.64	0.40	1.091	0.44	
		Left	11	2462	16.62	17.00	2.85	0.08	1.091	0.09	
		Top	11	2462	16.62	17.00	-1.32	0.43	1.091	<b>0.47</b>	
		Front	11	2462	16.62	17.00	1.20	0.06	1.091	0.07	
		Back	11	2462	16.62	17.00	-2.03	0.03	1.091	0.03	
		Right	11	2462	16.62	17.00	1.05	0.02	1.091	0.02	

**Note:**

- Per KDB 447498 D01 v06, for each exposure position, if the highest output power channel Reported SAR  $\leq 0.8W/kg$ , other channels SAR testing is not necessary.
- Per KDB 447498 D01 v06, body-worn use is evaluated with the device positioned at 0 mm from a flat phantom filled with head tissue-equivalent medium.
- Per KDB 447498 D01 v06, the report SAR is measured SAR value adjusted for maximum tune-up tolerance. Scaling Factor =  $10^{[(\text{tune-up limit power (dBm)} - \text{Ave. power power (dBm)})/10]}$ , where tune-up limit is the maximum rated power among all production units.  
Reported SAR(W/kg) = Measured SAR (W/kg) \* Scaling Factor.
- Per KDB865664D01 v01r04 perform a second repeated measurement only the ratio of largest to smallest SAR for the original and first repeated measurement is  $>1.20$  or when the original or repeated measurement is  $\geq 1.45W/kg$ .
- Perform a second measurement only if the original, first and second repeated measurement is  $\geq 1.5w/kg$  and the ratio of largest to smallest SAR for the original, first and second repeated measurement is  $>1.20$ .

## 9.2. Simultaneous Transmission Conclusion

### Multi-Band Simultaneous Transmission Considerations

According to FCC KDB Publication 447498 D01v05r02, transmitters are considered to be transmitting simultaneously when there is overlapping transmission, with the exception of transmissions during network hand-offs with maximum hand-off duration less than 30 seconds. Possible transmission paths for the EUT are shown in below Figure and are color-coded to indicate communication modes which share the same path. Modes which share the same transmission path cannot transmit simultaneously with one another.



### Simultaneous Transmission Possibilities

The Simultaneous Transmission Possibilities of this device are as below:

NO.	Configuration	Head	Body-Worn	Hotspot
1	WIFI-0(2.4)+WIFI-1(2.4)	NO	YES	NO



### 9.3. SAR Simultaneous Transmission Analysis

Band	Test Position	Scaled SAR			Σ SAR (W/kg)	SPLSR	Remark
		WIFI-0 (2.4G)	WIFI-01 (2.4G)	WIFI-1 (2.4G)			
Body-Worn	Left-level(external)	0.44	0.33	/	0.77	N/A	N/A
	Left-vertical(external)	0.41	0.44	/	0.85	N/A	N/A
	Left	0.04	0.09	/	0.13	N/A	N/A
	Top	/	<b>0.47</b>	0.40	<b>0.87</b>	N/A	N/A
	Front	/	0.07	0.11	0.18	N/A	N/A
	Back	/	0.03	0.05	0.08	N/A	N/A
	Right	/	0.02	0.02	0.04	N/A	N/A

#### Simultaneous Transmission Conclusion

The above numerical summed SAR results for all the case simultaneous transmission conditions were below the SAR limit. Therefore, the above analysis is sufficient to determine that simultaneous transmission cases will not exceed the SAR limit and therefore measured volumetric simultaneous SAR summation is not required per FCC KDB Publication 447498 D01v05r02.

**9.4. Measurement Uncertainty (450MHz-3GHz)**

**UNCERTAINTY EVALUATION FOR HEADSET SAR**

Uncertainty Component	Description	Uncertainty Value(%)	Probably Distribution	Div.	(Ci) 1g	(Ci) 10g	Std. Unc. 1g(%)	Std. Unc. 10g(%)	v
<b>Measurement system</b>									
Probe calibration	7.2.1	5.8	N	1	1	1	5.8	5.8	∞
Axial isotropy	7.2.1.1	3.5	R	$\sqrt{3}$	$(1-C_p)^{1/2}$	$(1-C_p)^{1/2}$	1.43	1.43	∞
Hemispherical isotropy	7.2.1.1	5.9	R	$\sqrt{3}$	$\sqrt{C_p}$	$\sqrt{C_p}$	2.41	2.41	∞
Boundary Effects	7.2.1.4	1.00	R	$\sqrt{3}$	1	1	0.58	0.58	∞
Linearity	7.2.1.2	4.70	R	$\sqrt{3}$	1	1	2.71	2.71	∞
System detection limits	7.2.1.2	1	R	$\sqrt{3}$	1	1	0.58	0.58	∞
Modulation Response	7.2.1.3	3	N	1	1	1	3.00	3.00	∞
Readout Electronics	7.2.1.5	0.5	N	1	1	1	0.50	0.50	∞
Response Time	7.2.1.6	0	R	$\sqrt{3}$	1	1	0.00	0.00	∞
Integration Time	7.2.1.7	1.4	R	$\sqrt{3}$	1	1	0.81	0.81	∞
RF Ambient Conditions-Noise	7.2.3.7	3	R	$\sqrt{3}$	1	1	1.73	1.73	∞
RF Ambient Conditions-Reflection	7.2.3.7	3	R	$\sqrt{3}$	1	1	1.73	1.73	∞
Probe positioned mechanical Tolerance	7.2.2.1	1.4	R	$\sqrt{3}$	1	1	0.81	0.81	∞
Probe positioning with respect to phantom shell	7.2.2.3	1.4	R	$\sqrt{3}$	1	1	0.81	0.81	∞
Extrapolation interpolation and integration algorithms for Max.SAR evaluation	7.2.4	2.3	R	1	1	1	1.33	1.33	∞
<b>Test sample related</b>									
Test sample positioning	7.2.2.4.4	2.6	N	1	1	1	2.60	2.60	∞
Device holder uncertainty	7.2.2.4.2 7.2.2.4.3	3	N	1	1	1	3.00	3.00	∞
output power variation-SAR drift measurement	7.2.3.6	5	R	$\sqrt{3}$	1	1	2.89	2.89	∞
SAR scaling	7.2.5	2	R	$\sqrt{3}$	1	1	1.15	1.15	∞
<b>Phantom and tissue parameters</b>									
Phantom uncertainty (shape and thickness tolerances)	7.2.2.2	4	R	$\sqrt{3}$	1	1	2.31	2.31	∞
uncertainty in SAR correction for deviation (in permittivity and conductivity)	7.2.6	2	N	1	1	0.84	2.00	1.68	∞
Liquid conductivity (temperature uncertainty)	7.2.3.5	2.5	N	1	0.78	0.71	1.95	1.78	∞
Liquid conductivity -measurement uncertainty	7.2.3.3	4	N	1	0.23	0.26	0.92	1.04	∞
Liquid permittivity (temperature uncertainty)	7.2.3.5	2.5	N	1	0.78	0.71	1.95	1.78	∞
Liquid permittivity measurement uncertainty	7.2.3.4	5	N	1	0.23	0.26	1.15	1.30	∞
Combined standard uncertainty			RSS				10.83	10.54	
Expanded uncertainty (95%CONFIDENCEINTERVAL)			k				21.26	21.08	

**UNCERTAINTY FOR PERFORMANCE CHECK**

Uncertainty Component	Description	Uncertainty Value(%)	Probably Distribution	Div.	(Ci) 1g	(Ci) 10g	Std. Unc. 1g(%)	Std. Unc. 10g(%)	v
<b>Measurement system</b>									
Probe calibration	7.2.1	5.8	N	1	1	1	5.8	5.8	∞
Axial isotropy	7.2.1.1	3.5	R	$\sqrt{3}$	$(1-C_p)^{1/2}$	$(1-C_p)^{1/2}$	1.43	1.43	∞
Hemispherical isotropy	7.2.1.1	5.9	R	$\sqrt{3}$	$\sqrt{C_p}$	$\sqrt{C_p}$	2.41	2.41	∞
Boundary Effects	7.2.1.4	1.00	R	$\sqrt{3}$	1	1	0.58	0.58	∞
Linearity	7.2.1.2	4.70	R	$\sqrt{3}$	1	1	2.71	2.71	∞
System detection limits	7.2.1.2	1	R	$\sqrt{3}$	1	1	0.58	0.58	∞
Modulation Response	7.2.1.3	3	N	1	1	1	0.00	0.00	∞
Readout Electronics	7.2.1.5	0.5	N	1	1	1	0.50	0.50	∞
Response Time	7.2.1.6	0	R	$\sqrt{3}$	1	1	0.00	0.00	∞
Integration Time	7.2.1.7	1.4	R	$\sqrt{3}$	1	1	0.81	0.81	∞
RF Ambient Conditions-Noise	7.2.3.7	3	R	$\sqrt{3}$	1	1	1.73	1.73	∞
RF Ambient Conditions-Reflection	7.2.3.7	3	R	$\sqrt{3}$	1	1	1.73	1.73	∞
Probe positioned mechanical Tolerance	7.2.2.1	1.4	R	$\sqrt{3}$	1	1	0.81	0.81	∞
Probe positioning with respect to phantom shell	7.2.2.3	1.4	R	$\sqrt{3}$	1	1	0.81	0.81	∞
Extrapolation interpolation and integration algorithms for Max.SAR evaluation	7.2.4	2.3	R	1	1	1	1.33	1.33	∞
<b>Dipole</b>									
Deviation of experimental source from numerical source		4	N	1	1	1	4.00	4.00	∞
Input power and SAR drift measurement	7.2.3.6	5	R	$\sqrt{3}$	1	1	2.89	2.89	∞
Dipole axis to liquid distance		2	R	$\sqrt{3}$	1	1			∞
<b>Phantom and tissue parameters</b>									
Phantom uncertainty (shape and thickness tolerances)	7.2.2.2	4	R	$\sqrt{3}$	1	1	2.31	2.31	∞
uncertainty in SAR correction for deviation (in permittivity and conductivity)	7.2.6	2	N	1	1	0.84	2.00	1.68	∞
Liquid conductivity (temperature uncertainty)	7.2.3.5	2.5	N	1	0.78	0.71	1.95	1.78	∞
Liquid conductivity -measurement uncertainty	7.2.3.3	4	N	1	0.23	0.26	0.92	1.04	∞
Liquid permittivity (temperature uncertainty)	7.2.3.5	2.5	N	1	0.78	0.71	1.95	1.78	∞
Liquid permittivity measurement uncertainty	7.2.3.4	5	N	1	0.23	0.26	1.15	1.30	∞
Combined standard uncertainty			RSS				10.15	10.05	
Expanded uncertainty (95%CONFIDENCEINTERVAL)			k				20.29	20.10	

### 9.5. Test Equipment List

Test Equipment	Manufacturer	Model	Serial Number	Calibration	
				Calibration Date (D.M.Y)	Calibration Due (D.M.Y)
PC	Lenovo	H3050	N/A	N/A	N/A
Signal Generator	Angilent	N5182A	MY47070282	Jul. 04, 2022	Jul. 03, 2023
Multimeter	Keithley	Multimeter 2000	4078275	Jul. 04, 2022	Jul. 03, 2023
Network Analyzer	Agilent	8753E	US38432457	Jul. 04, 2022	Jul. 03, 2023
Wireless Communication Test Set	R & S	CMU200	111382	Jul. 04, 2022	Jul. 03, 2023
Wideband Radio Communication Tester	R&S	CMW500	114220	Jul. 04, 2022	Jul. 03, 2023
Power Meter	Agilent	E4418B	GB43312526	Jul. 04, 2022	Jul. 03, 2023
Power Meter	Agilent	E4416A	MY45101555	Jul. 04, 2022	Jul. 03, 2023
Power Meter	Agilent	N1912A	MY50001018	Jul. 04, 2022	Jul. 03, 2023
Power Sensor	Agilent	E9301A	MY41497725	Jul. 04, 2022	Jul. 03, 2023
Power Sensor	Agilent	E9327A	MY44421198	Jul. 04, 2022	Jul. 03, 2023
Power Sensor	Agilent	E9323A	MY53070005	Jul. 04, 2022	Jul. 03, 2023
Power Amplifier	PE	PE15A4019	112342	N/A	N/A
Directional Coupler	Agilent	722D	MY52180104	N/A	N/A
Attenuator	Chensheng	FF779	134251	N/A	N/A
E-Field PROBE	MVG	SSE2	SN 25/22 EPGO375	Jun. 29, 2022	Jun. 28, 2023
DIPOLE 2450	MVG	SID 2450	SN 16/15 DIP 2G450-374	Jun. 05, 2021	Jun. 04, 2024
Limesar Dielectric Probe	MVG	SCLMP	SN 19/15 OCPG71	Jun. 05, 2021	Jun. 04, 2024
Communication Antenna	MVG	ANTA59	SN 39/14 ANTA59	N/A	N/A
Mobile Phone Position Device	MVG	MSH101	SN 19/15 MSH101	N/A	N/A
Dummy Probe	MVG	DP66	SN 13/15 DP66	N/A	N/A
SAM PHANTOM	MVG	SAM120	SN 19/15 SAM120	N/A	N/A
PHANTOM TABLE	MVG	TABP101	SN 19/15 TABP101	N/A	N/A
Robot TABLE	MVG	TABP61	SN 19/15 TABP61	N/A	N/A
6 AXIS ROBOT	KUKA	KR6-R900	501822	N/A	N/A

**Note:** 1. N/A means this equipment no need to calibrate  
 2. Each Time means this device need to calibrate every use time  
 3. The dipole was not damaged properly repaired.  
 4. The measured SAR deviates from the calibrated SAR value by less than 10%  
 5. The most recent return-loss result meets the required 20 dB minimum return-loss requirement  
 6. The most recent measurement of the real or imaginary parts of the impedance deviates by less than 5 Ω from the previous measurement.

## 10. System Check Results

Date of measurement: 08/11/2022 Test mode: 2450MHz (Body)  
 Product Description: Validation  
 Dipole Model: SID2450  
 E-Field Probe: SSE2 (SN 25/22 EPGO375)

Phantom	Validation plane
Input Power	100mW
Crest Factor	1.0
Probe Conversion factor	4.70
Frequency (MHz)	2450.000000
Relative permittivity (real part)	54.616199
Relative permittivity (imaginary part)	14.930150
Conductivity (S/m)	2.012159
Variation (%)	-0.230000
<b>SAR 10g (W/Kg)</b>	<b>2.416669</b>
<b>SAR 1g (W/Kg)</b>	<b>5.066368</b>

### SURFACE SAR

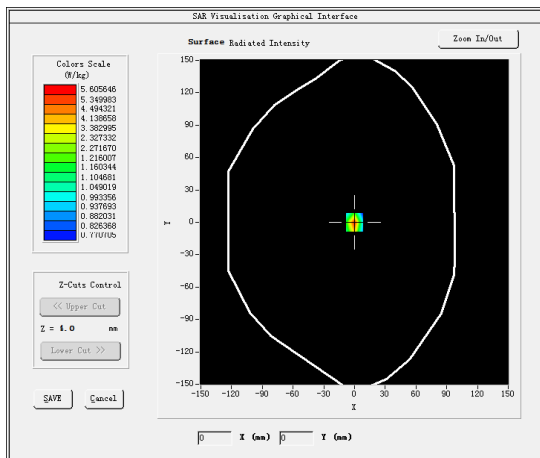

### VOLUME SAR

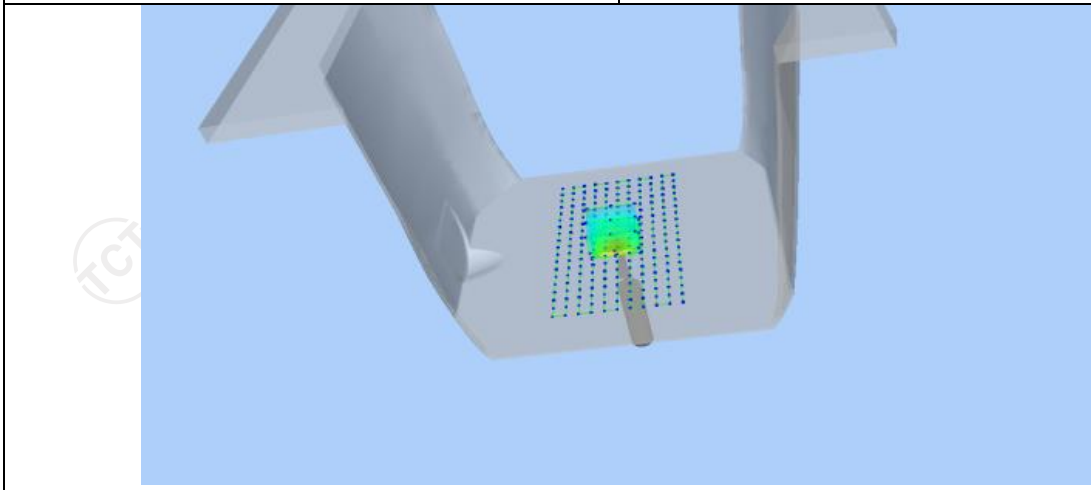
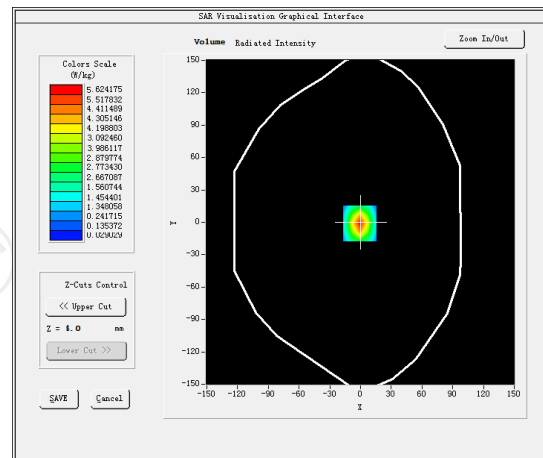

Z (mm)	0.00	4.00	9.00	14.00	19.00
SAR (W/Kg)	5.0622	2.7984	1.5251	0.8352	0.4200

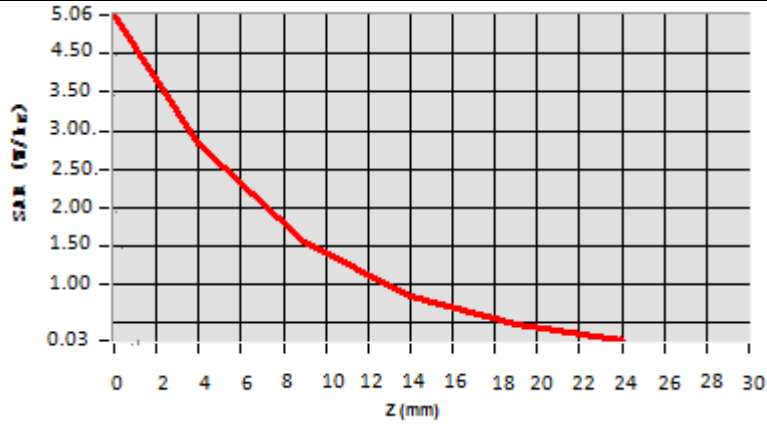

**Hot spot position**



**11. SAR Test Data**

2.4G -0

**MEASUREMENT 1**

Hight Band SAR (Channel 11):

Date: 08/11/2022

<b>Frequency (MHz)</b>	2462.000000
<b>Relative permittivity (real part)</b>	54.623847
<b>Relative permittivity (imaginary part)</b>	14.318478
<b>Conductivity (S/m)</b>	2.012374
<b>Variation (%)</b>	1.000000
<b>Crest Factor</b>	1.0
<b>Probe Conversion factor</b>	4.70
<b>E-Field Probe:</b>	SSE2 (SN 25/22 EPGO375)
<b>Area Scan</b>	<u>dx=8mm dy=8mm, h= 5.00 mm</u>
<b>ZoomScan</b>	<u>5x5x7, dx=8mm dy=8mm</u> <u>dz=5mm, Complete/ndx=8mm dy=8mm, h=</u> <u>5.00 mm</u>
<b>Phantom</b>	Validation plane
<b>Device Position</b>	Body Left-level(external) (0mm)
<b>Band</b>	<u>IEEE 802.11b ISM</u>

**SURFACE SAR**

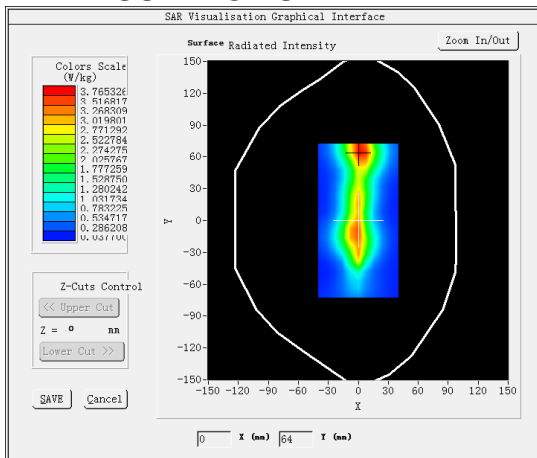

**VOLUME SAR**

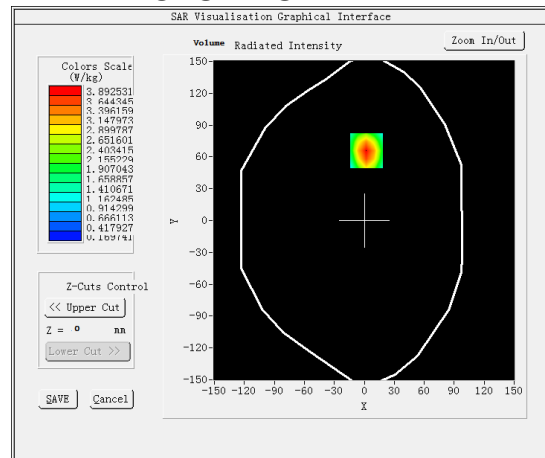

**Maximum location: X=-21.00, Y=10.00 SAR Peak: 1.10 W/kg**

**SAR 10g (W/Kg)**

0.252015

**SAR 1g (W/Kg)**

0.426122

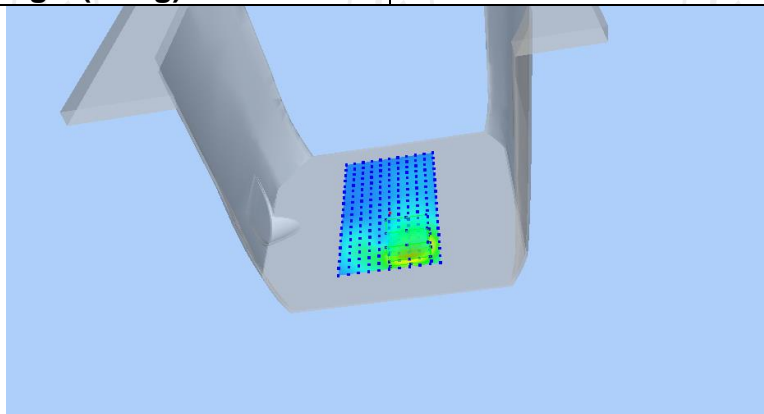

Z (mm)	0.00	4.00	9.00	14.00	19.00
SAR (W/Kg)	1.1020	0.5352	0.2104	0.0721	0.0218

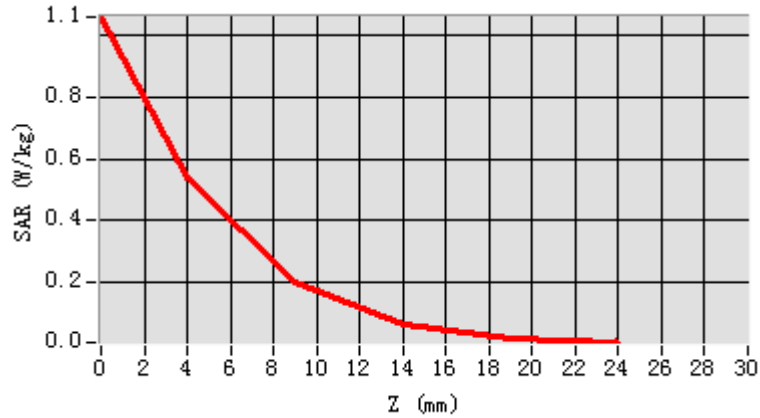

Hot spot position

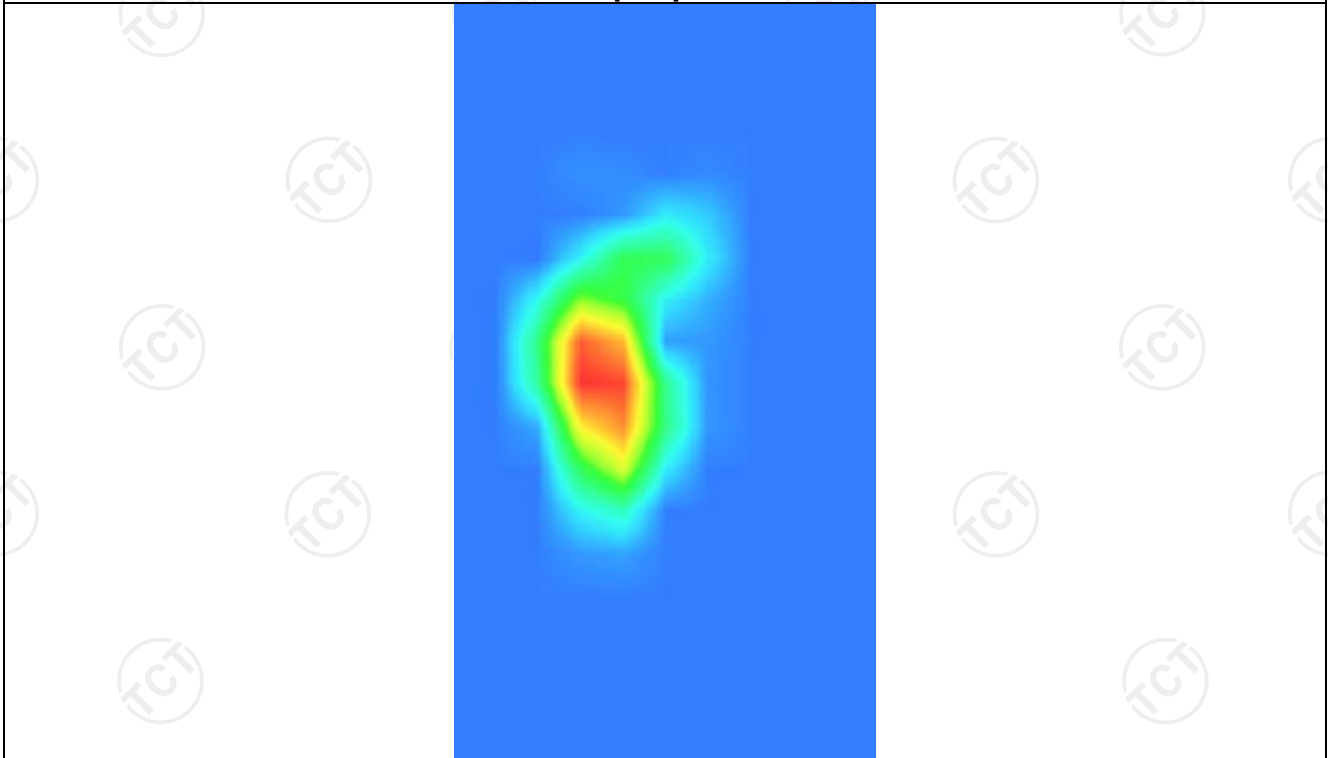



**MEASUREMENT 2**

Hight Band SAR (Channel 11):

Date: 08/11/2022

<b>Frequency (MHz)</b>	2462.000000
<b>Relative permittivity (real part)</b>	54.623847
<b>Relative permittivity (imaginary part)</b>	14.318478
<b>Conductivity (S/m)</b>	2.012374
<b>Variation (%)</b>	-1.450000
<b>Crest Factor</b>	1.0
<b>Probe Conversion factor</b>	4.70
<b>E-Field Probe:</b>	SSE2 (SN 25/22 EPGO375)
<b>Area Scan</b>	<u>dx=8mm dy=8mm, h= 5.00 mm</u>
<b>ZoomScan</b>	<u>5x5x7, dx=8mm dy=8mm</u> <u>dz=5mm, Complete/ndx=8mm dy=8mm, h=</u> <u>5.00 mm</u>
<b>Phantom</b>	Validation plane
<b>Device Position</b>	Body Left- vertical(external) (0mm)
<b>Band</b>	<u>IEEE 802.11b ISM</u>

**SURFACE SAR**

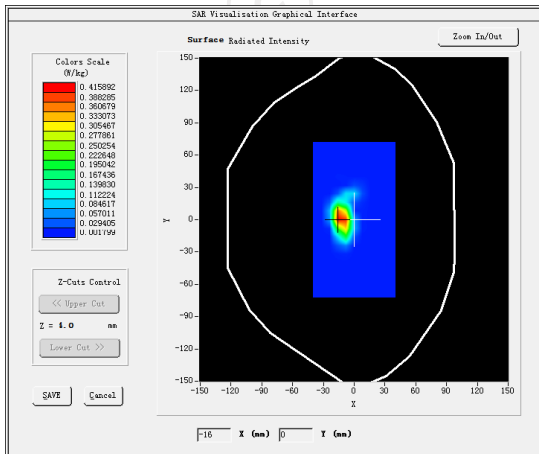

**VOLUME SAR**

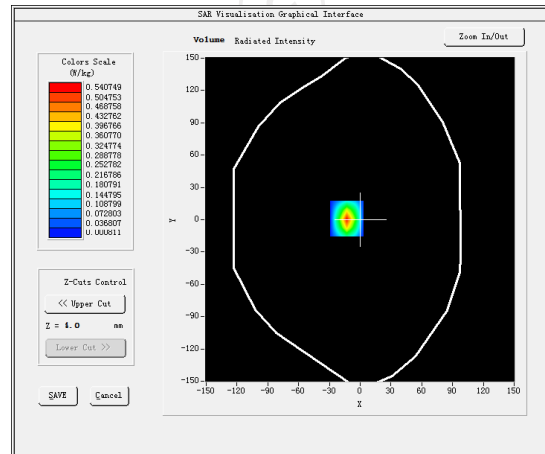

**Maximum location: X=-18.00, Y=12.00 SAR Peak: 1.10 W/kg**

**SAR 10g (W/Kg)**

0.264284

**SAR 1g (W/Kg)**

0.402437

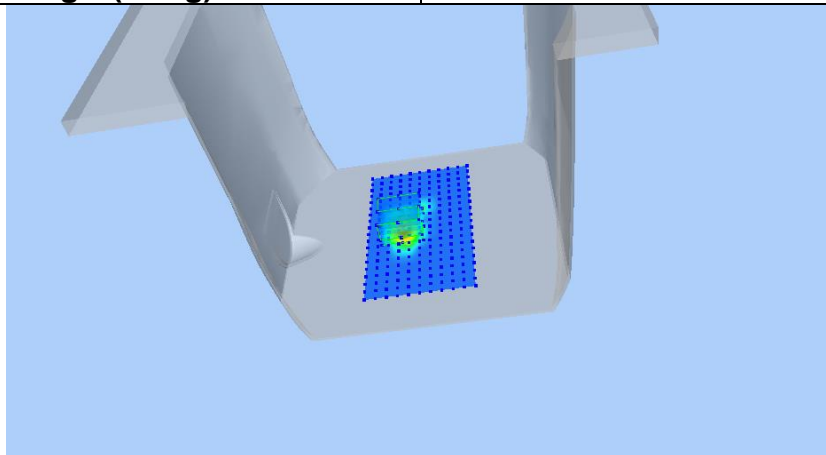

Z (mm)	0.00	4.00	9.00	14.00	19.00
SAR (W/Kg)	1.1043	0.5412	0.2056	0.0678	0.0226

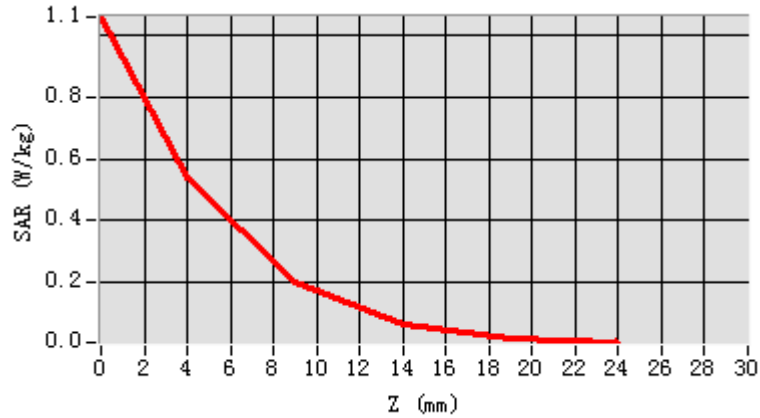

Hot spot position

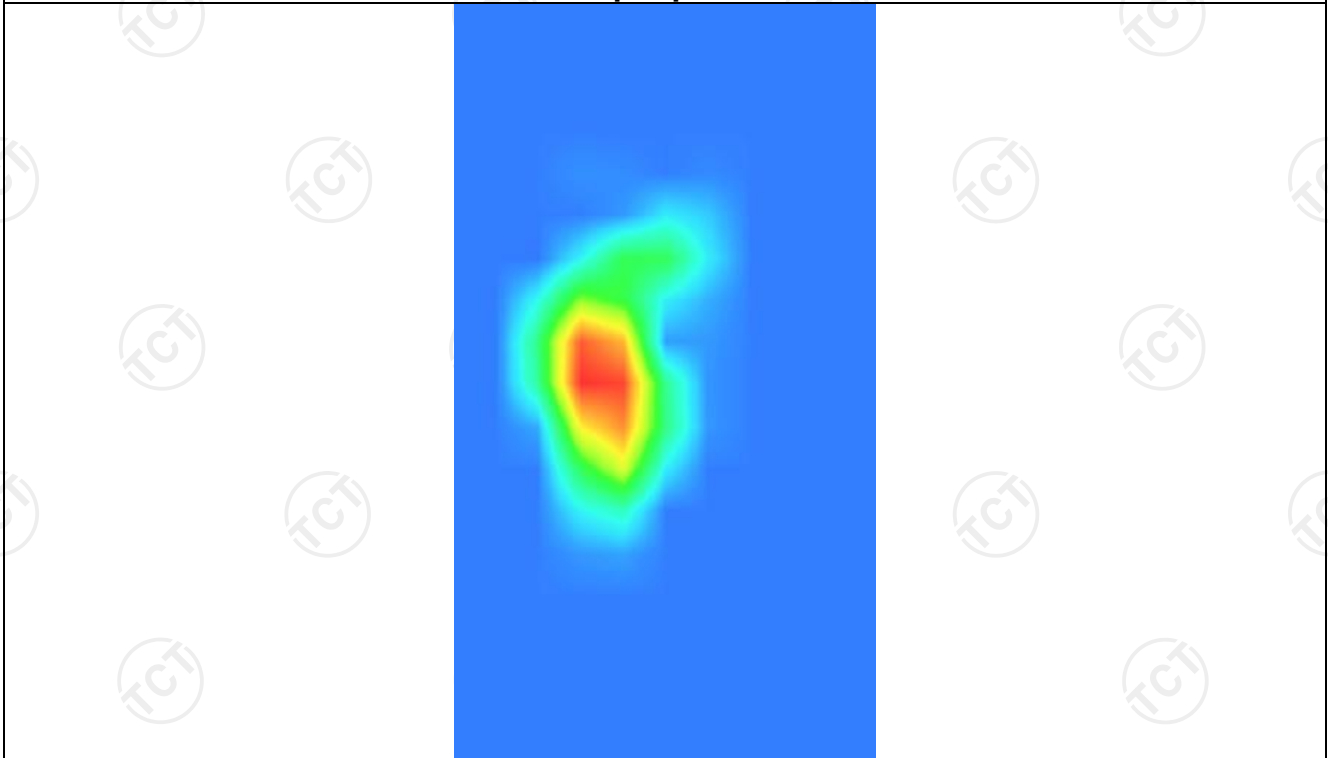

2.4G -1

**MEASUREMENT 1**

Lower Band SAR (Channel 01):

Date: 08/11/2022

<b>Frequency (MHz)</b>	2412.000000
<b>Relative permittivity (real part)</b>	54.630667
<b>Relative permittivity (imaginary part)</b>	14.318444
<b>Conductivity (S/m)</b>	1.982536
<b>Variation (%)</b>	0.920000
<b>Crest Factor</b>	1.0
<b>Probe Conversion factor</b>	4.70
<b>E-Field Probe:</b>	SSE2 (SN 25/22 EPGO375)
<b>Area Scan</b>	<u>dx=8mm dy=8mm, h= 5.00 mm</u>
<b>ZoomScan</b>	<u>5x5x7, dx=8mm dy=8mm</u> <u>dz=5mm, Complete/ndx=8mm dy=8mm, h=</u> <u>5.00 mm</u>
<b>Phantom</b>	Validation plane
<b>Device Position</b>	Body Top(0mm)
<b>Band</b>	<u>IEEE 802.11b ISM</u>

**SURFACE SAR**

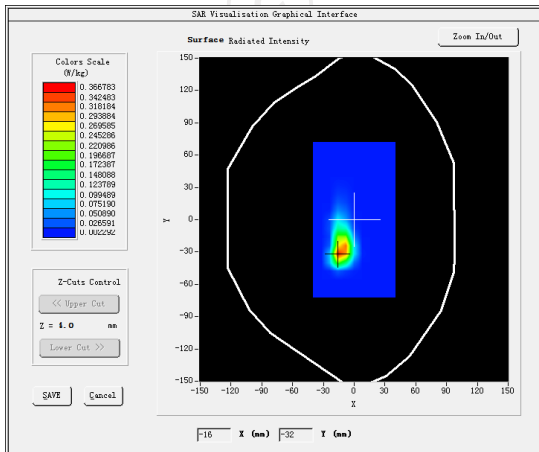

**VOLUME SAR**

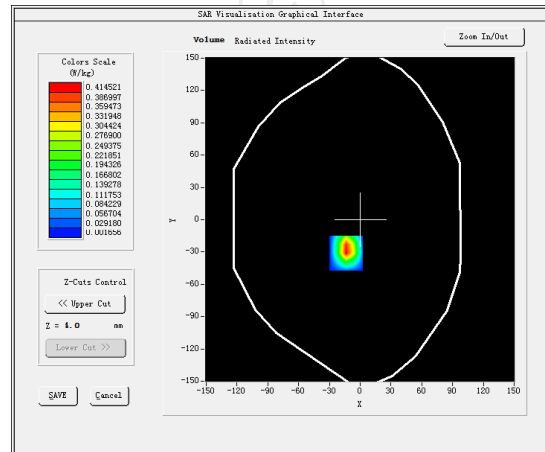

**Maximum location: X=-17.00, Y=-30.00 SAR Peak: 0.90 W/kg**

**SAR 10g (W/Kg)**

0.172432

**SAR 1g (W/Kg)**

0.374213

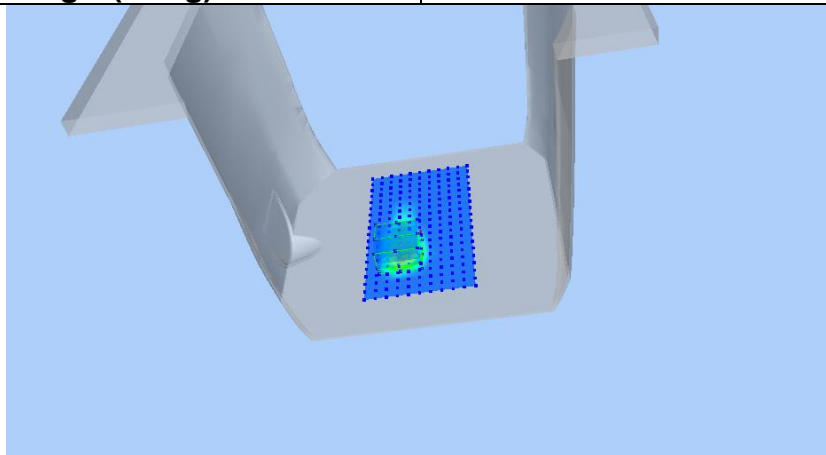

Z (mm)	0.00	4.00	9.00	14.00	19.00
SAR (W/Kg)	0.8978	0.4251	0.1372	0.0313	0.0081

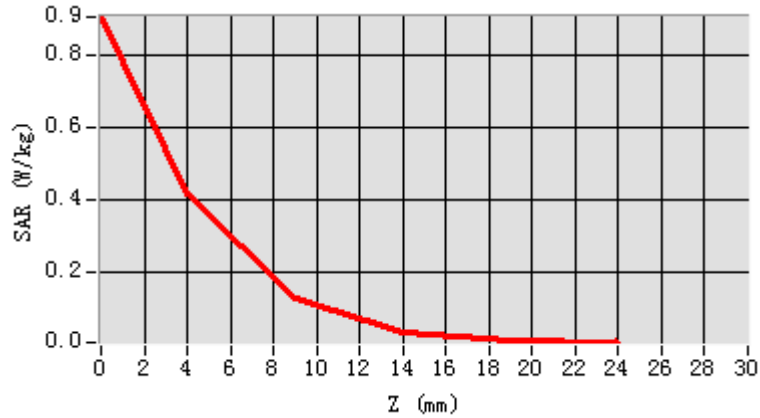

Hot spot position

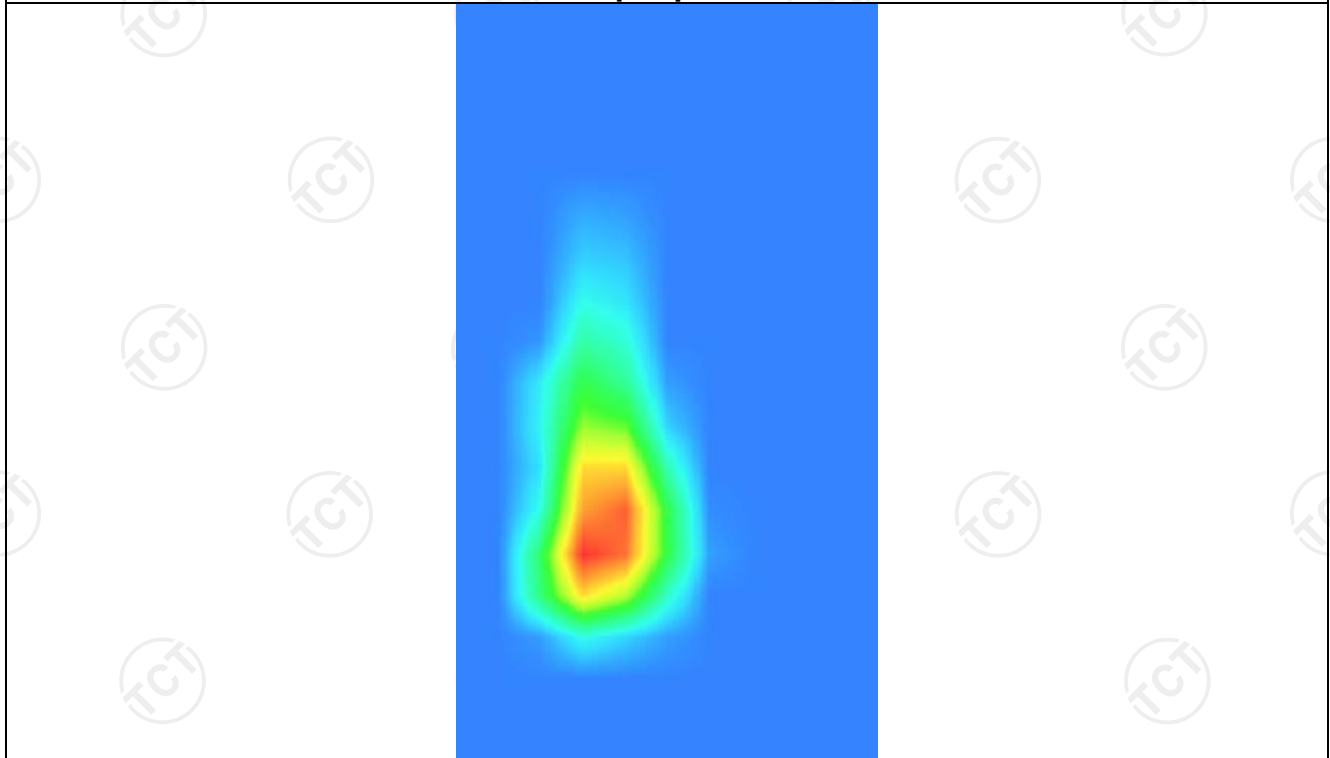

2.4G -0&1

**MEASUREMENT 1**

Hight Band SAR (Channel 11):

Date: 08/11/2022

<b>Frequency (MHz)</b>	2462.000000
<b>Relative permittivity (real part)</b>	54.623847
<b>Relative permittivity (imaginary part)</b>	14.318478
<b>Conductivity (S/m)</b>	2.012374
<b>Variation (%)</b>	2.950000
<b>Crest Factor</b>	1.0
<b>Probe Conversion factor</b>	4.70
<b>E-Field Probe:</b>	SSE2 (SN 25/22 EPGO375)
<b>Area Scan</b>	<u>dx=8mm dy=8mm, h= 5.00 mm</u>
<b>ZoomScan</b>	<u>5x5x7, dx=8mm dy=8mm</u> <u>dz=5mm, Complete/ndx=8mm dy=8mm, h=</u> <u>5.00 mm</u>
<b>Phantom</b>	Validation plane
<b>Device Position</b>	Body Left-level(external) (0mm)
<b>Band</b>	<u>IEEE 802.11n ISM</u>

**SURFACE SAR**

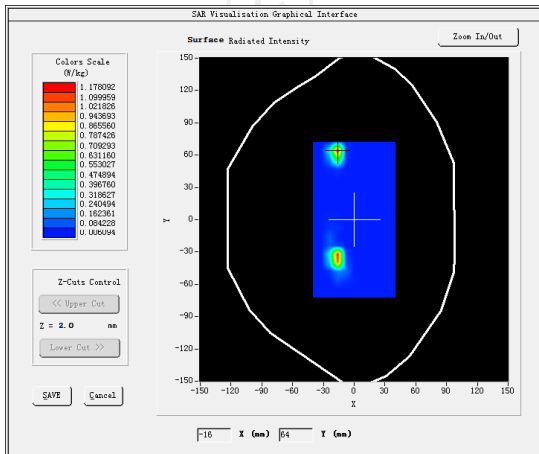

**VOLUME SAR**

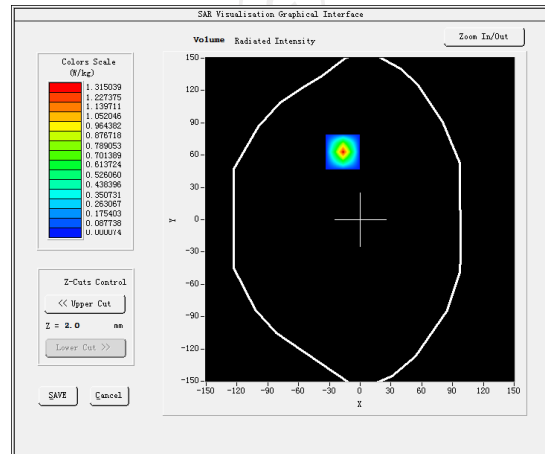

**Maximum location: X=-18.00, Y=17.00 SAR Peak: 2.30 W/kg**

**SAR 10g (W/Kg)**

0.254214

**SAR 1g (W/Kg)**

0.297016

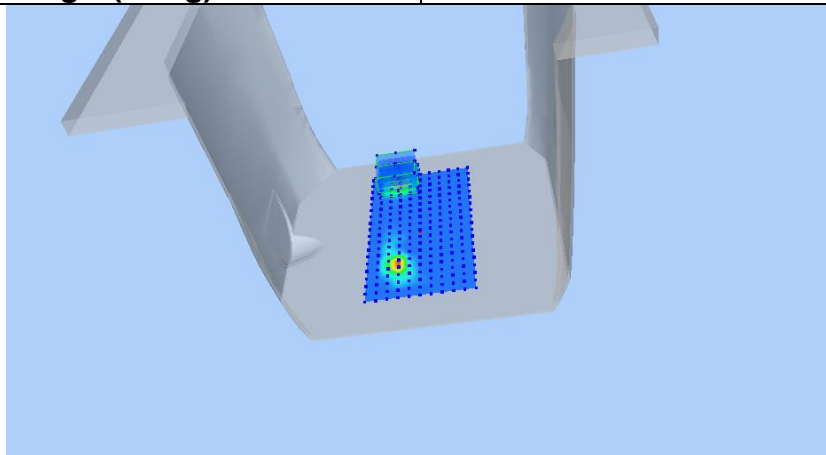

Z (mm)	0.00	2.00	7.00	12.00	17.00
SAR (W/Kg)	2.3021	1.3243	0.1852	0.0014	0.0090

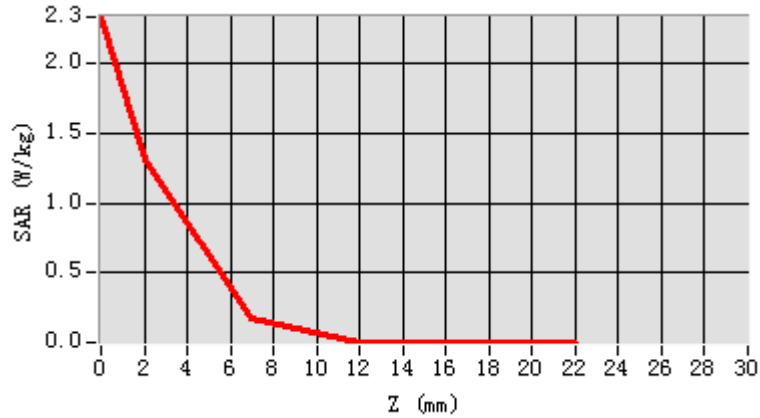

Hot spot position

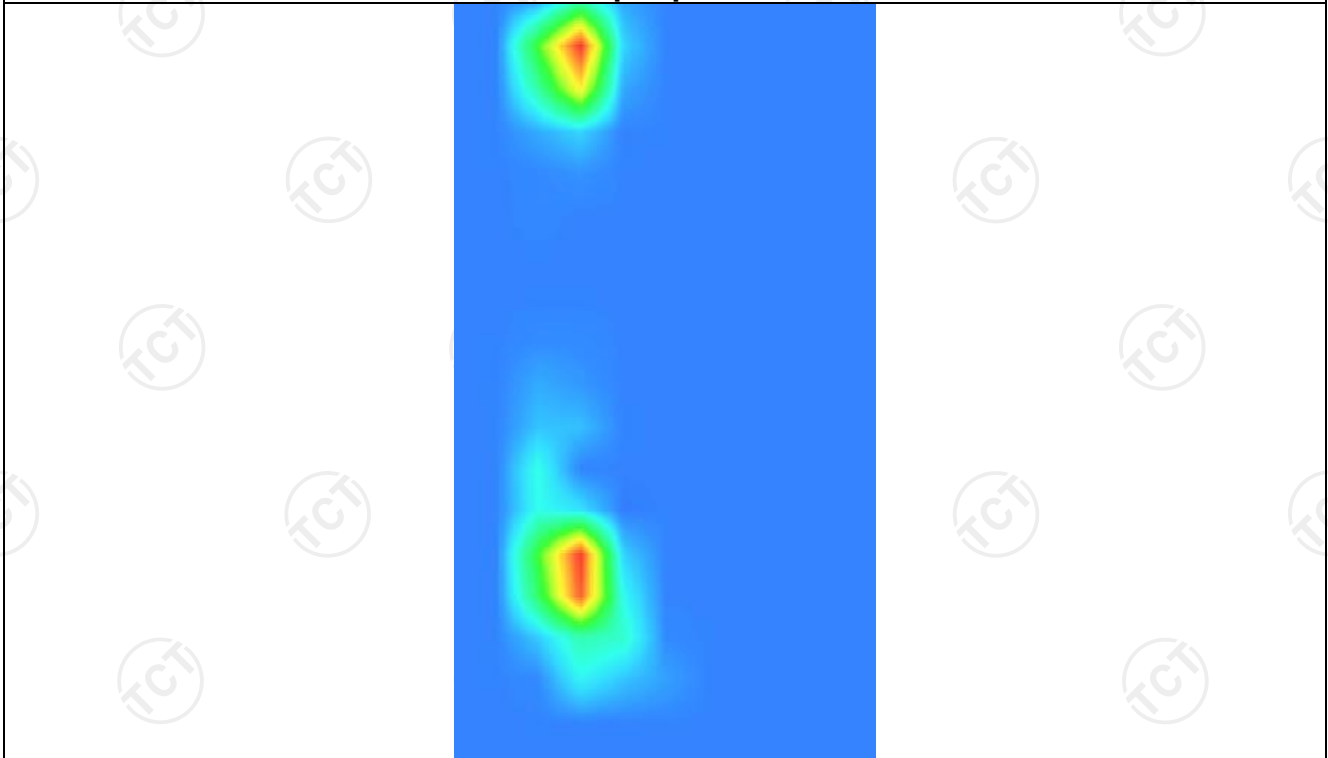

**MEASUREMENT 2**

Hight Band SAR (Channel 11):

Date: 08/11/2022

<b>Frequency (MHz)</b>	2462.000000
<b>Relative permittivity (real part)</b>	54.623847
<b>Relative permittivity (imaginary part)</b>	14.318478
<b>Conductivity (S/m)</b>	2.012374
<b>Variation (%)</b>	-2.640000
<b>Crest Factor</b>	1.0
<b>Probe Conversion factor</b>	4.70
<b>E-Field Probe:</b>	SSE2 (SN 25/22 EPGO375)
<b>Area Scan</b>	<u>dx=8mm dy=8mm, h= 5.00 mm</u>
<b>ZoomScan</b>	<u>5x5x7, dx=8mm dy=8mm</u> <u>dz=5mm, Complete/ndx=8mm dy=8mm, h=</u> <u>5.00 mm</u>
<b>Phantom</b>	Validation plane
<b>Device Position</b>	Body Left- vertical(external) (0mm)
<b>Band</b>	<u>IEEE 802.11n ISM</u>

**SURFACE SAR**

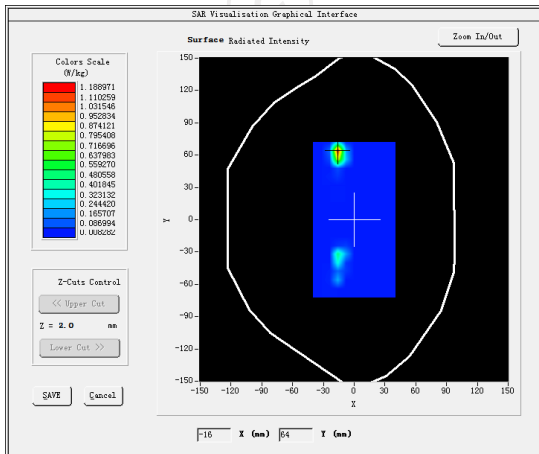

**VOLUME SAR**

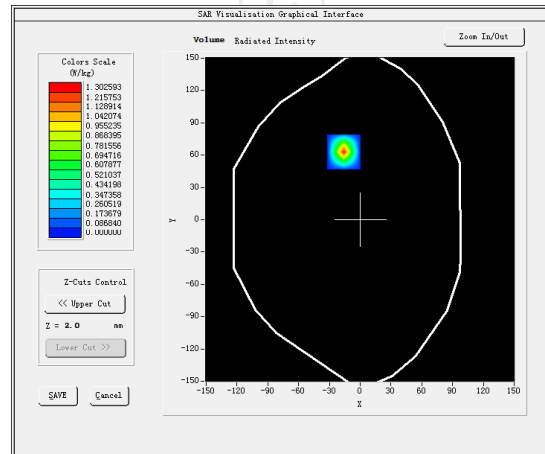

**Maximum location: X=-16.00, Y=63.00 SAR Peak: 2.40 W/kg**

**SAR 10g (W/Kg)**

0.216247

**SAR 1g (W/Kg)**

0.401543

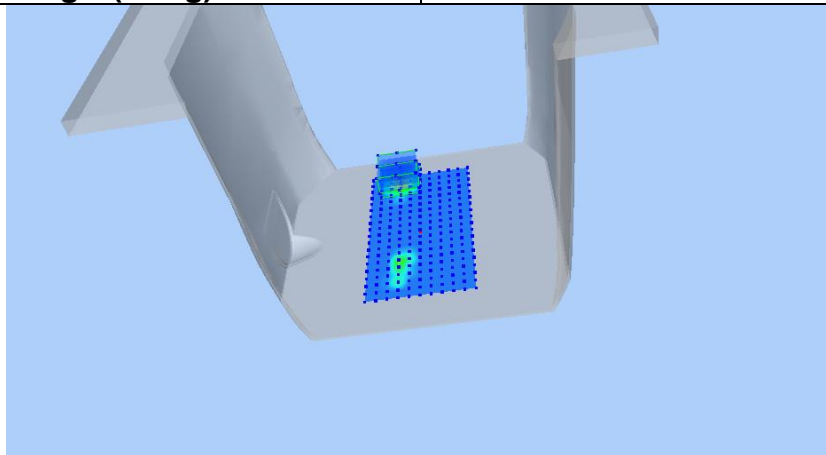

Z (mm)	0.00	2.00	7.00	12.00	17.00
SAR (W/Kg)	2.4010	1.3034	0.1262	0.0002	0.0042

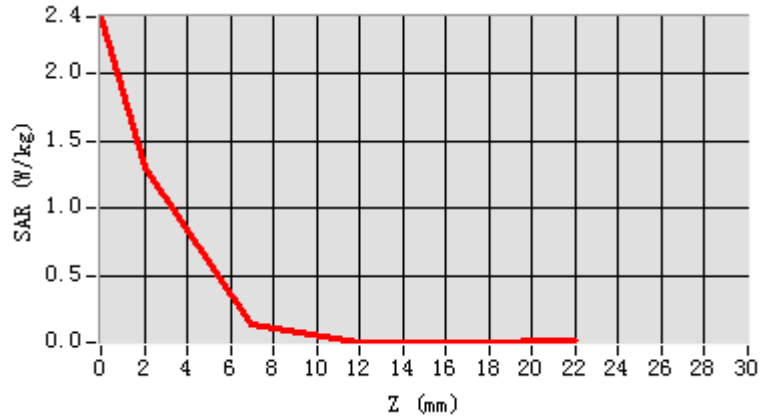

Hot spot position





**MEASUREMENT 3**

Hight Band SAR (Channel 11):

Date: 08/11/2022

<b>Frequency (MHz)</b>	2462.000000
<b>Relative permittivity (real part)</b>	54.630667
<b>Relative permittivity (imaginary part)</b>	14.318428
<b>Conductivity (S/m)</b>	1.982536
<b>Variation (%)</b>	-1.320000
<b>Crest Factor</b>	1.0
<b>Probe Conversion factor</b>	2.37
<b>E-Field Probe:</b>	SSE2 (SN 25/22 EPGO375)
<b>Area Scan</b>	<u>dx=8mm dy=8mm, h= 5.00 mm</u>
<b>ZoomScan</b>	<u>5x5x7,dx=8mm dy=8mm</u> <u>dz=5mm,Complete/ndx=8mm dy=8mm, h=</u> <u>5.00 mm</u>
<b>Phantom</b>	Validation plane
<b>Device Position</b>	Body Top(0mm)
<b>Band</b>	<u>IEEE 802.11n ISM</u>

**SURFACE SAR**

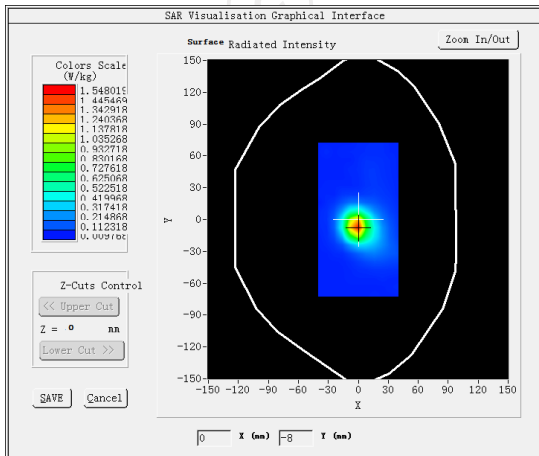

**VOLUME SAR**

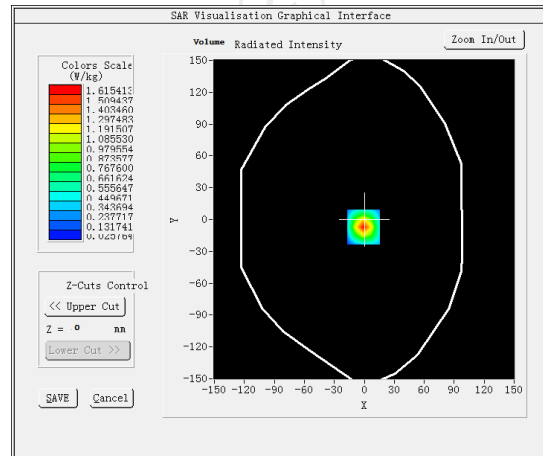

**Maximum location: X=-11.00, Y=-17.00 SAR Peak: 3.50 W/kg**

**SAR 10g (W/Kg)**

0.123072

**SAR 1g (W/Kg)**

0.429530

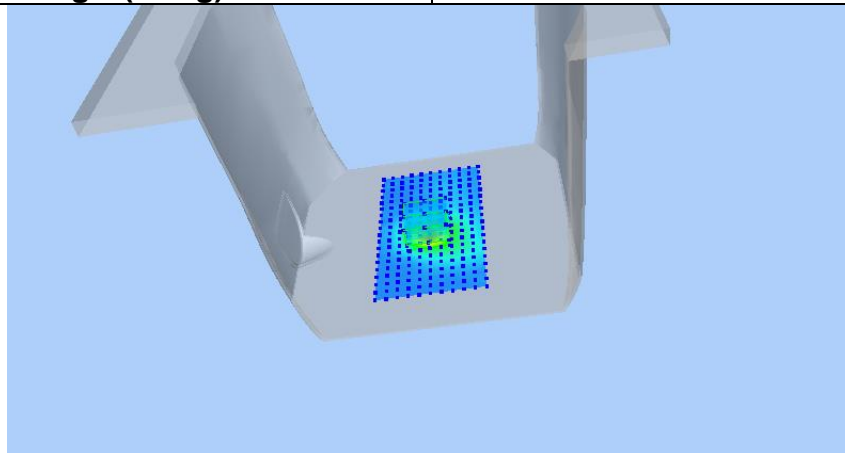

Z (mm)	0.00	4.00	9.00	14.00	19.00
SAR (W/Kg)	3.4980	1.6154	0.5133	0.1482	0.0600

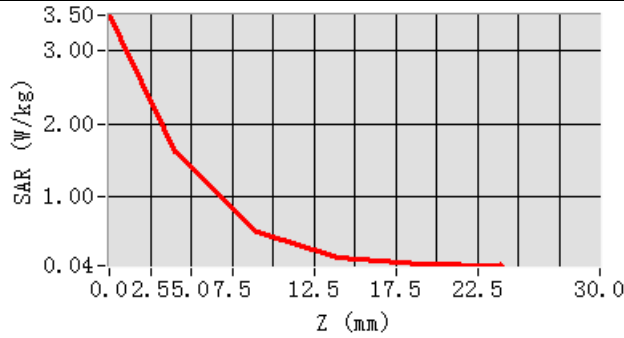

Hot spot position

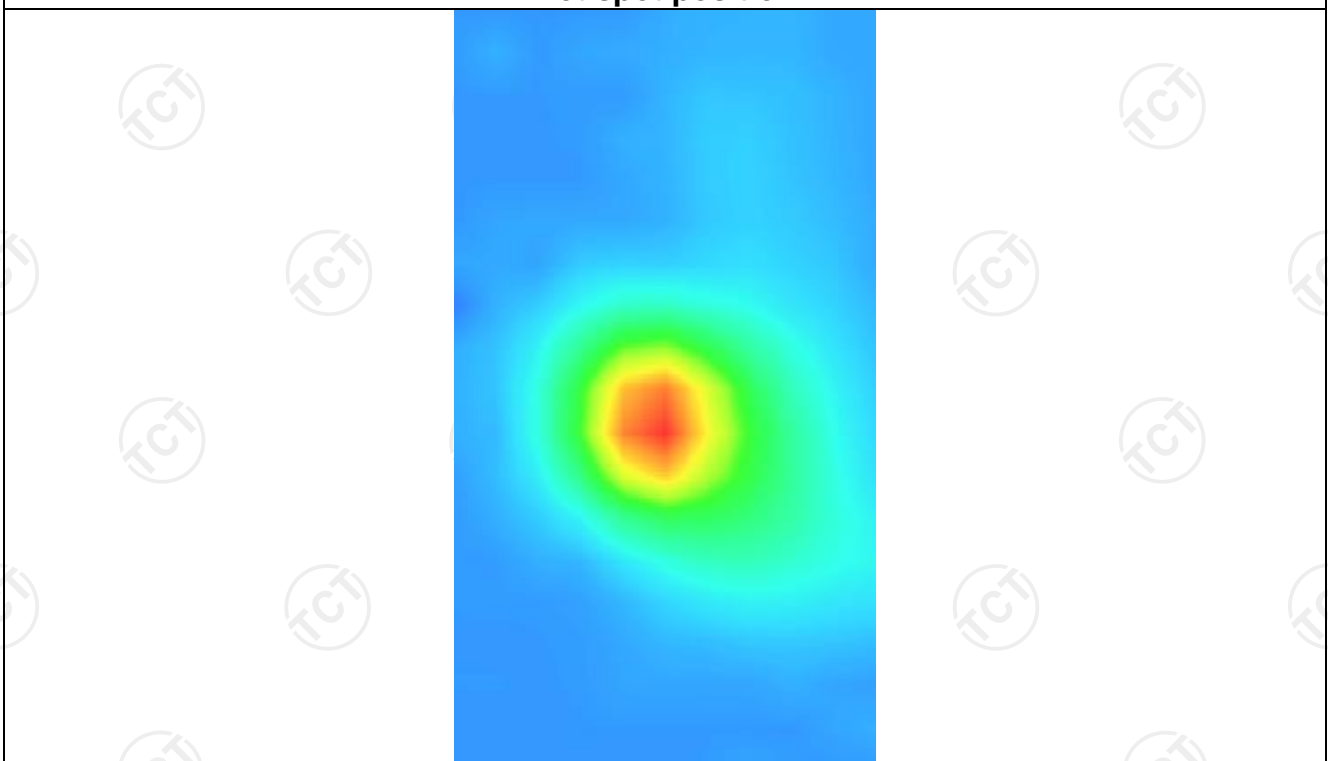

**Appendix A: EUT Photos**

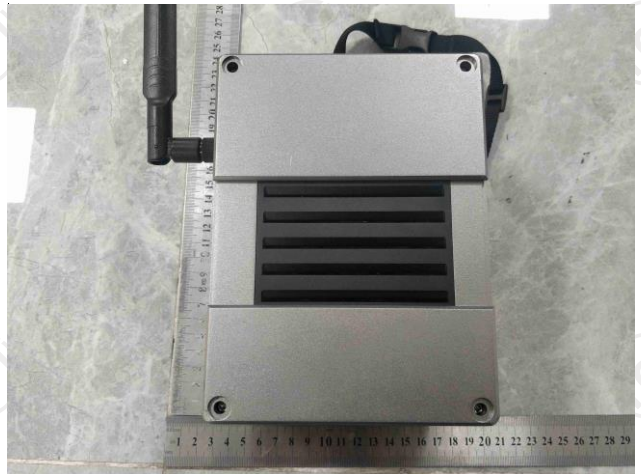

## Liquid depth



The Body Liquid of 2450MHz (15.3cm)

**Appendix B: Test Setup Photos**



Body worn –Left-level(external) (0 mm)

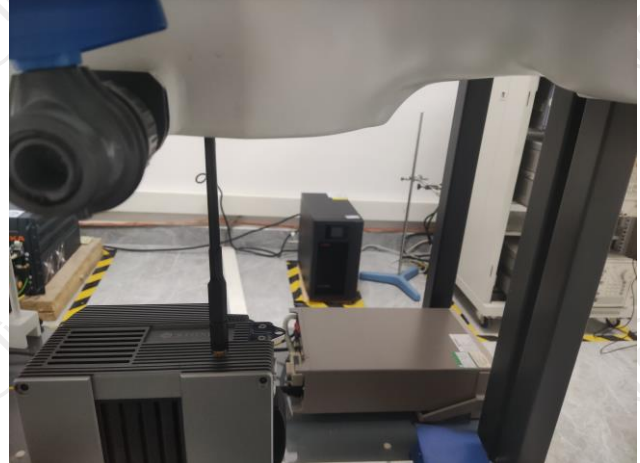

Body worn –Left- vertical(external) (0 mm)

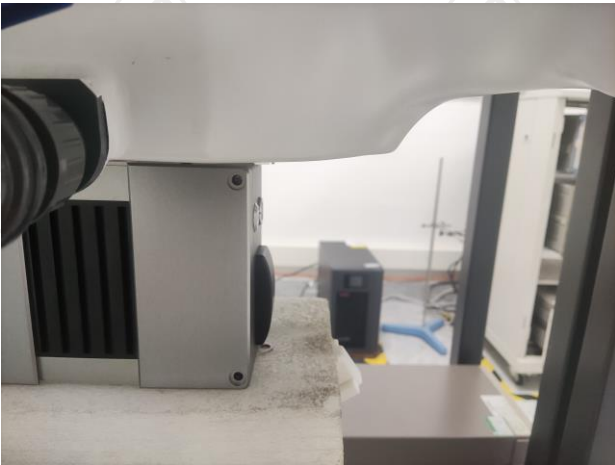

Body worn –Left (0 mm)



Body worn –Top (0 mm)

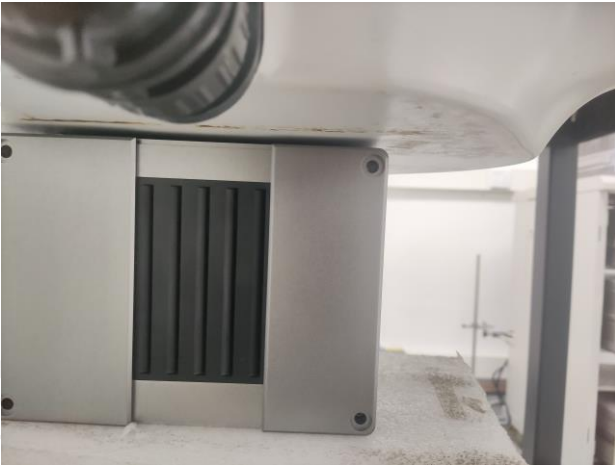

Body worn –Right (0 mm)



Body worn –Front (0 mm)



Body worn –Back (0 mm)

## Appendix C: Probe Calibration Certificate

COMOSAR E-FIELD Probe



### COMOSAR E-Field Probe Calibration Report

Ref : ACR.180.7.22.BES.B

**SHENZHEN TCT TESTING TECHNOLOGY CO.,LTD**  
2101 & 2201, ZHENCHANG FACTORY RENSHAN INDUSTRIAL  
ZONE, FUHAI SUBDISTRICT, BAO'AN DISTRICT SHENZHEN,  
GUANGDONG, CHINA

**MVG COMOSAR DOSIMETRIC E-FIELD PROBE**  
SERIAL NO.: SN 25/22 EPGO375

Calibrated at MVG  
Z.I. de la pointe du diable  
Technopôle Brest Iroise – 295 avenue Alexis de Rochon  
29280 PLOUZANE - FRANCE

Calibration date: 06/29/2022



Accreditations #2-6789  
Scope available on [www.cofrac.fr](http://www.cofrac.fr)

The use of the Cofrac brand and the accreditation references is prohibited from any reproduction.

#### Summary:

This document presents the method and results from an accredited COMOSAR Dosimetric E-Field Probe calibration performed at MVG, using the CALIPROBE test bench, for use with a MVG COMOSAR system only. The test results covered by accreditation are traceable to the International System of Units (SI).



COMOSAR E-FIELD PROBE CALIBRATION REPORT

Ref. ACR.180.7.22.BES.B

	Name	Function	Date	Signature
Prepared by :	Jérôme Le Gall	Measurement Responsible	6/30/2022	
Checked & approved by:	Jérôme Luc	Technical Manager	6/30/2022	
Authorized by:	Yann Toutain	Laboratory Director	7/05/2022	

2022.07.05  
09:30:00 +02'00'

	Customer Name
Distribution :	Shenzhen TCT Testing Technology Co.,Ltd

Issue	Name	Date	Modifications
A	Jérôme Le Gall	6/30/2022	Initial release





TABLE OF CONTENTS

1	Device Under Test .....	4
2	Product Description .....	4
2.1	General Information .....	4
3	Measurement Method .....	4
3.1	Linearity .....	4
3.2	Sensitivity .....	4
3.3	Lower Detection Limit .....	5
3.4	Isotropy .....	5
3.1	Boundary Effect .....	5
4	Measurement Uncertainty .....	6
5	Calibration Measurement Results .....	6
5.1	Sensitivity in air .....	6
5.2	Linearity .....	7
5.3	Sensitivity in liquid .....	8
5.4	Isotropy .....	9
6	List of Equipment .....	10



**1 DEVICE UNDER TEST**

Device Under Test	
Device Type	COMOSAR DOSIMETRIC E FIELD PROBE
Manufacturer	MVG
Model	SSE2
Serial Number	SN 25/22 EPGO375
Product Condition (new / used)	New
Frequency Range of Probe	0.15 GHz-6GHz
Resistance of Three Dipoles at Connector	Dipole 1: R1=0.197 MΩ Dipole 2: R2=0.230 MΩ Dipole 3: R3=0.208 MΩ

**2 PRODUCT DESCRIPTION**

**2.1 GENERAL INFORMATION**

MVG’s COMOSAR E field Probes are built in accordance to the IEC/IEEE 62209-1528 and FCC KDB865664 D01 standards.



**Figure 1 – MVG COMOSAR Dosimetric E field Probe**

Probe Length	330 mm
Length of Individual Dipoles	2 mm
Maximum external diameter	8 mm
Probe Tip External Diameter	2.5 mm
Distance between dipoles / probe extremity	1 mm

**3 MEASUREMENT METHOD**

The IEC/IEEE 62209-1528 and FCC KDB865664 D01 standards provide recommended practices for the probe calibrations, including the performance characteristics of interest and methods by which to assess their affect. All calibrations / measurements performed meet the fore mentioned standards.

**3.1 LINEARITY**

The evaluation of the linearity was done in free space using the waveguide, performing a power sweep to cover the SAR range 0.01W/kg to 100W/kg.

**3.2 SENSITIVITY**

The sensitivity factors of the three dipoles were determined using a two step calibration method (air and tissue simulating liquid) using waveguides as outlined in the standards.

Page: 4/11

*Template\_ACR.DDD.N.YY.MVGB.ISSUE\_COMOSAR Probe vK*

*This document shall not be reproduced, except in full or in part, without the written approval of MVG. The information contained herein is to be used only for the purpose for which it is submitted and is not to be released in whole or part without written approval of MVG.*



### 3.3 LOWER DETECTION LIMIT

The lower detection limit was assessed using the same measurement set up as used for the linearity measurement. The required lower detection limit is 10 mW/kg.

### 3.4 ISOTROPY

The axial isotropy was evaluated by exposing the probe to a reference wave from a standard dipole with the dipole mounted under the flat phantom in the test configuration suggested for system validations and checks. The probe was rotated along its main axis from 0 to 360 degrees in 15-degree steps. The hemispherical isotropy is determined by inserting the probe in a thin plastic box filled with tissue-equivalent liquid, with the plastic box illuminated with the fields from a half wave dipole. The dipole is rotated about its axis (0°–180°) in 15° increments. At each step the probe is rotated about its axis (0°–360°).

### 3.1 BOUNDARY EFFECT

The boundary effect is defined as the deviation between the SAR measured data and the expected exponential decay in the liquid when the probe is oriented normal to the interface. To evaluate this effect, the liquid filled flat phantom is exposed to fields from either a reference dipole or waveguide. With the probe normal to the phantom surface, the peak spatial average SAR is measured and compared to the analytical value at the surface.

The boundary effect uncertainty can be estimated according to the following uncertainty approximation formula based on linear and exponential extrapolations between the surface and  $d_{be} + d_{step}$  along lines that are approximately normal to the surface:

$$SAR_{uncertainty} [\%] = \Delta SAR_{be} \frac{(d_{be} + d_{step})^2}{2d_{step}} \frac{(e^{-d_{be}/(\delta/2)})}{\delta/2} \quad \text{for } (d_{be} + d_{step}) < 10 \text{ mm}$$

where

- $SAR_{uncertainty}$  is the uncertainty in percent of the probe boundary effect
- $d_{be}$  is the distance between the surface and the closest *zoom-scan* measurement point, in millimetre
- $\Delta_{step}$  is the separation distance between the first and second measurement points that are closest to the phantom surface, in millimetre, assuming the boundary effect at the second location is negligible
- $\delta$  is the minimum penetration depth in millimetres of the head tissue-equivalent liquids defined in this standard, i.e.,  $\delta \approx 14$  mm at 3 GHz;
- $\Delta SAR_{be}$  in percent of SAR is the deviation between the measured SAR value, at the distance  $d_{be}$  from the boundary, and the analytical SAR value.

The measured worst case boundary effect SAR uncertainty[%] for scanning distances larger than 4mm is 1.0% Limit ,2%).



**4 MEASUREMENT UNCERTAINTY**

The guidelines outlined in the IEC/IEEE 62209-1528 and FCC KDB865664 D01 standards were followed to generate the measurement uncertainty associated with an E-field probe calibration using the waveguide technique. All uncertainties listed below represent an expanded uncertainty expressed at approximately the 95% confidence level using a coverage factor of k=2, traceable to the Internationally Accepted Guides to Measurement Uncertainty.

Uncertainty analysis of the probe calibration in waveguide					
ERROR SOURCES	Uncertainty value (%)	Probability Distribution	Divisor	ci	Standard Uncertainty (%)
Expanded uncertainty 95 % confidence level k = 2					14 %

**5 CALIBRATION MEASUREMENT RESULTS**

Calibration Parameters	
Liquid Temperature	20 +/- 1 °C
Lab Temperature	20 +/- 1 °C
Lab Humidity	30-70 %

5.1 SENSITIVITY IN AIR

Normx dipole 1 (µV/(V/m) <sup>2</sup> )	Normy dipole 2 (µV/(V/m) <sup>2</sup> )	Normz dipole 3 (µV/(V/m) <sup>2</sup> )
0.64	0.53	0.44

DCP dipole 1 (mV)	DCP dipole 2 (mV)	DCP dipole 3 (mV)
106	108	109

Calibration curves  $e_i=f(V)$  (i=1,2,3) allow to obtain E-field value using the formula:

$$E = \sqrt{E_1^2 + E_2^2 + E_3^2}$$



COMOSAR E-FIELD PROBE CALIBRATION REPORT

Ref: ACR.180.7.22.BES.B

Calibration curves

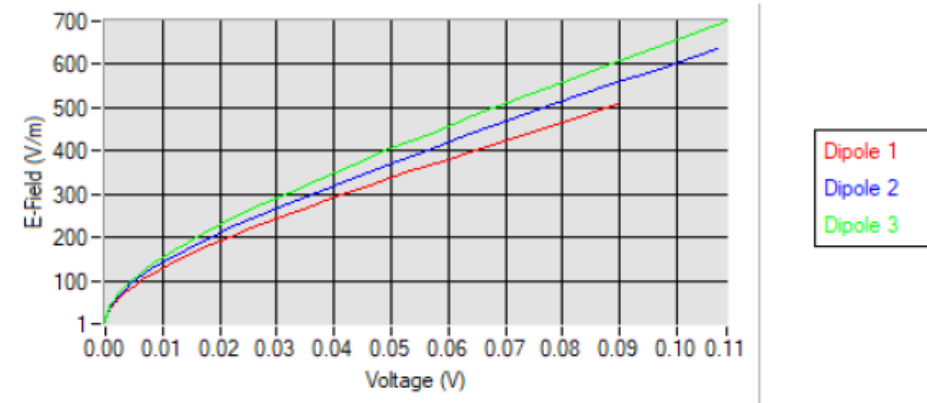

5.2 LINEARITY

Linearity

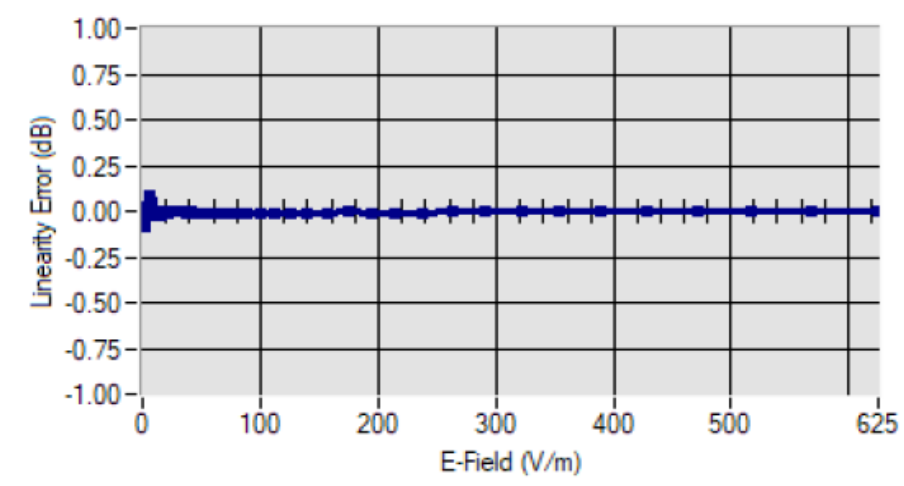

Linearity: +/-1.94% (+/-0.09dB)



COMOSAR E-FIELD PROBE CALIBRATION REPORT

Ref: ACR.180.7.22.BES.B

5.3 SENSITIVITY IN LIQUID

<u>Liquid</u>	<u>Frequency (MHz +/- 100MHz)</u>	<u>ConvF</u>
HL750	750	1.71
BL750	750	1.78
HL900	900	1.91
BL900	900	1.96
HL1800	1800	2.08
BL1800	1800	2.16
HL2000	2000	2.03
BL2000	2000	2.10
HL2450	2450	2.31
BL2450	2450	2.37
HL2600	2600	2.16
BL2600	2600	2.23
HL3500	3500	2.21
BL3500	3500	2.28
HL3700	3700	3.45
BL3700	3700	3.15
HL4600	4600	3.30
BL4600	4600	3.70
HL5200	5200	2.01
BL5200	5200	2.08
HL5600	5600	2.07
BL5600	5600	2.12
HL5800	5800	2.06
BL5800	5800	2.13

LOWER DETECTION LIMIT: 7mW/kg



5.4 ISOTROPY

HL1800 MHz

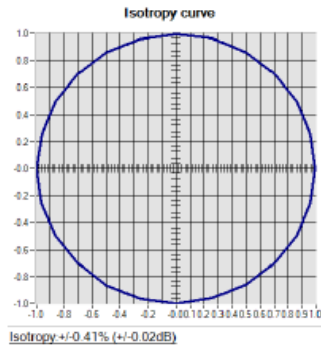



**6 LIST OF EQUIPMENT**

Equipment Summary Sheet				
Equipment Description	Manufacturer / Model	Identification No.	Current Calibration Date	Next Calibration Date
CALIPROBE Test Bench	Version 2	NA	Validated. No cal required.	Validated. No cal required.
Network Analyzer	Rohde & Schwarz ZVM	100203	08/2021	08/2024
Network Analyzer	Agilent 8753ES	MY40003210	10/2019	10/2022
Network Analyzer – Calibration kit	HP 85033D	3423A08186	06/2021	06/2027
Multimeter	Keithley 2000	1160271	02/2020	02/2023
Signal Generator	Rohde & Schwarz SMB	106589	03/2022	03/2025
Amplifier	MVG	MODU-023-C-0002	Characterized prior to test. No cal required.	Characterized prior to test. No cal required.
Power Meter	NI-USB 5680	170100013	06/2021	06/2024
Power Meter	Rohde & Schwarz NRVD	832839-056	11/2019	11/2022
Directional Coupler	Krytar 158020	131467	Characterized prior to test. No cal required.	Characterized prior to test. No cal required.
Waveguide	MVG	SN 32/16 WG4_1	Validated. No cal required.	Validated. No cal required.
Liquid transition	MVG	SN 32/16 WGLIQ_0G900_1	Validated. No cal required.	Validated. No cal required.
Waveguide	MVG	SN 32/16 WG6_1	Validated. No cal required.	Validated. No cal required.
Liquid transition	MVG	SN 32/16 WGLIQ_1G500_1	Validated. No cal required.	Validated. No cal required.
Waveguide	MVG	SN 32/16 WG8_1	Validated. No cal required.	Validated. No cal required.
Liquid transition	MVG	SN 32/16 WGLIQ_1G800B_1	Validated. No cal required.	Validated. No cal required.
Liquid transition	MVG	SN 32/16 WGLIQ_1G800H_1	Validated. No cal required.	Validated. No cal required.
Waveguide	MVG	SN 32/16 WG10_1	Validated. No cal required.	Validated. No cal required.
Liquid transition	MVG	SN 32/16 WGLIQ_3G500_1	Validated. No cal required.	Validated. No cal required.
Waveguide	MVG	SN 32/16 WG12_1	Validated. No cal required.	Validated. No cal required.

Page: 10/11

**Template\_ACR.DDD.N.YY.MVGB.ISSUE\_COMOSAR Probe vK**

*This document shall not be reproduced, except in full or in part, without the written approval of MVG. The information contained herein is to be used only for the purpose for which it is submitted and is not to be released in whole or part without written approval of MVG.*





COMOSAR E-FIELD PROBE CALIBRATION REPORT

Ref: ACR.180.7.22.BES.B

Liquid transition	MVG	SN 32/16 WGLIQ_5G000_1	Validated. No cal required.	Validated. No cal required.
Temperature / Humidity Sensor	Testo 184 H1	44225320	06/2021	06/2024



## Dielectric Probe Calibration Report

Ref : ACR.138.4.33.SATU.A

**SHENZHEN TCT TESTING TECHNOLOGY CO., LTD**  
**2101&2201, ZHENCHANG FACTORY, RENSHAN**  
**INDUSTRIAL ZONE, FUHAI SUBDISTRICT, BAOAN**  
**DISTRICT, SHENZHEN, GUANGDONG, 518103,**  
**PEOPLES REPUBLIC OF CHINA**

**MVG COMOSAR DOSIMETRIC E-FIELD PROBE**

**FREQUENCY: 0.3-6 GHZ**

**SERIAL NO.: SN 19/15 OCPG 71**

**Calibrated at MVG US**  
**2105 Barrett Park Dr. - Kennesaw, GA 30144**



**Calibration Date: 06/05/2021**

*Summary:*

This document presents the method and results from an accredited Dielectric Probe calibration performed in MVG USA using the LIMESAR test bench. All calibration results are traceable to national metrology institutions.



SAR DIELECTRIC PROBE CALIBRATION REPORT

Ref: ACR.138.4.33..SATUA

	Name	Function	Date	Signature
Prepared by :	Jérôme LUC	Product Manager	06/05/2021	<i>JS</i>
Checked by :	Jérôme LUC	Product Manager	06/05/2021	<i>JS</i>
Approved by :	Kim RUTKOWSKI	Quality Manager	06/05/2021	<i>Kim Rutkowski</i>

	Customer Name
Distribution :	SHENZHEN TCT TESTING TECHNOLOGY CO., LTD

Issue	Date	Modifications
A	06/05/2021	Initial release



TABLE OF CONTENTS

1	Introduction.....	4
2	Device Under Test .....	4
3	Product Description .....	4
3.1	General Information .....	4
4	Measurement Method .....	5
4.1	Liquid Permittivity Measurements .....	5
5	Measurement Uncertainty .....	5
5.1	Dielectric Permittivity Measurement .....	5
6	Calibration Measurement Results.....	6
6.1	Liquid Permittivity Measurement .....	6
7	List of Equipment .....	7



**1 INTRODUCTION**

This document contains a summary of the suggested methods and requirements set forth by the IEEE 1528 and CEI/IEC 62209 standards for liquid permittivity measurements and the measurements that were performed to verify that the product complies with the fore mentioned standards.

**2 DEVICE UNDER TEST**

Device Under Test	
Device Type	LIMESAR DIELECTRIC PROBE
Manufacturer	MVG
Model	SCLMP
Serial Number	SN 19/15 OCPG 71
Product Condition (new / used)	Used

A yearly calibration interval is recommended.

**3 PRODUCT DESCRIPTION**

**3.1 GENERAL INFORMATION**

MVG's Dielectric Probes are built in accordance to the IEEE 1528 and CEI/IEC 62209 standards. The product is designed for use with the LIMESAR test bench only.



**Figure 1 – MVG LIMESAR Dielectric Probe**



**4 MEASUREMENT METHOD**

The IEEE 1528, OET 65 Bulletin C and CEI/IEC 62209-1 & 2 standards outline techniques for dielectric property measurements. The LIMESAR test bench employs one of the methods outlined in the standards, using a contact probe or open-ended coaxial transmission-line probe and vector network analyzer. The standards recommend the measurement of two reference materials that have well established and stable dielectric properties to validate the system, one for the calibration and one for checking the calibration. The LIMESAR test bench uses De-ionized water as the reference for the calibration and either DMS or Methanol as the reference for checking the calibration. The following measurements were performed to verify that the product complies with the fore mentioned standards.

**4.1 LIQUID PERMITTIVITY MEASUREMENTS**

The permittivity of a liquid with well established dielectric properties was measured and the measurement results compared to the values provided in the fore mentioned standards.

**5 MEASUREMENT UNCERTAINTY**

All uncertainties listed below represent an expanded uncertainty expressed at approximately the 95% confidence level using a coverage factor of k=2, traceable to the Internationally Accepted Guides to Measurement Uncertainty.

**5.1 DIELECTRIC PERMITTIVITY MEASUREMENT**

The following uncertainties apply to the Dielectric Permittivity measurement:

Uncertainty analysis of Permittivity Measurement					
ERROR SOURCES	Uncertainty value (+/-%)	Probability Distribution	Divisor	ci	Standard Uncertainty (+/-%)
Repeatability (n repeats, mid-band)	4.00%	N	1	1	4.000%
Deviation from reference liquid	5.00%	R	$\sqrt{3}$	1	2.887%
Network analyser-drift, linearity	2.00%	R	$\sqrt{3}$	1	1.155%
Test-port cable variations	0.00%	U	$\sqrt{2}$	1	0.000%
<b>Combined standard uncertainty</b>					5.066%
<b>Expanded uncertainty (confidence level of 95%, k = 2)</b>					10.0%

Uncertainty analysis of Conductivity Measurement					
ERROR SOURCES	Uncertainty value (+/-%)	Probability Distribution	Divisor	ci	Standard Uncertainty (+/-%)
Repeatability (n repeats, mid-band)	3.50%	N	1	1	3.500%
Deviation from reference liquid	3.00%	R	$\sqrt{3}$	1	1.732%
Network analyser-drift, linearity	2.00%	R	$\sqrt{3}$	1	1.155%
Test-port cable variations	0.00%	U	$\sqrt{2}$	1	0.000%
<b>Combined standard uncertainty</b>					4.072%
<b>Expanded uncertainty (confidence level of 95%, k = 2)</b>					8.1%



SAR DIELECTRIC PROBE CALIBRATION REPORT

Ref: ACR.138.4.33..SATU.A

6 CALIBRATION MEASUREMENT RESULTS

Measurement Condition

Software	LIMESAR
Liquid Temperature	21°C
Lab Temperature	21°C
Lab Humidity	44%

6.1 LIQUID PERMITTIVITY MEASUREMENT

A liquid of known characteristics (methanol at 20°C) is measured with the probe and the results (complex permittivity  $\epsilon' + j\epsilon''$ ) are compared with the well-known theoretical values for this liquid.

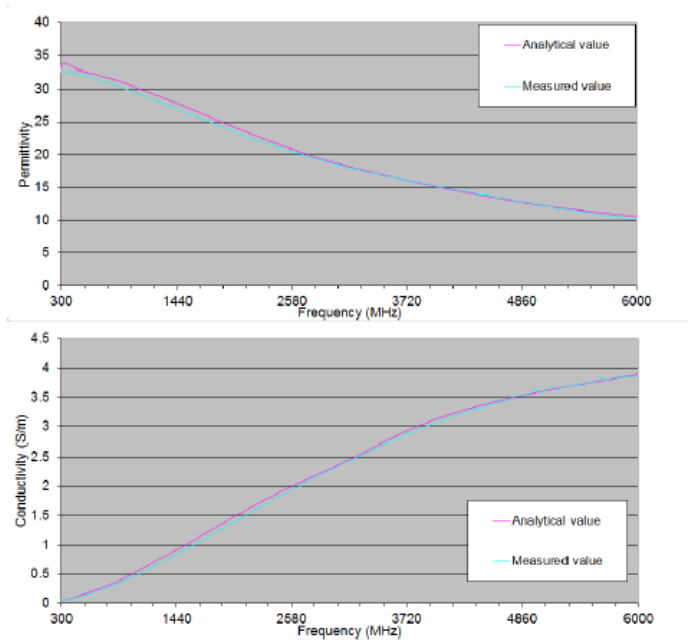



SAR DIELECTRIC PROBE CALIBRATION REPORT

Ref: ACR.138.4.33..SATU.A

7 LIST OF EQUIPMENT

Equipment Summary Sheet				
Equipment Description	Manufacturer / Model	Identification No.	Current Calibration Date	Next Calibration Date
LIMESAR Test Bench	Version 3	NA	Validated. No cal required.	Validated. No cal required.
Network Analyzer	Rhode & Schwarz ZVA	SN100132	02/2021	02/2024
Methanol CAS 67-56-1	Alpha Aesar	Lot D13W011	Validated. No cal required.	Validated. No cal required.
Temperature and Humidity Sensor	Control Company	11-661-9	09/2021	09/2022



## Appendix D: Dipole Calibration Report

SID2450



### SAR Reference Dipole Calibration Report

Ref : ACR.156.9.15.SATU.A

#### SHENZHEN TCT TESTING TECHNOLOGY CO., LTD

2101&2201, ZHENCHANG FACTORY, RENSHAN INDUSTRIAL  
FUHAI SUBDISTRICT, BAOAN DISTRICT, SHENZHEN,  
GUANGDONG, 518103, PEOPLES REPUBLIC OF CHINA

#### MVG COMOSAR REFERENCE DIPOLE

FREQUENCY: 2450 MHZ

SERIAL NO.: SN 16/15 DIP 2G450-374

Calibrated at MVG US

2105 Barrett Park Dr. - Kennesaw, GA 30144



Calibration Date: 06/05/2021

#### Summary:

This document presents the method and results from an accredited SAR reference dipole calibration performed in MVG USA using the COMOSAR test bench. All calibration results are traceable to national metrology institutions.



SAR REFERENCE DIPOLE CALIBRATION REPORT

Ref: ACR.156.9.15.SATU.A

	<i>Name</i>	<i>Function</i>	<i>Date</i>	<i>Signature</i>
<i>Prepared by :</i>	Jérôme LUC	Product Manager	06/05/2021	<i>JL</i>
<i>Checked by :</i>	Jérôme LUC	Product Manager	06/05/2021	<i>JL</i>
<i>Approved by :</i>	Kim RUTKOWSKI	Quality Manager	06/05/2021	<i>Kim Rutkowski</i>

	<i>Customer Name</i>
<i>Distribution :</i>	SHENZHEN TCT TESTING TECHNOLOGY CO., LTD

<i>Issue</i>	<i>Date</i>	<i>Modifications</i>
A	06/05/2021	Initial release



SAR REFERENCE DIPOLE CALIBRATION REPORT

Ref: ACR.156.9.15.SATU.A

	Name	Function	Date	Signature
Prepared by :	Jérôme LUC	Product Manager	06/05/2021	<i>JLS</i>
Checked by :	Jérôme LUC	Product Manager	06/05/2021	<i>JLS</i>
Approved by :	Kim RUTKOWSKI	Quality Manager	06/05/2021	<i>Kim Rutkowski</i>

	Customer Name
Distribution :	SHENZHEN TCT TESTING TECHNOLOGY CO., LTD

Issue	Date	Modifications
A	06/05/2021	Initial release



TABLE OF CONTENTS

1	Introduction.....	4
2	Device Under Test .....	4
3	Product Description .....	4
3.1	General Information .....	4
4	Measurement Method .....	5
4.1	Return Loss Requirements .....	5
4.2	Mechanical Requirements .....	5
5	Measurement Uncertainty .....	5
5.1	Return Loss .....	5
5.2	Dimension Measurement .....	5
5.3	Validation Measurement .....	5
6	Calibration Measurement Results .....	6
6.1	Return Loss and Impedance In Head Liquid .....	6
6.2	Return Loss and Impedance In Body Liquid .....	6
6.3	Mechanical Dimensions .....	6
7	Validation measurement .....	7
7.1	Head Liquid Measurement .....	7
7.2	SAR Measurement Result With Head Liquid .....	8
7.3	Body Liquid Measurement .....	9
7.4	SAR Measurement Result With Body Liquid .....	10
8	List of Equipment .....	11



**1 INTRODUCTION**

This document contains a summary of the requirements set forth by the IEEE 1528, FCC KDBs and CEI/IEC 62209 standards for reference dipoles used for SAR measurement system validations and the measurements that were performed to verify that the product complies with the fore mentioned standards.

**2 DEVICE UNDER TEST**

Device Under Test	
Device Type	COMOSAR 2450 MHz REFERENCE DIPOLE
Manufacturer	MVG
Model	SID2450
Serial Number	SN 16/15 DIP 2G450-374
Product Condition (new / used)	Used

A yearly calibration interval is recommended.

**3 PRODUCT DESCRIPTION**

**3.1 GENERAL INFORMATION**

MVG's COMOSAR Validation Dipoles are built in accordance to the IEEE 1528, FCC KDBs and CEI/IEC 62209 standards. The product is designed for use with the COMOSAR test bench only.



**Figure 1 – MVG COMOSAR Validation Dipole**



#### 4 MEASUREMENT METHOD

The IEEE 1528, FCC KDBs and CEI/IEC 62209 standards provide requirements for reference dipoles used for system validation measurements. The following measurements were performed to verify that the product complies with the fore mentioned standards.

##### 4.1 RETURN LOSS REQUIREMENTS

The dipole used for SAR system validation measurements and checks must have a return loss of -20 dB or better. The return loss measurement shall be performed against a liquid filled flat phantom, with the phantom constructed as outlined in the fore mentioned standards.

##### 4.2 MECHANICAL REQUIREMENTS

The IEEE Std. 1528 and CEI/IEC 62209 standards specify the mechanical components and dimensions of the validation dipoles, with the dimensions frequency and phantom shell thickness dependent. The COMOSAR test bench employs a 2 mm phantom shell thickness therefore the dipoles sold for use with the COMOSAR test bench comply with the requirements set forth for a 2 mm phantom shell thickness.

#### 5 MEASUREMENT UNCERTAINTY

All uncertainties listed below represent an expanded uncertainty expressed at approximately the 95% confidence level using a coverage factor of  $k=2$ , traceable to the Internationally Accepted Guides to Measurement Uncertainty.

##### 5.1 RETURN LOSS

The following uncertainties apply to the return loss measurement:

Frequency band	Expanded Uncertainty on Return Loss
400-6000MHz	0.1 dB

##### 5.2 DIMENSION MEASUREMENT

The following uncertainties apply to the dimension measurements:

Length (mm)	Expanded Uncertainty on Length
3 - 300	0.05 mm

##### 5.3 VALIDATION MEASUREMENT

The guidelines outlined in the IEEE 1528, FCC KDBs, CENELEC EN50361 and CEI/IEC 62209 standards were followed to generate the measurement uncertainty for validation measurements.

Scan Volume	Expanded Uncertainty
1 g	20.3 %

Page: 5/11

*This document shall not be reproduced, except in full or in part, without the written approval of MVG.  
The information contained herein is to be used only for the purpose for which it is submitted and is not to be released in whole or part without written approval of MVG.*



SAR REFERENCE DIPOLE CALIBRATION REPORT

Ref: ACR.156.9.15.SATU.A

10 g	20.1 %
------	--------

**6 CALIBRATION MEASUREMENT RESULTS**

**6.1 RETURN LOSS AND IMPEDANCE IN HEAD LIQUID**

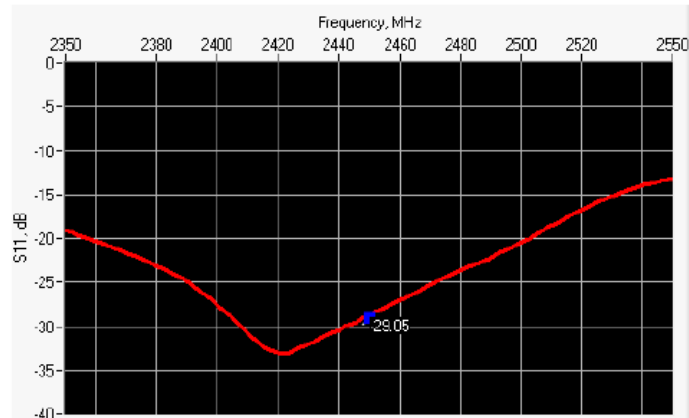

Frequency (MHz)	Return Loss (dB)	Requirement (dB)	Impedance
2450	-29.05	-20	46.7 $\Omega$ - 0.2 j $\Omega$

**6.2 RETURN LOSS AND IMPEDANCE IN BODY LIQUID**

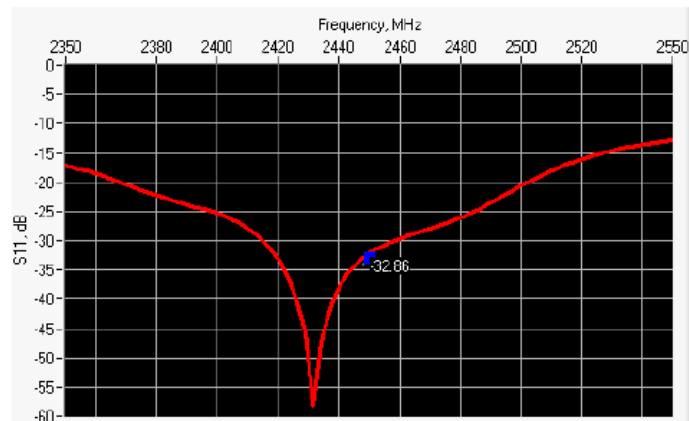

Frequency (MHz)	Return Loss (dB)	Requirement (dB)	Impedance
2450	-32.86	-20	48.6 $\Omega$ - 1.9 j $\Omega$

**6.3 MECHANICAL DIMENSIONS**

Frequency MHz	L mm		h mm		d mm	
	required	measured	required	measured	required	measured
300	420.0 $\pm$ 1 %		250.0 $\pm$ 1 %		6.35 $\pm$ 1 %	

Page: 6/11

*This document shall not be reproduced, except in full or in part, without the written approval of MVG. The information contained herein is to be used only for the purpose for which it is submitted and is not to be released in whole or part without written approval of MVG.*



SAR REFERENCE DIPOLE CALIBRATION REPORT

Ref: ACR.156.9.15.SATU.A

450	290.0 ±1 %.		166.7 ±1 %.		6.35 ±1 %.	
750	176.0 ±1 %.		100.0 ±1 %.		6.35 ±1 %.	
835	161.0 ±1 %.		89.8 ±1 %.		3.6 ±1 %.	
900	149.0 ±1 %.		83.3 ±1 %.		3.6 ±1 %.	
1450	89.1 ±1 %.		51.7 ±1 %.		3.6 ±1 %.	
1500	80.5 ±1 %.		50.0 ±1 %.		3.6 ±1 %.	
1640	79.0 ±1 %.		45.7 ±1 %.		3.6 ±1 %.	
1750	75.2 ±1 %.		42.9 ±1 %.		3.6 ±1 %.	
1800	72.0 ±1 %.		41.7 ±1 %.		3.6 ±1 %.	
1900	68.0 ±1 %.		39.5 ±1 %.		3.6 ±1 %.	
1950	66.3 ±1 %.		38.5 ±1 %.		3.6 ±1 %.	
2000	64.5 ±1 %.		37.5 ±1 %.		3.6 ±1 %.	
2100	61.0 ±1 %.		35.7 ±1 %.		3.6 ±1 %.	
2300	55.5 ±1 %.		32.6 ±1 %.		3.6 ±1 %.	
2450	51.5 ±1 %.	PASS	30.4 ±1 %.	PASS	3.6 ±1 %.	PASS
2600	48.5 ±1 %.		28.8 ±1 %.		3.6 ±1 %.	
3000	41.5 ±1 %.		25.0 ±1 %.		3.6 ±1 %.	
3500	37.0 ±1 %.		26.4 ±1 %.		3.6 ±1 %.	
3700	34.7 ±1 %.		26.4 ±1 %.		3.6 ±1 %.	

7 VALIDATION MEASUREMENT

The IEEE Std. 1528, FCC KDBs and CEI/IEC 62209 standards state that the system validation measurements must be performed using a reference dipole meeting the fore mentioned return loss and mechanical dimension requirements. The validation measurement must be performed against a liquid filled flat phantom, with the phantom constructed as outlined in the fore mentioned standards. Per the standards, the dipole shall be positioned below the bottom of the phantom, with the dipole length centered and parallel to the longest dimension of the flat phantom, with the top surface of the dipole at the described distance from the bottom surface of the phantom.

7.1 HEAD LIQUID MEASUREMENT

Frequency MHz	Relative permittivity ( $\epsilon_r'$ )		Conductivity ( $\sigma$ ) S/m	
	required	measured	required	measured
300	45.3 ±5 %		0.87 ±5 %	
450	43.5 ±5 %		0.87 ±5 %	
750	41.9 ±5 %		0.89 ±5 %	
835	41.5 ±5 %		0.90 ±5 %	
900	41.5 ±5 %		0.97 ±5 %	
1450	40.5 ±5 %		1.20 ±5 %	
1500	40.4 ±5 %		1.23 ±5 %	
1640	40.2 ±5 %		1.31 ±5 %	
1750	40.1 ±5 %		1.37 ±5 %	

Page: 7/11

*This document shall not be reproduced, except in full or in part, without the written approval of MVG. The information contained herein is to be used only for the purpose for which it is submitted and is not to be released in whole or part without written approval of MVG.*





SAR REFERENCE DIPOLE CALIBRATION REPORT

Ref: ACR.156.9.15.SATU.A

1800	40.0 ±5 %		1.40 ±5 %	
1900	40.0 ±5 %		1.40 ±5 %	
1950	40.0 ±5 %		1.40 ±5 %	
2000	40.0 ±5 %		1.40 ±5 %	
2100	39.8 ±5 %		1.49 ±5 %	
2300	39.5 ±5 %		1.67 ±5 %	
2450	39.2 ±5 %	PASS	1.80 ±5 %	PASS
2600	39.0 ±5 %		1.96 ±5 %	
3000	38.5 ±5 %		2.40 ±5 %	
3500	37.9 ±5 %		2.91 ±5 %	

7.2 SAR MEASUREMENT RESULT WITH HEAD LIQUID

The IEEE Std. 1528 and CEI/IEC 62209 standards state that the system validation measurements should produce the SAR values shown below (for phantom thickness of 2 mm), within the uncertainty for the system validation. All SAR values are normalized to 1 W forward power. In bracket, the measured SAR is given with the used input power.

Software	OPENSAR V4
Phantom	SN 20/09 SAM71
Probe	SN 18/11 EPG122
Liquid	Head Liquid Values: $\epsilon_{ps}$ : 38.3 $\sigma$ : 1.80
Distance between dipole center and liquid	10.0 mm
Area scan resolution	dx=8mm/dy=8mm
Zoon Scan Resolution	dx=5mm/dy=5mm/dz=5mm
Frequency	2450 MHz
Input power	20 dBm
Liquid Temperature	21 °C
Lab Temperature	21 °C
Lab Humidity	45 %

Frequency MHz	1 g SAR (W/kg/W)		10 g SAR (W/kg/W)	
	required	measured	required	measured
300	2.85		1.94	
450	4.58		3.06	
750	8.49		5.55	
835	9.56		6.22	
900	10.9		6.99	
1450	29		16	
1500	30.5		16.8	
1640	34.2		18.4	
1750	36.4		19.3	
1800	38.4		20.1	

Page: 8/11

*This document shall not be reproduced, except in full or in part, without the written approval of MVG. The information contained herein is to be used only for the purpose for which it is submitted and is not to be released in whole or part without written approval of MVG.*



SAR REFERENCE DIPOLE CALIBRATION REPORT

Ref: ACR.156.9.15.SATU.A

1900	39.7		20.5	
1950	40.5		20.9	
2000	41.1		21.1	
2100	43.6		21.9	
2300	48.7		23.3	
2450	52.4	53.26 (5.38)	24	24.15 (2.49)
2600	55.3		24.6	
3000	63.8		25.7	
3500	67.1		25	

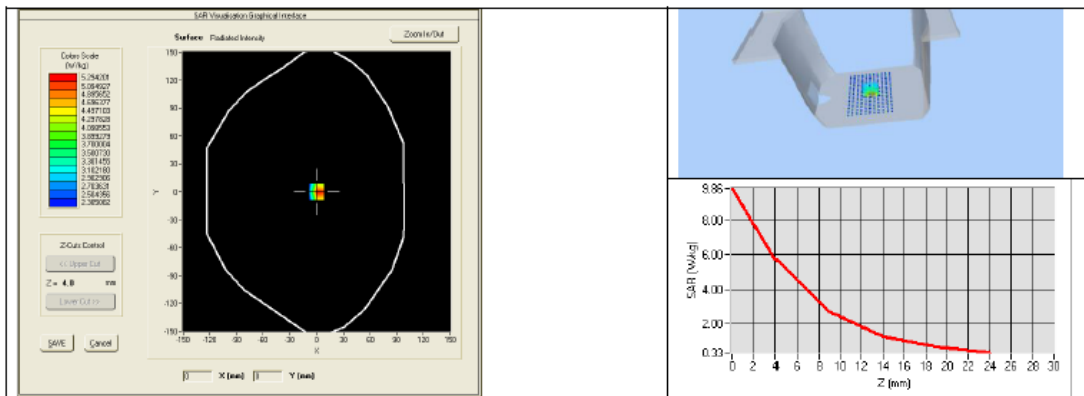

7.3 BODY LIQUID MEASUREMENT

Frequency MHz	Relative permittivity ( $\epsilon_r'$ )		Conductivity ( $\sigma$ ) S/m	
	required	measured	required	measured
150	61.9 ±5 %		0.80 ±5 %	
300	58.2 ±5 %		0.92 ±5 %	
450	56.7 ±5 %		0.94 ±5 %	
750	55.5 ±5 %		0.96 ±5 %	
835	55.2 ±5 %		0.97 ±5 %	
900	55.0 ±5 %		1.05 ±5 %	
915	55.0 ±5 %		1.06 ±5 %	
1450	54.0 ±5 %		1.30 ±5 %	
1610	53.8 ±5 %		1.40 ±5 %	
1800	53.3 ±5 %		1.52 ±5 %	
1900	53.3 ±5 %		1.52 ±5 %	
2000	53.3 ±5 %		1.52 ±5 %	
2100	53.2 ±5 %		1.62 ±5 %	
2450	52.7 ±5 %	PASS	1.95 ±5 %	PASS

Page: 9/11

*This document shall not be reproduced, except in full or in part, without the written approval of MVG. The information contained herein is to be used only for the purpose for which it is submitted and is not to be released in whole or part without written approval of MVG.*



SAR REFERENCE DIPOLE CALIBRATION REPORT

Ref: ACR.156.9.15.SATU.A

2600	52.5 ±5 %		2.16 ±5 %	
3000	52.0 ±5 %		2.73 ±5 %	
3500	51.3 ±5 %		3.31 ±5 %	
5200	49.0 ±10 %		5.30 ±10 %	
5300	48.9 ±10 %		5.42 ±10 %	
5400	48.7 ±10 %		5.53 ±10 %	
5500	48.6 ±10 %		5.65 ±10 %	
5600	48.5 ±10 %		5.77 ±10 %	
5800	48.2 ±10 %		6.00 ±10 %	

7.4 SAR MEASUREMENT RESULT WITH BODY LIQUID

Software	OPENSAR V4
Phantom	SN 20/09 SAM71
Probe	SN 18/11 EPG122
Liquid	Body Liquid Values: eps' : 52.7 sigma : 1.94
Distance between dipole center and liquid	10.0 mm
Area scan resolution	dx=8mm/dy=8mm
Zoon Scan Resolution	dx=5mm/dy=5mm/dz=5mm
Frequency	2450 MHz
Input power	20 dBm
Liquid Temperature	21 °C
Lab Temperature	21 °C
Lab Humidity	45 %

Frequency MHz	1 g SAR (W/kg/W)	10 g SAR (W/kg/W)
	measured	measured
2450	50.63 (5.01)	23.40 (2.37)

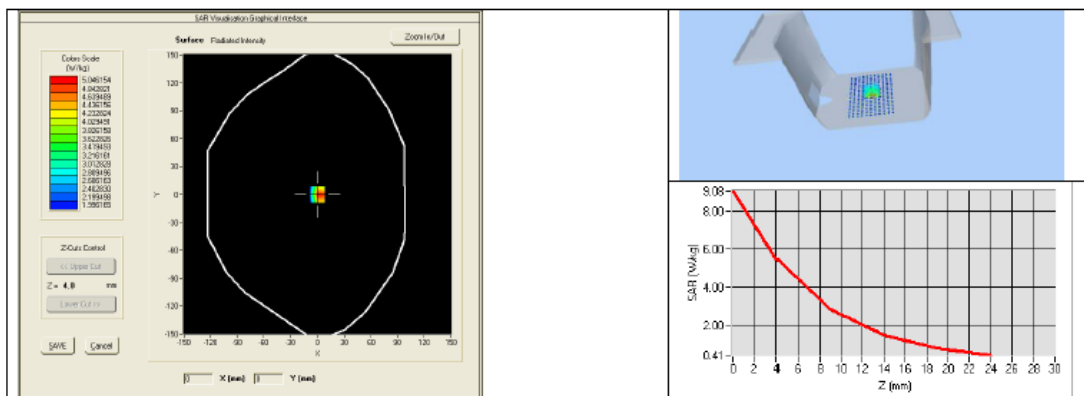

This document shall not be reproduced, except in full or in part, without the written approval of MVG. The information contained herein is to be used only for the purpose for which it is submitted and is not to be released in whole or part without written approval of MVG.



**8 LIST OF EQUIPMENT**

Equipment Summary Sheet				
Equipment Description	Manufacturer / Model	Identification No.	Current Calibration Date	Next Calibration Date
SAM Phantom	MVG	SN-20/09-SAM71	Validated. No cal required.	Validated. No cal required.
COMOSAR Test Bench	Version 3	NA	Validated. No cal required.	Validated. No cal required.
Network Analyzer	Rhode & Schwarz ZVA	SN100132	02/2021	02/2024
Calipers	Carrera	CALIPER-01	02/2021	02/2024
Reference Probe	MVG	EPG122 SN 18/11	02/2021	02/2022
Multimeter	Keithley 2000	1188656	02/2021	02/2024
Signal Generator	Agilent E4438C	MY49070581	02/2021	02/2024
Amplifier	Aethercomm	SN 046	Characterized prior to test. No cal required.	Characterized prior to test. No cal required.
Power Meter	HP E4418A	US38261498	02/2021	02/2024
Power Sensor	HP ECP-E26A	US37181460	02/2021	02/2024
Directional Coupler	Narda 4216-20	01386	Characterized prior to test. No cal required.	Characterized prior to test. No cal required.
Temperature and Humidity Sensor	Control Company	11-661-9	02/2021	02/2024

## Appendix E: SAR SYSTEM VALIDATION

Per FCC KDB 865664 D02v01, SAR system validation status should be documented to confirm measurement accuracy. The SAR systems (including SAR probes, system components and software versions) used for this device were validated against its performance specifications prior to the SAR measurements. Reference dipoles were used with the required tissue-equivalent media for system validation, according to the procedures outlined in FCC KDB 865664 D01 v01 and IEEE 1528-2013. Since SAR probe calibrations are frequency dependent, each probe calibration point was validated at a frequency within the valid frequency range of the probe calibration point, using the system that normally operates with the probe for routine SAR measurements and according to the required tissue-equivalent media.

A tabulated summary of the system validation status including the validation date(s), measurement frequencies, SAR probes and tissue dielectric parameters has been included.

### SAR System Validation Summary

Date	Freq. [MHz]	Probe S/N	Tissue type	COND. PERM.	COND. PERM.	CW Validation			Mod. Validation		
				( $\sigma$ )	( $\epsilon$ )	sensitivity	Probe linearity	Probe isotropy	Mod. type	Duty factor	Peak to average power ratio
12/10/2022	2450	SN 25/22 EPGO 375	Body	2.37	52.10	PASS	PASS	PASS	GMSK	PASS	N/A

NOTE: While the probes have been calibrated for both a CW and modulated signals, all measurements were performed using communication systems calibrated for CW signals only. Modulations in the table above represent test configurations for which the measurement system has been validated per FCC KDB Publication 865664 D01v01 for scenarios when CW probe calibrations are used with other signal types. SAR systems were validated for modulated signals with a periodic duty cycle, such as OFDM according to KDB 865664.

## Appendix F: The Check Data of Impedance and Return Loss

The information are included in the SAR report to qualify for the three-year extended calibration interval;

Impedance in body liquid							Date: 08/10/2022
Freq. (MHz)	Temp (°C)	Dipole Impedance Re(z)			Dipole Impedance Im(z)		
		measured	Target	$\Delta$ ( $\pm 5\Omega$ )	measured	Target	$\Delta$ ( $\pm 5\Omega$ )
2450	22	45.90	46.50	-0.60	-0.36	-0.20	-0.16

Return loss in body liquid				Date: 08/10/2022
Freq. (MHz)	Temp (°C)	Return loss(dB)		
		measured	Target	$\Delta$ ( $\pm 20\%$ )
2450	22	-34.65	-32.86	5.45

liquid	Freq. (MHz)	Temp (°C)	$\epsilon_r$ / relative permittivity			$\sigma$ (s/m) / conductivity			$\rho$ (kg/m <sup>3</sup> )
			measured	Target	$\Delta$ ( $\pm 5\%$ )	measured	Target	$\Delta$ ( $\pm 5\%$ )	
Body	2450	22	45.90	46.50	-0.60	-0.36	-0.20	-0.16	1000

Test Equipment	Manufacturer	Model	Serial Number	Calibration	
				Calibration Date (D.M.Y)	Calibration Due (D.M.Y)
Signal Generator	Agilent	N5182A	MY47070282	Jul. 04, 2022	Jul. 03, 2023
Multimeter	Keithley	Multimeter 2000	4078275	Jul. 04, 2022	Jul. 03, 2023
Network Analyzer	Agilent	8753E	US38432457	Jul. 04, 2022	Jul. 03, 2023
Power Meter	Agilent	E4418B	GB43312526	Jul. 04, 2022	Jul. 03, 2023
Power Sensor	Agilent	E9301A	MY41497725	Jul. 04, 2022	Jul. 03, 2023
Power Amplifier	PE	PE15A4019	112342	N/A	N/A
Temperature / Humidity Sensor	Control company	TH101B	152470214	Jul. 04, 2022	Jul. 03, 2023

\*\*\*\*\*END OF REPORT\*\*\*\*\*