



RF TEST REPORT

Product Name: Smart phone

Model Name: A151

FCC ID: 2A9SN-A151

Issued For : INOI Limited

Office 302, Dominion Centre 43-59, Queens Road, East
Wanchai, Hong Kong, China

Issued By : Shenzhen LGT Test Service Co., Ltd.

Room 205, Building 13, Zone B, Chen Hsong Industrial Park,
No.177 Renmin West Road, Jinsha Community, Kengzi
Street, Pingshan New District, Shenzhen, China

Report Number: LGT23A013RF04

Sample Received Date: Jan. 10, 2023

Date of Test: Jan. 10, 2023 ~ Feb. 15, 2023

Date of Issue: Feb. 15, 2023

The test report is effective only with both signature and specialized stamp. This report shall not be reproduced except in full without the written approval of the Laboratory. The results in this report only apply to the tested sample.

TEST REPORT CERTIFICATION

Applicant	INOI Limited
Address	Office 302, Dominion Centre 43-59, Queens Road, East Wanchai, Hong Kong, China
Manufacturer	INOI Limited
Address	Office 302, Dominion Centre 43-59, Queens Road, East Wanchai, Hong Kong, China
Product Name	Smart phone
Trademark	INOI
Model Name	A151
Sample Status:	Normal

APPLICABLE STANDARDS	
STANDARD	TEST RESULTS
FCC Part 22H and 24E KDB 971168 D01 v03r01, ANSI C63.26(2015)	PASS

Prepared by:

Zane Shan

Zane Shan
Engineer

Approved by:

Vita Li

Vita Li
Technical Director



Table of Contents	Page
1 SUMMARY OF TEST RESULTS	5
2 INTRODUCTION	6
2.1 TEST FACTORY	6
2.2 MEASUREMENT UNCERTAINTY	6
3. PRODUCT INFORMATION	7
4 TEST CONFIGURATION OF EQUIPMENT UNDER TEST	8
5 MEASUREMENT INSTRUMENTS	9
6 TEST ITEMS	10
6.1 CONDUCTED OUTPUT POWER	10
6.2 PEAK TO AVERAGE RATIO	11
6.3 TRANSMITTER RADIATED POWER (EIRP/ERP)	12
6.4 OCCUPIED BANDWIDTH	13
6.5 FREQUENCY STABILITY	14
6.6 SPURIOUS EMISSIONS AT ANTENNA TERMINALS	15
6.7 BAND EDGE	16
6.8 FIELD STRENGTH OF SPURIOUS RADIATION MEASUREMENT	17
APPENDIX I. TESTRESULT	19
2G	19
CONDUCTED OUTPUT POWER	19
FREQUENCY STABILITY	21
PEAK-TO-AVERAGE RATIO	22
OCCUPIED BANDWIDTH	28
BAND EDGE	35
OUT-OF-BAND EMISSIONS	40
FIELD STRENGTH OF SPURIOUS RADIATION	47
3G	59
CONDUCTED OUTPUT POWER	59
FREQUENCY STABILITY	62
PEAK-TO-AVERAGE RATIO	63
OCCUPIED BANDWIDTH	67
BAND EDGE	71
OUT-OF-BAND EMISSIONS	74
FIELD STRENGTH OF SPURIOUS RADIATION	78

Revision History

Rev.	Issue Date	Contents
00	Feb. 15, 2023	Initial Issue

1 SUMMARY OF TEST RESULTS

Test procedures according to the technical standards:

The radiated emission testing was performed according to the procedures of KDB 971168 D01 v03r01 and ANSI C63.26-2015

FCC Rules	Test Description	Test Limit	Test Result	Reference
2.1046	Conducted Output Power	Reporting Only	PASS	
22.913d 24.232d	Peak-to-Average Ratio	< 13 dB	PASS	
2.1046 22.913 24.232 27.50	Effective Radiated Power/Equivalent Isotropic Radiated Power	< 7 Watts max. ERP(Part 22) < 2 Watts max. EIRP(Part 24) <1 Watts max. EIRP(Part 27)	PASS	
2.1049 22.917 24.238 27.53	Occupied Bandwidth	Reporting Only	PASS	
2.1055 22.355 24.235 27.54	Frequency Stability	< 2.5 ppm (Part 22) Emission must remain in band (Part 24)	PASS	
2.1051 22.917 24.238 27.53	Spurious Emission at Antenna Terminals	< 43+10log10(P[Watts])	PASS	
2.1053 22.917 24.238 27.53	Field Strength of Spurious Radiation	< 43+10log10(P[Watts])	PASS	
2.1051 22.917 24.238 27.53	Band Edge	< 43+10log10(P[Watts])	PASS	

2 INTRODUCTION

2.1 TEST FACTORY

Company Name:	Shenzhen LGT Test Service Co., Ltd.
Address:	Room 205, Building 13, Zone B, Chen Hsong Industrial Park, No.177 Renmin West Road, Jinsha Community, Kengzi Street, Pingshan New District, Shenzhen, China
Accreditation Certificate	FCC Registration No.: 746540
	A2LA Certificate No.: 6727.01

2.2 MEASUREMENT UNCERTAINTY

The measurement uncertainties shown below were calculated in accordance with the requirements of ANSI C63.4-2014. All measurement uncertainty values are shown with a coverage factor of $k = 2$ to indicate a 95% level of confidence. The measurement data shown herein meets or exceeds the CISPR measurement uncertainty values specified in CISPR 16-4-2 and, thus, can be compared directly to specified limits to determine compliance.

No.	Item	Uncertainty
1	RF output power, conducted	$\pm 0.68\text{dB}$
2	Unwanted Emissions, conducted	$\pm 2.988\text{dB}$
3	All emissions, radiated 9K-30MHz	$\pm 2.84\text{dB}$
4	All emissions, radiated 30M-1GHz	$\pm 4.39\text{dB}$
5	All emissions, radiated 1G-6GHz	$\pm 5.10\text{dB}$
6	All emissions, radiated >6G	$\pm 5.48\text{dB}$
7	Conducted Emission (9KHz-150KHz)	$\pm 2.79\text{dB}$
8	Conducted Emission (150KHz-30MHz)	$\pm 2.80\text{dB}$

There're have 32GB and 64GB two kinds of memory configurations.

3. PRODUCT INFORMATION

Product Name	Smart phone
Trademark	INOI
Model Name	A151
Series Model	N/A
Model Difference	N/A
Tx Frequency:	GSM/GPRS/EDGE: GSM 850: 824 MHz ~ 849MHz GSM 1900: 1850 MHz ~ 1910MHz WCDMA: Band V: 824 MHz ~ 849 MHz Band II: 1850 MHz ~ 1910 MHz
Rx Frequency:	GSM/GPRS/EDGE: GSM 850: 869 MHz ~ 894 MHz GSM 1900: 1930 MHz ~ 1990MHz WCDMA: Band V: 869 MHz ~ 894 MHz Band II: 1930 MHz ~ 1990 MHz
Max RF Output Power:	GSM850:31.69dBm, PCS1900:30.02dBm GPRS850(1-Slot):31.73dBm, GPRS1900(1-Slot):30.19dBm GPRS850(2-Slot):28.96dBm, GPRS1900(2-Slot):26.44dBm GPRS850(3-Slot):27.06dBm, GPRS1900(3-Slot):24.80dBm GPRS850(4-Slot):25.00dBm, GPRS1900(4-Slot):22.70dBm EDGE 850(1-Slot):24.00dBm, EDGE 1900(1-Slot):25.89dBm EDGE 850(2-Slot):22.58dBm, EDGE 1900(2-Slot):24.45dBm EDGE 850(3-Slot):19.83dBm, EDGE 1900(3-Slot):22.09dBm EDGE 850(4-Slot):17.75dBm, EDGE 1900(4-Slot):20.23dBm WCDMA Band II:22.01dBm WCDMA Band V:20.57dBm WCDMA Band IV:20.74dBm
Modulation Characteristics:	GMSK for GSM/GPRS; GMSK and 8PSK for EDGE WCDMA: QPSK; HSDPA: QPSK/16QAM; HSUPA: BPSK
SIM Card:	SIM 1 and SIM 2 is a chipset unit and tested as single chipset, SIM 1 is used to tested.
Antenna:	PIFA
Antenna gain:	GSM 850: 0.1dBi GSM1900: -0.16dBi WCDMA II: -0.6dBi, WCDMA V: -1.9dBi, WCDMA IV:0.1dBi
Adapter	Model: IN-C01/19 Input: AC 100-240~50/60Hz 0.25A Output: DC 5V, 1.5A
Battery	Capacity: 5000mAh Rated Voltage: 3.85V

GPRS/EDGE Class:	Multi-Class12
Extreme Vol. Limits:	3.5V to 4.45V (Nominal 3.85V)
Extreme Temp. Tolerance:	-0°C to +40°C
Hardware version:	V4910A_PCB_MB_8L_1_HDI_V1.1
Software version r:	INOI_A151_12.0_INOI_RU_v01
** Note: The High Voltage 4.45 V and Low Voltage 3.5V was declared by manufacturer, The EUT couldn't be operate normally with higher or lower voltage, the antenna information refer the manufacturer provide report, applicable only to the tested sample identified in the report.	

4 TEST CONFIGURATION OF EQUIPMENT UNDER TEST

Antenna port conducted and radiated test items were performed according to KDB 971168 D01 and ANSI C63.26 2015 Power Meas. License Digital Systems with maximum output power.

Radiated measurements were performed with rotating EUT in different three orthogonal test planes to find the maximum emission.

Radiated emissions were investigated as following frequency range:

1. 30 MHz to 10th harmonic for GSM850 and WCDMA Band V.
2. 30 MHz to 10th harmonic for GSM1900 and WCDMA Band II.

All modes and data rates and positions were investigated.

Test modes are chosen to be reported as the worst-case configuration below:

BAND	TEST MODES	
	RADIATED TCS	CONDUCTED TCS
GSM 850	GSM LINK GPRS/EDGE CLASS 12 LINK	GSM LINK GPRS/EDGE CLASS 12 LINK
GSM 1900	GSM LINK GPRS/EDGE CLASS 12 LINK	GSM LINK GPRS/EDGE CLASS 12 LINK
WCDMA BAND V	RMC 12.2KBPS LINK	RMC 12.2KBPS LINK
WCDMA BAND II	RMC 12.2KBPS LINK	RMC 12.2KBPS LINK

5 MEASUREMENT INSTRUMENTS

Radiated Test equipment					
Equipment	Manufacturer	Model No.	Serial No.	Cal. Date	Cal. Until
EMI Test Receiver	R&S	ESU8	100372	2022.04.12	2023.04.11
Spectrum Analyzer	Keysight	N9010B	MY60242508	2022.04.29	2023.04.28
Bilog Antenna	Schwarzbeck	VULB 9168	01447	2022.12.12	2024.12.11
Horn Antenna	Schwarzbeck	3115	10SL0060	2022.06.02	2024.06.01
Pre-amplifier(0.1M-3GHz)	HP	8447D	2727A05655	2022.04.11	2023.04.10
Pre-amplifier(1-26.5G)	Agilent	8449B	3008A4722	2022.04.13	2023.04.12
RE Cable (9K-1G)	N.A	R01	N.A	2022.05.05	2023.05.04
RE Cable (1-26G)	N.A	R02	N.A	2022.05.05	2023.05.04
Wireless Communications Test Set	R&S	CMW 500	137737	2022.04.29	2023.04.28
Temperature & Humidity	KTJ	TA218B	N.A	2022.05.05	2023.05.04
Testing Software	EMC-I_V1.4.0.3_SKET				

Conducted Test equipment					
Equipment	Manufacturer	Model No.	Serial No.	Cal. Date	Cal. Until
Signal Analyzer	Keysight	N9010B	MY60242508	2022.04.29	2023.04.28
Wireless Communications Test Set	R&S	CMW 500	137737	2022.04.29	2023.04.28
MXG Vector Signal Generator	Keysight	N5182B	MY59100717	2022.06.02	2023.06.01
RF Automatic Test system	MW	MW100-RFCB	MW220324LG-33	2022.04.29	2023.04.28
Temperature & Humidity	KTJ	TA218B	N.A	2022.05.05	2023.05.04
Temperature & Humidity test chamber	AISRY	LX-1000L	171200018	2022.05.10	2023.05.09
Attenuator	eastsheep	90db	N.A	2022.04.29	2023.04.28
Router	WAVLINK	WL-WN575A2	WL1512260336	N.C.R	N.C.R
Router	TP-LINK	TL-WR885N	1125074010735	N.C.R	N.C.R
Testing Software	MTS8200_V2.0.0.0				

Equipment with a calibration date of “NCR” shown in this list was not used to make direct calibrated measurements.

6 TEST ITEMS

6.1 CONDUCTED OUTPUT POWER

TEST OVERVIEW

A system simulator was used to establish communication with the EUT. Its parameters were set to enforce EUT transmitting at the maximum power. The measured power in the radio frequency on the transmitter output terminals shall be reported.

TEST PROCEDURES

1. The transmitter output port was connected to the system simulator.
2. Set eut at maximum power through the system simulator.
3. Select lowest, middle, and highest channels for each band and different modulation.
4. Measure and record the power level from the system simulator.

TEST SETUP

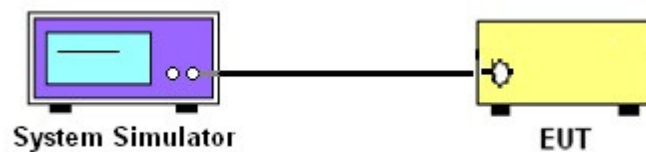

TEST RESULT

Note: Test data See APPENDIX I.

6.2 PEAK TO AVERAGE RATIO

TEST OVERVIEW

According to §24.232(d), power measurements for transmissions by stations authorized under this section may be made either in accordance with a commission-approved average power technique or in compliance with paragraph (e) of this section. In both instances, equipment employed must be authorized in accordance with the provisions of §24.51. In measuring transmissions in this band using an average power technique, the peak-to-average ratio (PAR) of the transmission may not exceed 13 db.

TEST PROCEDURES

1. The testing follows FCC KDB 971168 v03r01 section.
2. The eut was connected to the peak and av system simulator& spectrum analyzer.
3. Select lowest, middle, and highest channels for each band and different modulation.
4. Set the test probe and measure average power of the spectrum analysis,

TEST SETUP

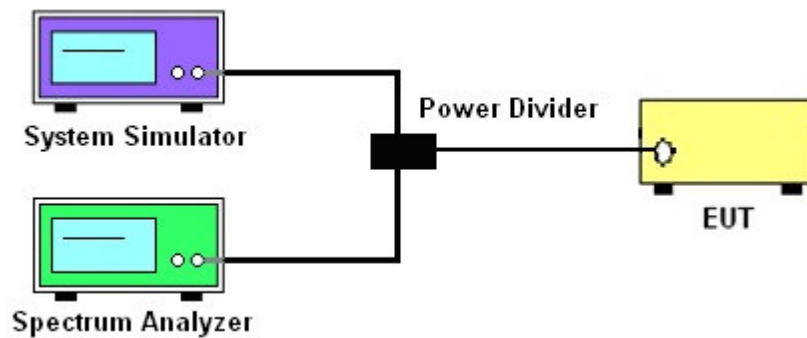

TEST RESULT

Note: Test data See APPENDIX I.

6.3 TRANSMITTER RADIATED POWER (EIRP/ERP)

TEST OVERVIEW

Effective Radiated Power (ERP) and Equivalent Isotropic Radiated Power (EIRP) measurements are performed using the substitution method described in ANSI C63.26 2015 with the EUT transmitting into an integral antenna. Measurements on signals operating below 1GHz are performed using vertically polarized tuned dipole antennas. Measurements on signals operating above 1GHz are performed using vertically polarized broadband horn antennas. All measurements are performed as RMS average measurements while the EUT is operating at maximum power, and at the appropriate frequencies.

TEST PROCEDURE

1. The testing follows FCC KDB 971168 Section 5.8 and ANSI C63.26-2015 Section 5.2.
2. The transmitter was placed on a wooden turntable, and it was transmitting into a non-radiating load which was also placed on the turntable.
3. The measurement antenna was placed at a distance of 3 meters from the EUT. During the tests, the antenna height and polarization as well as EUT azimuth were varied in order to identify the maximum level of emissions from the EUT. The test was performed by placing the EUT on 3-orthogonal axis.
4. The frequency range up to tenth harmonic of the fundamental frequency was investigated.
5. Remove the EUT and replace it with substitution antenna. A signal generator was connected to the substitution antenna by a nonradiating cable. The absolute levels of the spurious emissions were measured by the substitution.
6. Effective Isotropic Radiated Power (EIRP) was measured by substitution method according to ANSI C63.26-2015. The EUT was replaced by the substitution antenna at same location, and then a known power from S.G. was applied into the dipole antenna through a Tx cable, and then recorded the maximum Analyzer reading through raised and lowered the test antenna.
EIRP=S.G Level+ Gain-Cable loss; ERP=S.G Level+ Gain-Cable loss-2.15.

TEST RESULT

Note: Test data See APPENDIX I.

6.4 OCCUPIED BANDWIDTH

TEST OVERVIEW

The occupied bandwidth, that is the frequency bandwidth such that, below its lower and above its upper frequency limits, the mean powers radiated are each equal to 0.5 percent of the total mean power radiated by a given emission shall be measured.

The 26 dB emission bandwidth is defined as the frequency range between two points, one above and one below the carrier frequency, at which the spectral density of the emission is attenuated 26 dB below the maximum in-band spectral density of the modulated signal. Spectral density (power per unit bandwidth) is to be measured with a detector of resolution bandwidth equal to approximately 1.0% of the emission bandwidth.

All modes of operation were investigated and the worst case configuration results are reported in this section.

TEST PROCEDURE

1. The signal analyzer's automatic bandwidth measurement capability was used to perform the 99% occupied bandwidth and the 26dB bandwidth. The bandwidth measurement was not influenced by any intermediate power nulls in the fundamental emission.
2. RBW = 1 – 5% of the expected OBW
3. VBW $\geq 3 \times$ RBW
4. Detector = Peak
5. Trace mode = max hold
6. Sweep = auto couple
7. The trace was allowed to stabilize
8. If necessary, steps 2 – 7 were repeated after changing the RBW such that it would be within 1 – 5% of the 99% occupied bandwidth observed in Step 7

TEST SETUP

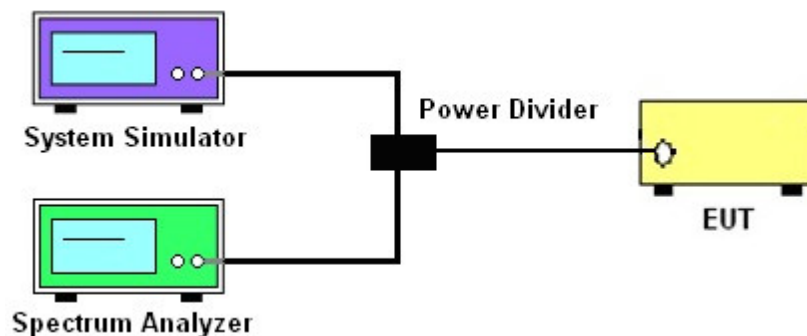

TEST RESULT

Note: Test data See APPENDIX I.

6.5 FREQUENCY STABILITY

TEST OVERVIEW

Frequency stability testing is performed in accordance with the guidelines of ANSI C63.26 2015.

The frequency stability of the transmitter is measured by:

- a.) Temperature: The temperature is varied from -30°C to $+50^{\circ}\text{C}$ in 10°C increments using an environmental chamber.
- b.) Primary Supply Voltage: The primary supply voltage is varied from 85% to 115% of the nominal value for non hand-carried battery and AC powered equipment. For hand-carried, battery-powered equipment, primary supply voltage is reduced to the battery operating end point which shall be specified by the manufacturer.

For Part 22, the frequency stability of the transmitter shall be maintained within $\pm 0.00025\%$ (± 2.5 ppm) of the center frequency. For Part 24 the frequency stability shall be sufficient to ensure that the fundamental emission stays within the authorized frequency block.

TEST PROCEDURE

Temperature Variation

1. The testing follows FCC KDB 971168 D01 section 9.0
2. The EUT was set up in the thermal chamber and connected with the system simulator.
3. With power OFF, the temperature was decreased to -30°C and the EUT was stabilized before testing. Power was applied and the maximum change in frequency was recorded within one minute.
4. With power OFF, the temperature was raised in 10°C steps up to 50°C . The EUT was stabilized at each step for at least half an hour. Power was applied and the maximum frequency change was recorded within one minute.

Voltage Variation

1. The testing follows FCC KDB 971168 D01 Section 9.0.
2. The EUT was placed in a temperature chamber at $25\pm 5^{\circ}\text{C}$ and connected with the system simulator.
3. The power supply voltage to the EUT was varied from 85% to 115% of the nominal value measured at the input to the EUT.
4. The variation in frequency was measured for the worst case.

TEST SETUP

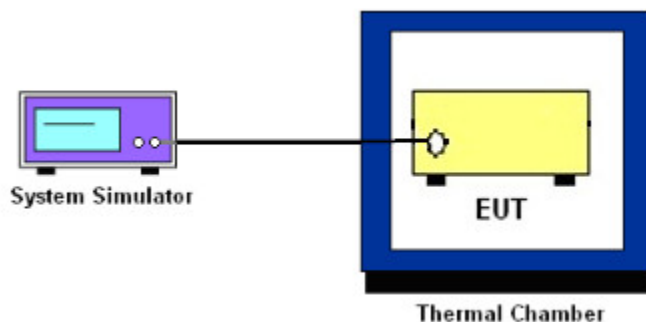

TEST RESULT

Note: Test data See APPENDIX I.

6.6 SPURIOUS EMISSIONS AT ANTENNA TERMINALS

TEST OVERVIEW

The power of any emission outside of the authorized operating frequency ranges must be lower than the transmitter power (P) by a factor of at least $43 + 10 \log (P)$ dB.

It is measured by means of a calibrated spectrum analyzer and scanned from 30 MHz up to a frequency including its 10th harmonic.

TEST PROCEDURE

1. The testing FCC KDB 971168 D01 v03r01 Section 6.0. and ANSI C63.26-2015-Section 5.7.
2. The EUT was connected to the spectrum analyzer and system simulator via a power divider.
3. The RF output of EUT was connected to the spectrum analyzer by an RF cable and attenuator. The path loss was compensated to the results for each measurement.
4. The middle channel for the highest RF power within the transmitting frequency was measured.
5. The conducted spurious emission for the whole frequency range was taken.
6. The RF fundamental frequency should be excluded against the limit line in the operating frequency band.

7. The limit line is derived from $43 + 10\log(P)$ dB below the transmitter power P(Watts)

$$= P(W) - [43 + 10\log(P)] \text{ (dB)}$$

$$= [30 + 10\log(P)] \text{ (dBm)} - [43 + 10\log(P)] \text{ (dB)}$$

$$= -13\text{dBm}.$$

TEST SETUP

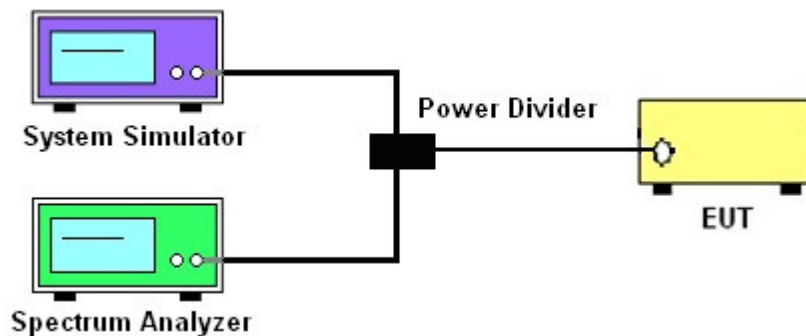

TEST RESULT

Note: Test data See APPENDIX I.

6.7 BAND EDGE

TEST OVERVIEW

All out of band emissions are measured with a spectrum analyzer connected to the antenna terminal of the EUT while the EUT is operating at maximum power, and at the appropriate frequencies. All data rates were investigated to determine the worst case configuration. All modes of operation were investigated and the worst case configuration results are reported in this section.

The minimum permissible attenuation level of any spurious emission is $43 + \log_{10}(P[\text{Watts}])$, where P is the transmitter power in Watts.

TEST PROCEDURE

1. The testing FCC KDB 971168 D01 v03r01 Section 6.0 and ANSI C63.26-2015-Section 5.7
2. Start and stop frequency were set such that the band edge would be placed in the center of the Plot.
3. The EUT was connected to the spectrum analyzer and system simulator via a power divider.
4. The RF output of EUT was connected to the spectrum analyzer by an RF cable and attenuator. The path loss was compensated to the results for each measurement.
5. The band edges of low and high channels for the highest RF powers were measured.
6. The RF fundamental frequency should be excluded against the limit line in the operating frequency band.

7. The limit line is derived from $43 + 10\log(P)$ dB below the transmitter power P(Watts)
 $= P(\text{W}) - [43 + 10\log(P)] (\text{dB})$
 $= [30 + 10\log(P)] (\text{dBm}) - [43 + 10\log(P)] (\text{dB})$
 $= -13\text{dBm}.$

TEST SETUP

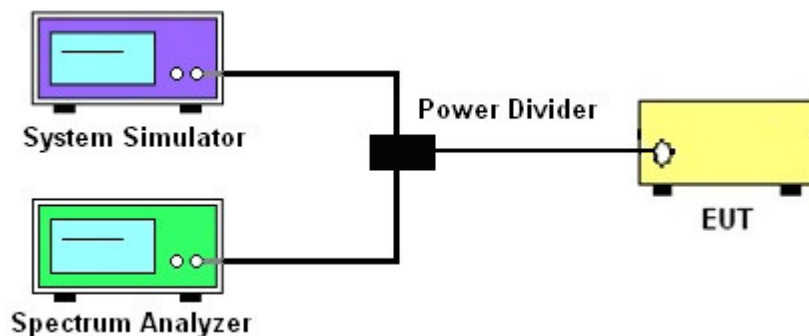

TEST RESULT

Note: Test data See APPENDIX I.

6.8 FIELD STRENGTH OF SPURIOUS RADIATION MEASUREMENT

TEST OVERVIEW

Radiated spurious emissions measurements are performed using the substitution method described in ANSI C63.26-2015 with the EUT transmitting into an integral antenna. Measurements on signals operating below 1GHz are performed using horizontally and vertically polarized tuned dipole antennas. Measurements on signals operating above 1GHz are performed using vertically and horizontally polarized horn antennas. All measurements are performed as peak measurements while the EUT is operating at maximum power and at the appropriate frequencies.

It is measured by means of a calibrated spectrum analyzer and scanned from 30 MHz up to a frequency including its 10th harmonic.

TEST PROCEDURE

1. The testing FCC KDB 971168 D01 Section 5.8 and ANSI C63.26-2015-Section 5.5.
2. RBW = 100kHz for emissions below 1GHz and 1MHz for emissions above 1GHz
3. VBW $\geq 3 \times$ RBW
4. Span = 1.5 times the OBW
5. No. of sweep points $> 2 \times$ span/RBW
6. Detector = Peak
7. Trace mode = max hold
8. The trace was allowed to stabilize
9. Effective Isotropic Spurious Radiation was measured by substitution method according to TIA/EIA-603-D. The EUT was replaced by the substitution antenna at same location, and then a known power from S.G. was applied into the dipole antenna through a Tx cable, and then recorded the maximum Analyzer reading through raised and lowered the test antenna.
 $P_{Mea} = S.G \text{ Level} + \text{Ant-Cable loss}$; $\text{Margin} = P_{Mea} - \text{Limit}$.

TEST SETUP

For radiated test from 30MHz to 1GHz

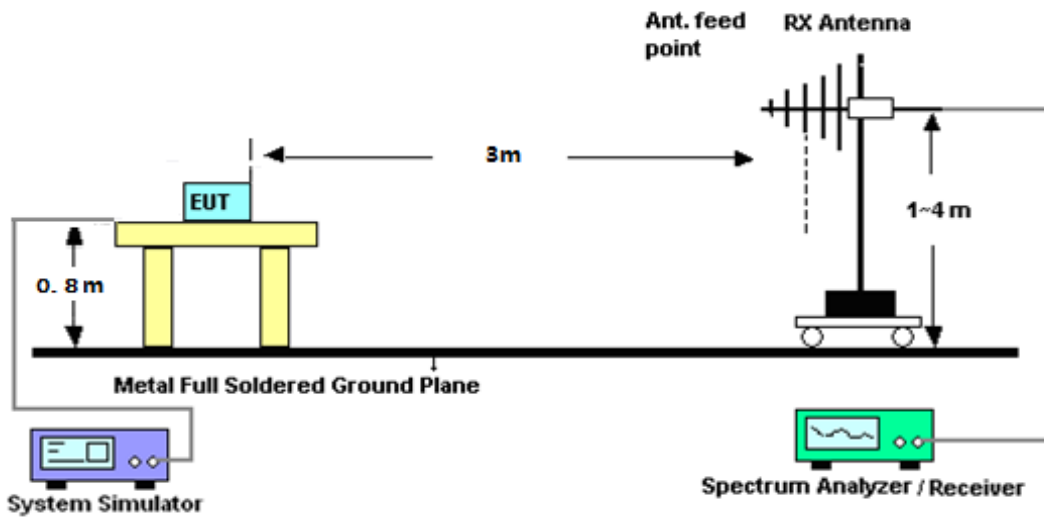

For radiated test from above 1GHz

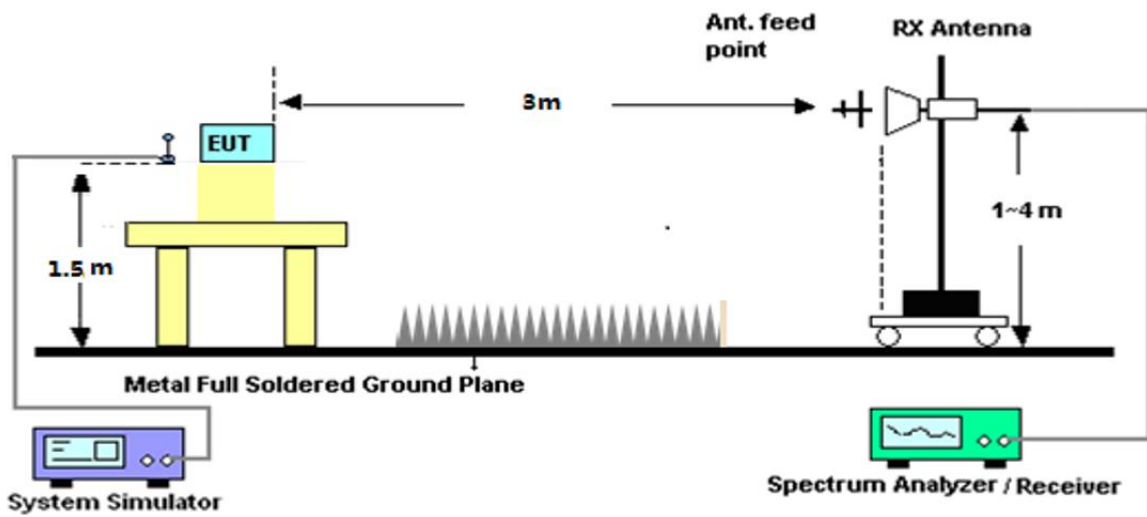

TEST RESULT

Note: Test data See APPENDIX I.

APPENDIX I. TESTRESULT

2G

CONDUCTED OUTPUT POWER

Band	Channel	Frequency (MHz)	Power (dBm)	Gain (dB)	ERP (dBm)	ERP Limit (dBm)	Verdict
GSM850	128	824.2	33.65	0.1	31.6	38.45	PASS
GSM850	190	836.6	33.42	0.1	31.37	38.45	PASS
GSM850	251	848.8	33.74	0.1	31.69	38.45	PASS
GPRS850 1 Slot	128	824.2	33.65	0.1	31.6	38.45	PASS
GPRS850 1 Slot	190	836.6	33.43	0.1	31.38	38.45	PASS
GPRS850 1 Slot	251	848.8	33.78	0.1	31.73	38.45	PASS
GPRS850 2 Slot	128	824.2	31.01	0.1	28.96	38.45	PASS
GPRS850 2 Slot	190	836.6	30.66	0.1	28.61	38.45	PASS
GPRS850 2 Slot	251	848.8	30.76	0.1	28.71	38.45	PASS
GPRS850 3 Slot	128	824.2	29.11	0.1	27.06	38.45	PASS
GPRS850 3 Slot	190	836.6	28.72	0.1	26.67	38.45	PASS
GPRS850 3 Slot	251	848.8	28.83	0.1	26.78	38.45	PASS
GPRS850 4 Slot	128	824.2	27.05	0.1	25	38.45	PASS
GPRS850 4 Slot	190	836.6	26.63	0.1	24.58	38.45	PASS
GPRS850 4 Slot	251	848.8	26.71	0.1	24.66	38.45	PASS
EGPRS850 1 Slot	128	824.2	25.76	0.1	23.71	38.45	PASS
EGPRS850 1 Slot	190	836.6	26.05	0.1	24	38.45	PASS
EGPRS850 1 Slot	251	848.8	25.56	0.1	23.51	38.45	PASS
EGPRS850 2 Slot	128	824.2	24.63	0.1	22.58	38.45	PASS
EGPRS850 2 Slot	190	836.6	24.05	0.1	22	38.45	PASS
EGPRS850 2 Slot	251	848.8	24.62	0.1	22.57	38.45	PASS
EGPRS850 3 Slot	128	824.2	21.59	0.1	19.54	38.45	PASS
EGPRS850 3 Slot	190	836.6	21.88	0.1	19.83	38.45	PASS
EGPRS850 3 Slot	251	848.8	21.84	0.1	19.79	38.45	PASS
EGPRS850 4 Slot	128	824.2	19.39	0.1	17.34	38.45	PASS
EGPRS850 4 Slot	190	836.6	19.31	0.1	17.26	38.45	PASS
EGPRS850 4 Slot	251	848.8	19.8	0.1	17.75	38.45	PASS

Band	Channel	Frequency (MHz)	Power (dBm)	Gain (dB)	ERP (dBm)	EIRP Limit (dBm)	Verdict
GSM1900	512	1850.2	30.8	-0.16	30.2	33.01	PASS
GSM1900	661	1880	30.8	-0.16	30.2	33.01	PASS
GSM1900	810	1909.8	30.41	-0.16	29.81	33.01	PASS
GPRS1900 1 Slot	512	1850.2	30.79	-0.16	30.19	33.01	PASS
GPRS1900 1 Slot	661	1880	30.45	-0.16	29.85	33.01	PASS
GPRS1900 1 Slot	810	1909.8	30.31	-0.16	29.71	33.01	PASS

GPRS1900 2 Slot	512	1850.2	27.04	-0.16	26.44	33.01	PASS
GPRS1900 2 Slot	661	1880	26.95	-0.16	26.35	33.01	PASS
GPRS1900 2 Slot	810	1909.8	26.41	-0.16	25.81	33.01	PASS
GPRS1900 3 Slot	512	1850.2	25.4	-0.16	24.8	33.01	PASS
GPRS1900 3 Slot	661	1880	25.4	-0.16	24.8	33.01	PASS
GPRS1900 3 Slot	810	1909.8	24.83	-0.16	24.23	33.01	PASS
GPRS1900 4 Slot	512	1850.2	23.28	-0.16	22.68	33.01	PASS
GPRS1900 4 Slot	661	1880	23.3	-0.16	22.7	33.01	PASS
GPRS1900 4 Slot	810	1909.8	22.65	-0.16	22.05	33.01	PASS
EGPRS1900 1 Slot	512	1850.2	26.12	-0.16	25.52	33.01	PASS
EGPRS1900 1 Slot	661	1880	26.49	-0.16	25.89	33.01	PASS
EGPRS1900 1 Slot	810	1909.8	26.29	-0.16	25.69	33.01	PASS
EGPRS1900 2 Slot	512	1850.2	24.97	-0.16	24.37	33.01	PASS
EGPRS1900 2 Slot	661	1880	25.05	-0.16	24.45	33.01	PASS
EGPRS1900 2 Slot	810	1909.8	24.26	-0.16	23.66	33.01	PASS
EGPRS1900 3 Slot	512	1850.2	22.29	-0.16	21.69	33.01	PASS
EGPRS1900 3 Slot	661	1880	22.69	-0.16	22.09	33.01	PASS
EGPRS1900 3 Slot	810	1909.8	22.33	-0.16	21.73	33.01	PASS
EGPRS1900 4 Slot	512	1850.2	19.89	-0.16	19.29	33.01	PASS
EGPRS1900 4 Slot	661	1880	20.83	-0.16	20.23	33.01	PASS
EGPRS1900 4 Slot	810	1909.8	19.55	-0.16	18.95	33.01	PASS

FREQUENCY STABILITY

Band	Channel	Frequency (MHz)	Result(Hz)	Result (ppm)	Low Limit (ppm)	high Limit (ppm)	Verdict
GSM850	128	824.2	4.81	0.006	-2.5	2.5	PASS
GSM850	190	836.6	5.65	0.007	-2.5	2.5	PASS
GSM850	251	848.8	-1.65	-0.002	-2.5	2.5	PASS
GPRS850	128	824.2	-2.10	0.00	-2.5	2.5	PASS
GPRS850	190	836.6	9.75	0.01	-2.5	2.5	PASS
GPRS850	251	848.8	11.07	0.01	-2.5	2.5	PASS
EGPRS850	128	824.2	-0.06	0.00	-2.5	2.5	PASS
EGPRS850	190	836.6	4.78	0.01	-2.5	2.5	PASS
EGPRS850	251	848.8	7.39	0.01	-2.5	2.5	PASS
GSM1900	512	1850.2	2.36	0.001	-2.5	2.5	PASS
GSM1900	661	1880	16.30	0.009	-2.5	2.5	PASS
GSM1900	810	1909.8	-3.03	-0.002	-2.5	2.5	PASS
GPRS1900	512	1850.2	-13.85	-0.01	-2.5	2.5	PASS
GPRS1900	661	1880	-1.94	0.00	-2.5	2.5	PASS
GPRS1900	810	1909.8	14.17	0.01	-2.5	2.5	PASS
EGPRS1900	512	1850.2	12.40	0.01	-2.5	2.5	PASS
EGPRS1900	661	1880	9.01	0.00	-2.5	2.5	PASS
EGPRS1900	810	1909.8	14.24	0.01	-2.5	2.5	PASS

PEAK-TO-AVERAGE RATIO

Band	Channel	Frequency (MHz)	Result (dB)	high Limit (dB)	Verdict
GSM850	128	824.2	2.69	13	PASS
GSM850	190	836.6	2.74	13	PASS
GSM850	251	848.8	2.73	13	PASS
GPRS850	128	824.2	2.72	13	PASS
GPRS850	190	836.6	2.78	13	PASS
GPRS850	251	848.8	2.76	13	PASS
EGPRS850	128	824.2	10.60	13	PASS
EGPRS850	190	836.6	9.69	13	PASS
EGPRS850	251	848.8	10.24	13	PASS
GSM1900	512	1850.2	2.78	13	PASS
GSM1900	661	1880	2.79	13	PASS
GSM1900	810	1909.8	2.79	13	PASS
GPRS1900	512	1850.2	2.82	13	PASS
GPRS1900	661	1880	2.83	13	PASS
GPRS1900	810	1909.8	2.83	13	PASS
EGPRS1900	512	1850.2	7.56	13	PASS
EGPRS1900	661	1880	7.17	13	PASS
EGPRS1900	810	1909.8	7.55	13	PASS

GPRS850 Channel=251

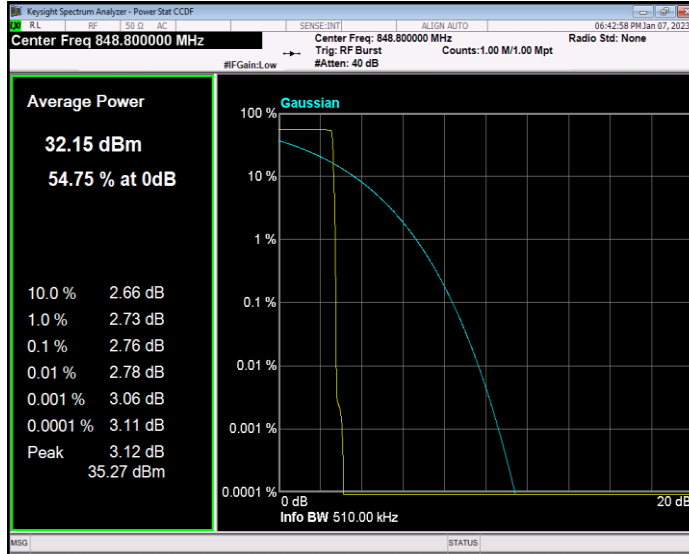

GPRS850 Channel=190

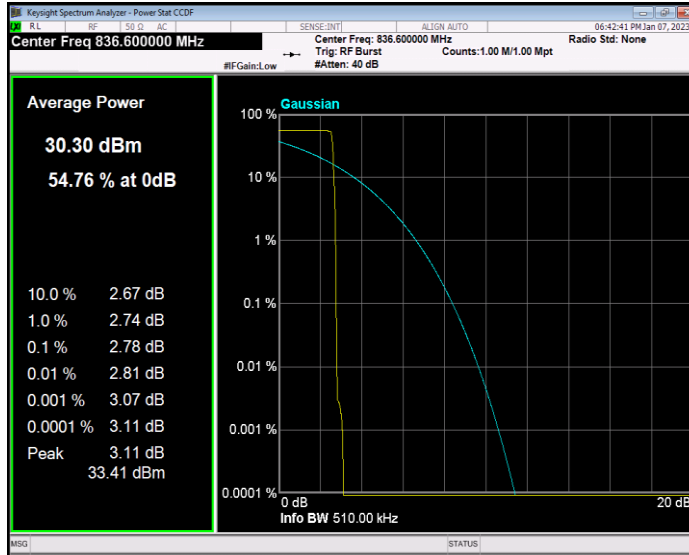

GPRS850 Channel=128

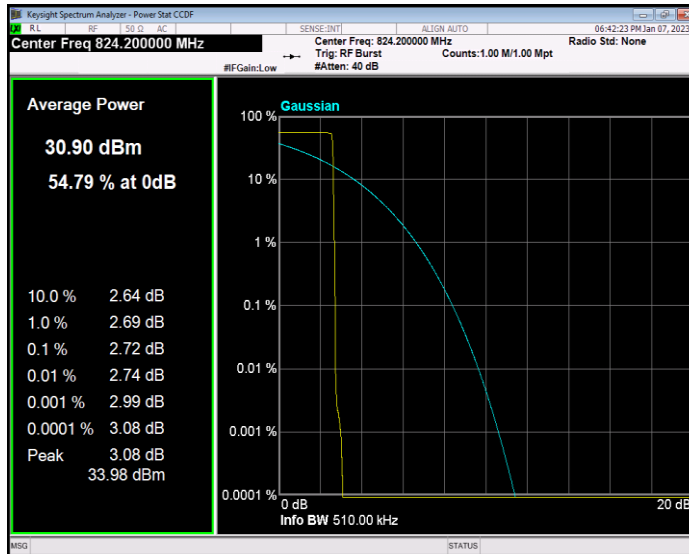

EGPRS850 Channel=128

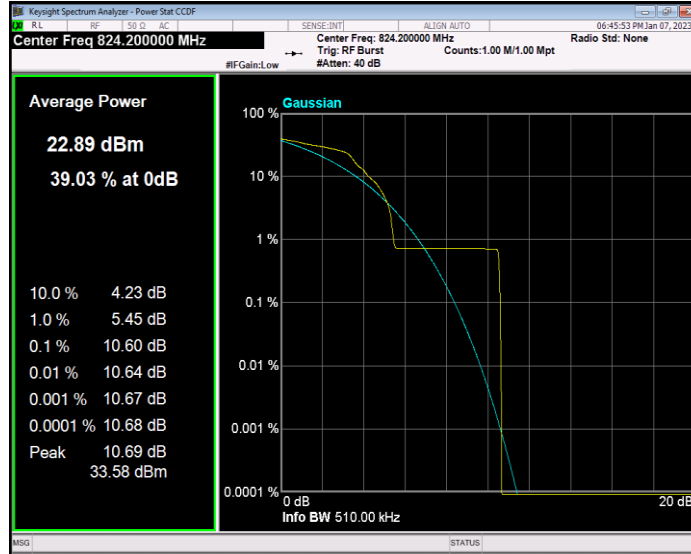

EGPRS850 Channel=190

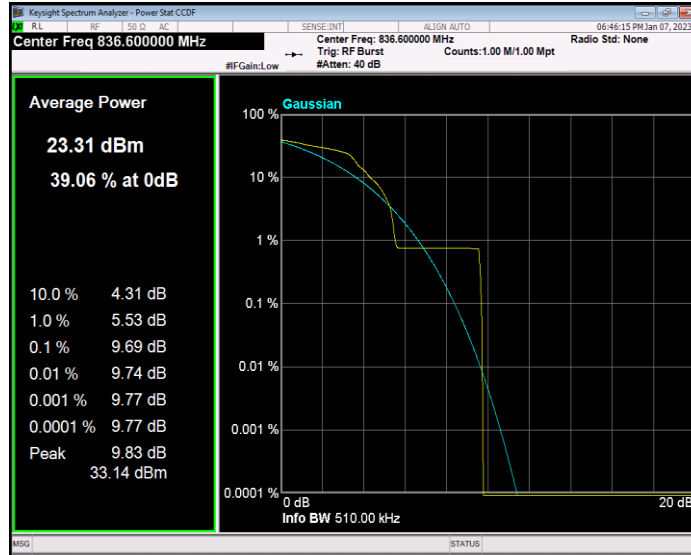

EGPRS850 Channel=251

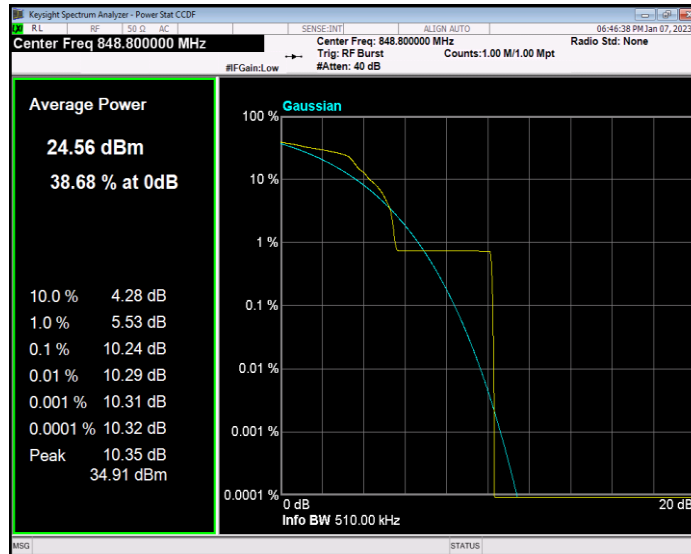

GSM1900 Channel=512

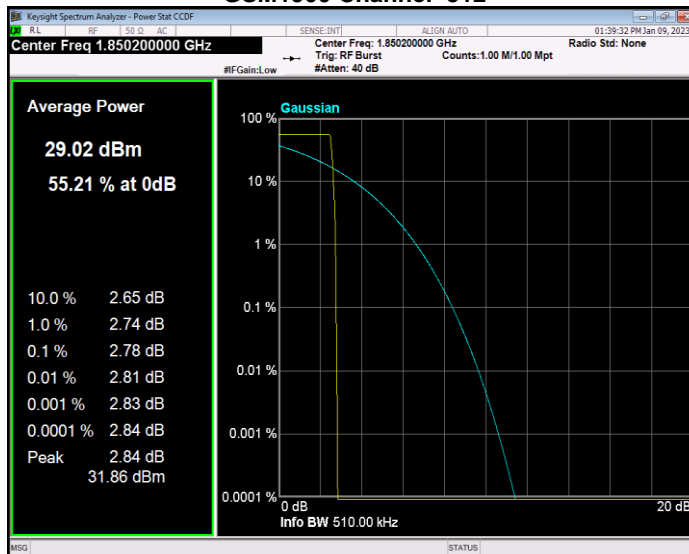

GSM1900 Channel=810

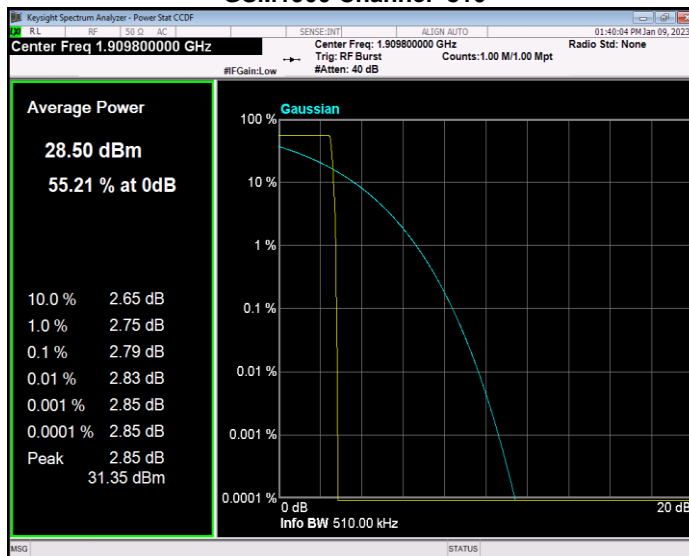

GSM1900 Channel=661

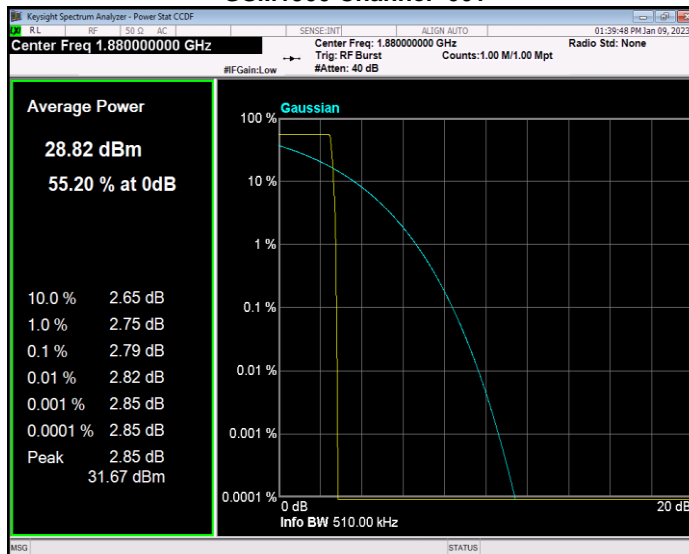

GPRS1900 Channel=810

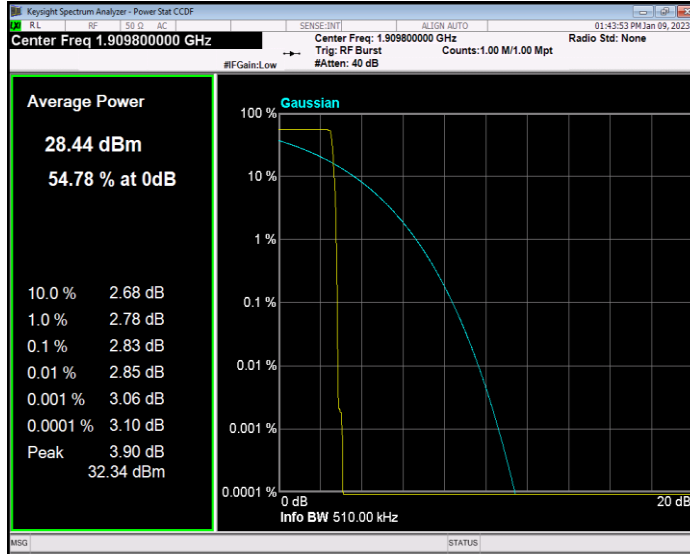

GPRS1900 Channel=661

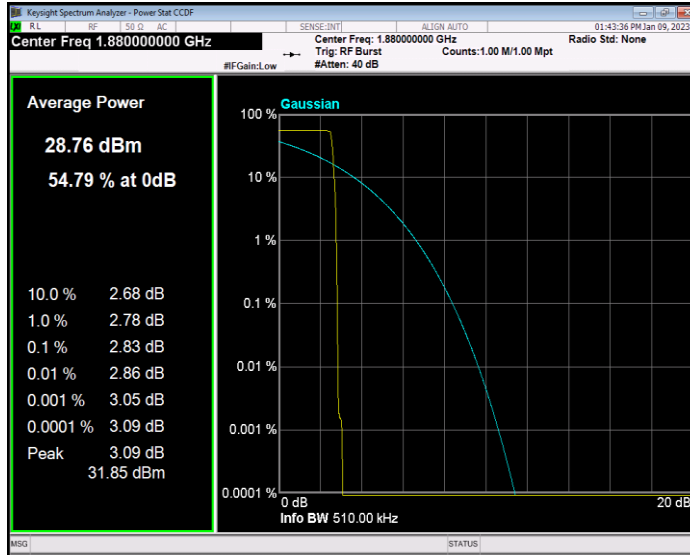

GPRS1900 Channel=512

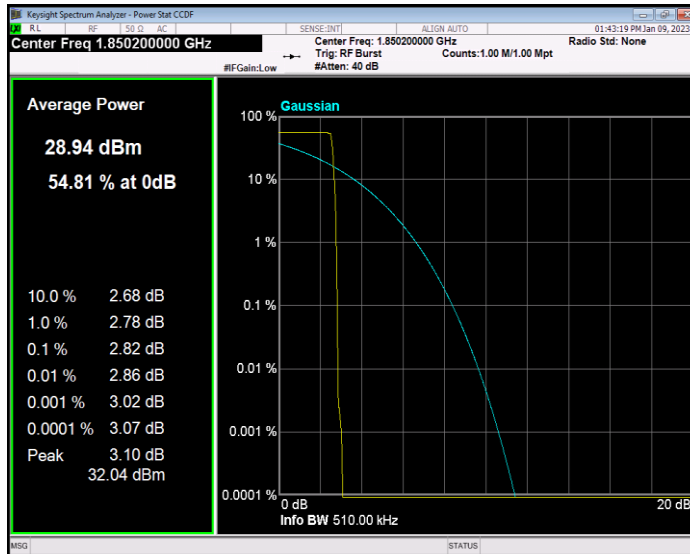

EGPRS1900 Channel=810

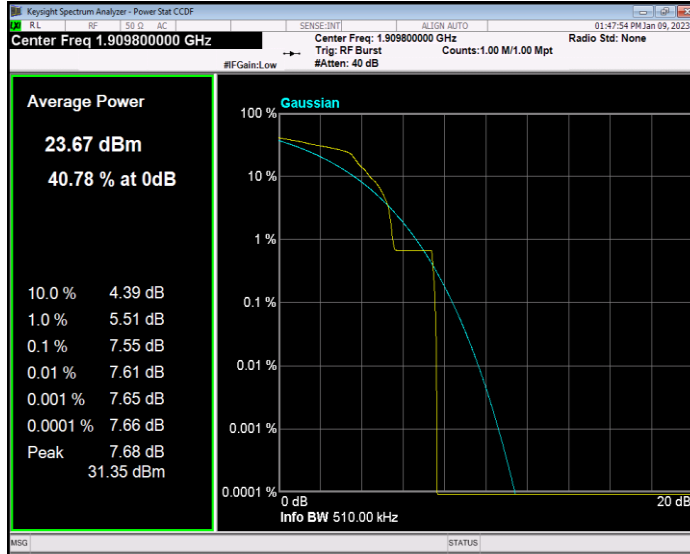

EGPRS1900 Channel=661

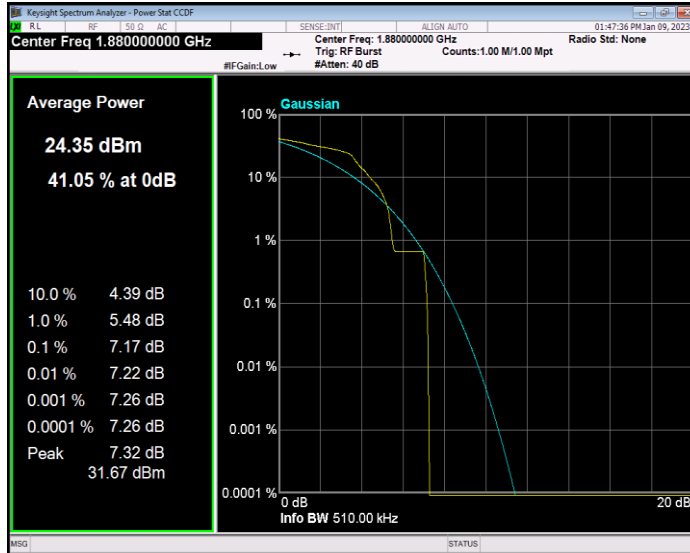

EGPRS1900 Channel=512

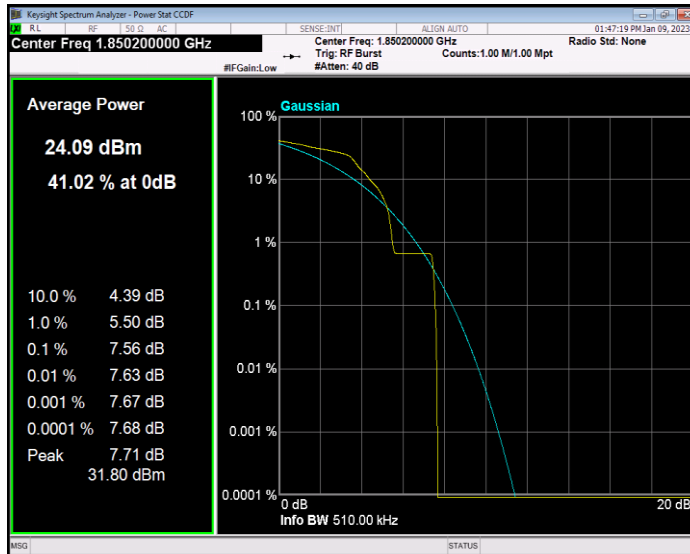

OCCUPIED BANDWIDTH

Band	Channel	Frequency (MHz)	99% OBW (kHz)	-26dB EBW (kHz)	Verdict
GSM850	128	824.2	242.322	314.290	PASS
GSM850	190	836.6	241.260	314.425	PASS
GSM850	251	848.8	244.010	318.563	PASS
GPRS850	128	824.2	241.886	323.440	PASS
GPRS850	190	836.6	245.688	312.220	PASS
GPRS850	251	848.8	243.119	319.342	PASS
EGPRS850	128	824.2	245.412	303.534	PASS
EGPRS850	190	836.6	236.534	298.998	PASS
EGPRS850	251	848.8	236.385	284.478	PASS
GSM1900	512	1850.2	250.931	317.318	PASS
GSM1900	661	1880	243.402	320.897	PASS
GSM1900	810	1909.8	245.668	317.874	PASS
GPRS1900	512	1850.2	245.623	319.642	PASS
GPRS1900	661	1880	251.391	313.245	PASS
GPRS1900	810	1909.8	245.046	314.349	PASS
EGPRS1900	512	1850.2	247.200	318.082	PASS
EGPRS1900	661	1880	250.827	315.407	PASS
EGPRS1900	810	1909.8	239.709	309.068	PASS

GSM850 Channel=251

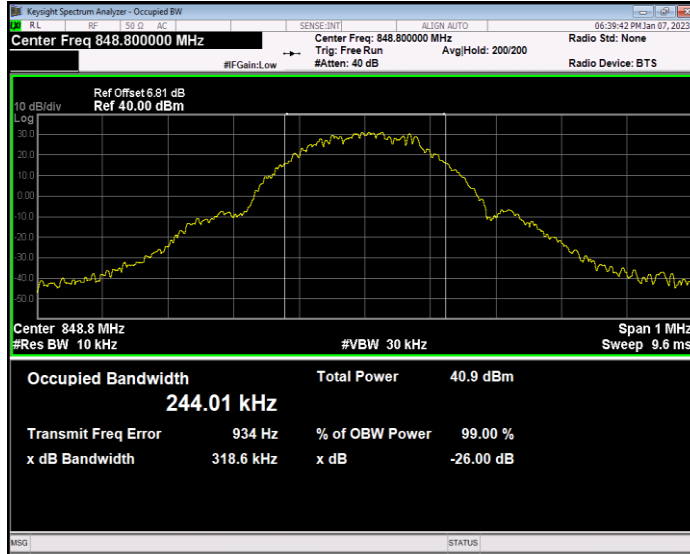

GSM850 Channel=190

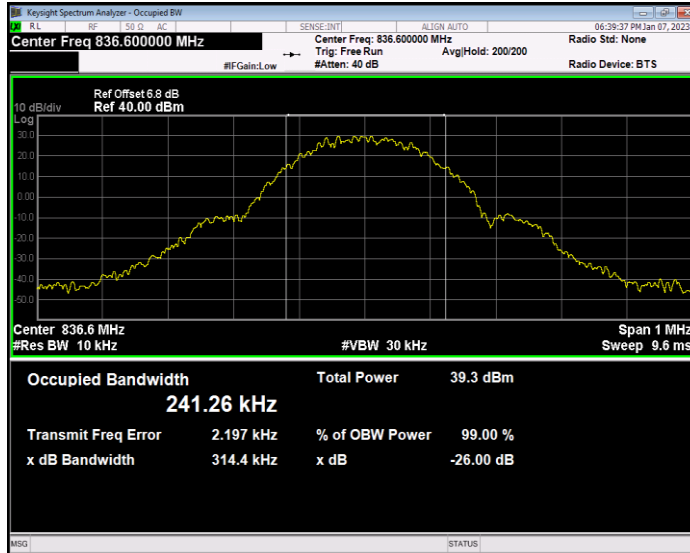

GSM850 Channel=128

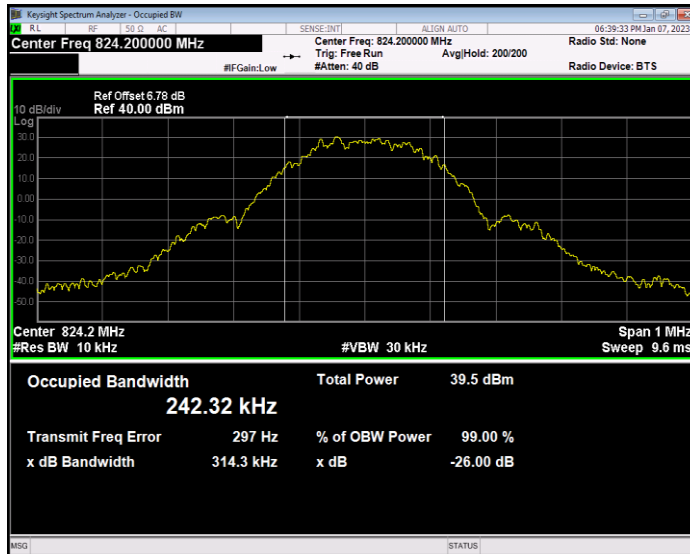

GPRS850 Channel=190

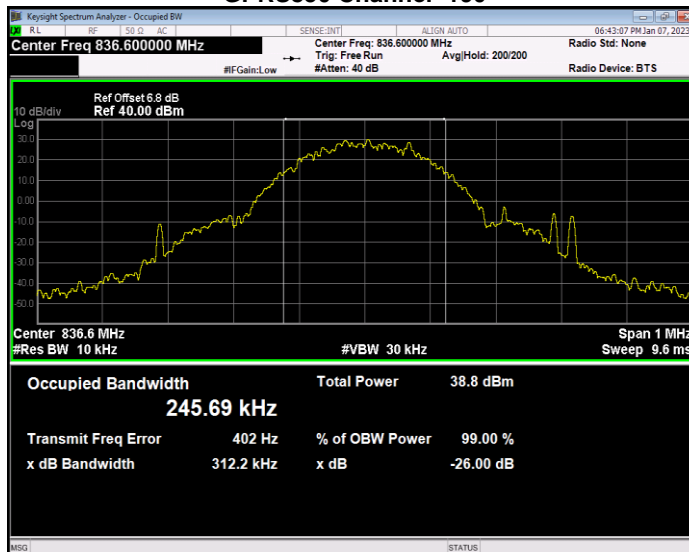

GPRS850 Channel=128

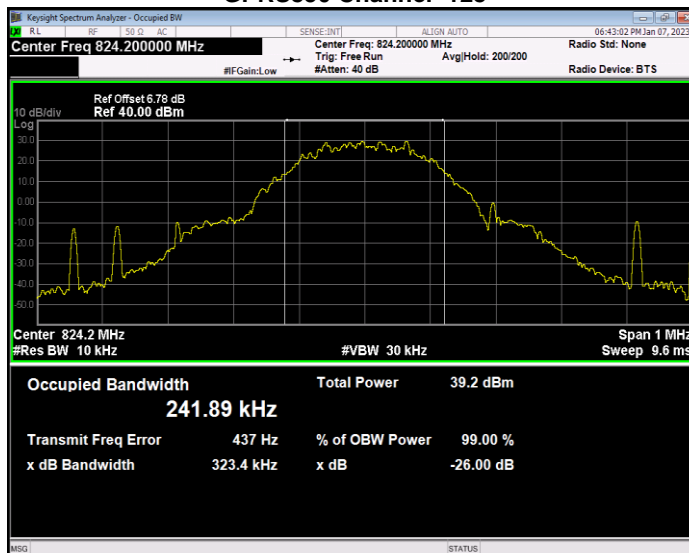

GPRS850 Channel=251

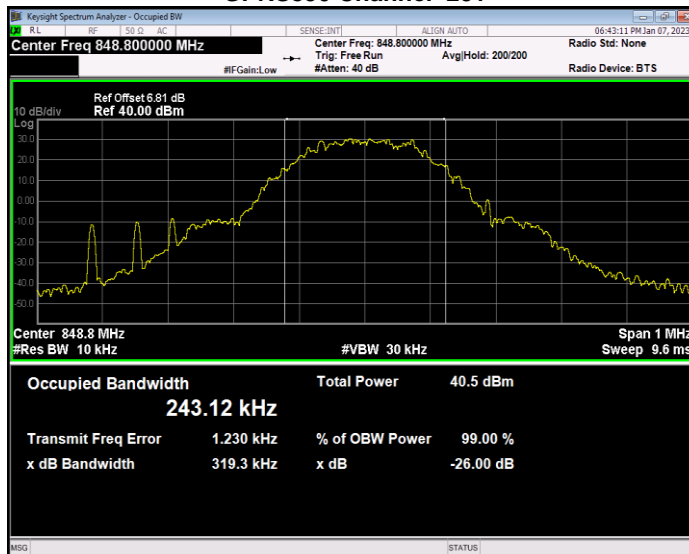

EGPRS850 Channel=128

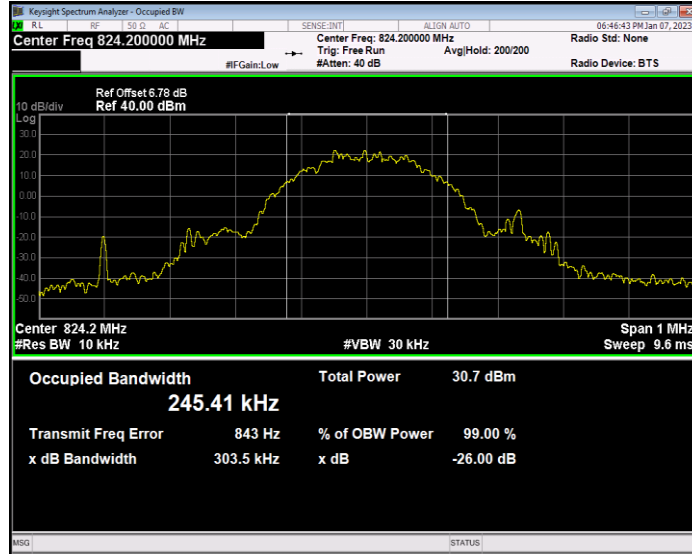

EGPRS850 Channel=190

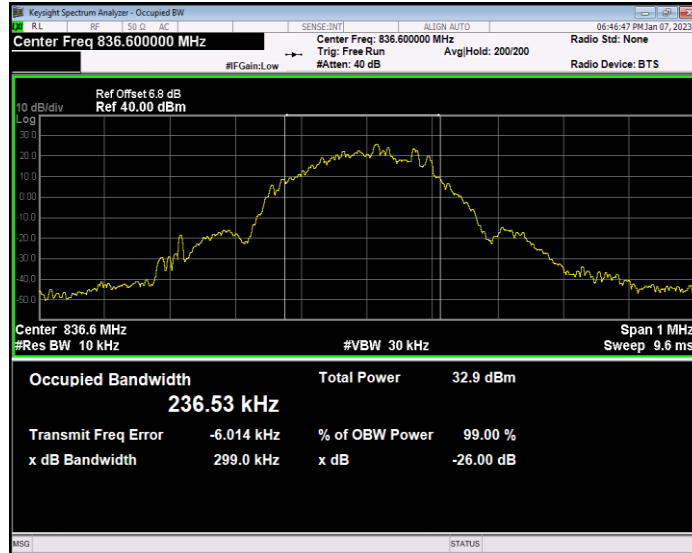

EGPRS850 Channel=251

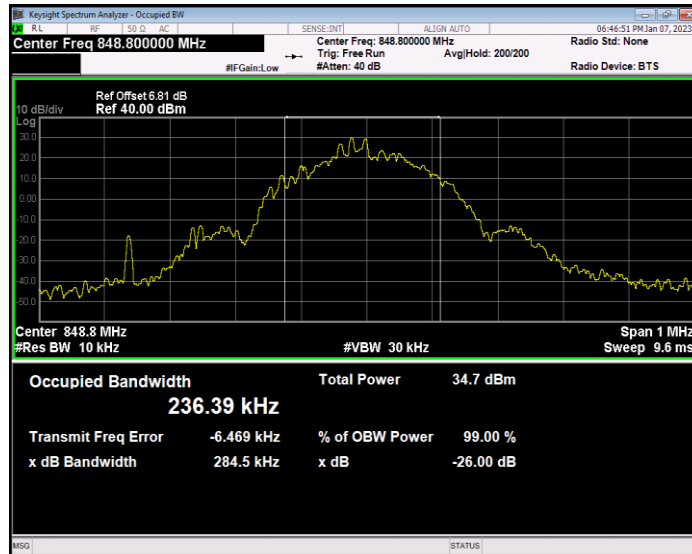

GSM1900 Channel=810

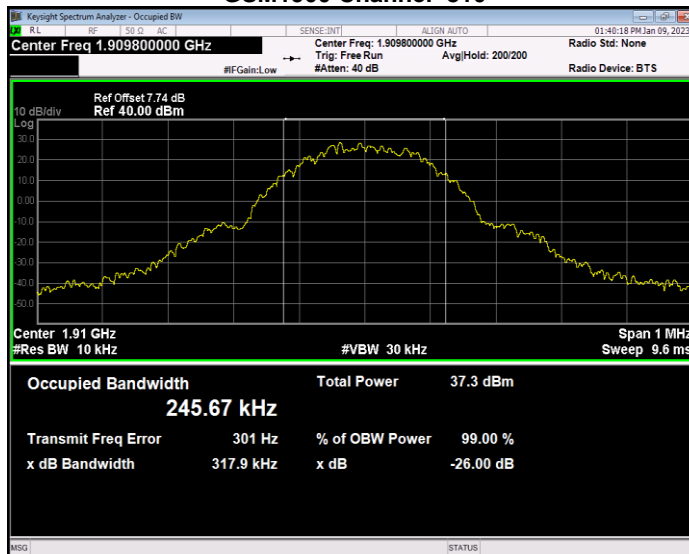

GSM1900 Channel=661

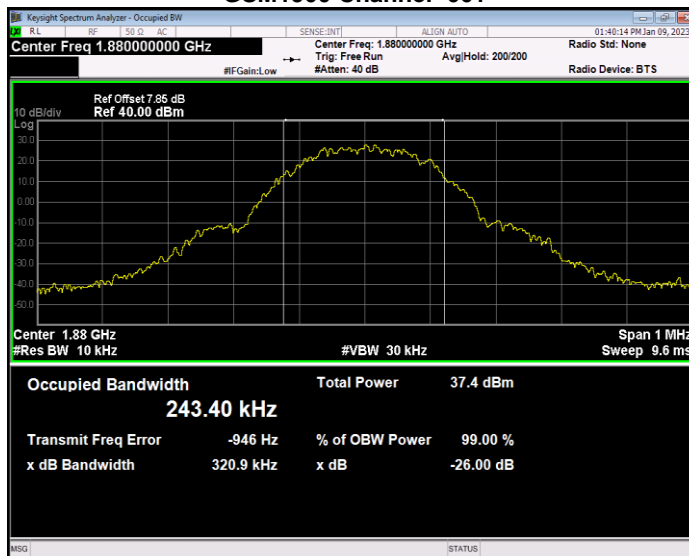

GSM1900 Channel=512

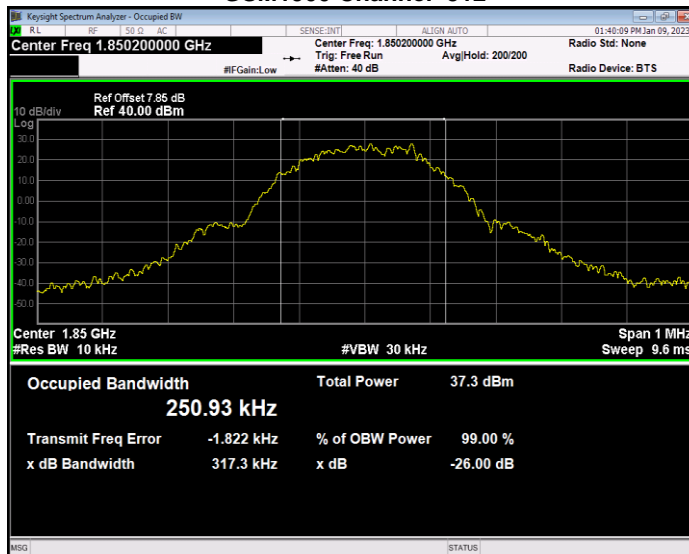

GPRS1900 Channel=810

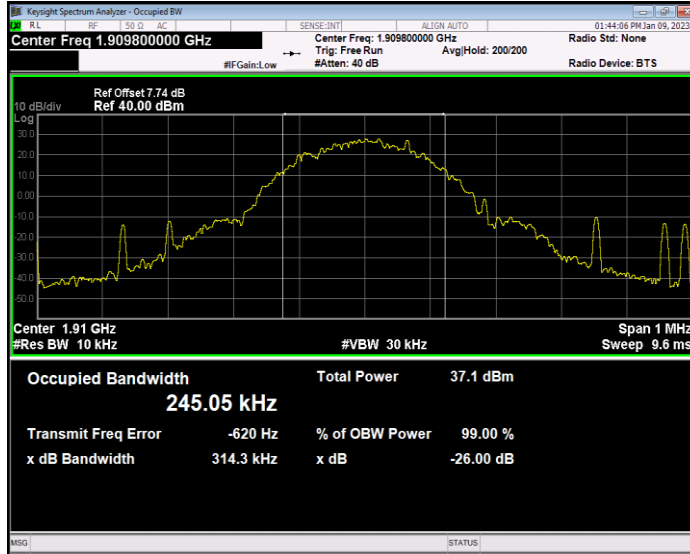

GPRS1900 Channel=661

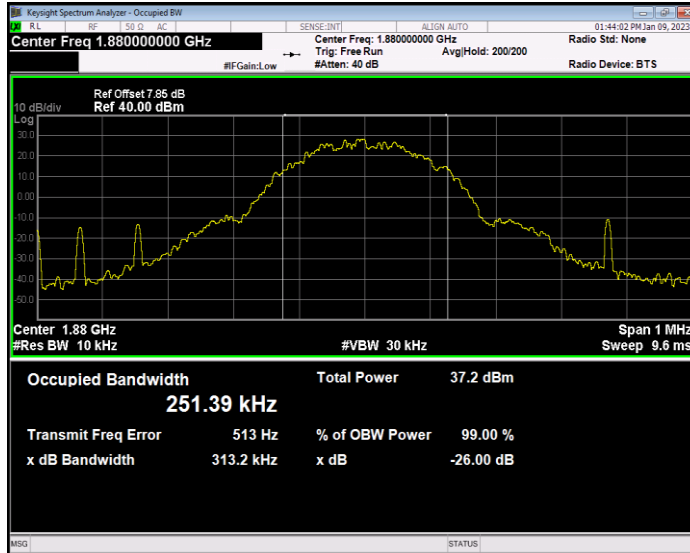

GPRS1900 Channel=512

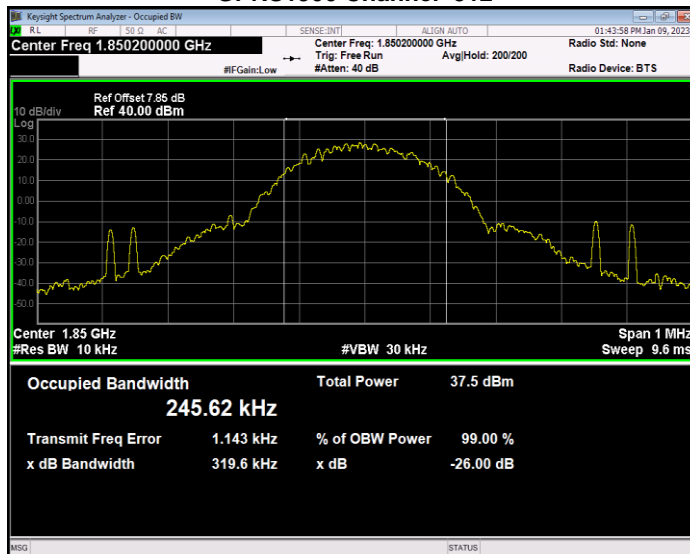

EGPRS1900 Channel=512

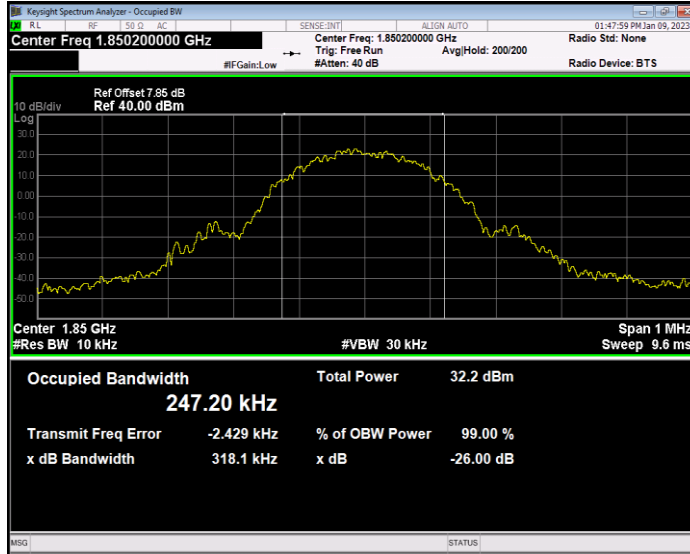

EGPRS1900 Channel=810

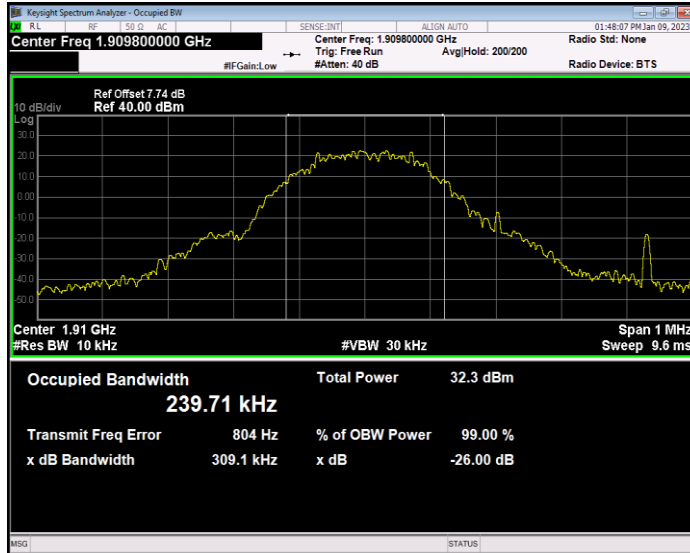

EGPRS1900 Channel=661

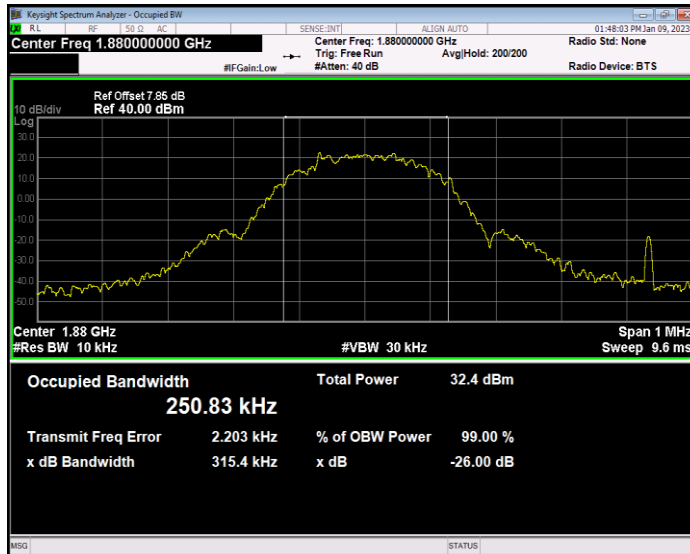

BAND EDGE

Band	Channel	Frequency (MHz)	Spur Freq (MHz)	Spur Level (dBm)	Limit (dBm)	Verdict
GSM850	128	824.2	823.98	-28.21	-13	PASS
GSM850	251	848.8	849.02	-25.66	-13	PASS
GPRS850	128	824.2	823.98	-27.10	-13	PASS
GPRS850	251	848.8	849.03	-26.79	-13	PASS
EGPRS850	128	824.2	823.99	-35.50	-13	PASS
EGPRS850	251	848.8	849.00	-34.23	-13	PASS
GSM1900	512	1850.2	1850.00	-28.70	-13	PASS
GSM1900	810	1909.8	1910.02	-29.29	-13	PASS
GPRS1900	512	1850.2	1849.98	-30.06	-13	PASS
GPRS1900	810	1909.8	1910.02	-30.36	-13	PASS
EGPRS1900	512	1850.2	1849.98	-35.92	-13	PASS
EGPRS1900	810	1909.8	1910.02	-36.07	-13	PASS

GSM850 Channel=128

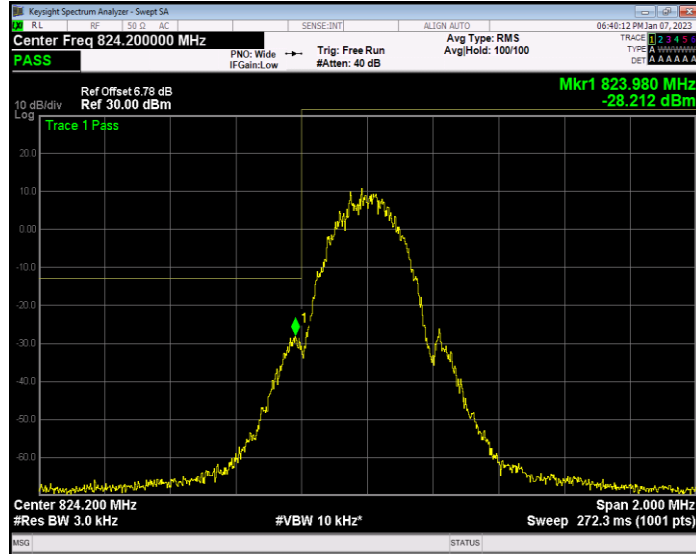

GSM850 Channel=251

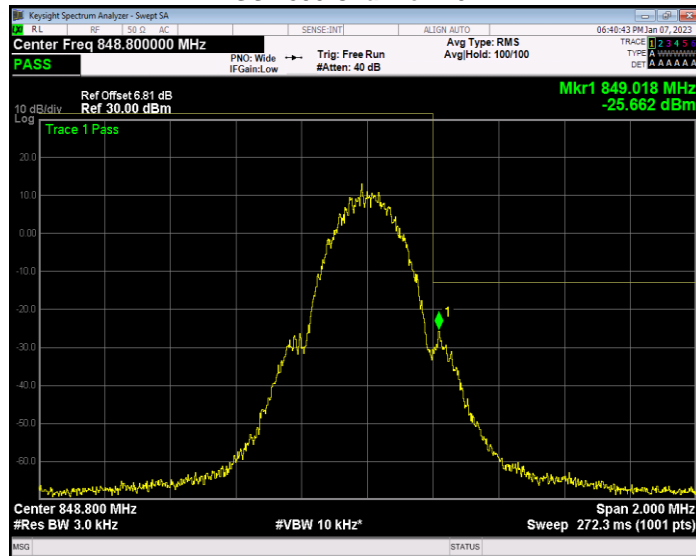

GPRS850 Channel=251

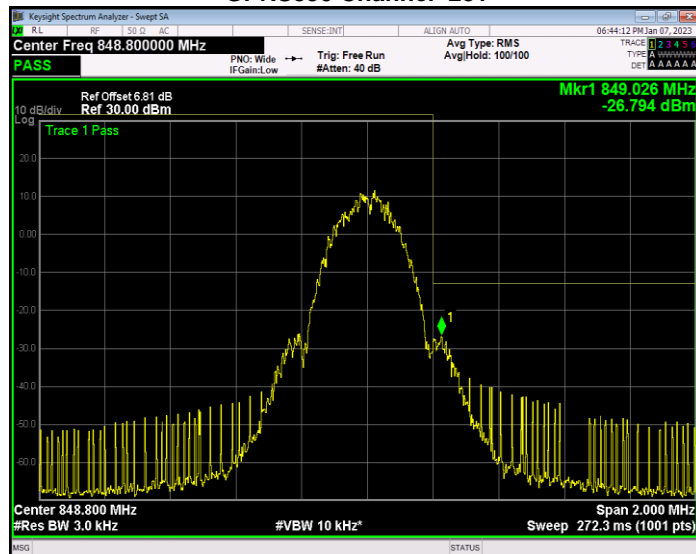

GPRS850 Channel=128

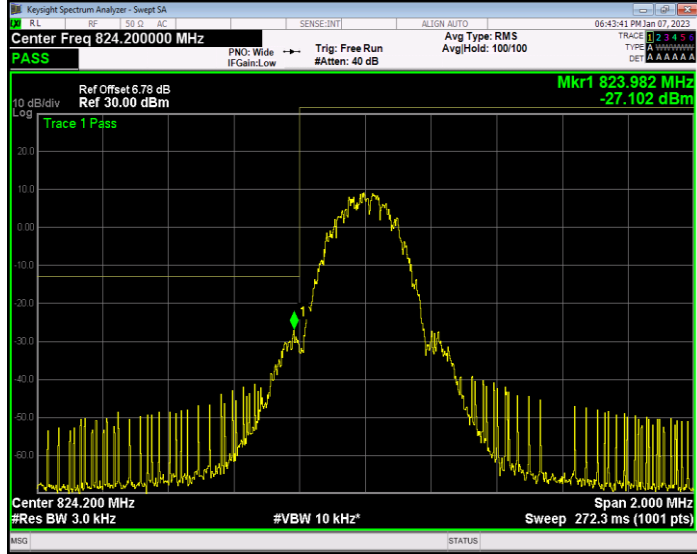

EGPRS850 Channel=251

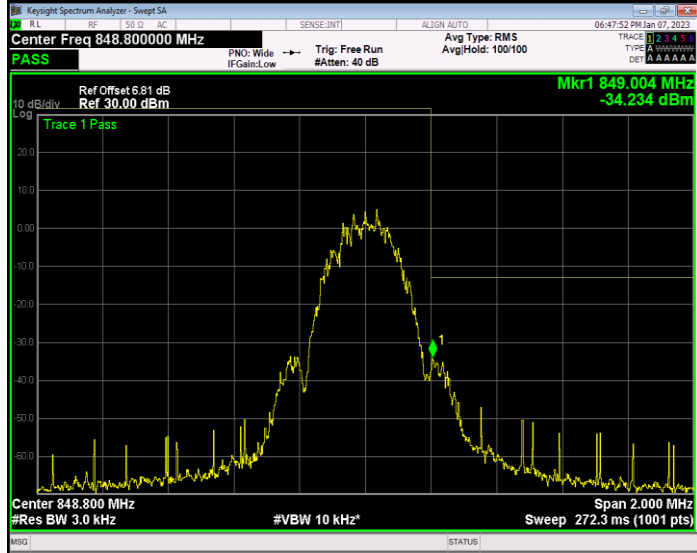

EGPRS850 Channel=128

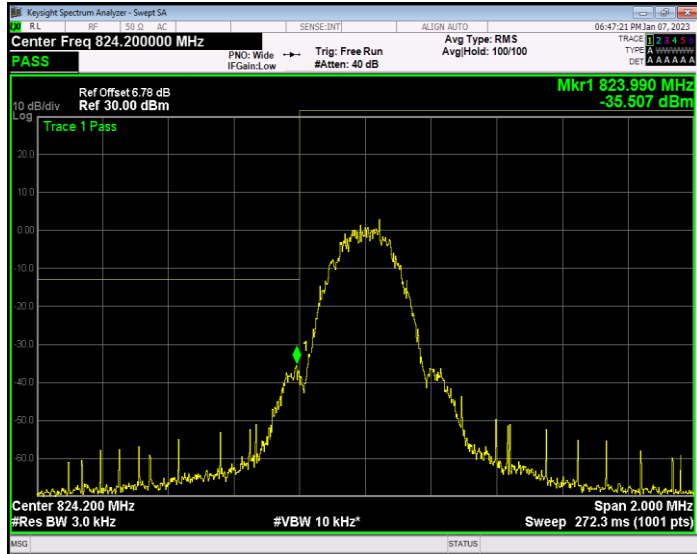

GSM1900 Channel=512

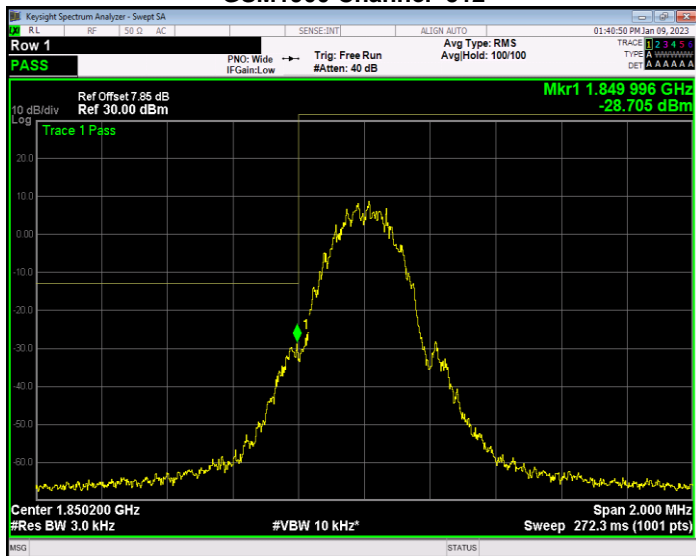

GSM1900 Channel=810

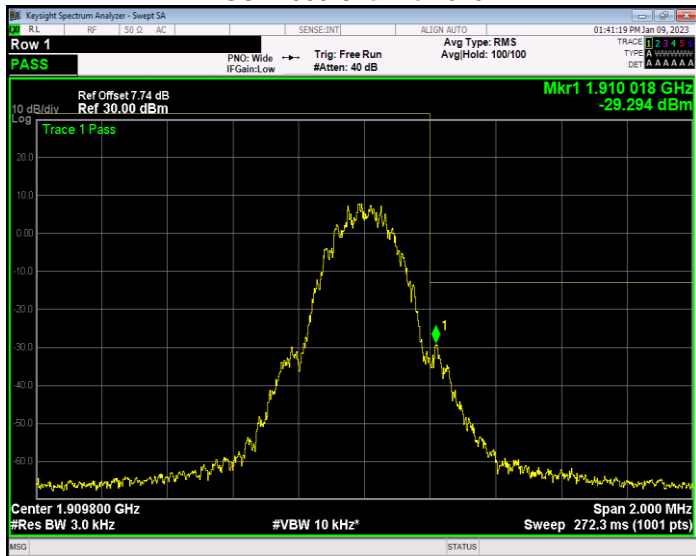

GPRS1900 Channel=810

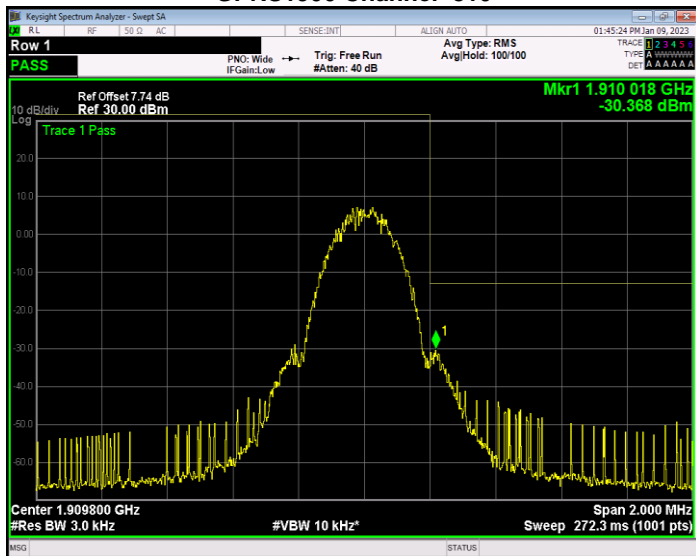

GPRS1900 Channel=512

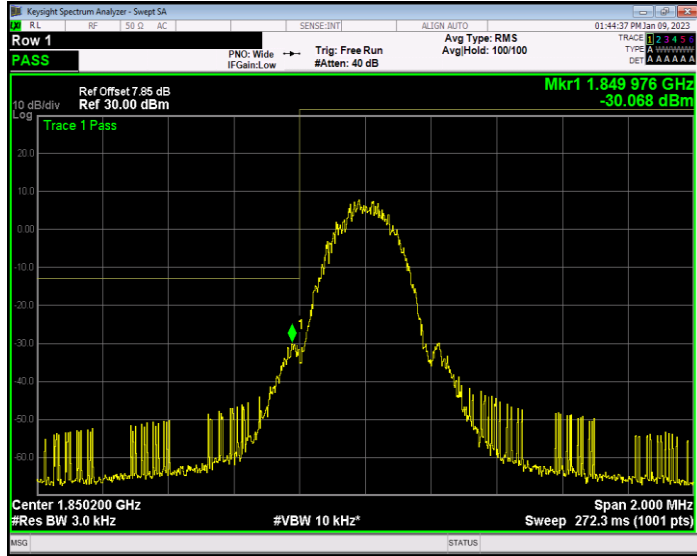

EGPRS1900 Channel=512

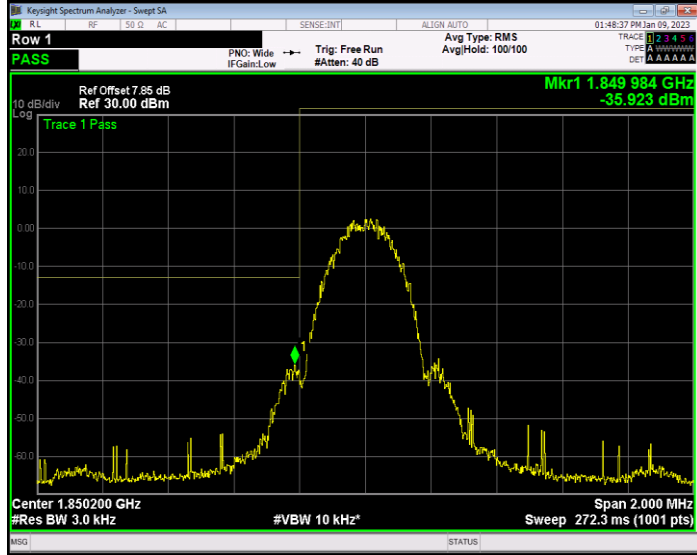

EGPRS1900 Channel=810

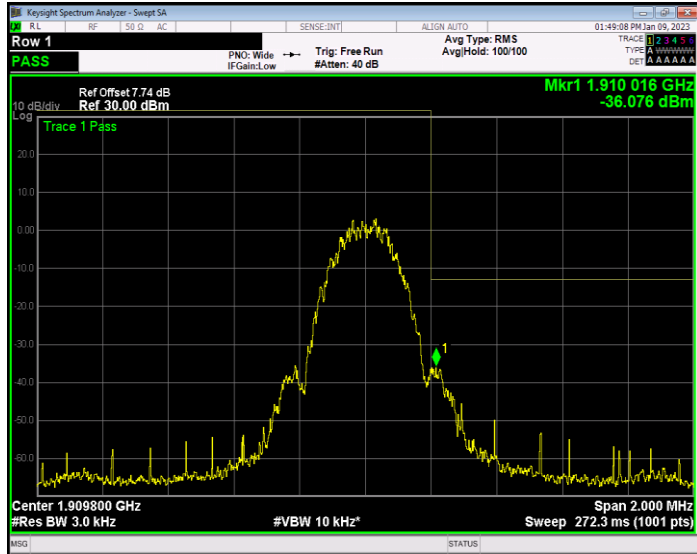

OUT-OF-BAND EMISSIONS

Band	Channel	Frequency (MHz)	Spur Freq (MHz)	Spur Level (dBm)	Limit (dBm)	Verdict
GSM850	128	824.2	3174.29	-29.86	-13	PASS
GSM850	190	836.6	3144.38	-29.59	-13	PASS
GSM850	251	848.8	2665.07	-28.36	-13	PASS
GSM850	128	824.2	3177.03	-29.62	-13	PASS
GPRS850	190	836.6	3321.84	-29.79	-13	PASS
GPRS850	251	848.8	3298.91	-29.33	-13	PASS
EGPRS850	128	824.2	3049.17	-29.67	-13	PASS
EGPRS850	190	836.6	3173.54	-29.19	-13	PASS
EGPRS850	251	848.8	7426.99	-30.07	-13	PASS
GSM1900	512	1850.2	19985.02	-21.81	-13	PASS
GSM1900	661	1880	19939.59	-22.33	-13	PASS
GSM1900	810	1909.8	19354.47	-22.56	-13	PASS
GPRS1900	512	1850.2	16475.30	-21.86	-13	PASS
GPRS1900	661	1880	16399.41	-21.77	-13	PASS
GPRS1900	810	1909.8	19968.55	-22.03	-13	PASS
EGPRS1900	512	1850.2	19721.92	-22.39	-13	PASS
EGPRS1900	661	1880	16473.30	-21.77	-13	PASS
EGPRS1900	810	1909.8	19495.76	-22.87	-13	PASS

GSM850 Channel=128

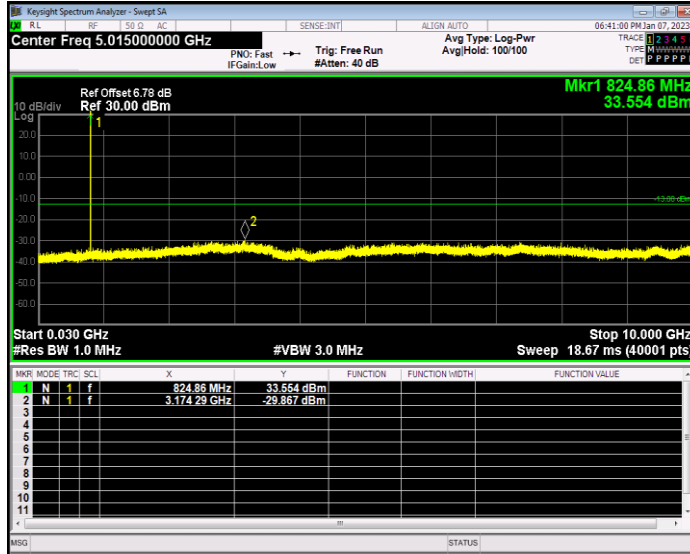

GSM850 Channel=190

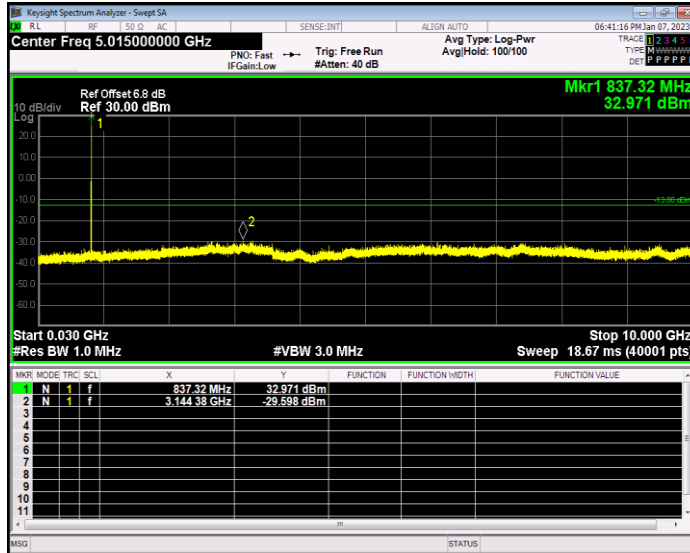

GSM850 Channel=251

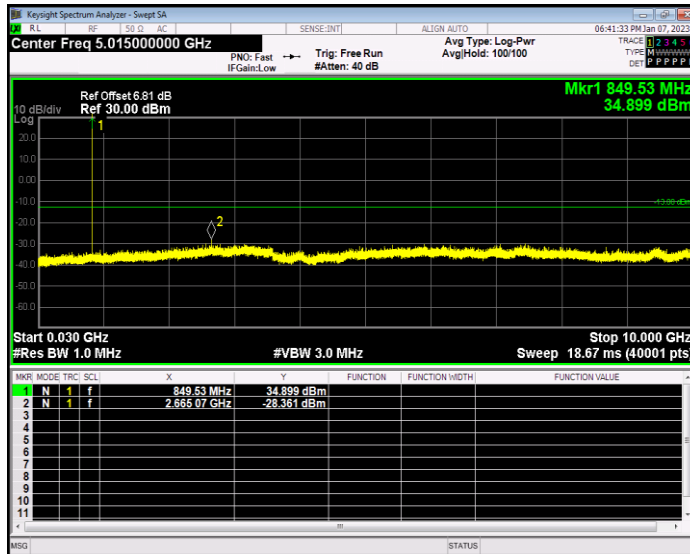

GPRS850 Channel=128

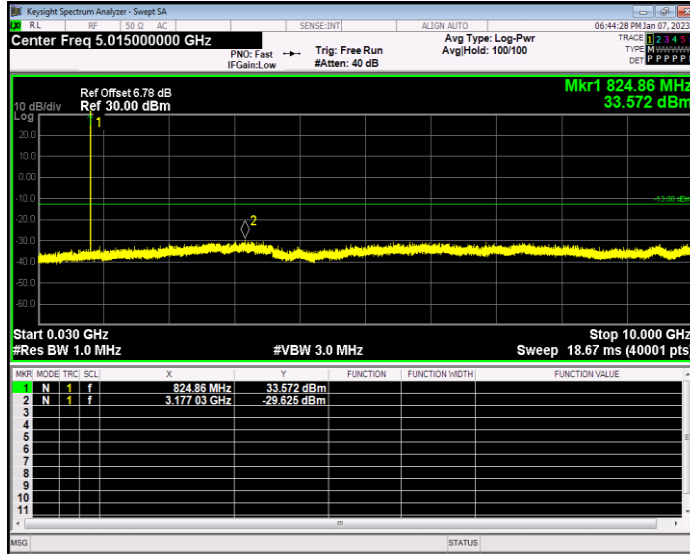

GPRS850 Channel=190

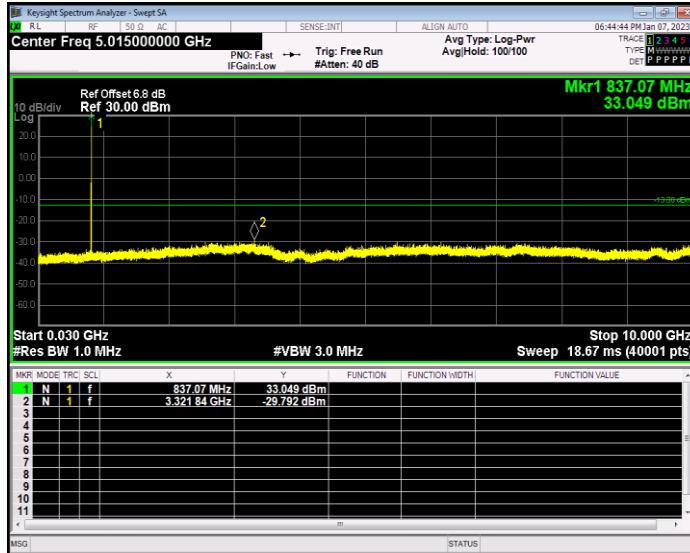

GPRS850 Channel=251

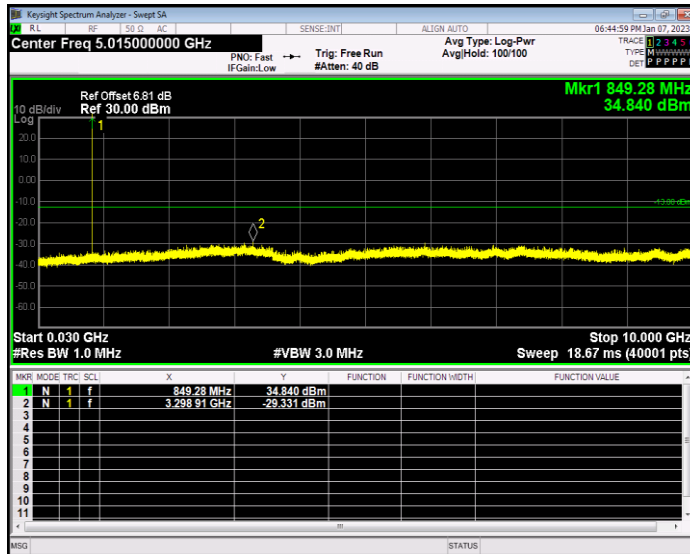

EGPRS850 Channel=251

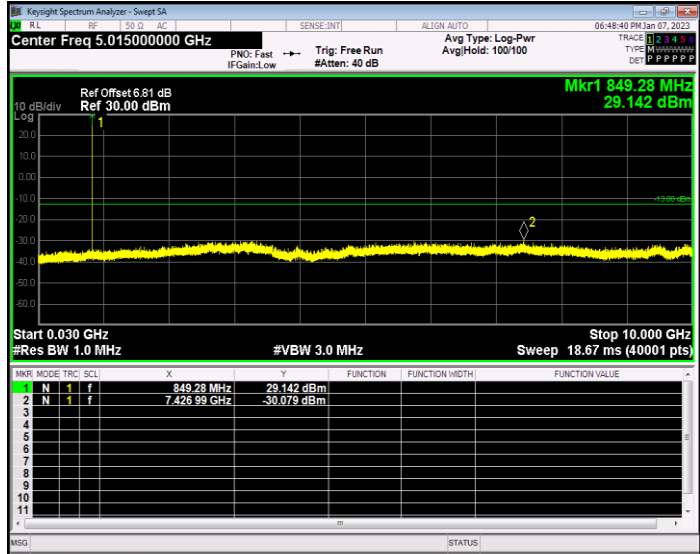

EGPRS850 Channel=190

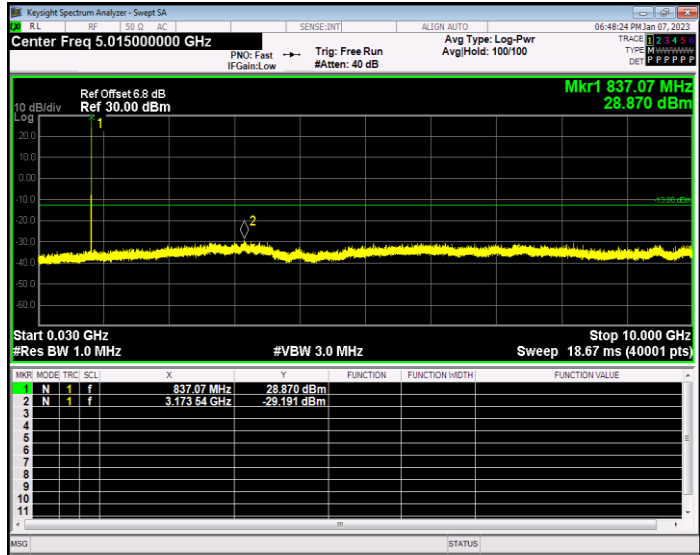

EGPRS850 Channel=128

