



# TEST REPORT

## FCC ID: 2A9Q9-M1026Q

Applicant: ShenZhen Zhongyi Technology CO., Ltd.  
Address: Room 401, No.4 Road One, Shangxue Science and Technology City, Xinxue Community, Bantian Street, Longgang District, Shenzhen, China  
Manufacturer: ShenZhen Zhongyi Technology CO., Ltd.  
Address: Room 401, No.4 Road One, Shangxue Science and Technology City, Xinxue Community, Bantian Street, Longgang District, Shenzhen, China  
EUT: Legion 3-in-1 Charging Station  
Trade Mark: N/A  
Model Number: M1026Q-A  
EAC-LG23  
Date of Receipt: May. 18, 2023  
Test Date: May. 18, 2023 - May. 24, 2023  
Date of Report: May. 24, 2023  
Prepared By: Shenzhen DL Testing Technology Co., Ltd.  
Address: 101-201, Building C, Shuanghuan, No.8, Baoqing Road, Baolong Industrial Zone, Baolong Street, Longgang District, Shenzhen, Guangdong, China  
Applicable Standards: FCC PART 15 Subpart C  
ANSI C63.10:2013  
Test Result: Pass  
Report Number: DL-20230524016E

Prepared (Engineer): Lily Fu  
Reviewer (Supervisor): Jack Bu  
Approved (Manager): Jade Yang



*This test report is based on a single evaluation of one sample of above mentioned products. It is not permitted to be duplicated in extracts without written approval of Shenzhen DL Testing Technology Co., Ltd.*



**TABLE OF CONTENT**

	Page
Test Report Declaration	
<b>1. VERSION .....</b>	<b>3</b>
<b>2. TEST SUMMARY .....</b>	<b>3</b>
<b>3. GENERAL INFORMATION .....</b>	<b>4</b>
<b>4. TEST INSTRUMENT USED .....</b>	<b>6</b>
<b>5. CONDUCTED EMISSION TEST .....</b>	<b>7</b>
<b>6. RADIATION EMISSION TEST .....</b>	<b>11</b>
<b>7. BANDWIDTH TEST .....</b>	<b>17</b>
<b>8. SETUP PHOTOGRAPHS .....</b>	<b>19</b>
<b>9. EUT PHOTOGRAPHS .....</b>	<b>19</b>

**1. VERSION**

Version No.	Date	Description
00	May. 24, 2023	Original

**2. TEST SUMMARY**

EMC Emission			
Test Item	Section in CFR 47	Result	Remark
AC Power Line Conducted Emission	15.207	PASS	
Spurious Emission	15.209(a)(f)	PASS	
20dB Bandwidth	15.215	PASS	
Antenna requirement	15.203	PASS	

**NOTE:**

(1) "N/A" denotes test is not applicable in this Test Report

(2) Test Facility: Shenzhen DL Testing Technology Co., Ltd.

Address: 101-201, Building C, Shuanghuan, No.8, Baoqing Road, Baolong Industrial Zone,  
Baolong Street, Longgang District, Shenzhen, Guangdong, China



3. GENERAL INFORMATION

3.1 Description of Device (EUT)

Product Name: Legion 3-in-1 Charging Station  
 Trade Mark: N/A  
 Model No.: M1026Q-A  
 EAC-LG23  
 Model Difference: The product's different for model number and appearance color.  
 Serial No.: N/A  
 Hardware version: H1.0  
 Software version: S1.0  
 Operation Frequency: 115kHz ~ 205KHz  
 Modulation type: MSK  
 Antenna Type: Inductive loop coil Antenna  
 Antenna gain: 0dBi  
 Power supply: Type C Input: DC 5V/3A, 9V/2A, 12V/1.5A  
 Wireless Charging Output (Stand): 5W, 7.5W, 10W, 15W (Max)  
 Wireless Charging Output (Base): 5W  
 Wireless Charging Output (Watch): 2W

3.2 Tested System Details

None.

3.3 Block Diagram of Test Set-up

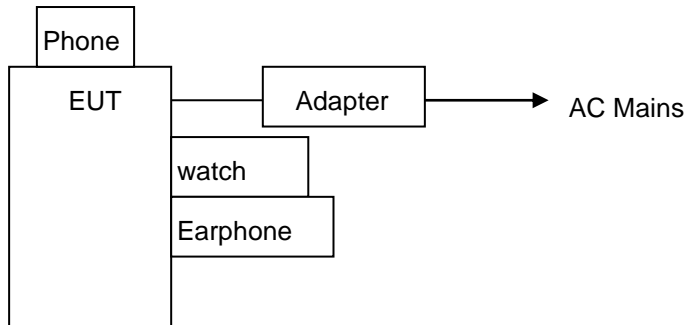

3.4 Test Mode Description

- Mode1. Phone+Earphone Mode
- Mode2. Iwatch+Earphone Mode
- Mode3. Phone+Iwatch Mode
- Mode4. Phone+Earphone+Iwatch Mode

Note: We have evaluated 1%, 50% and 99% battery charging mode, and the worst mode (99%) is showed in this report.



### 3.5 Test Auxiliary Equipment

Adapter (Provide by test lab):  
Manufacturer: XIAOMI  
Model: AD65G  
I/P: AC 100-240V 50/60Hz  
O/P: DC 5V/3A, DC 9V/3A, DC 10V/5A, DC 12V/3A,  
DC 15V/3A, DC 20V/3.25A

Mobile phone (Provide by test lab):  
Manufacturer: SAMSUNG  
Model: Galaxy S21 5G

Watch (Provide by test lab):  
Manufacturer: Apple  
Model: Series 6

Headset (Provide by test lab):  
Manufacturer: Apple  
Model: AirPods Pro

### 3.6 Test Uncertainty

Conducted Emission Uncertainty(150KHz-30MHz)	:	±2.56dB
20dB Bandwidth	:	±0.5kHz
Radiated Emission Uncertainty(9KHz-1GHz)	:	±3.24dB

**4. TEST INSTRUMENT USED****For Conducted Emission Test (843 Shielded Room)**

Equipment	Manufacturer	Model	Serial	Last Cal.	Next Cal.
843 Shielded Room	ChengYu	843 Room	843	Sep. 20, 2022	Sep. 19, 2025
EMI Receiver	R&S	ESR	101421	Nov. 05, 2022	Nov. 04, 2023
LISN	R&S	ENV216	102417	Nov. 05, 2022	Nov. 04, 2023
Clamp	COM-POWER	CLA-050	431071	Nov. 05, 2022	Nov. 04, 2023
3-Loop Antenna	DAZE	ZN30401	13021	Nov. 05, 2022	Nov. 04, 2023
ISN T8	Schwarzbeck	NTFM 8158	101135	Nov. 05, 2022	Nov. 04, 2023
ISN T5	Schwarzbeck	NTFM 8158	101136	Nov. 05, 2022	Nov. 04, 2023
843 Cable 1#	ChengYu	CE Cable	001	Nov. 05, 2022	Nov. 04, 2023
843 Cable 1#	ChengYu	CE Cable	002	Nov. 05, 2022	Nov. 04, 2023

**For Radiated Emission Test (966 chamber)**

Equipment	Manufacturer	Model	Serial	Last Cal.	Next Cal.
966 Chamber	ChengYu	966 Room	966	Sep. 20, 2022	Sep. 19, 2025
Spectrum Analyzer	Agilent	E4408B	MY50140780	Nov. 05, 2022	Nov. 04, 2023
EMI Receiver	R&S	ESRP7	101393	Nov. 05, 2022	Nov. 04, 2023
Amplifier	Schwarzbeck	BBV9743B	00153	Nov. 05, 2022	Nov. 04, 2023
Amplifier	EMEC	EM01G8GA	00270	Nov. 05, 2022	Nov. 04, 2023
Broadband Trilog Antenna	Schwarzbeck	VULB9162	00306	Nov. 05, 2022	Nov. 04, 2023
Horn Antenna	Schwarzbeck	BBHA9120D	02139	Nov. 05, 2022	Nov. 04, 2023
Loop Antenna	ZHINAN	ZN30900A	/	Nov. 05, 2022	Nov. 04, 2023
966 Cable 1#	ChengYu	966	004	Nov. 05, 2022	Nov. 04, 2023
966 Cable 2#	ChengYu	966	003	Nov. 05, 2022	Nov. 04, 2023

**5. CONDUCTED EMISSION TEST**

5.1 Block Diagram of Test Setup

**For Mains Terminals Test**

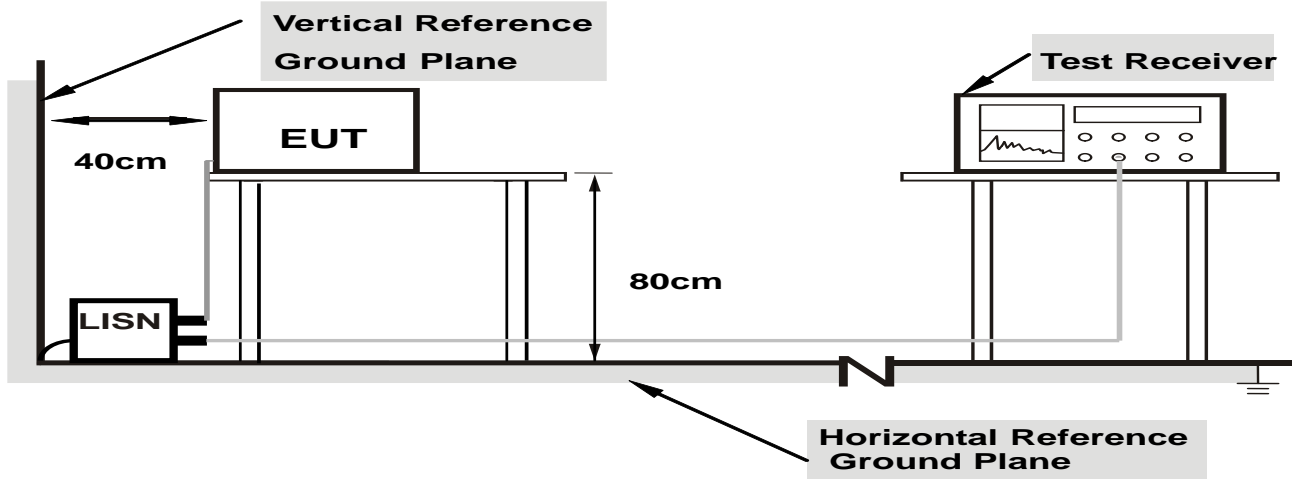

- Note:**
1. Support units were connected to second LISN.
  2. Both of LISNs (AMN) are 80 cm from EUT and at least 80 cm from other units and other metal planes

5.2 Test Standard and Limit

FCC Part 15 Subpart C

Frequency MHz	Limits dB(μV)	
	Quasi-peak Level	Average Level
0.15~0.50	66 ~ 56*	55 ~ 46*
0.50~5.00	56	46
5.00~30.00	60	50

- Notes:
1. \*Decreasing linearly with logarithm of frequency.
  2. The lower limit shall apply at the transition frequencies.

5.3 EUT Configuration on Test

The following equipment's are installed on conducted emission test to meet FCC Part 15 Subpart C requirement and operating in a manner which tends to maximize its emission characteristics in a normal application.

5.4 Operating Condition of EUT

- 5.4.1 Setup the EUT and simulators as shown in Section 5.1.
- 5.4.2 Turn on the power of all equipments.
- 5.4.3 Let the EUT work in test modes and test it.



### 5.5 Test Procedure

The EUT is put on the table and connected to the AC mains through a Artificial Mains Network (AMN) or ISN. This provided a 50ohm coupling impedance for the tested equipments. Both sides of AC line are checked to find out the maximum conducted emission levels according to the **ANSI C63.4** regulations during conducted emission test.

The bandwidth of the test receiver (R&S Test Receiver ESR) is set at 10KHz.

The frequency range from 150 KHz to 30 MHz is investigated.

Notes:

- 1.An initial pre-scan was performed on the line and neutral lines with peak detector.
- 2.Quasi-Peak and Average measurement were performed at the frequencies with maximized peak emission.
- 3.Mesurement Level = Reading level + Correct Factor

### 5.6 Test Result

PASS

Please refer to the following page.





Conducted Emission Test Data			
Temperature:	24.5 °C	Relative Humidity:	54%
Pressure:	1009hPa	Phase:	Line
Test Voltage:	AC 120V/60Hz	Test Mode:	Mode 4

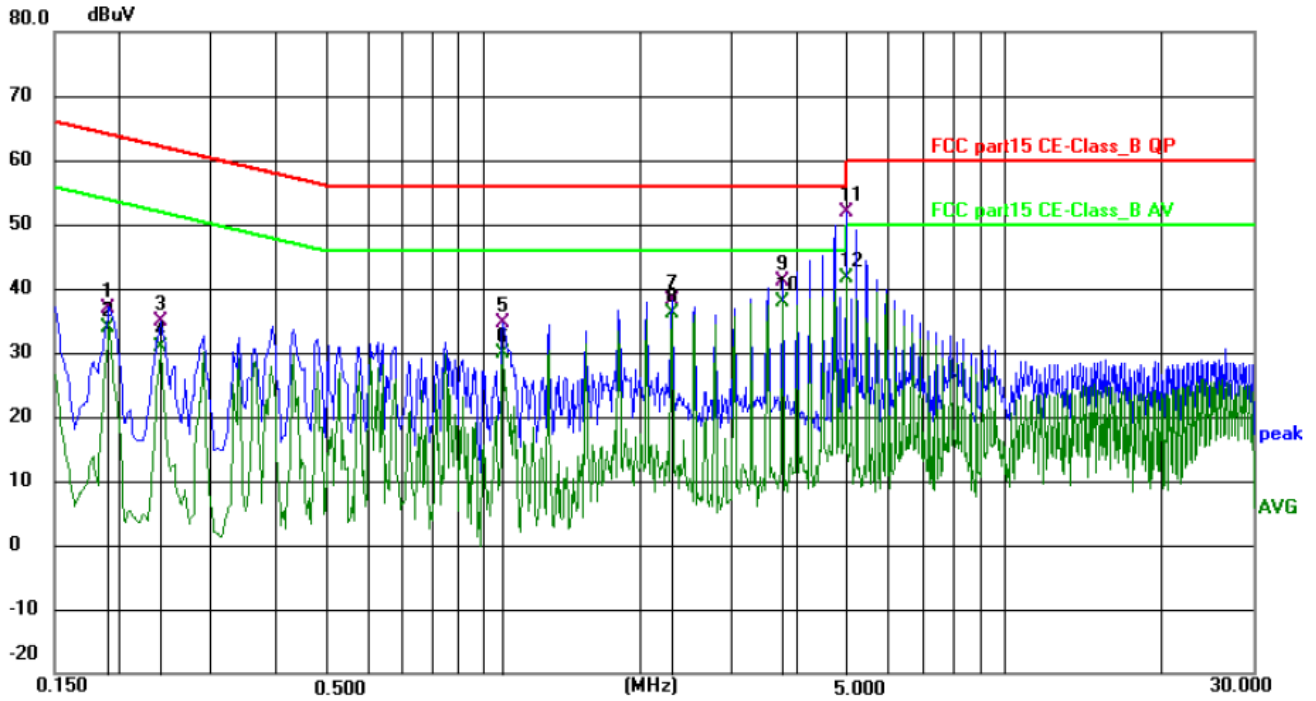

No.	Frequency (MHz)	Reading (dBuV)	Factor (dB)	Level (dBuV)	Limit (dBuV)	Margin (dB)	Detector	P/F	Remark
1	0.190100	27.33	9.67	37.00	64.03	-27.03	QP	P	
2	0.190100	24.26	9.67	33.93	54.03	-20.10	AVG	P	
3	0.240000	25.47	9.37	34.84	62.10	-27.26	QP	P	
4	0.240000	21.59	9.37	30.96	52.10	-21.14	AVG	P	
5	1.090500	25.38	9.33	34.71	56.00	-21.29	QP	P	
6	1.090500	20.57	9.33	29.90	46.00	-16.10	AVG	P	
7	2.301000	28.77	9.48	38.25	56.00	-17.75	QP	P	
8	2.301000	26.75	9.48	36.23	46.00	-9.77	AVG	P	
9	3.754500	31.77	9.36	41.13	56.00	-14.87	QP	P	
10	3.754500	28.44	9.36	37.80	46.00	-8.20	AVG	P	
11 *	4.964900	42.15	9.67	51.82	56.00	-4.18	QP	P	
12	4.964900	31.88	9.67	41.55	46.00	-4.45	AVG	P	



Conducted Emission Test Data			
Temperature:	24.5 °C	Relative Humidity:	54%
Pressure:	1009hPa	Phase:	Neutral
Test Voltage:	AC 120V/60Hz	Test Mode:	Mode 4

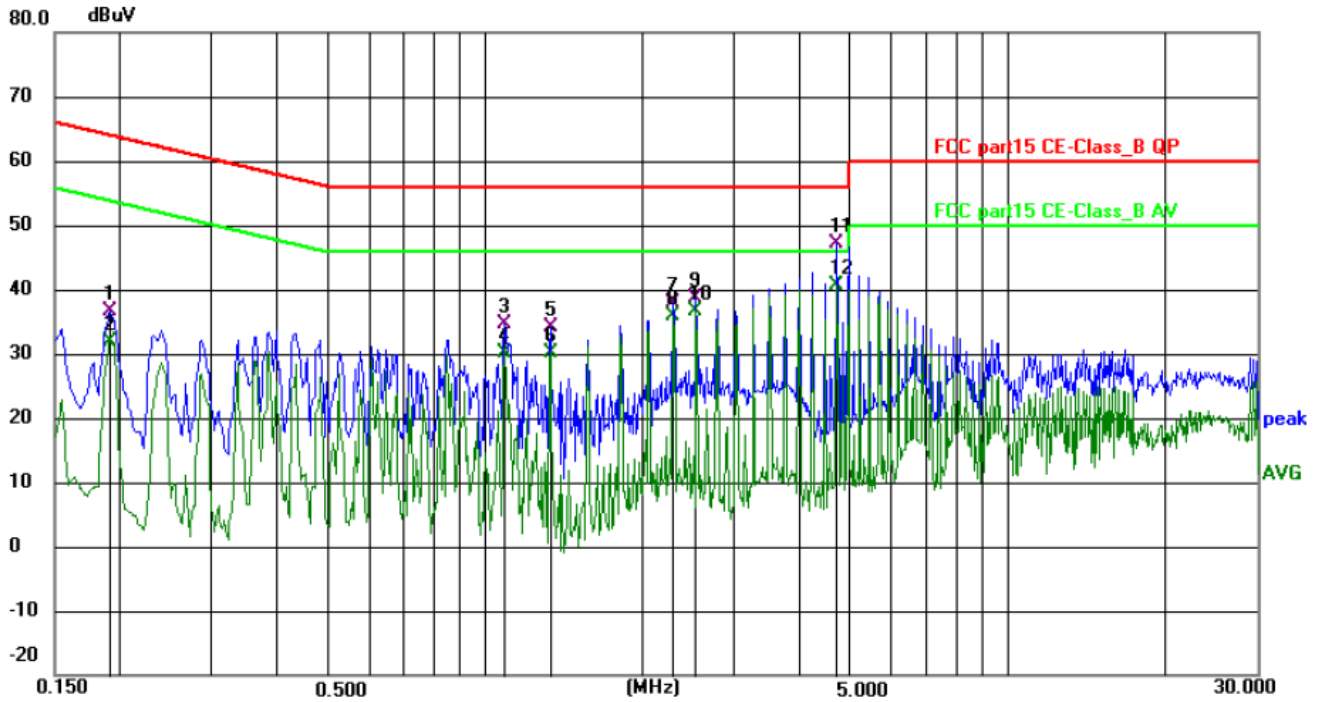

No.	Frequency (MHz)	Reading (dBuV)	Factor (dB)	Level (dBuV)	Limit (dBuV)	Margin (dB)	Detector	P/F	Remark
1	0.190500	27.45	9.13	36.58	64.01	-27.43	QP	P	
2	0.190500	22.82	9.13	31.95	54.01	-22.06	AVG	P	
3	1.090500	25.22	9.45	34.67	56.00	-21.33	QP	P	
4	1.090500	20.74	9.45	30.19	46.00	-15.81	AVG	P	
5	1.333200	24.53	9.55	34.08	56.00	-21.92	QP	P	
6	1.333200	20.70	9.55	30.25	46.00	-15.75	AVG	P	
7	2.296400	27.99	9.83	37.82	56.00	-18.18	QP	P	
8	2.296400	26.08	9.83	35.91	46.00	-10.09	AVG	P	
9	2.539300	28.83	9.83	38.66	56.00	-17.34	QP	P	
10	2.539300	26.75	9.83	36.58	46.00	-9.42	AVG	P	
11	4.717500	37.35	9.80	47.15	56.00	-8.85	QP	P	
12 *	4.717500	30.75	9.80	40.55	46.00	-5.45	AVG	P	

## 6. RADIATION EMISSION TEST

### 6.1 Block Diagram of Test Setup

Radiated Emission Test-Up Frequency Below 30MHz

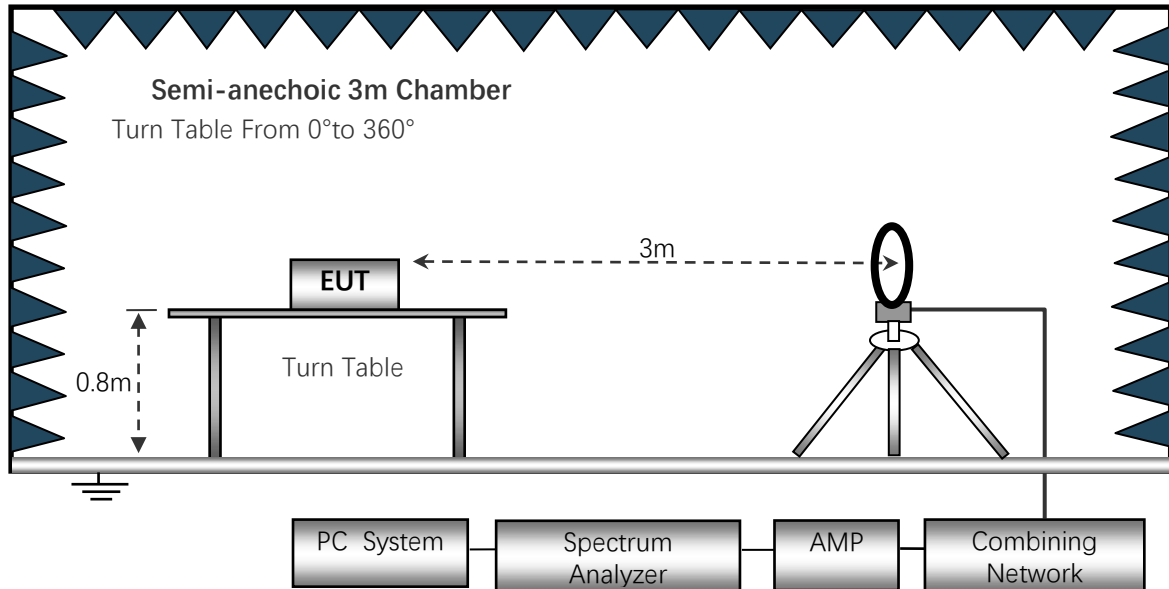

Below 1GHz

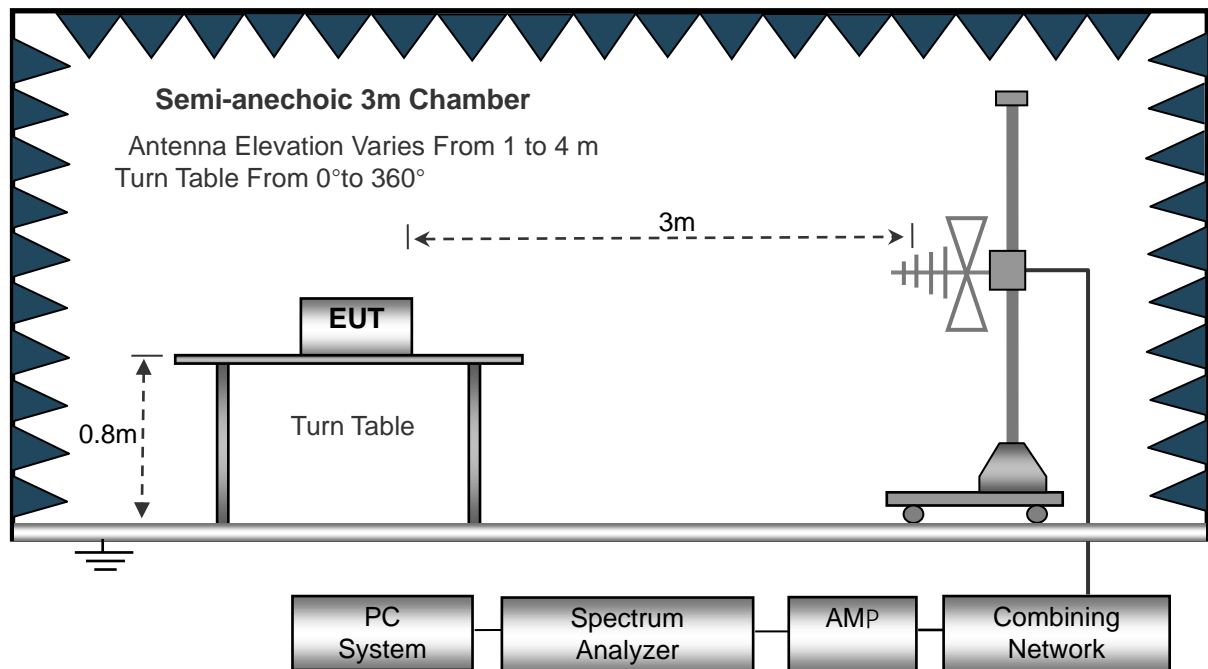

### 6.2 Test Standard and Limit

FCC Part 15 Subpart C



Limits for frequency below 30MHz

Frequency	Limit (uV/m)	Measurement Distance(m)	Remark
0.009-0.090	2400/F(kHz)	300	AVERAGE
0.090-0.110	2400/F(kHz)	300	Quasi-peak Value
0.110-0.490	2400/F(kHz)	300	AVERAGE
0.490-1.705	24000/F(kHz)	30	Quasi-peak Value
1.705-30	30	30	Quasi-peak Value

Above 30MHz

Frequency (MHz)	Distance (Meters)	Field Strengths Limits (dB $\mu$ V/m)	Remark
30 ~ 88	3	40.0	Quasi-peak Value
88 ~ 216	3	43.5	Quasi-peak Value
216 ~ 960	3	46.0	Quasi-peak Value
960 ~ 1000	3	54.0	Quasi-peak Value
Above 1000	3	74.0	PEAK
		54.0	AVERAGE

Remark:

(1) The smaller limit shall apply at the cross point between two frequency bands.

(2) Distance refers to the distance in meters between the measuring instrument, antenna and the closed point of any part of the device or system.

### 6.3 EUT Configuration on Test

The FCC Part 15 Subpart C regulations test method must be used to find the maximum emission during radiated emission test.

The configuration of EUT is the same as used in conducted emission test.

Please refer to Section 5.3.

### 6.4 Operating Condition of EUT

Same as conducted emission test, which is listed in Section 5.4 except the test set up replaced as Section 6.2.

### 6.5 Test Procedure

1) The radiated emissions test was conducted in a semi-anechoic chamber.

2) The tabletop EUT was placed upon a non-metallic table 0.8m above the ground reference plane. And for floor-standing arrangement, the EUT was placed on the horizontal ground reference plane, but separated from metallic contact with the ground reference plane by 0.1m of insulation.

3) Before final measurements of radiated emissions, a pre-scan was performed in the spectrum mode with the peak detector to find out the maximum emissions spectrum plots of the EUT.

4) The frequencies of maximum emission were determined in the final radiated emissions measurement. At each frequency, the EUT was rotated 360°, and the antenna was raised and lowered from 1 to 4 meters in order to determine the maximum disturbance. Measurements were performed for both horizontal and vertical antenna polarization.

5) The bandwidth setting on the field strength meter (R&S Test Receiver ESCI) is set at 120KHz.

6) The frequency range from 30MHz to 1000MHz is checked.

### 6.6 Test Result

PASS, Please refer to the following page.



Radiation Emission Test Data 9 kHz~30 MHz			
Temperature:	24.5 °C	Relative Humidity:	54%
Pressure:	1009hPa	Polarization:	/
Test Voltage:	AC 120V/60Hz	Test Mode:	Mode 4

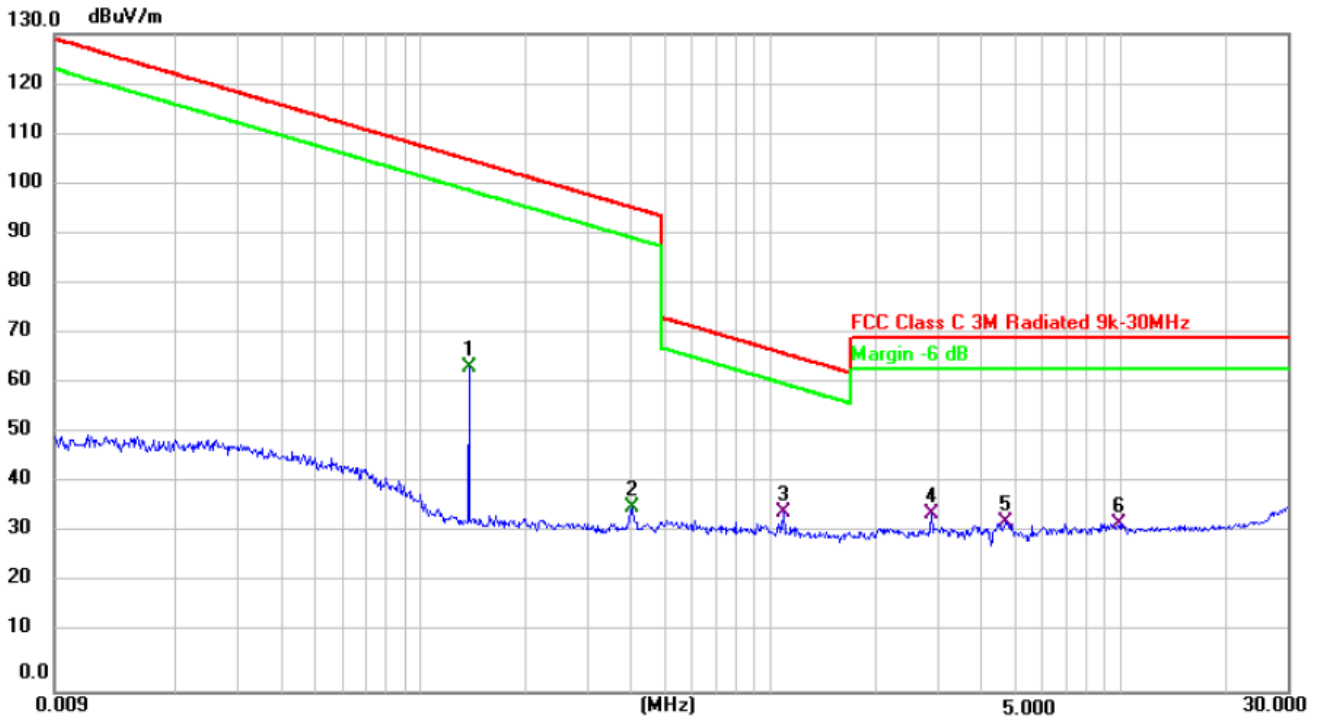

Frequency (MHz)	Meter Reading (dBμV)	Factor (dB)	Emission Level (dBμV/m)	Limits (dBμV/m)	Margin (dB)	Detector Type
0.1332	46.37	20.11	66.48	105.14	-38.66	AVERAGE
0.4053	16.78	20.22	37.00	95.69	-58.69	QP
1.0872	13.65	20.32	33.97	66.97	-33.00	QP
2.8745	19.69	20.39	40.08	70.00	-29.92	QP
4.6866	14.62	20.47	35.09	70.00	-34.91	QP
9.9541	13.58	20.58	34.16	70.00	-35.84	QP

Note:

Pre-scan in the all of mode, the worst case in of was recorded.

Factor = antenna factor + cable loss – pre-amplifier.

Margin = Emission Level(Meter Reading+ Factor) - Limit.



Radiation Emission Test Data 9 kHz~30 MHz			
Temperature:	24.5 °C	Relative Humidity:	54%
Pressure:	1009hPa	Polarization:	/
Test Voltage:	AC 120V/60Hz	Test Mode:	Mode 4

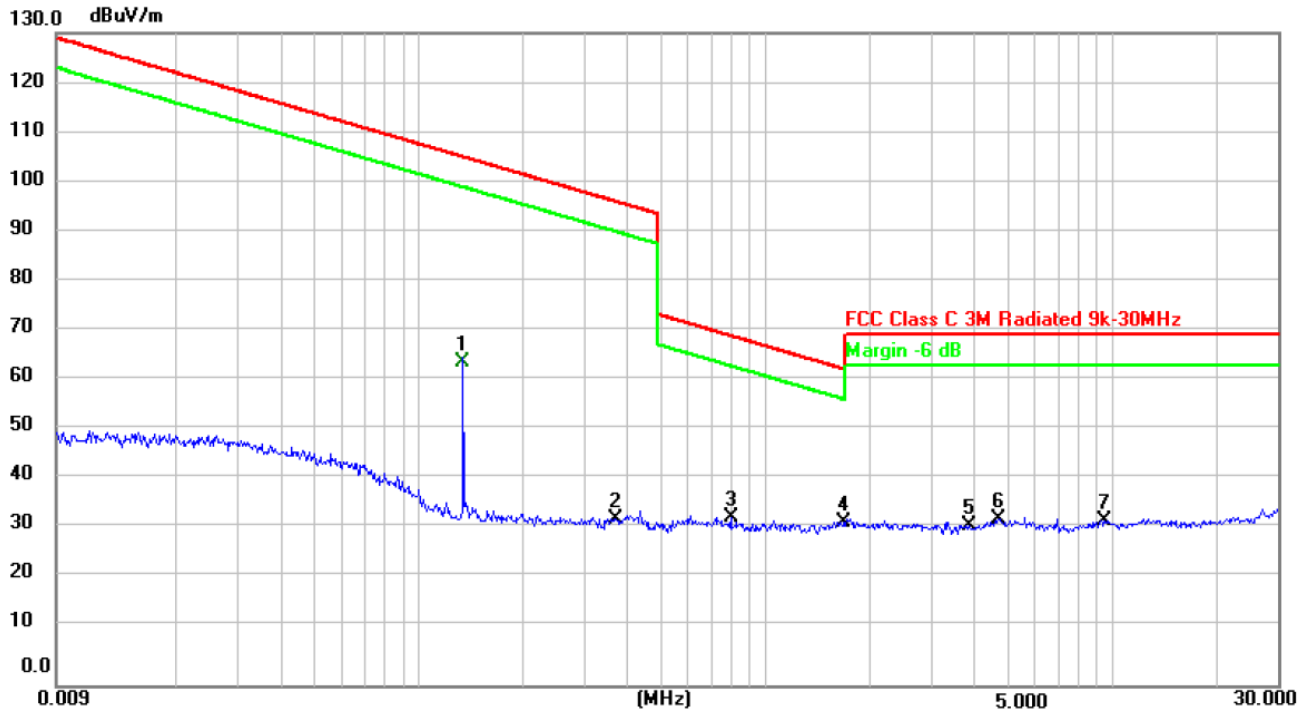

Frequency (MHz)	Meter Reading (dBμV)	Factor (dB)	Emission Level (dBμV/m)	Limits (dBμV/m)	Margin (dB)	Detector Type
0.1340	45.05	20.11	65.16	105.35	-40.19	AVERAGE
0.3694	13.52	20.21	33.73	95.47	-61.74	QP
0.7922	13.37	20.27	33.64	69.76	-36.12	QP
1.6846	11.25	20.33	31.58	63.11	-31.53	QP
3.8532	12.18	20.41	32.59	70.00	-37.41	QP
4.6814	10.07	20.47	30.54	70.00	-39.46	QP

Note:

Pre-scan in the all of mode, the worst case in of was recorded.

Factor = antenna factor + cable loss – pre-amplifier.

Margin = Emission Level(Meter Reading+ Factor) - Limit.



Radiation Emission Test Data			
Temperature:	24.5 °C	Relative Humidity:	54%
Pressure:	1009hPa	Polarization:	Horizontal
Test Voltage:	AC 120V/60Hz	Test Mode:	Mode 4

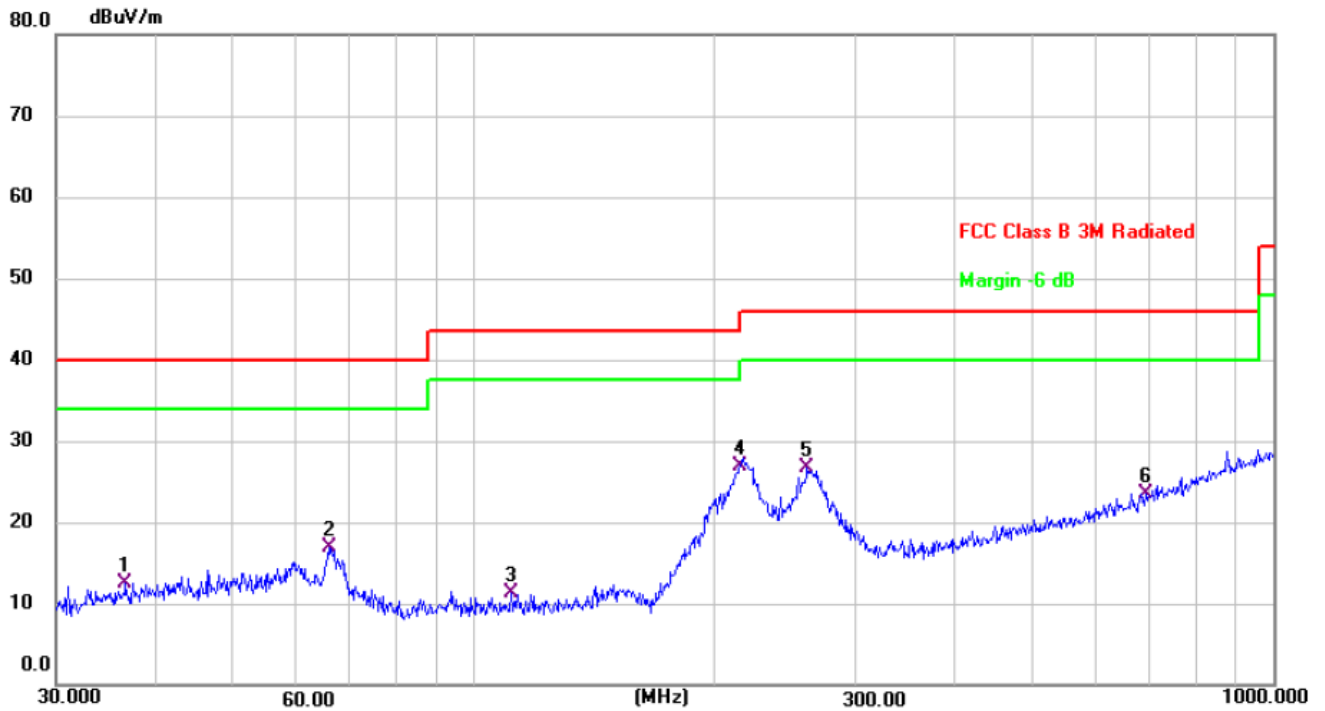

No.	Mk.	Freq. MHz	Reading Level dBuV	Correct Factor dB	Measure- ment dBuV/m	Limit dB/m	Margin dB	Detector
1		36.6375	27.15	-14.58	12.57	40.00	-27.43	QP
2		65.8031	31.22	-14.26	16.96	40.00	-23.04	QP
3		111.3468	27.87	-16.53	11.34	43.50	-32.16	QP
4	*	215.2678	41.06	-14.12	26.94	43.50	-16.56	QP
5		261.0583	39.17	-12.44	26.73	46.00	-19.27	QP
6		691.9867	27.64	-4.06	23.58	46.00	-22.42	QP



Radiation Emission Test Data			
Temperature:	24.5 °C	Relative Humidity:	54%
Pressure:	1009hPa	Polarization:	Vertical
Test Voltage:	AC 120V/60Hz	Test Mode:	Mode 4

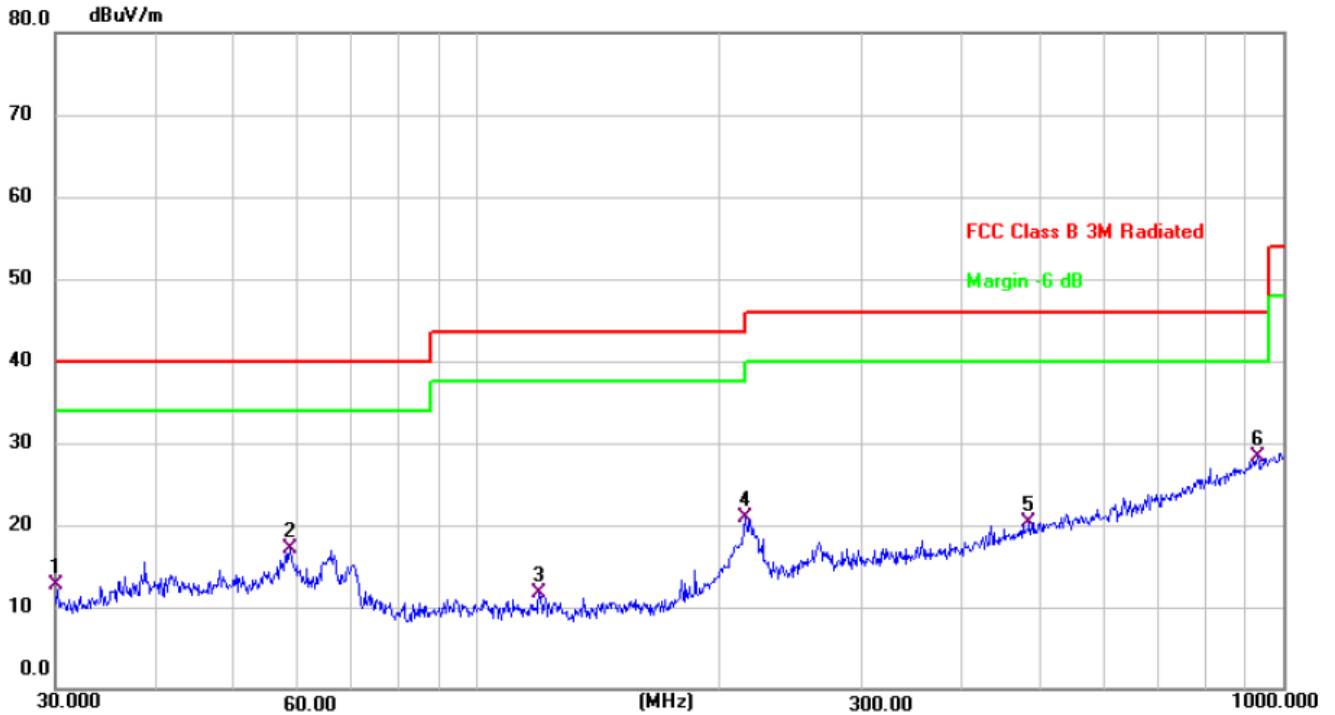

No. Mk.	Freq. MHz	Reading Level dBuV	Correct Factor dB	Measure- ment dBuV/m	Limit dB/m	Margin dB	Detector
1	30.0000	28.73	-16.05	12.68	40.00	-27.32	QP
2	58.6126	29.87	-12.77	17.10	40.00	-22.90	QP
3	119.4361	28.12	-16.50	11.62	43.50	-31.88	QP
4	215.2678	35.00	-14.12	20.88	43.50	-22.62	QP
5	483.9094	28.24	-7.90	20.34	46.00	-25.66	QP
6 *	929.0082	28.46	-0.09	28.37	46.00	-17.63	QP

Remarks:

1. Final Level = Receiver Read level + Correct factor (Antenna Factor + Cable Loss – Pre-amplifier Factor)
2. The emission levels of other frequencies are very lower than the limit and not show in test report.





**7. BANDWIDTH TEST**

**7.1 TEST SETUP**

1. Set RBW = 300Hz.
2. Set the video bandwidth (VBW)  $\geq 3 \times$  RBW.
3. Detector = Peak.
4. Trace mode = max hold.
5. Sweep = auto couple.
6. Allow the trace to stabilize.
7. Measure the maximum width of the emission that is constrained by the frequencies associated with the two outermost amplitude points (upper and lower frequencies) that are attenuated by 20 dB relative to the maximum level measured in the fundamental emission.

**7.2 TEST SETUP**



**7.3 TEST Result**

Frequency (KHz)	20dB bandwidth (KHz)	Result
138	8.15	Pass

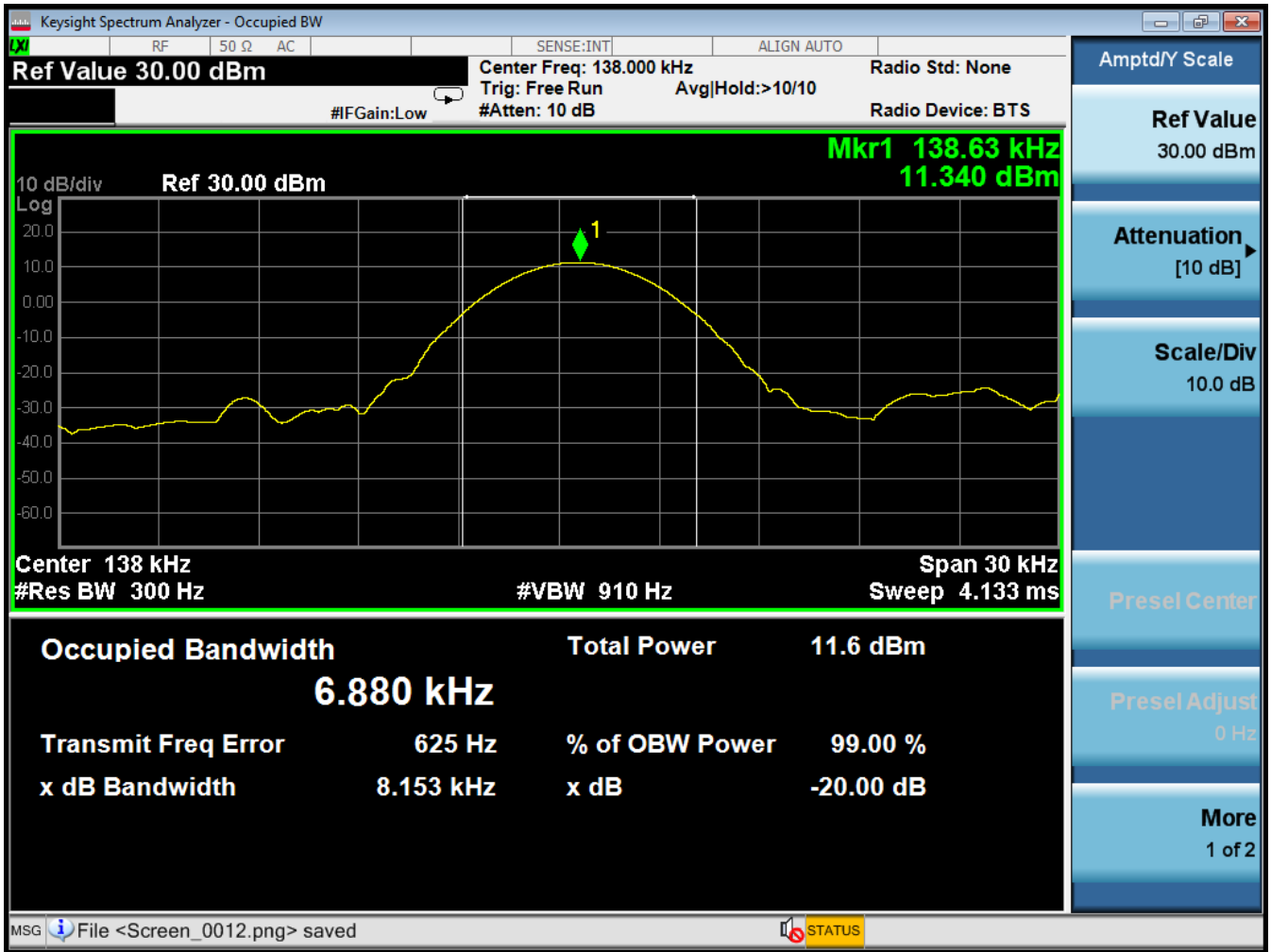



**8. SETUP PHOTOGRAPHS**

Reference to the setup photo for details.

**9. EUT PHOTOGRAPHS**

Reference to the external and internal photo for details.

**\*\*\*\*\* END OF REPORT \*\*\*\*\***