



# FCC TEST REPORT

**Test report  
On Behalf of  
Shenzhen Wittlang Electronics Co., Ltd  
For  
Energy storage power supply**

**Model No.: CN-1000W, CN-1500W, CN-2000W**

**FCC ID: 2A9OU-CN-1000W**

**Prepared For :** Shenzhen Wittlang Electronics Co., Ltd  
601, Factory Bldg#2, Jiancang Technology R & D Area, Tantou Community,  
Songgang Street, Bao'an District, Shenzhen City, Guangdong Province, China

**Prepared By :** Shenzhen HUAKE Testing Technology Co., Ltd.  
1-2/F., Building B2, Junfeng Zhongcheng Zhizao Innovation Park, Heping,  
Fuhai Street, Bao'an District, Shenzhen, Guangdong, China

**Date of Test:** Nov. 10, 2022 ~ Nov. 17, 2022

**Date of Report:** Nov. 17, 2022

**Report Number:** HK2211105039-1E



TEST RESULT CERTIFICATION

Applicant's name.....: Shenzhen Wittlang Electronics Co., Ltd
Address.....: 601, Factory Bldg#2, Jiancang Technology R & D Area, Tantou Community, Songgang Street, Bao'an District, Shenzhen City, Guangdong Province, China

Manufacture's Name .....: Shenzhen Wittlang Electronics Co., Ltd
Address.....: 601, Factory Bldg#2, Jiancang Technology R & D Area, Tantou Community, Songgang Street, Bao'an District, Shenzhen City, Guangdong Province, China

Product description

Trade Mark: N/A
Product name.....: Energy storage power supply
Model and/or type reference : CN-1000W, CN-1500W, CN-2000W

Standards.....: FCC CFR 47 PART 18

This publication may be reproduced in whole or in part for non-commercial purposes as long as the Shenzhen HUAKE Testing Technology Co., Ltd. is acknowledged as copyright owner and source of the material. Shenzhen HUAKE Testing Technology Co., Ltd. takes no responsibility for and will not assume liability for damages resulting from the reader's interpretation of the reproduced material due to its placement and context.

Date of Test .....:
Date (s) of performance of tests.....: Nov. 10, 2022 ~ Nov. 17, 2022
Date of Issue .....: Nov. 17, 2022
Test Result.....: Pass

Testing Engineer : [Signature]
(Gary Qian)

Technical Manager : [Signature]
(Eden Hu)

Authorized Signatory : [Signature]
(Jason Zhou)

The results shown in this test report refer only to the sample(s) tested unless otherwise stated and the sample(s) are retained for 30 days only. The document is issued by HUAKE, this document cannot be reproduced except in full with our prior written permission. The more details and the authenticity of the report will be confirmed at http://www.cer-mark.com.



**Table of Contents**

**Page**

1 . TEST SUMMARY	5
1.1 . Test Procedures And Results	5
1.2 . Information of the Test Laboratory	5
1.3 . Measurement Uncertainty	5
2. GENERAL INFORMATION	6
2.1. General Description of EUT	6
2.2. Carrier Frequency of Channels	7
2.3. Operation of EUT during testing	7
2.4. Description of Test Setup	7
2.5. Measurement Instruments List	8
3. CONDUCTED EMISSION TEST	9
3.1. Block Diagram of Test Setup	9
3.2. Conducted Power Line Emission Limit	9
3.3. Test Procedure	9
4. RADIATED EMISSIONS	12
4.1. Block Diagram of Test Setup	12
4.2. Rules and specifications	12
4.3. Test Procedure	13
5. ANTENNA REQUIREMENT	17
6. PHOTOGRAPH OF TEST	18
7. PHOTOS OF THE EUT	20



**\*\* Modified History \*\***

Revision	Description	Issued Data	Remark
Revision 1.0	Initial Test Report Release	Nov. 17, 2022	Jason Zhou

The results shown in this test report refer only to the sample(s) tested unless otherwise stated and the sample(s) are retained for 30 days only. The document is issued by HUAK, this document cannot be reproduced except in full with our prior written permission. The more details and the authenticity of the report will be confirmed at <http://www.cer-mark.com>.

TEL : +86-755 2302 9901 FAX : +86-755 2302 9901 E-mail : [service@cer-mark.com](mailto:service@cer-mark.com)

Address: 1-2F., Building B2, Junfeng Zhongcheng Zhizao Innovation Park, Heping Community, Fuhai Street, Bao'an District, Shenzhen, Guangdong, China



### 1. TEST SUMMARY

#### 1.1. Test Procedures And Results

DESCRIPTION OF TEST	SECTION NUMBER	RESULT
CONDUCTED EMISSIONS TEST	18.307	COMPLIANT
RADIATED EMISSION TEST	18.305	COMPLIANT

**Note:**

- 1. PASS: Test item meets the requirement.
- 2. Fail: Test item does not meet the requirement.
- 3. N/A: Test case does not apply to the test object.
- 4. The test result judgment is decided by the limit of test standard.

#### 1.2. Information of the Test Laboratory

Shenzhen HUAK Testing Technology Co., Ltd.  
 Add.: 1-2/F., Building B2, Junfeng Zhongcheng Zhizao Innovation Park, Heping,  
 Fuhai Street, Bao'an District, Shenzhen, Guangdong, China

Testing Laboratory Authorization :  
 A2LA Accreditation Code is 4781.01.  
 FCC Designation Number is CN1229.  
 Canada IC CAB identifier is CN0045.  
 CNAS Registration Number is L9589.

#### 1.3. Measurement Uncertainty

Measurement Uncertainty

Conducted Emission Expanded Uncertainty	=	2.71dB, k=2
Radiated emission expanded uncertainty(9kHz-30MHz)	=	3.90dB, k=2
Radiated emission expanded uncertainty(30MHz-1000MHz)	=	3.90dB, k=2
Radiated emission expanded uncertainty(Above 1GHz)	=	4.28dB, k=2



2. GENERAL INFORMATION

2.1. General Description of EUT

Equipment:	Energy storage power supply
Model Name:	CN-1000W
Series Models:	CN-1500W, CN-2000W
Model Difference:	All model's the function, software and electric circuit are the same, only model named and color different. Test sample mode: CN-1000W.
Trade Mark:	N/A
FCC ID:	2A9OU-CN-1000W
Antenna Type:	Coil Antenna
Antenna Gain:	0dBi
Operation frequency:	111.5KHz~205KHz
Test frequency:	136KHz
Number of Channels:	1
Modulation Type:	ASK
Power Source:	Battery Capacity: 270000Mah(999WH) DC Fixed Input: 25.5V/5A Solar Panel Input: 13V-30V Fast Charge Rated Input: 25.5V/15A DC Output: 12V/10A Max (X2) USB1 Output: 5V/3A (X1) USB2 Output: QC3 0 Wireless Charger Stand By (15W) Type-C Stand By PD65W AC(x2) Output Voltage: 110V/60Hz AC(x2) Output Power: 1000W Max Peak Value 2000W
Power Rating:	Battery Capacity: 270000Mah(999WH) DC Fixed Input: 25.5V/5A Solar Panel Input: 13V-30V Fast Charge Rated Input: 25.5V/15A DC Output: 12V/10A Max (X2) USB1 Output: 5V/3A (X1) USB2 Output: QC3 0 Wireless Charger Stand By (15W) Type-C Stand By PD65W AC(x2) Output Voltage: 110V/60Hz AC(x2) Output Power: 1000W Max Peak Value 2000W

The results shown in this test report refer only to the sample(s) tested unless otherwise stated and the sample(s) are retained for 30 days only. The document is issued by HUAK, this document cannot be reproduced except in full with our prior written permission. The more details and the authenticity of the report will be confirmed at <http://www.cer-mark.com>.



### 2.2. Carrier Frequency of Channels

Operation Frequency each of channel	
Channel	Frequency
1	136KHz

### 2.3. Operation of EUT during testing

Operating Mode

The mode is used: Transmitting mode

### 2.4. Description of Test Setup

Operation of EUT during testing:

```

graph LR
    ACPlug[AC Plug] --- Adapter[Adapter]
    Adapter --- EUT1[EUT]
    EUT1 --- Load[Load]
    EUT1 --- Resistance[Resistance]
    EUT1 --- EUT2[EUT]
  
```

Adapter information  
 Model: PSY2525000  
 Input: 100-240V~ 50/60Hz, 3.0A  
 Output: 25.2V 5.0A 126.0W

The sample was placed (0.8m (30MHz~1GHz), 0.8m (9KHz~30MHz) ) above the ground plane of 3m chamber. Measurements in both horizontal and vertical polarities were performed. During the test, each emission was maximized by: having the EUT continuously working, investigated all operating modes, rotated about all 3 axis (X, Y & Z) and considered typical configuration to obtain worst position, manipulating interconnecting cables, rotating the turntable, varying antenna height from 1m to 4m in both horizontal and vertical polarizations. The emissions worst-case are shown in Test Results of the following pages. The worst case is X position.



**2.5. Measurement Instruments List**

Item	Equipment	Manufacturer	Model No.	Serial No.	Last Cal.	Cal. Interval
1.	L.I.S.N. Artificial Mains Network	R&S	ENV216	HKE-002	Feb. 18, 2022	1 Year
2.	Receiver	R&S	ESCI 7	HKE-010	Feb. 18, 2022	1 Year
3.	RF automatic control unit	Tonscend	JS0806-2	HKE-060	Feb. 18, 2022	1 Year
4.	Spectrum analyzer	R&S	FSP40	HKE-025	Feb. 18, 2022	1 Year
5.	Spectrum analyzer	Agilent	N9020A	HKE-048	Feb. 18, 2022	1 Year
6.	Preamplifier	Schwarzbeck	BBV 9743	HKE-006	Feb. 18, 2022	1 Year
7.	EMI Test Receiver	Rohde & Schwarz	ESCI 7	HKE-010	Feb. 18, 2022	1 Year
8.	Bilog Broadband Antenna	Schwarzbeck	VULB9163	HKE-012	Feb. 18, 2022	1 Year
9.	Loop Antenna	Schwarzbeck	FMZB 1519 B	HKE-014	Feb. 18, 2022	1 Year
10.	Horn Antenna	Schwarzbeck	9120D	HKE-013	Feb. 18, 2022	1 Year
11.	Pre-amplifier	EMCI	EMC051845 SE	HKE-015	Feb. 18, 2022	1 Year
12.	Pre-amplifier	Agilent	83051A	HKE-016	Feb. 18, 2022	1 Year
13.	EMI Test Software EZ-EMC	Tonscend	JS1120-B Version	HKE-083	N/A	N/A
14.	Power Sensor	Agilent	E9300A	HKE-086	Feb. 18, 2022	1 Year
15.	Spectrum analyzer	Agilent	N9020A	HKE-048	Feb. 18, 2022	1 Year
16.	Signal generator	Agilent	N5182A	HKE-029	Feb. 18, 2022	1 Year
17.	Signal Generator	Agilent	83630A	HKE-028	Feb. 18, 2022	1 Year
18.	Shielded room	Shiel Hong	4*3*3	HKE-039	Dec. 09, 2021	3 Year

The results shown in this test report refer only to the sample(s) tested unless otherwise stated and the sample(s) are retained for 30 days only. The document is issued by HUAK, this document cannot be reproduced except in full with our prior written permission. The more details and the authenticity of the report will be confirmed at <http://www.cer-mark.com>.

TEL : +86-755 2302 9901 FAX : +86-755 2302 9901 E-mail : [service@cer-mark.com](mailto:service@cer-mark.com)

Add: 1-2F., Building B2, Junfeng Zhongcheng Zhizao Innovation Park, Heping Community, Fuhai Street, Bao'an District, Shenzhen, Guangdong, China



### 3. CONDUCTED EMISSION TEST

#### 3.1. Block Diagram of Test Setup

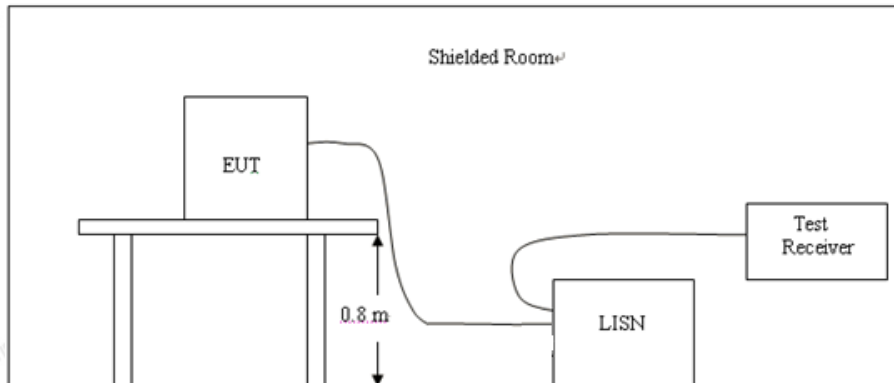

#### 3.2. Conducted Power Line Emission Limit

According to FCC Part 18.307(b)

Frequency (MHz)	Maximum RF Line Voltage (dBμV)			
	CLASS A		CLASS B	
	Q.P.	Ave.	Q.P.	Ave.
0.15 - 0.50	79	66	66-56*	56-46*
0.50 - 5.00	73	60	56	46
5.00 - 30.0	73	60	60	50

\* Decreasing linearly with the logarithm of the frequency

For intentional device, according to §18.307 Line Conducted Emission Limit is same as above table.

#### 3.3. Test Procedure

1. The equipment was set up as per the test configuration to simulate typical actual usage per the user's manual. The EUT is a tabletop system, a wooden table with a height of 0.8 meters is used and is placed on the ground plane as per ANSI C63.10.
2. Support equipment, if needed, was placed as per ANSI C63.10.
3. All I/O cables were positioned to simulate typical actual usage as per ANSI C63.10.
4. If a EUT received DC power from the USB Port of Notebook PC, the PC's adapter received AC120V/60Hz power through a Line Impedance Stabilization Network (LISN) which supplied power source and was grounded to the ground plane.
5. All support equipments received AC power from a second LISN, if any.
6. The EUT test program was started. Emissions were measured on each current carrying line of the EUT using a spectrum Analyzer / Receiver connected to the LISN powering the EUT. The LISN has two monitoring points: Line 1 (Hot Side) and Line 2 (Neutral Side). Two scans were taken: one with Line 1 connected to Analyzer / Receiver and Line 2 connected to a 50 ohm load; the second scan had Line 1 connected to a 50 ohm load and Line 2 connected to the Analyzer / Receiver.
7. Analyzer / Receiver scanned from 150 KHz to 30MHz for emissions in each of the test modes.



3.4. Test Result

PASS

All the test modes completed for test. only the worst result was reported as below:

Test Specification: Line

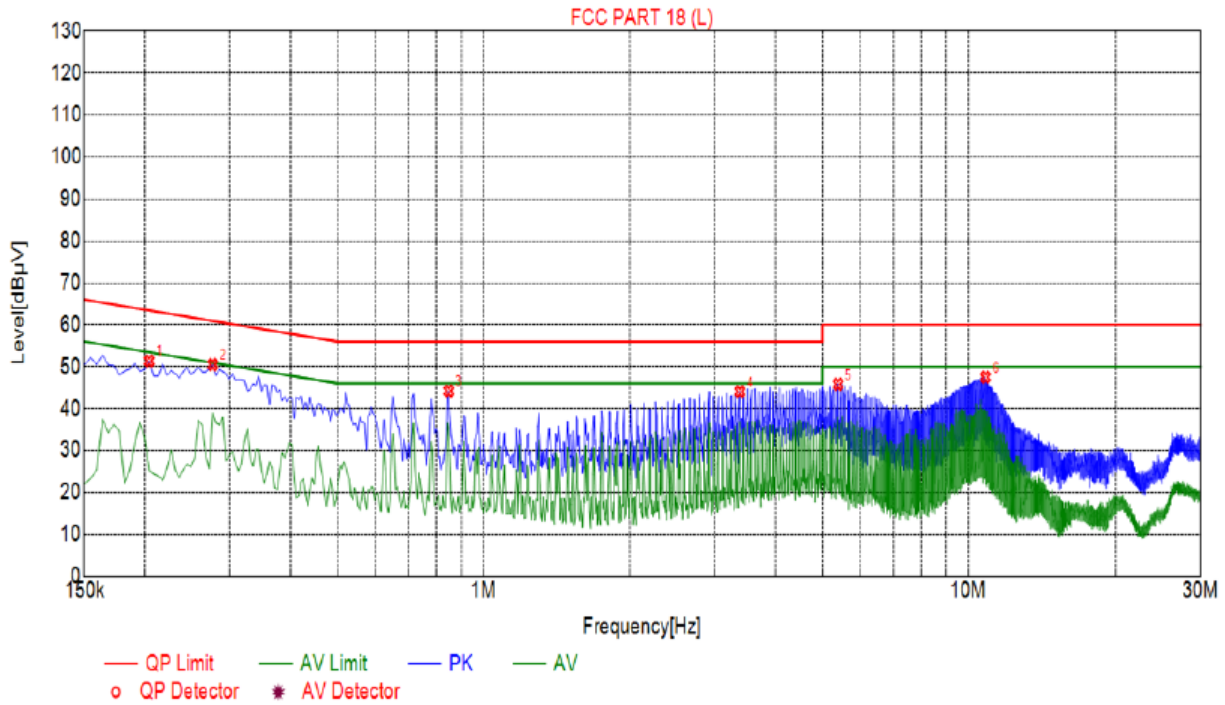

Suspected List								
NO.	Freq. [MHz]	Level [dBµV]	Factor [dB]	Limit [dBµV]	Margin [dB]	Reading [dBµV]	Detector	Type
1	0.2040	51.35	20.04	63.45	12.10	37.31	PK	L
2	0.2760	50.50	20.04	60.94	10.44	36.46	PK	L
3	0.8475	44.19	20.06	56.00	11.81	30.13	PK	L
4	3.3810	44.06	20.24	56.00	11.94	29.82	PK	L
5	5.3925	45.81	20.26	60.00	14.19	31.55	PK	L
6	10.8645	47.51	20.02	60.00	12.49	33.49	PK	L

Remark: Margin = Limit - Level

Correction factor = Cable lose + LISN insertion loss

Level=Test receiver reading + correction factor



Test Specification: Neutral

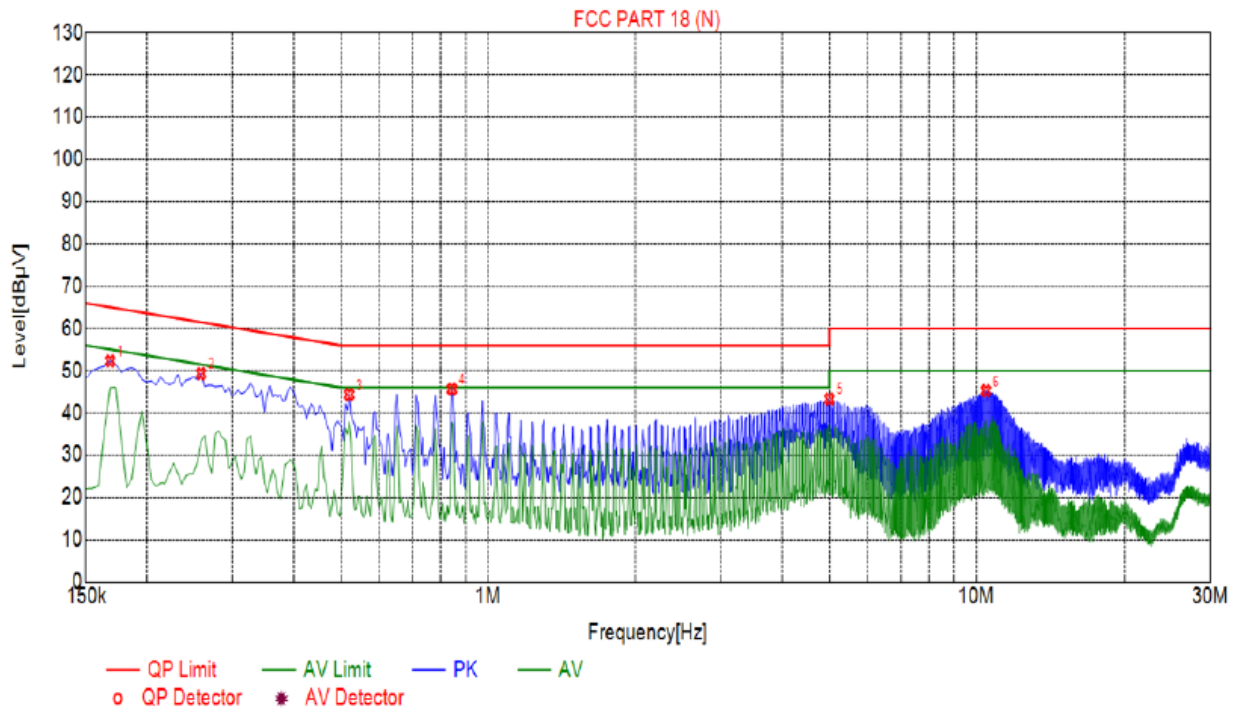

Suspected List								
NO.	Freq. [MHz]	Level [dBµV]	Factor [dB]	Limit [dBµV]	Margin [dB]	Reading [dBµV]	Detector	Type
1	0.1680	52.31	20.01	65.06	12.75	37.30	PK	N
2	0.2580	49.32	20.04	61.50	12.18	34.28	PK	N
3	0.5190	44.36	20.04	56.00	11.64	32.32	PK	N
4	0.8430	45.65	20.06	56.00	10.35	33.59	PK	N
5	5.0010	43.30	20.26	60.00	16.70	31.04	PK	N
6	10.4730	45.26	20.04	60.00	14.74	33.22	PK	N

Remark: Margin = Limit - Level

Correction factor = Cable lose + LISN insertion loss

Level=Test receiver reading + correction factor

## 4. RADIATED EMISSIONS

### 4.1. Block Diagram of Test Setup

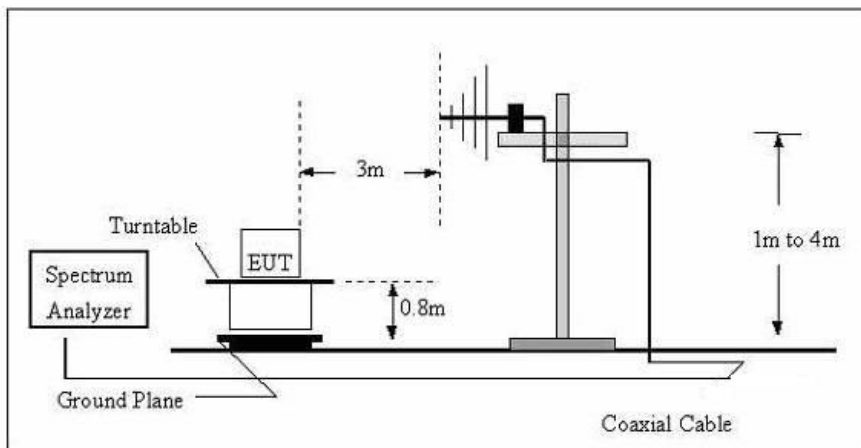
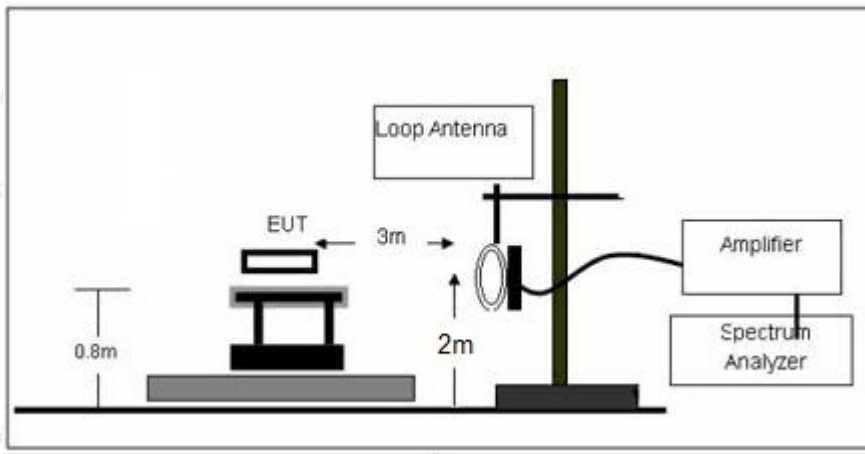

### 4.2. Rules and specifications

Except as provided elsewhere in this Subpart 18.305 (b), the field strength levels of emissions which lie outside the bands specified in §18.301, unless otherwise indicated, shall not exceed the following table:

Equipment	Operating frequency	RF Power generated by equipment (watts)	Field strength limit (uV/m)	Distance (meters)
(miscellaneous)				
	Any non-ISM frequency	Below 500 500 or more	15 15 × SQRT(power/500)	300 1300



**Remark:**

- (1) Emission level dBuV/m for 0.009~30MHz =  $20\log(15) + 40\log(300/3)$  dBuV/m;
- (2) Calculated according FCC 18.305.
- (3) The smaller limit shall apply at the cross point between two frequency bands.
- (4) Distance is the distance in meters between the measuring instrument, antenna and the closest point of any part of the device or system.

### 4.3. Test Procedure

Measurement distance 3m

For the measurement range up to 30MHz in the following plots the field strength result from 3m Distance measurements are extrapolated to 300m and 30m distance respectively, by 40dB/decade, Per antenna factor scaling.

Measurements below 1000MHz are performed with a peak detector and compared to average limits, Measurements with an average detector are not required.

**Note:**

For battery operated equipment, the equipment tests shall be performed using a new battery.

### 4.4. Test Result

**PASS**

Note: All the test modes completed for test. Only the worst result (ANT1: 15W) was reported as below:



For 9KHz - 30MHz

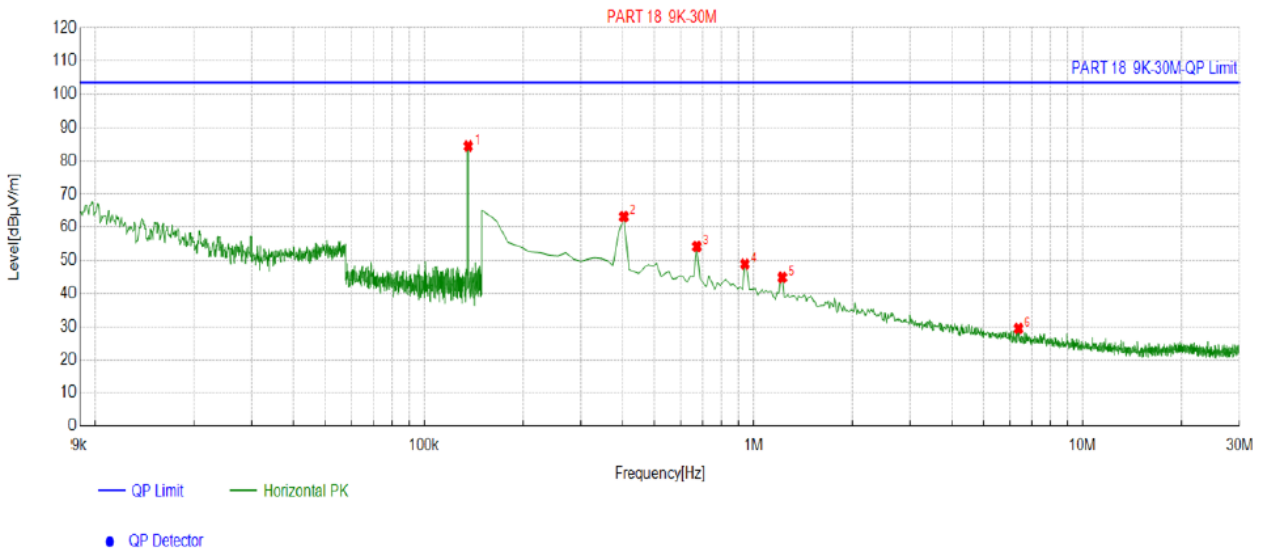

Suspected List						
NO.	Freq. [MHz]	Factor [dB]	Reading [dBµV/m]	Level [dBµV/m]	Limit [dBµV/m]	Margin [dB]
1	0.1360	13.78	70.69	84.47	103.50	19.03
2	0.4039	13.78	49.44	63.22	103.50	40.28
3	0.6726	13.78	40.40	54.18	103.50	49.32
4	0.9414	14.12	34.79	48.91	103.50	54.59
5	1.2251	14.21	30.63	44.84	103.50	58.66
6	6.3918	14.66	14.78	29.44	103.50	74.06

Remark: Factor = Cable loss + Antenna factor – Preamplifier; Level = Reading + Factor; Margin = Limit – Level



For 30MHz-1GHz

Antenna polarity: H

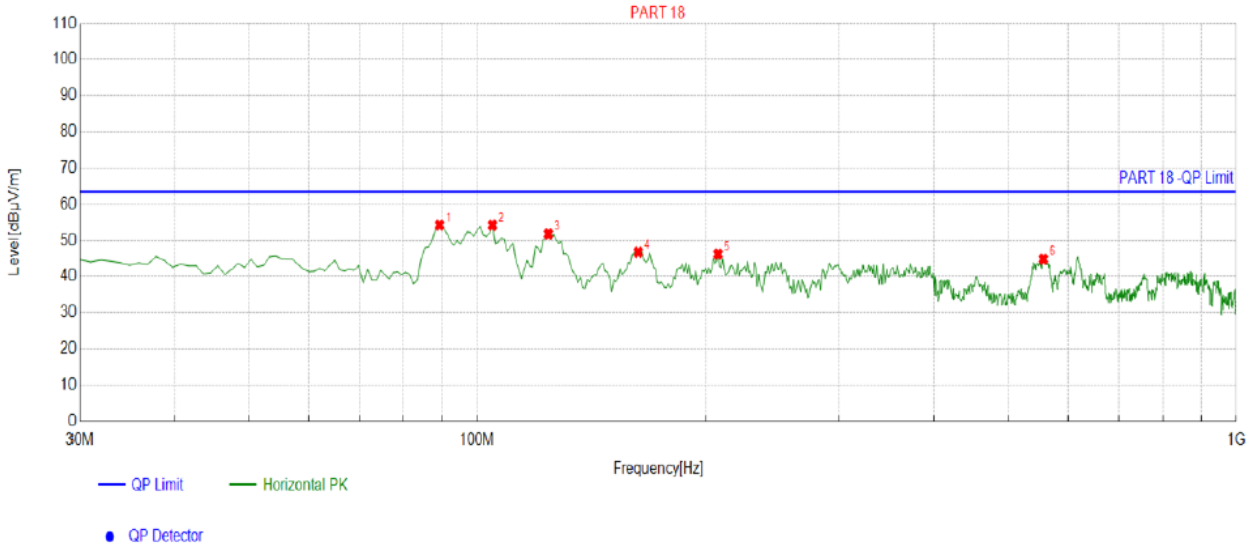

Suspected List									
NO.	Freq. [MHz]	Factor [dB]	Reading [dBµV/m]	Level [dBµV/m]	Limit [dBµV/m]	Margin [dB]	Height [cm]	Angle [°]	Polarity
1	89.2292	-17.44	71.67	54.23	63.50	9.27	100	357	Horizontal
2	104.7648	-14.83	69.02	54.19	63.50	9.31	100	357	Horizontal
3	124.1842	-16.08	67.87	51.79	63.50	11.71	100	359	Horizontal
4	163.0230	-17.19	63.95	46.76	63.50	16.74	100	352	Horizontal
5	207.6877	-14.60	60.82	46.22	63.50	17.28	100	359	Horizontal
6	557.2372	-6.02	50.86	44.84	63.50	18.66	100	358	Horizontal

Remark: Factor = Cable loss + Antenna factor – Preamplifier; Level = Reading + Factor;  
 Margin = Limit – Level



Antenna polarity: V

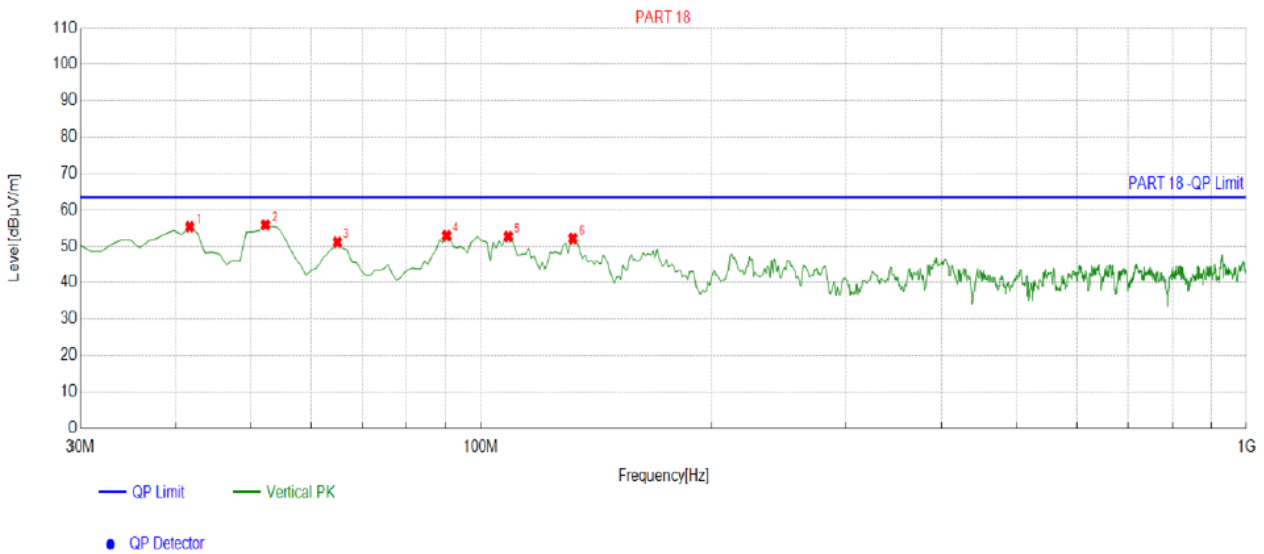

Suspected List									
NO.	Freq. [MHz]	Factor [dB]	Reading [dBµV/m]	Level [dBµV/m]	Limit [dBµV/m]	Margin [dB]	Height [cm]	Angle [°]	Polarity
1	41.6517	-15.27	70.64	55.37	63.50	8.13	100	341	Vertical
2	52.3323	-14.35	70.24	55.89	63.50	7.61	100	344	Vertical
3	64.9550	-14.59	65.71	51.12	63.50	12.38	100	336	Vertical
4	90.2002	-16.88	69.75	52.87	63.50	10.63	100	354	Vertical
5	108.6486	-14.62	67.27	52.65	63.50	10.85	100	330	Vertical
6	131.9520	-17.33	69.48	52.15	63.50	11.35	100	352	Vertical

Remark: Factor = Cable loss + Antenna factor – Preamplifier; Level = Reading + Factor;  
Margin = Limit – Level





### 5. ANTENNA REQUIREMENT

**Refer to statement below for compliance.**

The manufacturer may design the unit so that the user can replace a broken antenna, but the use of a standard antenna jack or electrical connector is prohibited. Further, this requirement does not apply to intentional radiators that must be professionally installed.

**Antenna Connected Construction**

The antenna used in this product is a Coil Antenna, which permanently attached. It conforms to the standard requirements. The directional gains of antenna used for transmitting is 0dBi.

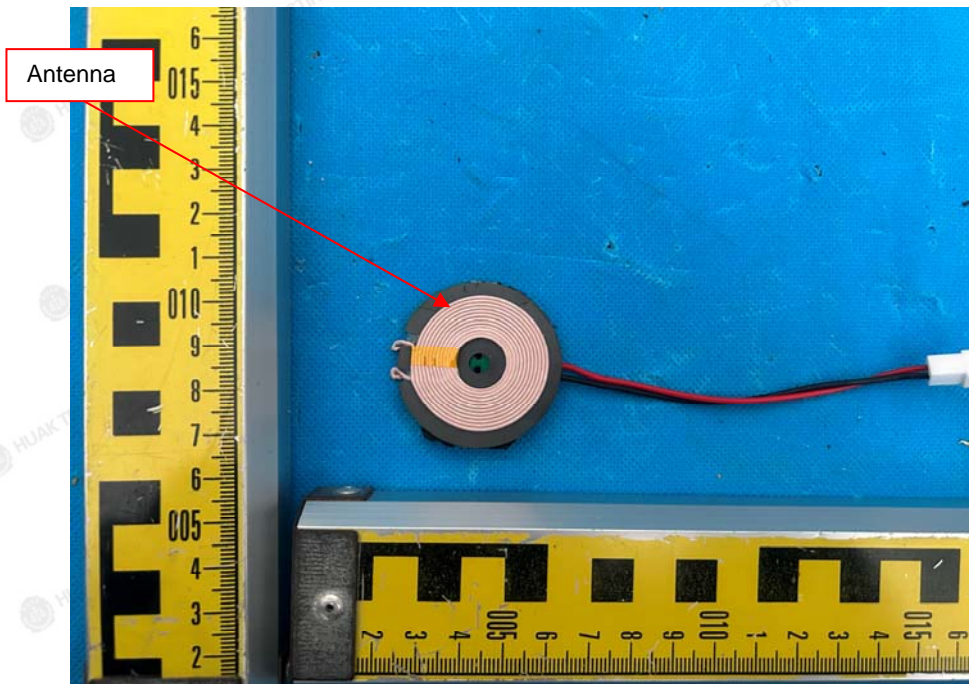



## 6. PHOTOGRAPH OF TEST

### Radiated Emission

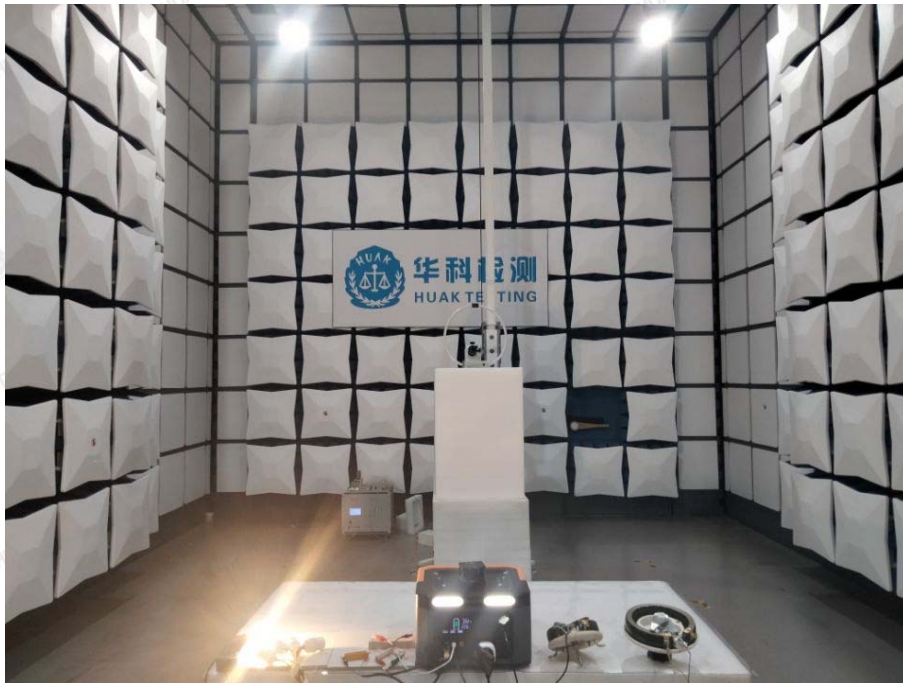
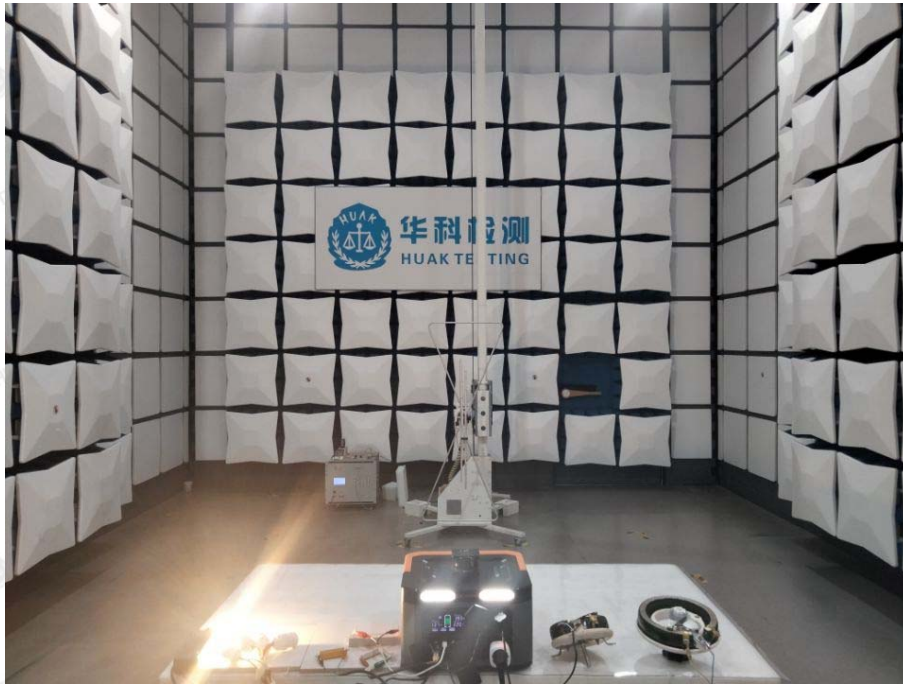

The results shown in this test report refer only to the sample(s) tested unless otherwise stated and the sample(s) are retained for 30 days only. The document is issued by HUAK, this document cannot be reproduced except in full with our prior written permission. The more details and the authenticity of the report will be confirmed at <http://www.cer-mark.com>.

TEL : +86-755 2302 9901 FAX : +86-755 2302 9901 E-mail : [service@cer-mark.com](mailto:service@cer-mark.com)

Addr: 1-2F., Building B2, Junfeng Zhongcheng Zhizao Innovation Park, Heping Community, Fuhai Street, Bao'an District, Shenzhen, Guangdong, China



**Conducted Emissions**

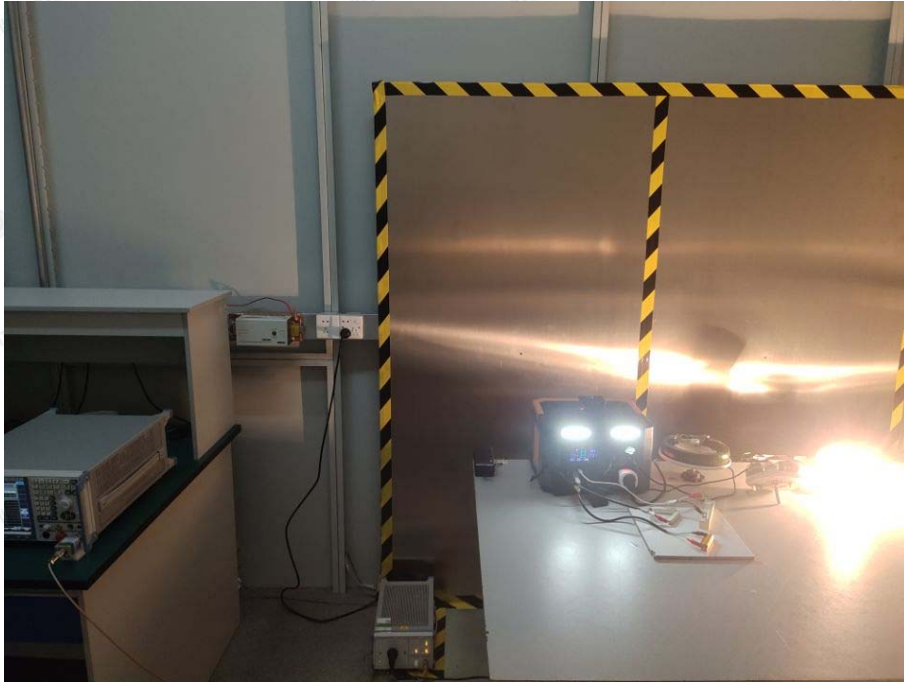

The results shown in this test report refer only to the sample(s) tested unless otherwise stated and the sample(s) are retained for 30 days only. The document is issued by HUAK, this document cannot be reproduced except in full with our prior written permission. The more details and the authenticity of the report will be confirmed at <http://www.cer-mark.com>.

TEL : +86-755 2302 9901 FAX : +86-755 2302 9901 E-mail : [service@cer-mark.com](mailto:service@cer-mark.com)

Addr: 1-2F., Building B2, Junfeng Zhongcheng Zhizao Innovation Park, Heping Community, Fuhai Street, Bao'an District, Shenzhen, Guangdong, China



## 7. PHOTOS OF THE EUT

Reference to the report: ANNEX A of external photos and ANNEX B of internal photos.

-----End of test report-----