

ULTIMEA

HDMI™

Bluetooth®



User Manual

Apollo S70

EN: User Manual

FR: Manuel de l'Utilisateur

DE: Benutzerhandbuch

IT: Manuale d'uso

JP: ユーザーマニュアル

ES: Manual del usuario

Model No.: U3700

Apollo S70 5.0 Channel Detachable Lighting Soundbar

User Manual



Model No.: U3700

WE ARE
READY
TO HELP



support@ultimea.com
support.ultimea.com

Scan code to
download app

You can also search for "ULTIMEA" on Google Play or Apple Store to download the app.



@ultimea_official

+1 888-598-8875 (US) Mon-Fri 9am-5pm (PST)
+49 89-628-25828 (EU) Mon-Fri 9am-5pm (CET)



1 ACCESSORIES LIST



Left Unit & Right Unit



Center Unit



Power Adaptor

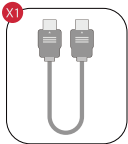

HDMI Cable

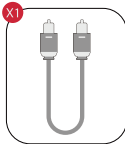

Digital Optical Cable

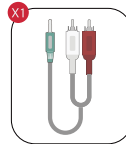

Stereo 3.5mm to RCA Audio Cable

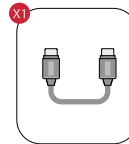

4-pin Cable for Soundbar Connection(100mm)

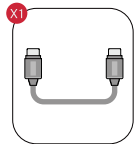

4-pin Cable for Soundbar Connection(180mm)

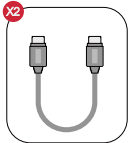

4-pin Cable for Soundbar Connection(2m)

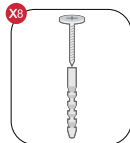

Wall Mounting Kit

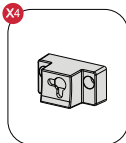

Wall Bracket



Remote Control

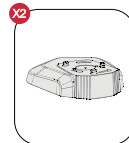

Base

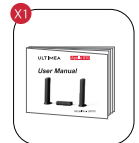

User Manual



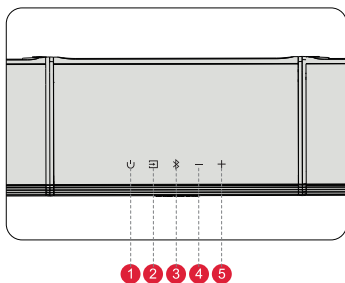























2 SOUNDBAR CONTROLS



Control Panel

- 1 "⏻": **Power Button**
Press to power on / off.
- 2 "📺": **Source**
Press to switch channels: ARC-OPT(OPTICAL)-BT-AUX-USB.
- 3 "📶": **Bluetooth**
Press to switch to BT channel and enter pairing mode. Hold for 3 seconds to disconnect current device and choose to connect to a new device manually on your mobile phone / PC / TV (BT ID: Apollo S70).
- 4 "⏮": **Volume Down**
- 5 "⏭": **Volume Up**

Remote Control

- 1 : **Power Button**
Press to power on / off.
- 2 : **SOURCE**
Press to switch channel: ARC-OPT-BT-AUX-USB
- 3 : **ARC**
Press to switch to HDMI ARC channel.
- 4 : **OPT**
Press to switch to OPTICAL channel.
- 5 : **AUX**
Press to switch to AUX channel.
- 6 : **BT**
Press to switch to BLUETOOTH channel.
- 7 : **USB**
Press to switch to USB channel.
- 8 : **INFO**
Press to view status information: Software version;
EQ; Bass/Midrange/Treble;
- 9 : **USB REPEAT**
USB mode: Press to switch between single loop playback and list loop playback.
- 10 : **Volume Up**
- 11 : **Volume Down**
- 12 : **Previous**
For BT and USB mode only: Skip to previous track.
- 13 : **Next**
For BT and USB mode only: Skip to next track.
- 14 : **Play / Pause**
For BT and USB mode only.
- 15 : **MUTE**
- 16 : **LED DIMMER**
Press to adjust display brightness in 5 levels. Press and hold for 3s to turn off the LED display.
- 17 : **BASSMAX™**
Press to adjust bass level, the display will show: "B5-6", "B5-5", "B5-4", "B5-3", "B5-2", "B5-1", "B5 0", "B5 1", "B5 2", "B5 3", "B5 4", "B5 5", "B5 6".
- 18 : **MIDRANGE**
Press to adjust alto level, the display will show: "MR-6", "MR-5", "MR-4", "MR-3", "MR-2", "MR-1", "MR 0", "MR 1", "MR 2", "MR 3", "MR 4", "MR 5", "MR 6".
- 19 : **TREBLE**
Press to adjust treble level, the display will show: "T3-6", "T3-5", "T3-4", "T3-3", "T3-2", "T3-1", "T3 0", "T3 1", "T3 2", "T3 3", "T3 4", "T3 5", "T3 6".
- 20 : **MOVIE**
Press to switch to MOVIE mode, the display will show: "MOVI".
- 21 : **MUSIC**
Press to switch to MUSIC mode, the display will show: "MUSC".
- 22 : **VOICE**
Press to switch to VOICE mode, the display will show: "VOIC".
- 23 : **SPORT**
Press to switch to SPORT mode, the display will show: "SPRT".
- 24 : **GAME**
Press to switch to GAME mode, the display will show: "GAME".
- 25 : **NIGHT**
Press to switch to NIGHT mode, the display will show: "NIGT".
- 26 : **PROMPT TONE**
Press to adjust prompt tone level, the display will show: "PT 0", "PT 1", "PT 2", "PT 3".
- 27 : **RGB LIGHTING**
Press "+" or "-" to adjust the brightness of RGB lighting effects, Short press the middle button to turn on and switch the lighting effect mode, long press for 3 seconds to turn off the lighting effect.

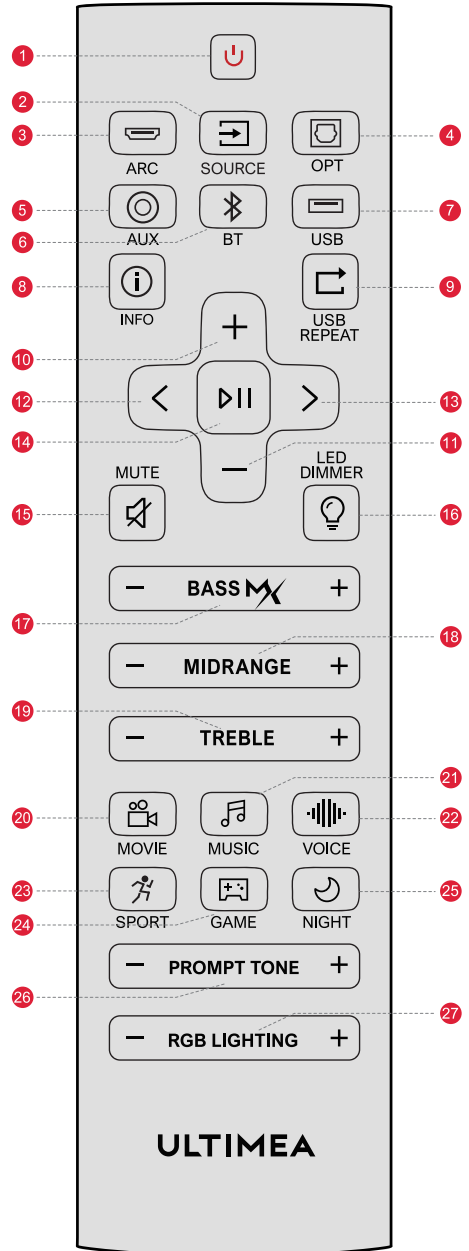

3 SOUNDBAR INSTALLATION

EN

Detached and stand on base:

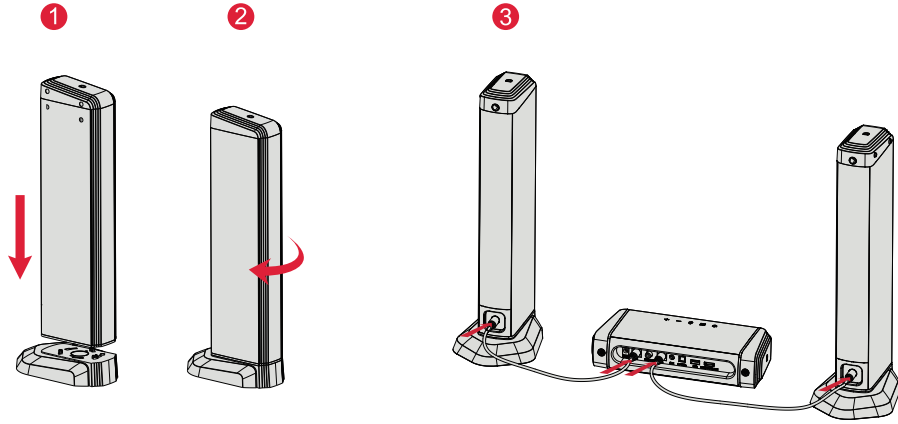

- 1 Set the soundbar on the base and align the joints.
- 2 Twist to connect with the base.
- 3 Plug in the 4-pin Cable (Cable 1 & Cable 2) for Soundbar Connection.

Note: When connecting the cable, the red terminal is plugged into the red port and the white terminal is plugged into the white port.

Horizontal placement:

- 1 Remove the covers on both sides of the host.

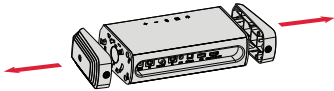

- 2 Align the joints of the three parts.



- 3 Twist to connect.



- 4 Plug in the 4-pin Cable (Cable 3 & Cable 4) for Soundbar Connection.

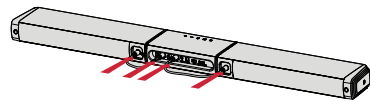

4 REAR PANEL

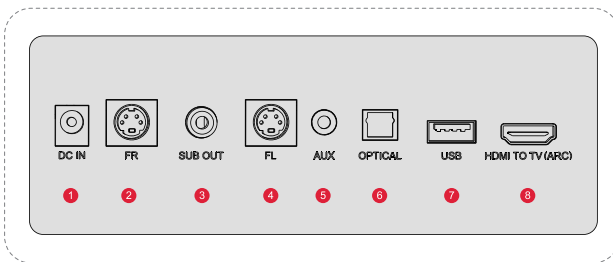

- 1 DC IN
- 2 FR: FRONT RIGHT
Used to connect the auxiliary machine on the right
- 3 SUB OUT
Connect to active subwoofer (Not Included)
- 4 FL: FRONT LEFT
Used to connect the auxiliary machine on the left
- 5 AUX
- 6 OPTICAL
- 7 USB
Support MP3 file with 128G max memory
- 8 HDMI TO TV (ARC)



5 CONNECT TO TV VIA HDMI OUT ARC

EN

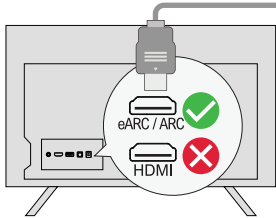

Step 1:

Connect one end of the HDMI cable to the eARC / ARC port on the back of your TV.

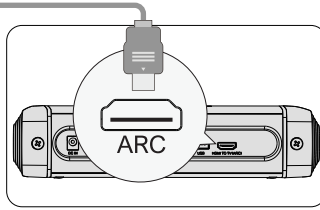

Step 2:

Then connect the other end into the ARC port of the soundbar.

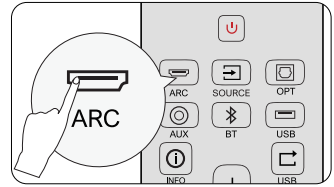

Step 3:

Press "ARC" button on the remote control to select "ARC" input.

If there is no sound, try setting the TV audio output to PCM:

TV Settings > Home > Settings > Sound > Digital Audio Output > PCM

Note: Please turn on the "CEC" function on your TV.

When eARC / ARC is connected, your TV remote control can control the soundbar and TV simultaneously:

- ❶ Turn on / off
- ❷ Adjust the volume

6 CONNECT TO TV VIA OPTICAL / AUX

OPTICAL

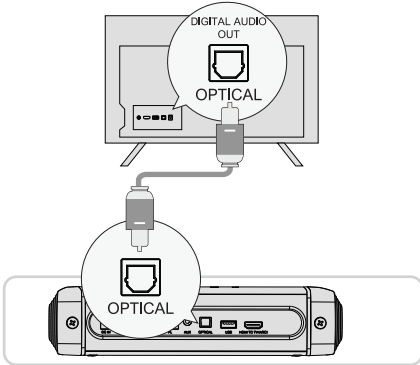

OPTION 1: OPTICAL

- ❶ Make sure the TV's port is OPTICAL OUT, connect both sides of the cable to OPTICAL, for both the TV and the soundbar.
- ❷ Make sure the optical plug is inserted correctly as it shows in the picture. Do not insert the plug upside down and break the optical.

Note: If audio is coming from the internal TV speakers, mute or minimize the TV volume.

AUX

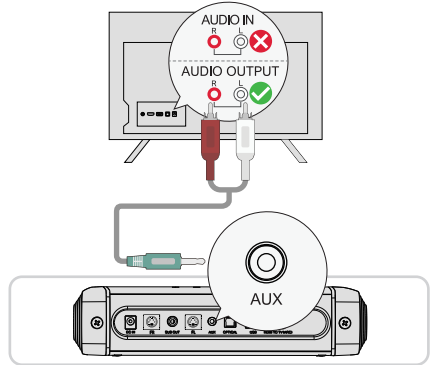

OPTION 2: AUX

- ❶ Connect the 3.5mm RCA audio cable to connect to your TV's RCA AUDIO OUT port.
- ❷ Make sure the color of the cables ends matches the color of the TV ports.

Note: Please remember to unplug the AUX cable from TV and Soundbar when you want to switch other mode.

In Optical Mode: If there is no sound, try setting the TV audio output to PCM: TV Settings > Home > Settings > Sound > Digital Audio Output > PCM

7 CONNECT TO BLUETOOTH®

- ❶ Press the "Bluetooth" button on the soundbar or press the "Bluetooth" button on the remote control to enter Bluetooth pairing mode.
- ❷ Go to the Bluetooth setting on your phone, find and select "Apollo S70" to connect the soundbar.

Note: If it's already in the Bluetooth mode and connected, press and hold "Bluetooth" button for 3 seconds to disconnect current device and choose to connect to a new device manually on your mobile phone / PC / TV.

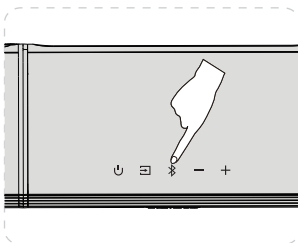

or

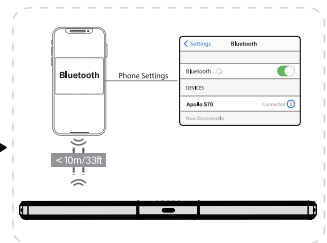
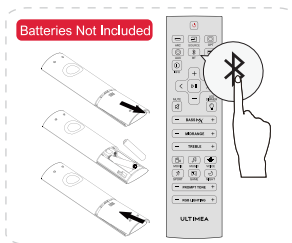

Detached and stand on base

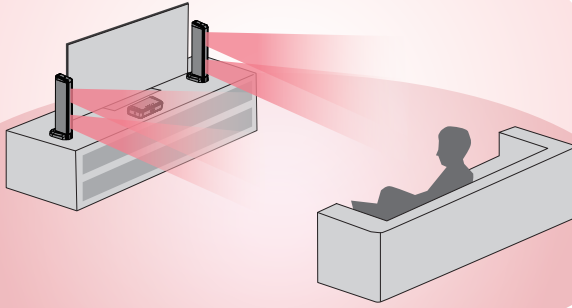

Horizontal placement

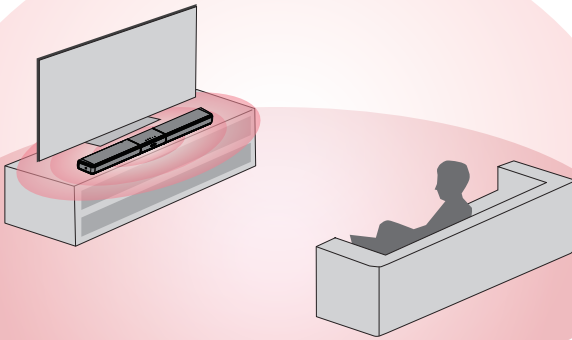

Note: The soundbar should be placed at or near ear level.

9 WALL MOUNT INSTALLATION

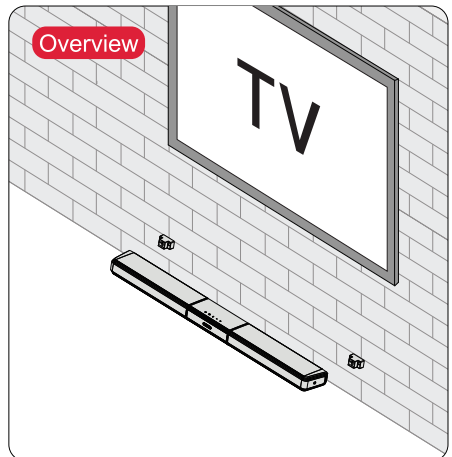
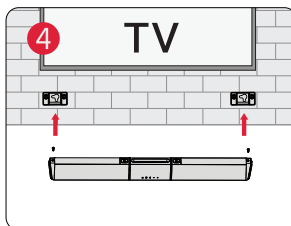
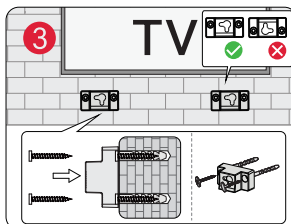
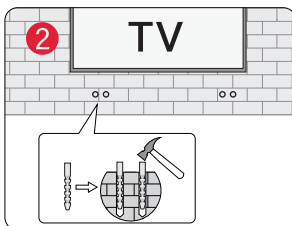
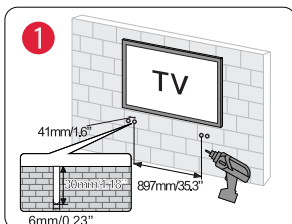

Model Number	U3700
Power Supply	AC 100 - 240V, ~50/60Hz
Soundbar Drivers	2.25"x 5 (Soundbar)
Frequency Response	55Hz - 18kHz
Standby Power	<0.5W
Operating Temperature	0°C - 45°C / 32°F - 113°F
Bluetooth Vision	5.3

Dimensions and Weight	
Soundbar	977 (W) × 110 (D) × 58 (H) 38.5" × 4.3" × 2.3"
Packaging	440 (W) × 195 (D) × 290 (H) 17.3" × 7.7" × 11.4"
Net Weight	3.0kg / 6.61lb
Gross Weight	4.2kg / 9.26lb

SAFETY INSTRUCTIONS

Please read this user manual carefully and save it for future reference.

Do not make unauthorized alterations to the product, doing so may compromise safety, regulatory compliance, system performance, and may void the warranty.

- Avoid dropping.
- Do not disassemble.
- Do not submerge in water
- Avoid extreme temperatures.
- Do not use the device outdoors during thunderstorms.
- Use original or certified cables.
- Do not place dangerous items on top of this device (e.g. liquid filled objects, lit candles).
- Clean with a dry, soft lint-free cloth. Do not use any corrosive cleaner or oil.
- To avoid hearing damage, do not listen for extended periods at high volume.
- Do not expose the batteries to extreme heat sources such as direct sunlight or open flames.
- The ideal operating temperature for this product and its accessories is between 41°F/5°C and 95°F/35°C.
- The adapter should be installed near the device and should be easily accessible.
- Do not use this product in environments of extreme heat or cold. Never expose this device to strong sunshine or wet environments.

PROPER DISPOSAL INSTRUCTIONS



This mark shown on the product or its packaging, indicates that this product should not be disposed of with other household waste at the end of its working life.

To prevent possible harm to the environment or human health from uncontrolled waste disposal, please separate this from other types of wastes and recycle it responsibly to promote the sustainable reuse of material resources.

Waste Electrical & Electronic Equipment

Household user should contact either the retailer where they purchased this product, or their local government office, for details of where and how they can take this item for environmentally safe recycling.

Business users should contact their suppliers and check the terms and conditions of the purchase contract. This product should not be mixed with other commercial wastes for disposal.

FCC REGULATORY COMPLIANCE

Any changes or modifications not expressly approved by the party responsible for compliance could void the user's authority to operate the equipment.

This device complies with Part 15 of the FCC Rules.

Operation is subject to the following two conditions:

- (1) This device may not cause harmful interference.
- (2) This device must accept any interference received, including interference that may cause undesired operation.

NOTE: This equipment has been tested and found to comply with the limits for a Class B digital device, pursuant to part 15 of the FCC Rules. These limits are designed to provide reasonable protection against harmful interference in a residential installation. This equipment generates, uses, and can radiate radio frequency energy, and if not installed and used in accordance with the instructions, may cause harmful interference to radio communications.

However, there is no guarantee that interference will not occur in a particular installation. If this equipment does cause harmful interference to radio or television reception, which can be determined by turning the equipment off and on, the user is encouraged to try to correct the interference by one or more of the following measures:

- Reorient or relocate the receiving antenna.
- Increase the separation between the equipment and the receiver.
- Connect the equipment to an outlet on a circuit different from that to which the receiver is connected.
- Consult the dealer or an experienced radio / TV technician for help.

This equipment complies with FCC radiation exposure limits set forth for an uncontrolled environment. This equipment should be installed and operated with a minimum distance of 20cm between the radiator & your body. This transmitter must not be co-located or operating in conjunction with any other antenna or transmitter.

CE WARNINGS

- 1) Do not install this equipment in a confined or building-in space such as a book case or similar unit, and remain a well ventilation conditions. The ventilation should not be impeded by covering the ventilation openings with items such as newspaper, table-cloths, curtains etc.
- 2) WARNING: To reduce the risk of fire or electric shock, do not expose this apparatus to rain or moisture. The apparatus shall not be exposed to dripping or splashing and that objects filled with liquids, such as vases, shall not be placed on apparatus.
- 3) WARNING: The adapter plug is used as disconnect device, the disconnect device shall remain readily operable.
- 5) Frequency: 2.402GHz-2.48GHz
- 6) The Max. transmit power: 10 dBm

ISED WARNINGS

This device contains licence-exempt transmitter (s) / receiver (s) that comply with Innovation, Science and Economic Development Canada's licence-exempt RSS (s). Operation is subject to the following two conditions:

- (1) This device may not cause interference.
- (2) This device must accept any interference, including interference that may cause undesired operation of the device.

L'émetteur/récepteur exempt de licence contenu dans le présent appareil est conforme aux CNR d'Innovation, Sciences et Développement économique Canada applicables aux appareils radio exempts de licence. L'exploitation est autorisée aux deux conditions suivantes:

- (1) L'appareil ne doit pas produire de brouillage;
- (2) L'appareil doit accepter tout brouillage radioélectrique subi, même si le brouillage est susceptible d'en compromettre le fonctionnement.

The device meets the exemption from the routine evaluation limits in section 2.5 of RSS 102 and compliance with RSS-102 RF exposure, users can obtain Canadian information on RF exposure and compliance.

Le dispositif rencontre l'exemption des limites courantes d'évaluation dans la section 2.5 de RSS 102 et la conformité à l'exposition de RSS-102 rf, utilisateurs peut obtenir l'information canadienne sur l'exposition et la conformité de rf.

This transmitter must not be co-located or operating in conjunction with any other antenna or transmitter. This equipment should be installed and operated with a minimum distance of 20 centimeters between the radiator and your body.

Cet émetteur ne doit pas être Co-placé ou ne fonctionnant en même temps qu'aucune autre antenne ou émetteur. Cet équipement devrait être installé et actionné avec une distance minimum de 20 centimètres entre le radiateur et votre corps.

Declaration of Conformity

We (Manufacturer is responsible for this declaration)
Ultimea Technology (Shenzhen) Limited
(Company name)

20th Floor, Building 4, Tianan Cloud Park, Bantian St.,
Longgang District Shenzhen, China 518000
(Company address)

Declare under our sole responsibility that the product
Trade Mark: ULTIMEA
Product Name: Apollo S70 5.0 Channel Detachable
Lighting Soundbar
Model No.: U3700

To which this declaration relates is in conformity with
the essential requirement set out in the Council Directive
on the Approximation of the laws of the Member States
relating to RED Directive (2014/53/EU) & RoHS (2011/
65/EU) product is responsible to affix CE marking, the
following standards were applied:

EN 55032:2015/A1:2020
EN 55035:2017/A11:2020
EN IEC 61000-3-2:2019/A1:2021
EN 61000-3-3:2013/A2:2021
ETSI EN 301 489-1 V2.2.3 (2019-11)
ETSI EN 301 489-17 V3.2.4 (2020-09)
ETSI EN 300 328 V2.2.2 (2019-07)
EN 50663: 2017
EN IEC 62368-1:2020+A11:2020
IEC 62321-3-1:2013
IEC 62321-4:2013+A1:2017
IEC 62321-5:2013
IEC 62321-6:2015
IEC 62321-7-1:2015
IEC 62321-7-2:2017
IEC 62321-8:2017

Full Name: Yoyo.Yu

Position: Approbation Manager

Signature: 

Place/Date: Shenzhen, China / June. 30-2024

Trade Marks:



The Bluetooth® word mark and logos are registered trademarks owned by Bluetooth SIG, Inc. and any use of such marks by Soundlab Technology Co.,Ltd. is under license. Other trademarks and trade names are those of their respective owners.



The terms HDMI, HDMI High-Definition Multimedia Interface, HDMI trade dress and the HDMI Logos are trademarks or registered trademarks of HDMI Licensing Administrator, Inc.

ULTIMEA

Apollo S70 5.0 Channel Detachable Lighting Soundbar
Model No.: U3700

EC	REP	Ultimea GmbH Buchenring 57, 22359 Hamburg, Germany
----	-----	---

UK	REP	EVATOST CONSULTING LTD Office 101 32 Threadneedle Street, London, United Kingdom, EC2R 8AY
----	-----	--

@Dynamec Inc. All rights reserved, registered in the United States and other countries.
9804 Crescent Center Drive, Suite 604, Rancho Cucamonga, CA 91730

Made in China



Manufacturer: Ultimea Technology (Shenzhen) Limited
Address: 20th Floor, Building 4, Tianan Cloud Park,
Bantian St., Longgang District, Shenzhen, China 518000

If you need our support, kindly reach out to our service team. We are always glad to help.

+1 888-598-8875 (US)
Mon-Fri 9am-5pm (PST)
+49 89-628-25828 (EU)
Mon-Fri 9am-5pm (CET)

✉ support@ultimea.com

🌐 support.ultimea.com



@ultimea_official