



Shenzhen Huaxia Testing Technology Co., Ltd.

1F., Block A of Tongsheng Technology Building, Huahui Road, Dalang Street, Longhua District, Shenzhen, China

Telephone: +86-755-26648640
Fax: +86-755-26648637
Website: www.cqa-cert.com

Report Template Version: V05
Report Template Revision Date: 2021-11-03

Test Report

Report No.: CQASZ20240801785E-01
Applicant: Ultimea Technology (Shenzhen) Limited
Address of Applicant: 20th Floor, Building 4, Tianan Cloud Park, Bantian St., Longgang District, Shenzhen, China

Equipment Under Test (EUT):
Product: Surround Speaker
Model No.: U2621, U2523, U2521
Test Model No.: U2621
Brand Name: ULTIMEA
FCC ID: 2A900-U2621D
Standards: 47 CFR Part 15, Subpart C
KDB558074 D01 15.247 Meas Guidance v05r02
ANSI C63.10:2013

Date of Receipt: 2024-08-22
Date of Test: 2024-08-22 to 2024-09-05
Date of Issue: 2024-09-14
Test Result: **PASS***

*In the configuration tested, the EUT complied with the standards specified above.

Tested By: *Lewis Zhou*
(Lewis Zhou)

Reviewed By: *Timo Lei*
(Timo Lei)

Approved By: *Alex*
(Alex Wang)



1 Version

Revision History Of Report

Report No.	Version	Description	Issue Date
CQASZ20240801785E-01	Rev.01	Initial report	2024-09-14

2 Test Summary

Test Item	Test Requirement	Test method	Result
Antenna Requirement	47 CFR Part 15, Subpart C Section 15.203/15.247 (c)	ANSI C63.10 2013	PASS
AC Power Line Conducted Emission	47 CFR Part 15, Subpart C Section 15.207	ANSI C63.10 2013	PASS
Conducted Peak Output Power	47 CFR Part 15, Subpart C Section 15.247 (b)(3)	ANSI C63.10 2013	PASS
6dB Occupied Bandwidth	47 CFR Part 15, Subpart C Section 15.247 (a)(2)	ANSI C63.10 2013	PASS
Power Spectral Density	47 CFR Part 15, Subpart C Section 15.247 (e)	ANSI C63.10 2013	PASS
Band-edge for RF Conducted Emissions	47 CFR Part 15, Subpart C Section 15.247(d)	ANSI C63.10 2013	PASS
RF Conducted Spurious Emissions	47 CFR Part 15, Subpart C Section 15.247(d)	ANSI C63.10 2013	PASS
Radiated Spurious Emissions	47 CFR Part 15, Subpart C Section 15.205/15.209	ANSI C63.10 2013	PASS
Restricted bands around fundamental frequency (Radiated Emission)	47 CFR Part 15, Subpart C Section 15.205/15.209	ANSI C63.10 2013	PASS

3 Contents

	Page
1 VERSION	2
2 TEST SUMMARY	3
3 CONTENTS	4
4 GENERAL INFORMATION	5
4.1 CLIENT INFORMATION	5
4.2 GENERAL DESCRIPTION OF EUT	5
4.3 ADDITIONAL INSTRUCTIONS	7
4.4 TEST ENVIRONMENT	8
4.5 DESCRIPTION OF SUPPORT UNITS	8
4.6 STATEMENT OF THE MEASUREMENT UNCERTAINTY	9
4.7 TEST LOCATION	10
4.8 TEST FACILITY	10
4.9 DEVIATION FROM STANDARDS	10
4.10 OTHER INFORMATION REQUESTED BY THE CUSTOMER	10
4.11 EQUIPMENT LIST	11
5 TEST RESULTS AND MEASUREMENT DATA	12
5.1 ANTENNA REQUIREMENT	12
5.2 CONDUCTED EMISSIONS	13
5.3 CONDUCTED PEAK OUTPUT POWER	17
5.4 6dB OCCUPY BANDWIDTH	21
5.5 POWER SPECTRAL DENSITY	25
5.6 BAND-EDGE FOR RF CONDUCTED EMISSIONS	29
5.7 SPURIOUS RF CONDUCTED EMISSIONS	32
5.8 RADIATED SPURIOUS EMISSION & RESTRICTED BANDS	41
5.8.1 <i>Spurious Emissions</i>	41
6 PHOTOGRAPHS - EUT TEST SETUP	48
6.1 RADIATED EMISSION	48
6.2 CONDUCTED EMISSION	49
7 PHOTOGRAPHS - EUT CONSTRUCTIONAL DETAILS	50

4 General Information

4.1 Client Information

Applicant:	Ultimea Technology (Shenzhen) Limited
Address of Applicant:	20th Floor, Building 4, Tianan Cloud Park, Bantian St., Longgang District, Shenzhen, China
Manufacturer:	Ultimea Technology (Shenzhen) Limited
Address of Manufacturer:	20th Floor, Building 4, Tianan Cloud Park, Bantian St., Longgang District, Shenzhen, China
Factory:	Zhong Shan City Richsound Electronic Industrial Ltd.
Address of Factory:	No.16, East Shagang Road, Gangkou, Zhongshan, Guangdong, China

4.2 General Description of EUT

Product Name:	Surround Speaker
Model No.:	U2621, U2523, U2521
Test Model No.:	U2621
Trade Mark:	ULTIMEA
Software Version:	0.1
Hardware Version:	0.2
Operation Frequency:	2402MHz~2480MHz
Bluetooth Version:	V5.4
Modulation Type:	GFSK
Transfer Rate:	1Mbps,2Mbps
Number of Channel:	40
Product Type:	<input checked="" type="checkbox"/> Mobile <input type="checkbox"/> Portable <input type="checkbox"/> Fix Location
Test Software of EUT:	BT_tool
Antenna Type:	PCB antenna
Antenna Gain:	1.19 dBi
Power Supply:	MODEL NO.:FX24U-140100C1 INPUT:100-240V~50/60Hz 0.6A OUTPUT:DC14V= 1.0A
Simultaneous Transmission	<input type="checkbox"/> Simultaneous TX is supported and evaluated in this report. <input checked="" type="checkbox"/> Simultaneous TX is not supported.

Operation Frequency each of channel							
Channel	Frequency	Channel	Frequency	Channel	Frequency	Channel	Frequency
0	2402MHz	10	2422MHz	20	2442MHz	30	2462MHz
1	2404MHz	11	2424MHz	21	2444MHz	31	2464MHz
2	2406MHz	12	2426MHz	22	2446MHz	32	2466MHz
3	2408MHz	13	2428MHz	23	2448MHz	33	2468MHz
4	2410MHz	14	2430MHz	24	2450MHz	34	2470MHz
5	2412MHz	15	2432MHz	25	2452MHz	35	2472MHz
6	2414MHz	16	2434MHz	26	2454MHz	36	2474MHz
7	2416MHz	17	2436MHz	27	2456MHz	37	2476MHz
8	2418MHz	18	2438MHz	28	2458MHz	38	2478MHz
9	2420MHz	19	2440MHz	29	2460MHz	39	2480MHz

Note:

In section 15.31(m), regards to the operating frequency range over 10 MHz, the lowest frequency, the middle frequency, and the highest frequency of channel were selected to perform the test, and the selected channel see below:

Channel	Frequency
The lowest channel (CH0)	2402MHz
The middle channel (CH19)	2440MHz
The highest channel (CH39)	2480MHz

4.3 Additional Instructions

EUT Test Software Settings:		
Mode:	<input checked="" type="checkbox"/> Special software is used. <input type="checkbox"/> Through engineering command into the engineering mode. engineering command: <code>###3646633###</code>	
EUT Power level:	Class2 (Power level is built-in set parameters and cannot be changed and selected)	
Use test software to set the lowest frequency, the middle frequency and the highest frequency keep transmitting of the EUT.		
Mode	Channel	Frequency(MHz)
GFSK	CH0	2402
	CH19	2440
	CH39	2480

Run Software:

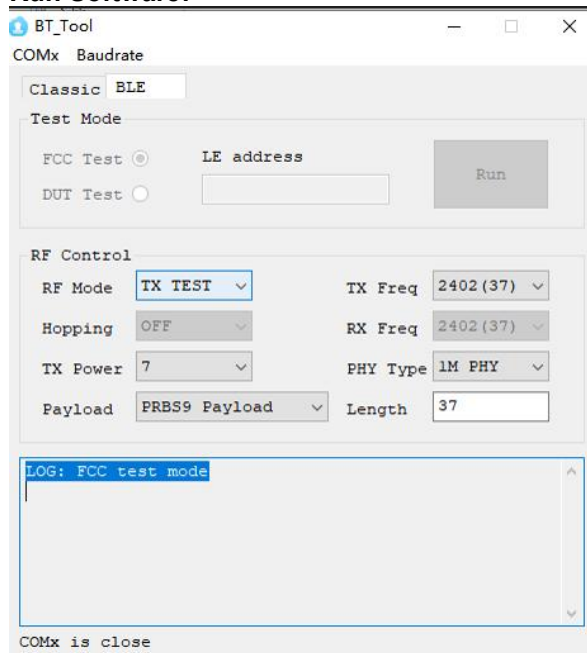

4.4 Test Environment

Operating Environment:	
Temperature:	24.5°C
Humidity:	59% RH
Atmospheric Pressure:	1009mbar
Test Mode:	Use test software to set the lowest frequency, the middle frequency and the highest frequency keep transmitting of the EUT.

4.5 Description of Support Units

The EUT has been tested with associated equipment below.

1) Support equipment

Description	Manufacturer	Model No.	Certification	Supplied by
/	/	/	/	/

2) Cable

Cable No.	Description	Manufacturer	Cable Type/Length	Supplied by
/	/	/	/	/

4.6 Statement of the measurement uncertainty

The data and results referenced in this document are true and accurate.

The reader is cautioned that there may be errors within the calibration limits of the equipment and facilities.

The measurement uncertainty was calculated for all measurements listed in this test report acc. to CISPR 16 - 4 „Specification for radio disturbance and immunity measuring apparatus and methods – Part 4: Uncertainty in EMC Measurements“ and is documented in the **Shenzhen Huaxia Testing Technology Co., Ltd.** quality system acc. to DIN EN ISO/IEC 17025.

Furthermore, component and process variability of devices similar to that tested may result in additional deviation. The manufacturer has the sole responsibility of continued compliance of the device.

Hereafter the best measurement capability for CQA laboratory is reported:

No.	Item	Uncertainty
1	Radiated Emission (Below 1GHz)	5.12dB
2	Radiated Emission (Above 1GHz)	4.60dB
3	Conducted Disturbance (0.15~30MHz)	3.34dB
4	Radio Frequency	3×10^{-8}
5	Duty cycle	0.6 %
6	Occupied Bandwidth	1.1%
7	RF conducted power	0.86dB
8	RF power density	0.74
9	Conducted Spurious emissions	0.86dB
10	Temperature test	0.8°C
11	Humidity test	2.0%
12	Supply voltages	0.5 %
13	Frequency Error	5.5 Hz

4.7 Test Location

All tests were performed at:

Shenzhen Huaxia Testing Technology Co., Ltd.

1F., Block A of Tongsheng Technology Building, Huahui Road, Dalang Street, Longhua District, Shenzhen, China

4.8 Test Facility

- **A2LA (Certificate No. 4742.01)**

Shenzhen Huaxia Testing Technology Co., Ltd., Shenzhen EMC Laboratory is accredited by the American Association for Laboratory Accreditation(A2LA). Certificate No. 4742.01.

- **FCC Registration No.: 522263**

Shenzhen Huaxia Testing Technology Co., Ltd., Shenzhen EMC Laboratory has been registered and fully described in a report filed with the (FCC) Federal Communications Commission. The acceptance letter from the FCC is maintained in our files. Registration No.:522263

4.9 Deviation from Standards

None.

4.10 Other Information Requested by the Customer

None.

4.11 Equipment List

Test Equipment	Manufacturer	Model No.	Instrument No.	Calibration Date	Calibration Due Date
EMI Test Receiver	R&S	ESR7	CQA-005	2023/09/08	2024/09/07
Spectrum analyzer	R&S	FSU26	CQA-038	2023/09/08	2024/09/07
Spectrum analyzer	R&S	FSU40	CQA-075	2023/09/08	2024/09/07
Preamplifier	MITEQ	AFS4-00010300-18-10P-4	CQA-035	2023/09/08	2024/09/07
Preamplifier	MITEQ	AMF-6D-02001800-29-20P	CQA-036	2023/09/08	2024/09/07
Preamplifier	EMCI	EMC184055SE	CQA-089	2023/09/08	2024/09/07
Loop antenna	Schwarzbeck	FMZB1516	CQA-060	2021/09/16	2024/09/15
Bilog Antenna	R&S	HL562	CQA-011	2021/09/16	2024/09/15
Horn Antenna	R&S	HF906	CQA-012	2021/09/16	2024/09/15
Horn Antenna	Schwarzbeck	BBHA 9170	CQA-088	2021/09/16	2024/09/15
Coaxial Cable (Above 1GHz)	CQA	N/A	C007	2023/09/08	2024/09/07
Coaxial Cable (Below 1GHz)	CQA	N/A	C013	2023/09/08	2024/09/07
RF cable(9KHz~40GHz)	CQA	RF-01	CQA-079	2023/09/08	2024/09/07
Antenna Connector	CQA	RFC-01	CQA-080	2023/09/08	2024/09/07
Power Sensor	KEYSIGHT	U2021XA	CQA-30	2023/09/08	2024/09/07
N1918A Power Analysis Manager Power Panel	Agilent	N1918A	CQA-074	2023/09/08	2024/09/07
Power meter	R&S	NRVD	CQA-029	2023/09/08	2024/09/07
Power divider	MIDWEST	PWD-2533-02-SMA-79	CQA-067	2023/09/08	2024/09/07
EMI Test Receiver	R&S	ESR7	CQA-005	2023/09/08	2024/09/07
LISN	R&S	ENV216	CQA-003	2023/09/08	2024/09/07
Coaxial cable	CQA	N/A	CQA-C009	2023/09/08	2024/09/07
DC power	KEYSIGHT	E3631A	CQA-028	2023/09/08	2024/09/07

Note:

The temporary antenna connector is soldered on the pcb board in order to perform conducted tests and this temporary antenna connector is listed in the equipment list.

5 Test results and Measurement Data

5.1 Antenna Requirement

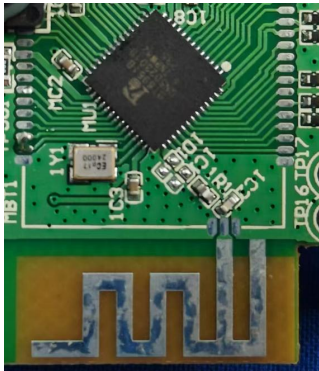
Standard requirement:	47 CFR Part 15C Section 15.203 /247(c)
<p>15.203 requirement: An intentional radiator shall be designed to ensure that no antenna other than that furnished by the responsible party shall be used with the device. The use of a permanently attached antenna or of an antenna that uses a unique coupling to the intentional radiator, the manufacturer may design the unit so that a broken antenna can be replaced by the user, but the use of a standard antenna jack or electrical connector is prohibited.</p> <p>15.247(b) (4) requirement: The conducted output power limit specified in paragraph (b) of this section is based on the use of antennas with directional gains that do not exceed 6 dBi. Except as shown in paragraph (c) of this section, if transmitting antennas of directional gain greater than 6 dBi are used, the conducted output power from the intentional radiator shall be reduced below the stated values in paragraphs (b)(1), (b)(2), and (b)(3) of this section, as appropriate, by the amount in dB that the directional gain of the antenna exceeds 6 dBi.</p>	
EUT Antenna:	
<p>The antenna is PCB antenna. The connection/connection type between the antenna to the EUT's antenna port is: permanently attachment This is either permanently attachment or a unique coupling that satisfies the requirement.</p>	

5.2 Conducted Emissions

Test Requirement:	47 CFR Part 15C Section 15.207		
Test Method:	ANSI C63.10: 2013		
Test Frequency Range:	150kHz to 30MHz		
Limit:	Frequency range (MHz)	Limit (dBuV)	
		Quasi-peak	Average
	0.15-0.5	66 to 56*	56 to 46*
	0.5-5	56	46
	5-30	60	50
	* Decreases with the logarithm of the frequency.		
Test Procedure:	<ol style="list-style-type: none"> 1) The mains terminal disturbance voltage test was conducted in a shielded room. 2) The EUT was connected to AC power source through a LISN 1 (Line Impedance Stabilization Network) which provides a 50Ω/50μH + 5Ω linear impedance. The power cables of all other units of the EUT were connected to a second LISN 2, which was bonded to the ground reference plane in the same way as the LISN 1 for the unit being measured. A multiple socket outlet strip was used to connect multiple power cables to a single LISN provided the rating of the LISN was not exceeded. 3) The tabletop EUT was placed upon a non-metallic table 0.8m above the ground reference plane. And for floor-standing arrangement, the EUT was placed on the horizontal ground reference plane, 4) The test was performed with a vertical ground reference plane. The rear of the EUT shall be 0.4 m from the vertical ground reference plane. The vertical ground reference plane was bonded to the horizontal ground reference plane. The LISN 1 was placed 0.8 m from the boundary of the unit under test and bonded to a ground reference plane for LISNs mounted on top of the ground reference plane. This distance was between the closest points of the LISN 1 and the EUT. All other units of the EUT and associated equipment was at least 0.8 m from the LISN 2. 5) In order to find the maximum emission, the relative positions of equipment and all of the interface cables must be changed according to ANSI C63.10: 2013 on conducted measurement. 		

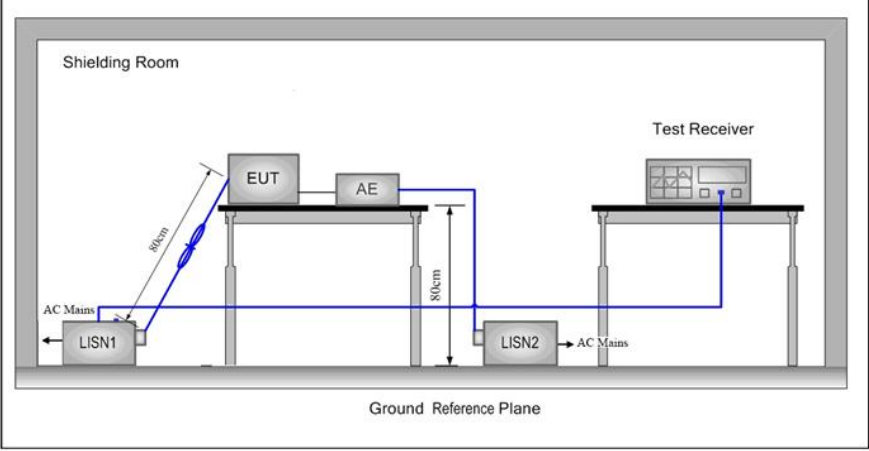
<p>Test Setup:</p>	
<p>Test Mode:</p>	<p>Through Pre-scan, find the transmitting mode at the lowest channel is the worst case.</p>
<p>Test Voltage:</p>	<p>AC 120V/60Hz</p>
<p>Test Results:</p>	<p>Pass</p>

Measurement Data

Live line:

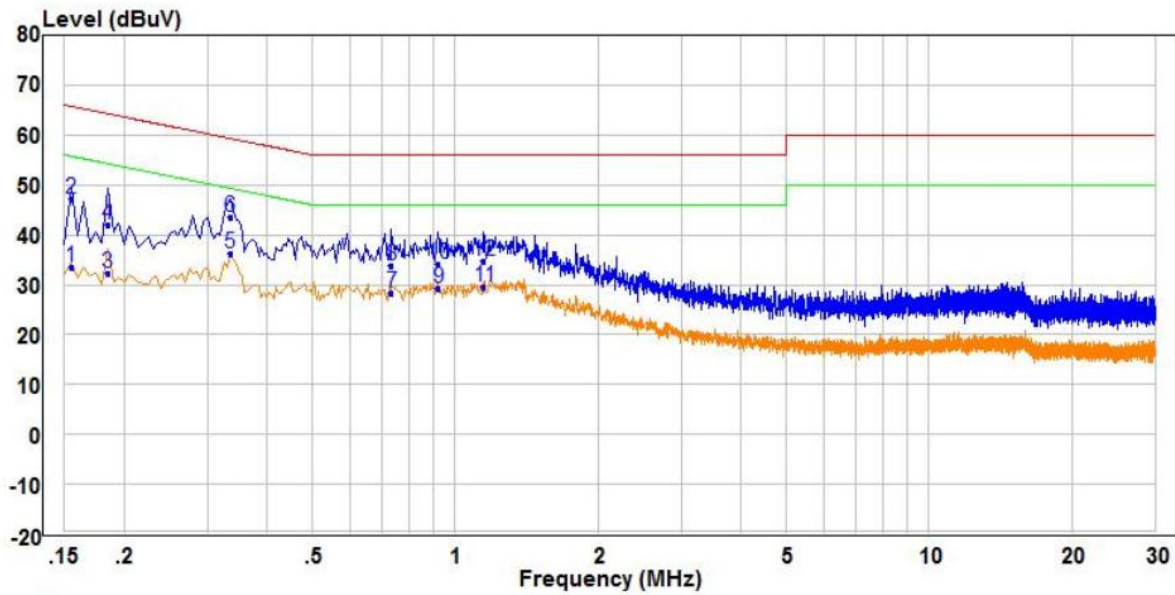

	Read Freq	Read Level	Factor	Level	Limit Line	Over Limit	Remark	Pol/Phase
	MHz	dBuV	dB	dBuV	dBuV	dB		
1	0.155	23.95	9.49	33.44	55.73	-22.29	Average	Line
2	0.155	37.58	9.49	47.07	65.73	-18.66	QP	Line
3	0.185	22.76	9.49	32.25	54.26	-22.01	Average	Line
4	0.185	32.57	9.49	42.06	64.26	-22.20	QP	Line
5 PP	0.335	26.64	9.50	36.14	49.33	-13.19	Average	Line
6 QP	0.335	34.04	9.50	43.54	59.33	-15.79	QP	Line
7	0.735	18.49	9.83	28.32	46.00	-17.68	Average	Line
8	0.735	23.85	9.83	33.68	56.00	-22.32	QP	Line
9	0.920	19.51	9.61	29.12	46.00	-16.88	Average	Line
10	0.920	24.48	9.61	34.09	56.00	-21.91	QP	Line
11	1.150	20.00	9.53	29.53	46.00	-16.47	Average	Line
12	1.150	25.26	9.53	34.79	56.00	-21.21	QP	Line

Remark:

1. The following Quasi-Peak and Average measurements were performed on the EUT:
2. Final Test Level = Receiver Reading + LISN Factor + Cable Loss.
3. If the Peak value under Average limit, the Average value is not recorded in the report.

Neutral line:

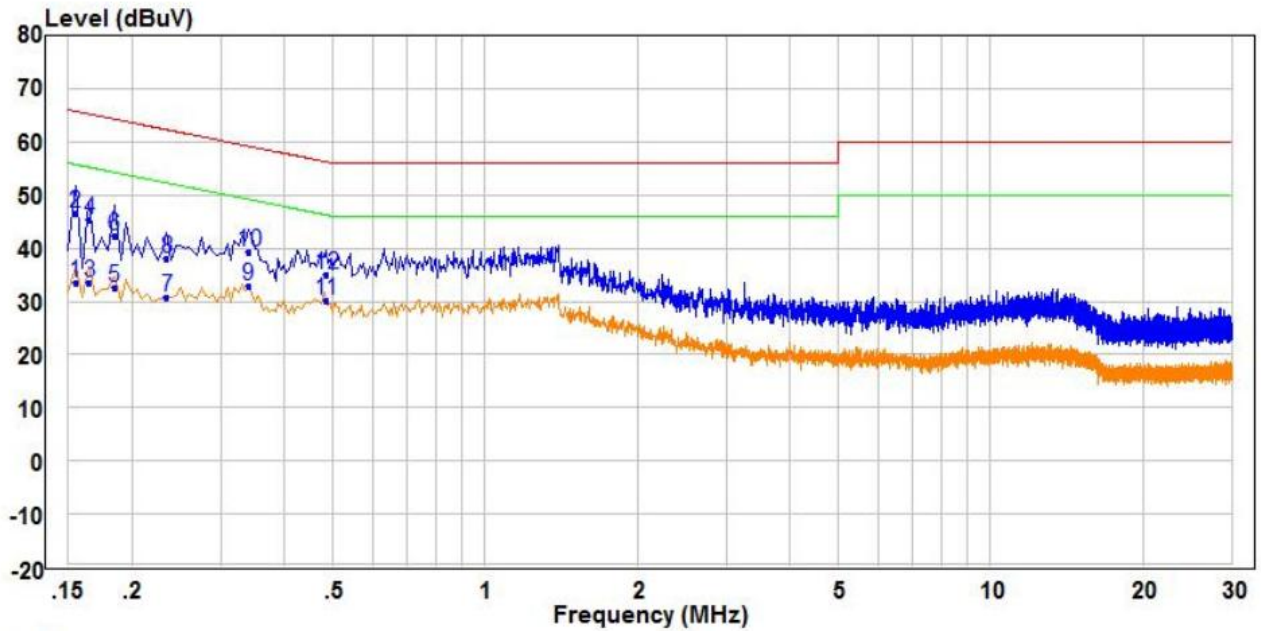

	Read Freq	Read Level	Factor	Level	Limit Line	Over Limit	Remark	Pol/Phase	
	MHz	dBuV	dB	dBuV	dBuV	dB			
1	0.155	23.92	9.69	33.61	55.73	-22.12	Average	Neutral	
2	QP	0.155	36.94	9.69	46.63	65.73	-19.10	QP	Neutral
3	0.165	23.88	9.67	33.55	55.21	-21.66	Average	Neutral	
4	0.165	35.69	9.67	45.36	65.21	-19.85	QP	Neutral	
5	0.185	22.90	9.63	32.53	54.26	-21.73	Average	Neutral	
6	0.185	32.73	9.63	42.36	64.26	-21.90	QP	Neutral	
7	0.235	21.34	9.56	30.90	52.27	-21.37	Average	Neutral	
8	0.235	28.38	9.56	37.94	62.27	-24.33	QP	Neutral	
9	0.340	23.37	9.53	32.90	49.20	-16.30	Average	Neutral	
10	0.340	29.78	9.53	39.31	59.20	-19.89	QP	Neutral	
11	PP	0.485	20.53	9.69	30.22	46.25	-16.03	Average	Neutral
12	0.485	25.43	9.69	35.12	56.25	-21.13	QP	Neutral	

Remark:

1. The following Quasi-Peak and Average measurements were performed on the EUT:
2. Final Test Level = Receiver Reading + LISN Factor + Cable Loss.
3. If the Peak value under Average limit, the Average value is not recorded in the report.

5.3 Conducted Peak Output Power

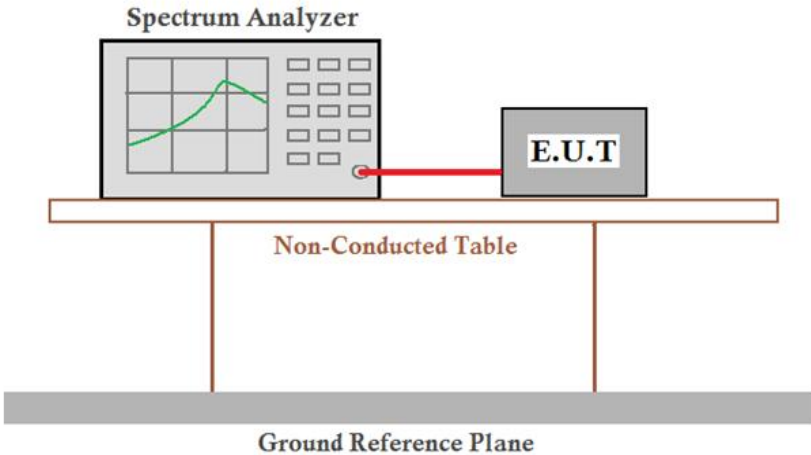
Test Requirement:	47 CFR Part 15C Section 15.247 (b)(3)
Test Method:	ANSI C63.10 2013
Test Setup:	 <p style="text-align: center;"><i>Remark: Offset=Cable loss+ attenuation factor.</i></p>
Limit:	30dBm
Test Mode:	Transmitting with GFSK modulation.
Test Results:	Pass

Measurement Data

GFSK mode (1Mbps)			
Test channel	Peak Output Power (dBm)	Limit (dBm)	Result
Lowest	1.08	30.00	Pass
Middle	0.51	30.00	Pass
Highest	0.98	30.00	Pass
GFSK mode (2Mbps)			
Test channel	Peak Output Power (dBm)	Limit (dBm)	Result
Lowest	1.08	30.00	Pass
Middle	0.51	30.00	Pass
Highest	0.98	30.00	Pass

BLE 1M Ant1 2402

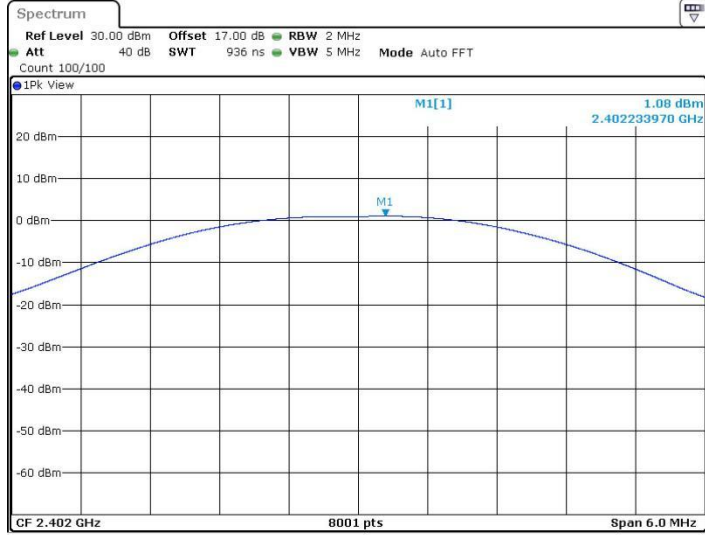

Date: 28.AUG.2024 18:34:25

BLE 1M Ant1 2440

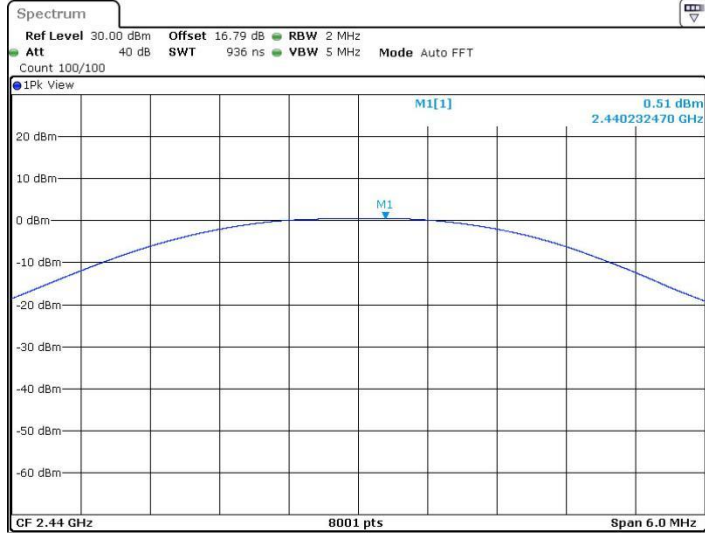

Date: 28.AUG.2024 18:39:39

BLE 1M Ant1 2480



Date: 28.AUG.2024 18:41:32

BLE 2M Ant1 2402

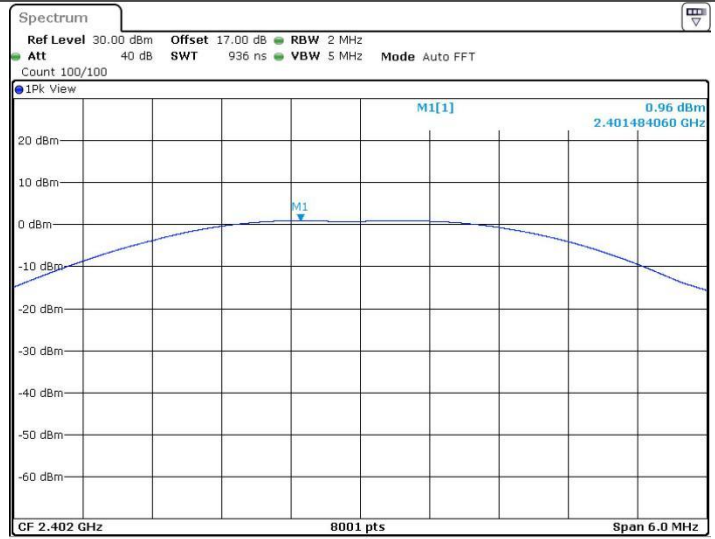

Date: 28.AUG.2024 18:44:36

BLE 2M Ant1 2440

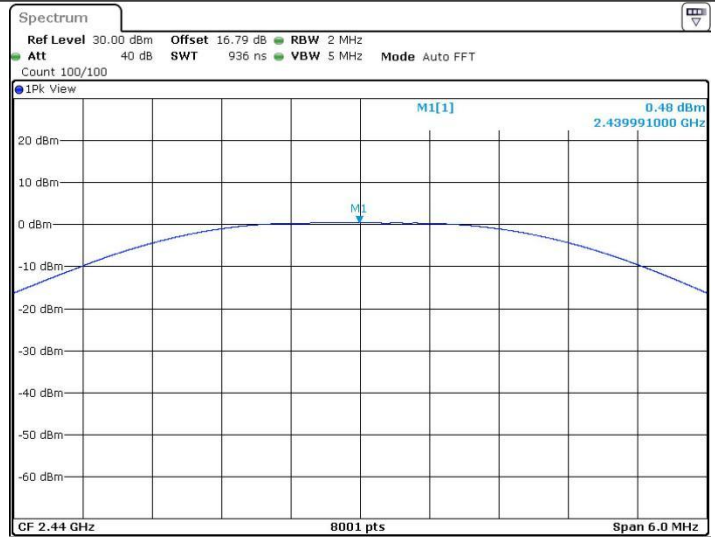

Date: 28.AUG.2024 18:49:45

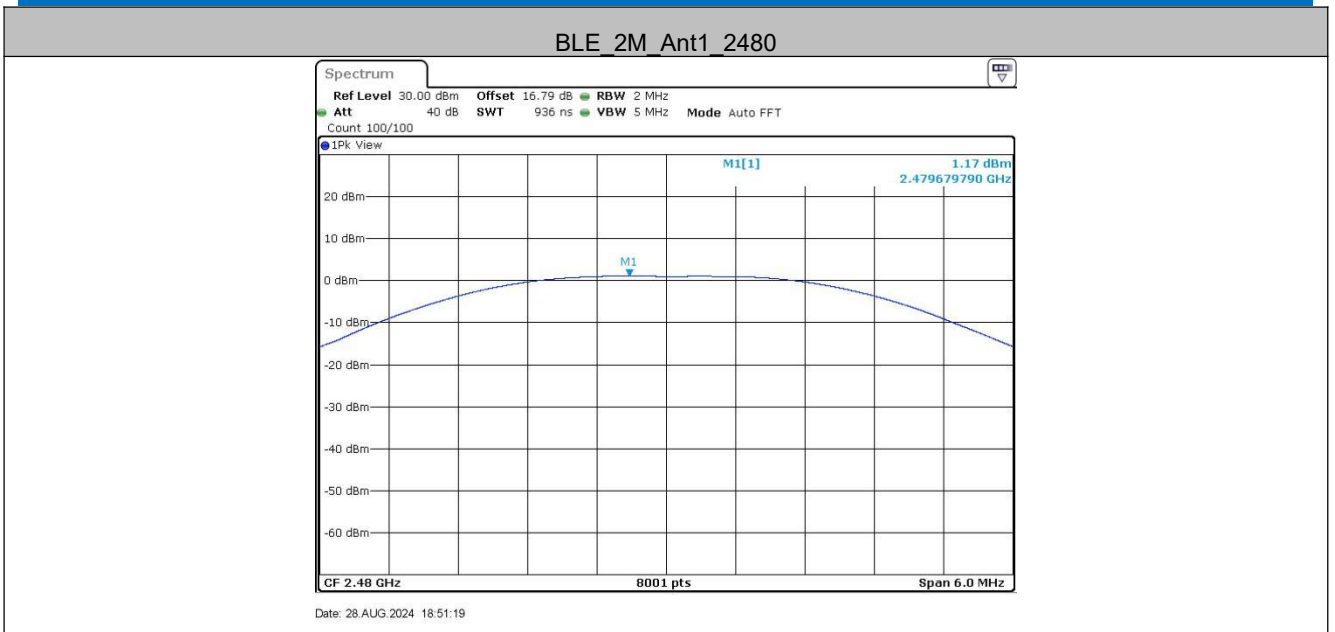

5.4 6dB Occupy Bandwidth

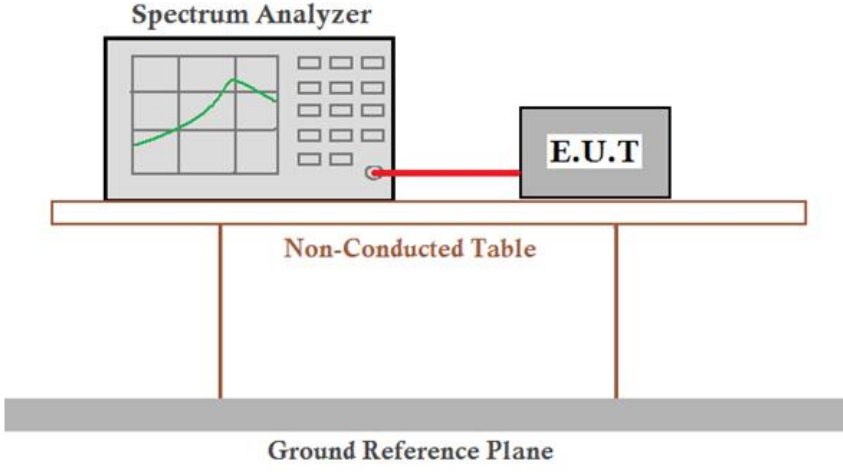
Test Requirement:	47 CFR Part 15C Section 15.247 (a)(2)
Test Method:	ANSI C63.10 2013
Test Setup:	 <p style="text-align: center;"><i>Remark: Offset=Cable loss+ attenuation factor.</i></p>
Limit:	≥ 500 kHz
Instruments Used:	Refer to section 4.11 for details.
Test Results:	Pass

Measurement Data

GFSK mode (1Mbps)			
Test channel	6dB Occupy Bandwidth (MHz)	Limit (kHz)	Result
Lowest	0.66	≥500	Pass
Middle	0.65	≥500	Pass
Highest	0.66	≥500	Pass
GFSK mode (2Mbps)			
Test channel	6dB Occupy Bandwidth (MHz)	Limit (kHz)	Result
Lowest	1.14	≥500	Pass
Middle	1.14	≥500	Pass
Highest	1.14	≥500	Pass

BLE 1M Ant1 2402

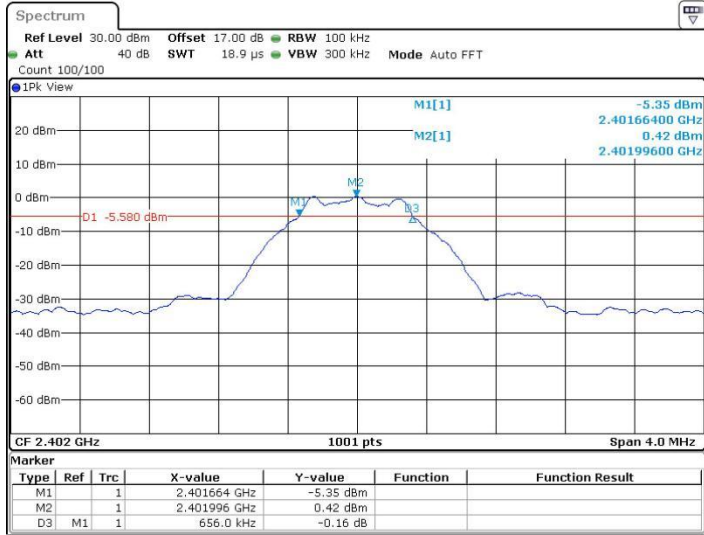

Date: 28.AUG.2024 18:34:11

BLE 1M Ant1 2440

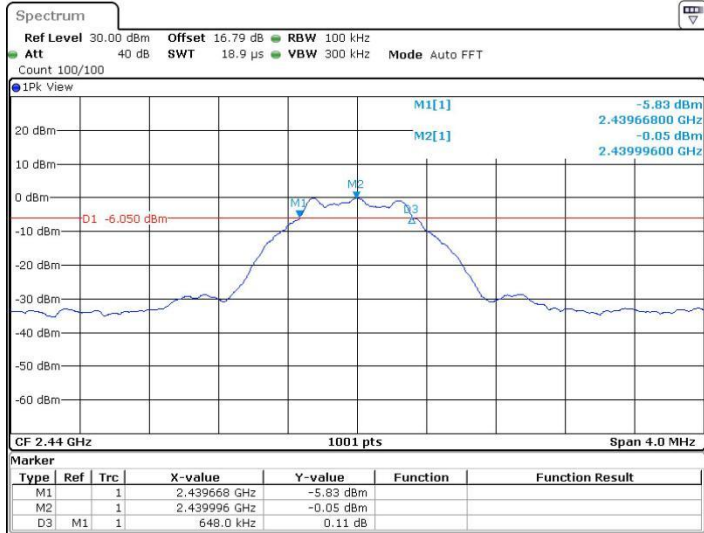

Date: 28.AUG.2024 18:39:25

BLE 1M Ant1 2480

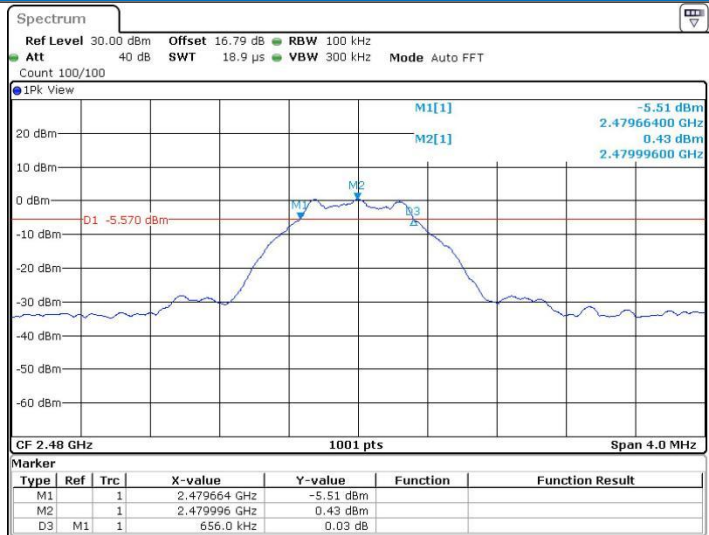

Date: 28 AUG 2024 18:41:18

BLE 2M Ant1 2402

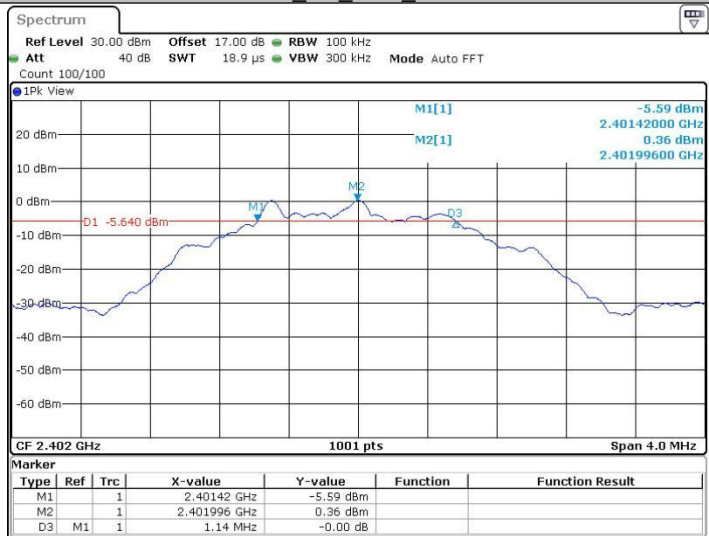

Date: 28 AUG 2024 18:44:23

BLE 2M Ant1 2440

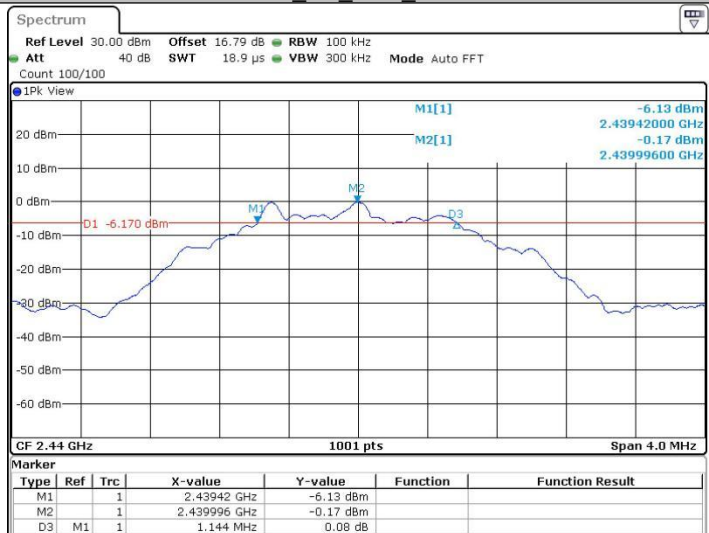

Date: 28 AUG 2024 18:49:32

BLE 2M Ant1 2480

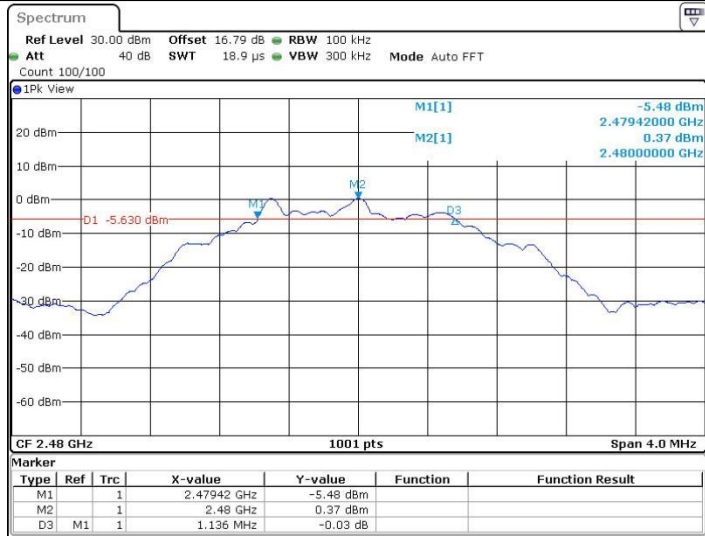

Date: 28.AUG.2024 18:51:05

5.5 Power Spectral Density

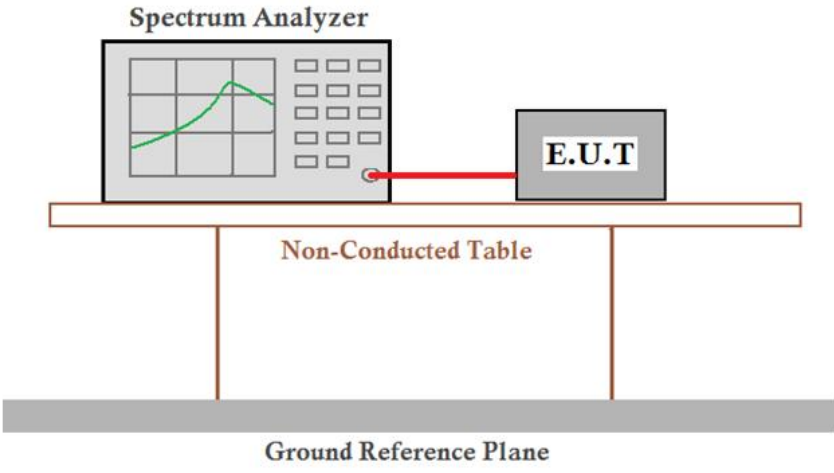
Test Requirement:	47 CFR Part 15C Section 15.247 (e)
Test Method:	ANSI C63.10 2013
Test Setup:	 <p style="text-align: center;"><i>Remark: Offset=Cable loss+ attenuation factor.</i></p>
Limit:	≤8.00dBm/3kHz
Test Mode:	Transmitting with GFSK modulation.
Test Results:	Pass

Measurement Data

GFSK mode (1Mbps)			
Test channel	Power Spectral Density (dBm/3kHz)	Limit (dBm/3kHz)	Result
Lowest	-14.75	≤8.00	Pass
Middle	-15.09	≤8.00	Pass
Highest	-14.79	≤8.00	Pass
GFSK mode (2Mbps)			
Test channel	Power Spectral Density (dBm/3kHz)	Limit (dBm/3kHz)	Result
Lowest	-17.18	≤8.00	Pass
Middle	-17.49	≤8.00	Pass
Highest	-17.22	≤8.00	Pass

Test plot as follows:

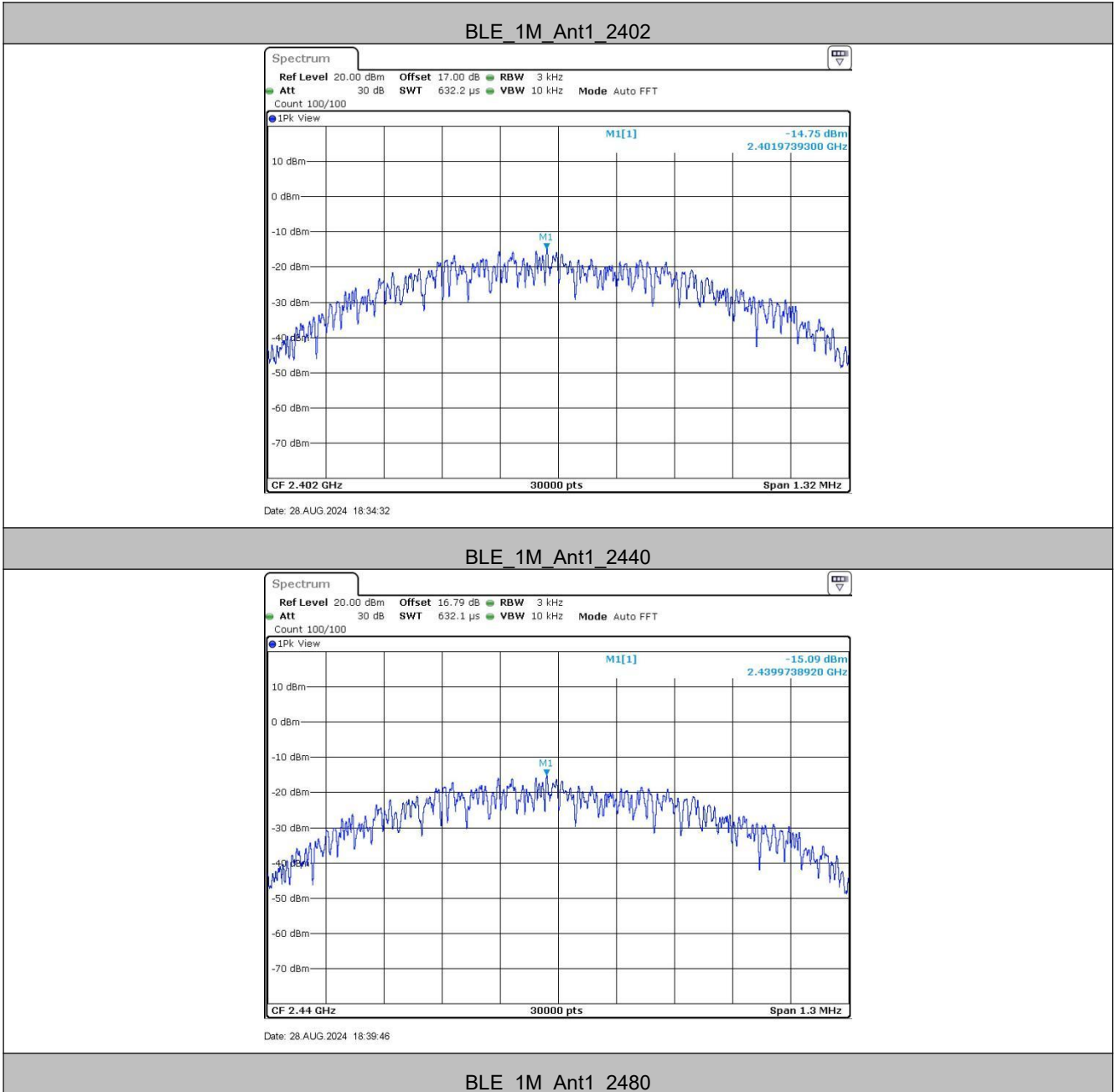

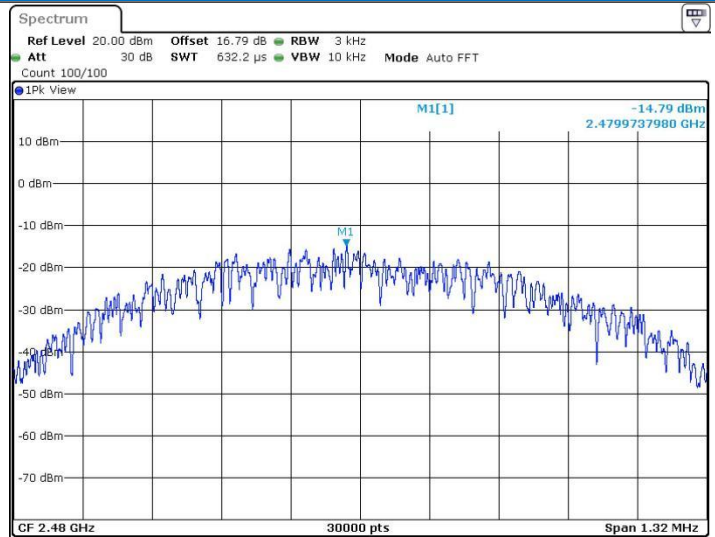

Date: 28.AUG.2024 18:41:39

BLE 2M Ant1 2402

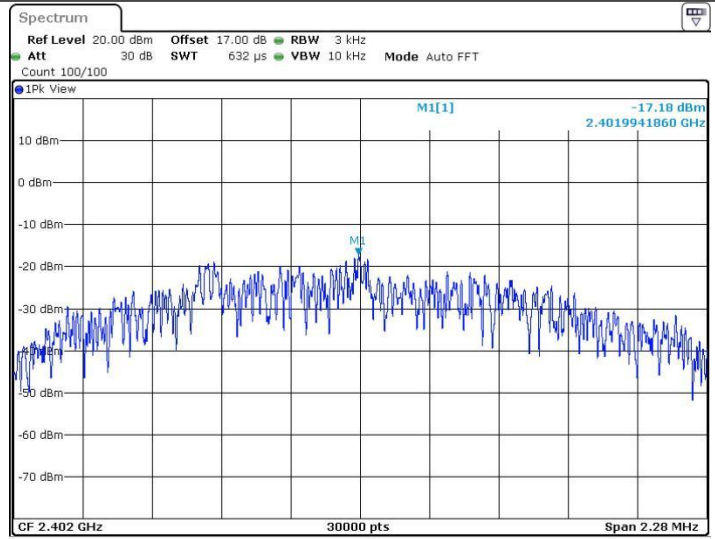

Date: 28.AUG.2024 18:44:44

BLE 2M Ant1 2440

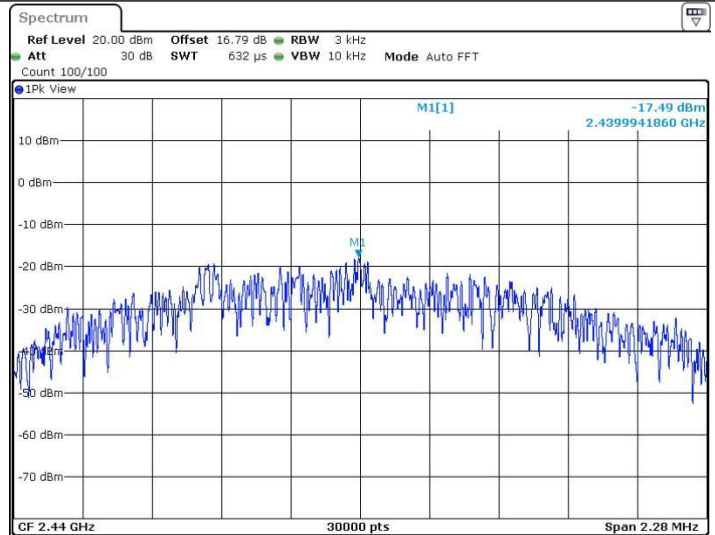

Date: 28.AUG.2024 18:49:53

BLE 2M Ant1 2480

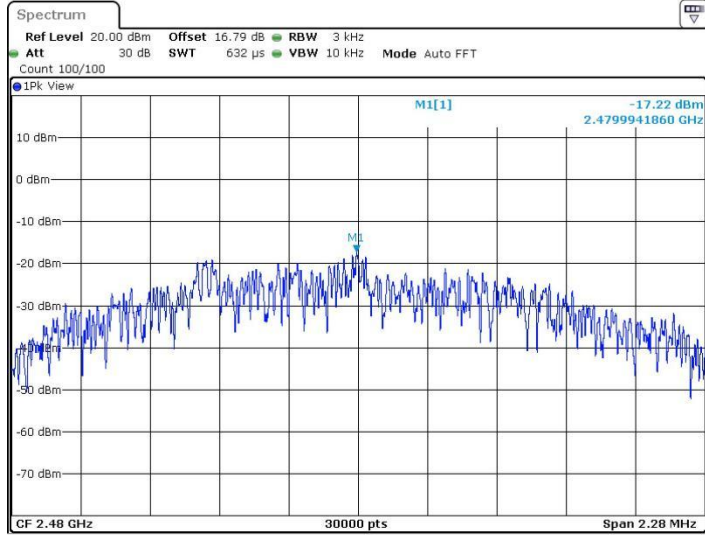

Date: 28.AUG.2024 18:51:26

5.6 Band-edge for RF Conducted Emissions

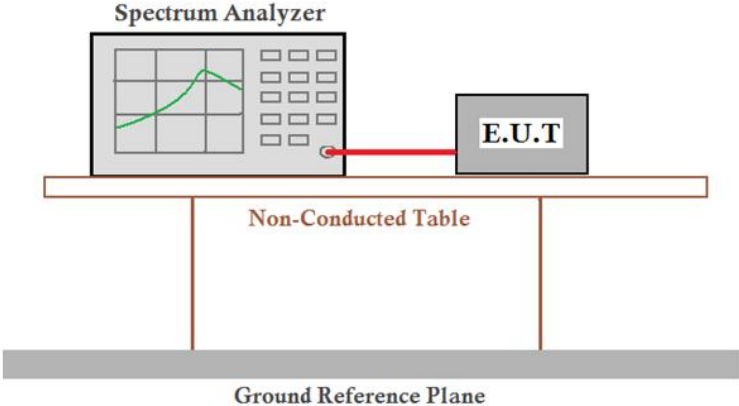
Test Requirement:	47 CFR Part 15C Section 15.247 (d)
Test Method:	ANSI C63.10 2013
Test Setup:	 <p style="text-align: center;">Remark: $Offset = \text{Cable loss} + \text{attenuation factor}$.</p>
Limit:	In any 100 kHz bandwidth outside the frequency band in which the spread spectrum intentional radiator is operating, the radio frequency power that is produced by the intentional radiator shall be at least 20 dB below that in the 100 kHz bandwidth within the band that contains the highest level of the desired power, based on either an RF conducted or a radiated measurement.
Test Mode:	Transmitting with GFSK modulation.
Test Results:	Pass

TestMode	ChName	Freq(MHz)	RefLevel[dBm]	Result[dBm]	Limit[dBm]	Verdict
BLE_1M	Low	2402	0.43	-41.61	≤-19.57	PASS
	High	2480	0.29	-41.21	≤-19.71	PASS
BLE_2M	Low	2402	0.43	-32.13	≤-19.57	PASS
	High	2480	0.29	-40.66	≤-19.71	PASS

Test plot as follows:

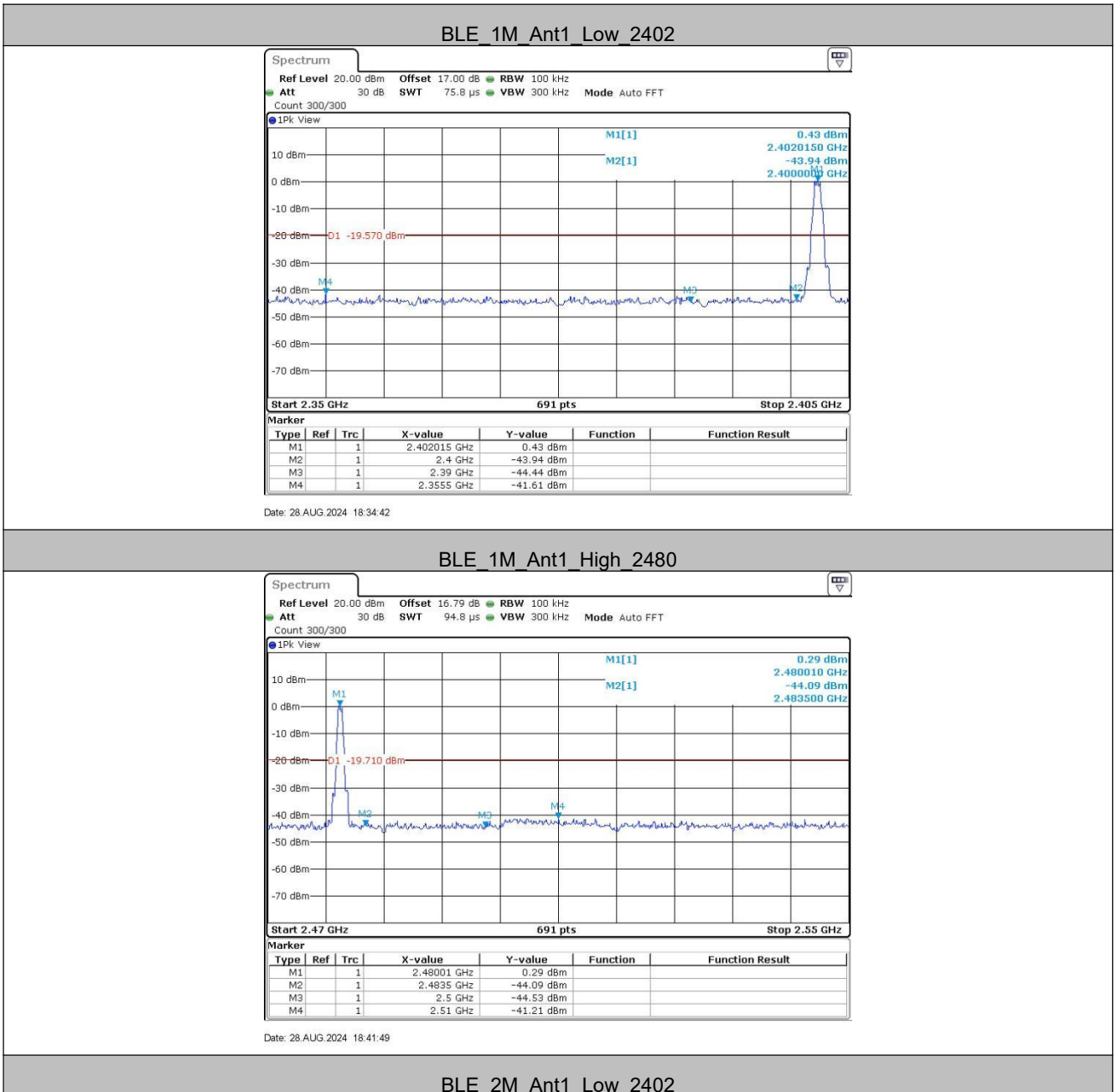

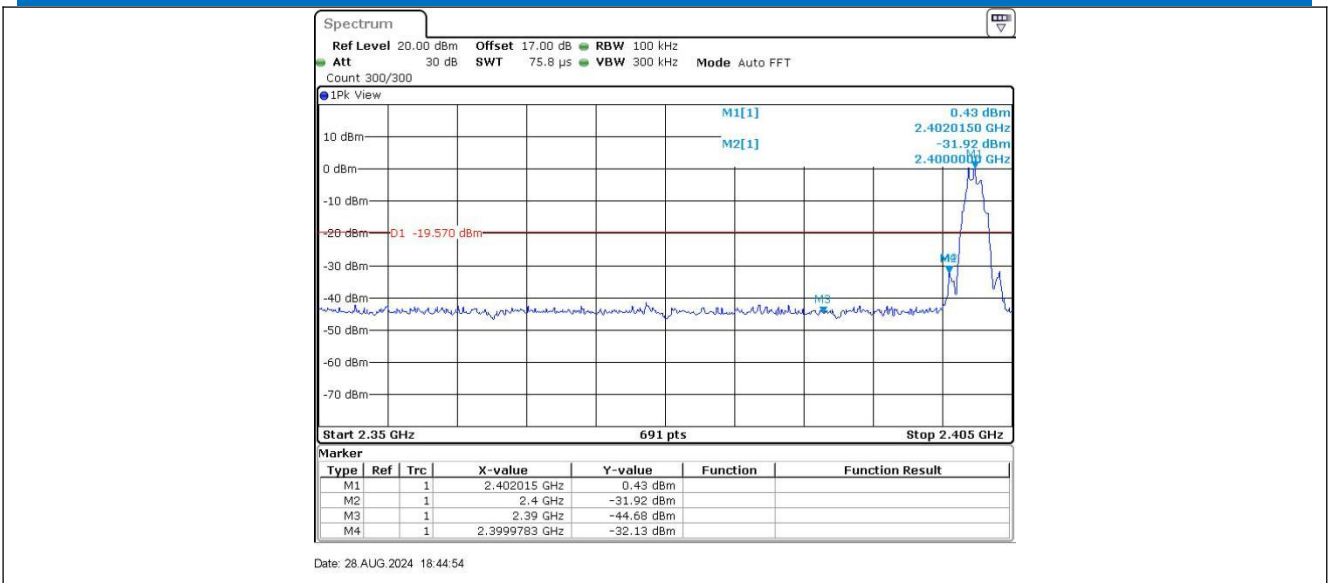

BLE 2M Ant1 High 2480

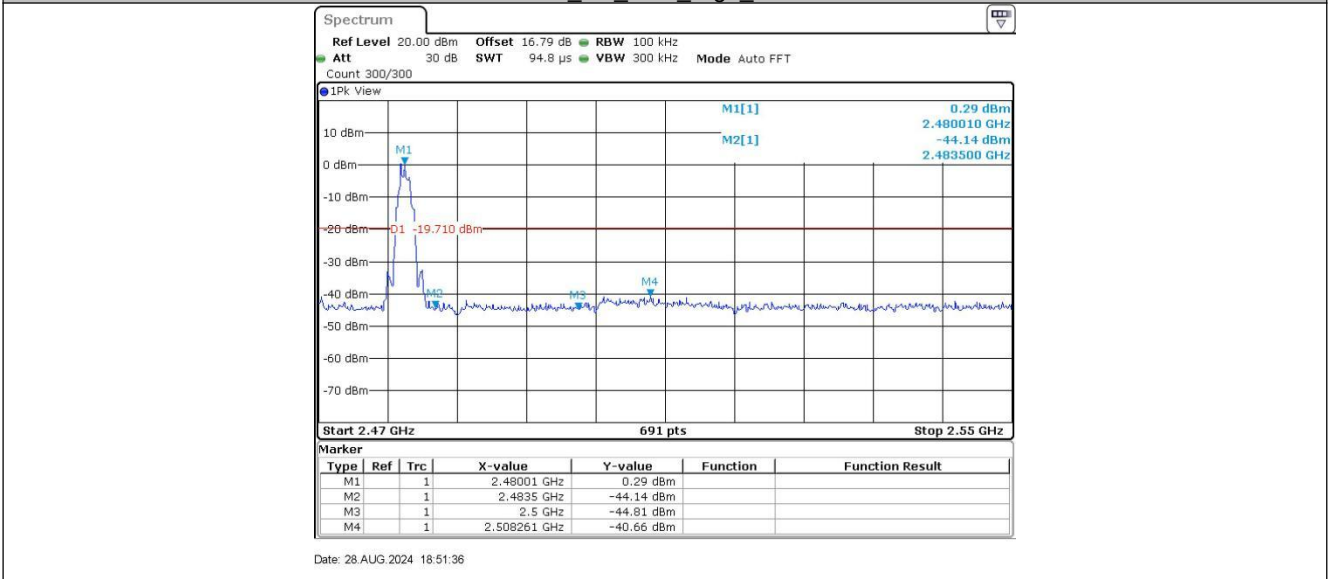

5.7 Spurious RF Conducted Emissions

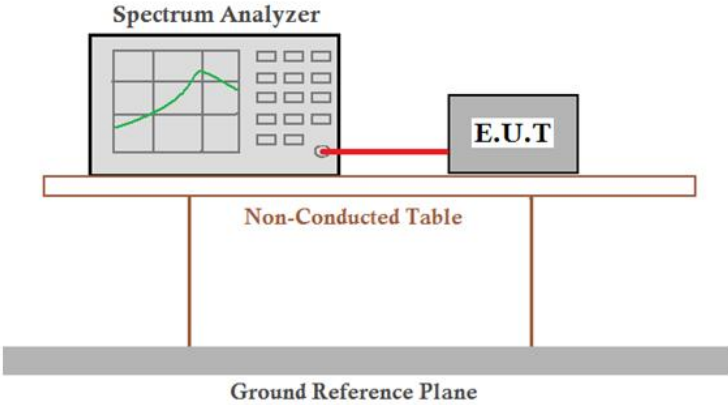
Test Requirement:	47 CFR Part 15C Section 15.247 (d)
Test Method:	ANSI C63.10 2013
Test Setup:	 <p style="text-align: center;"><i>Remark: Offset=Cable loss+ attenuation factor.</i></p>
Limit:	In any 100 kHz bandwidth outside the frequency band in which the spread spectrum intentional radiator is operating, the radio frequency power that is produced by the intentional radiator shall be at least 20 dB below that in the 100 kHz bandwidth within the band that contains the highest level of the desired power, based on either an RF conducted or a radiated measurement.
Test Mode:	Transmitting with GFSK modulation.
Test Results:	Pass

Test plot as follows:

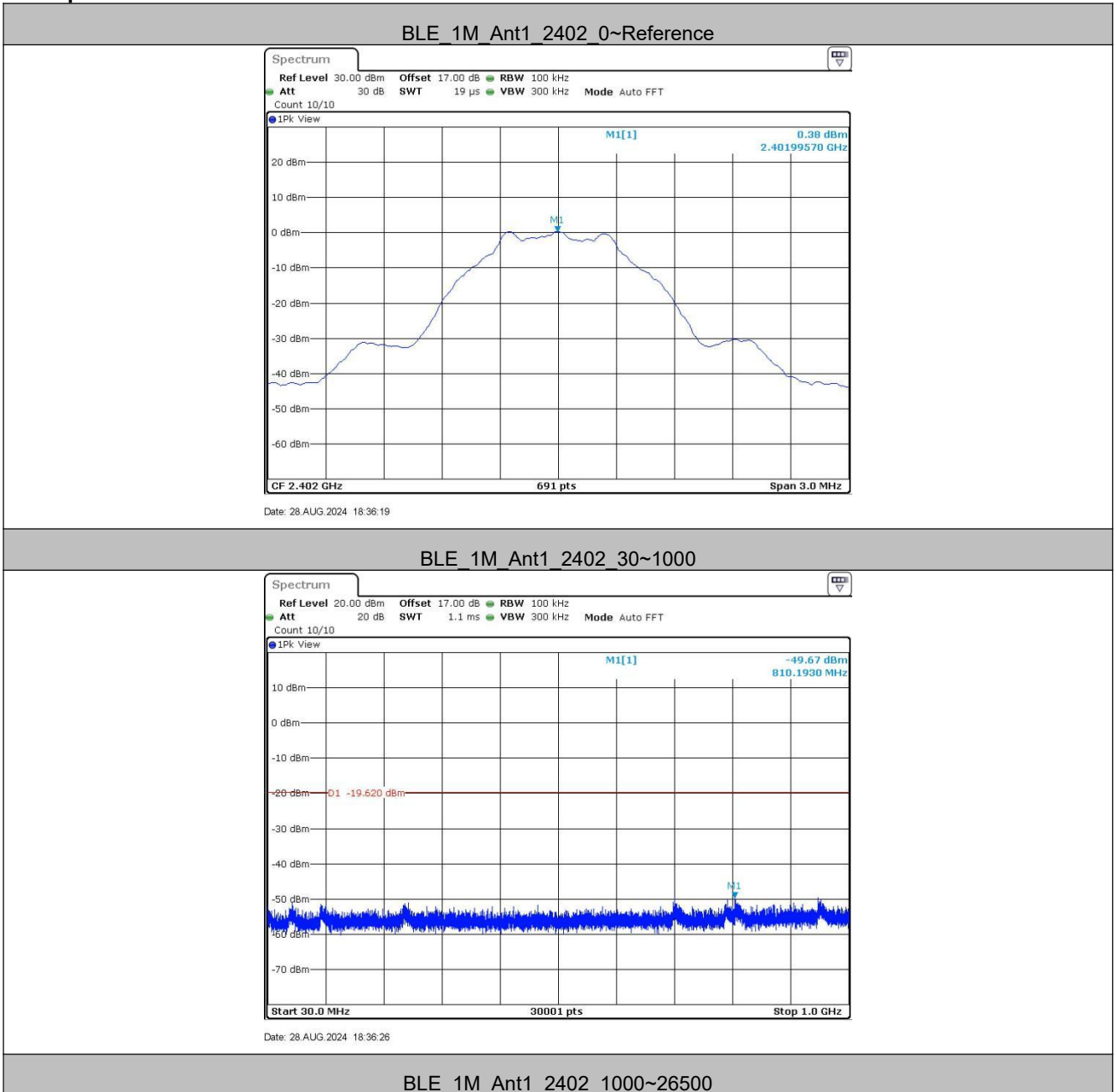

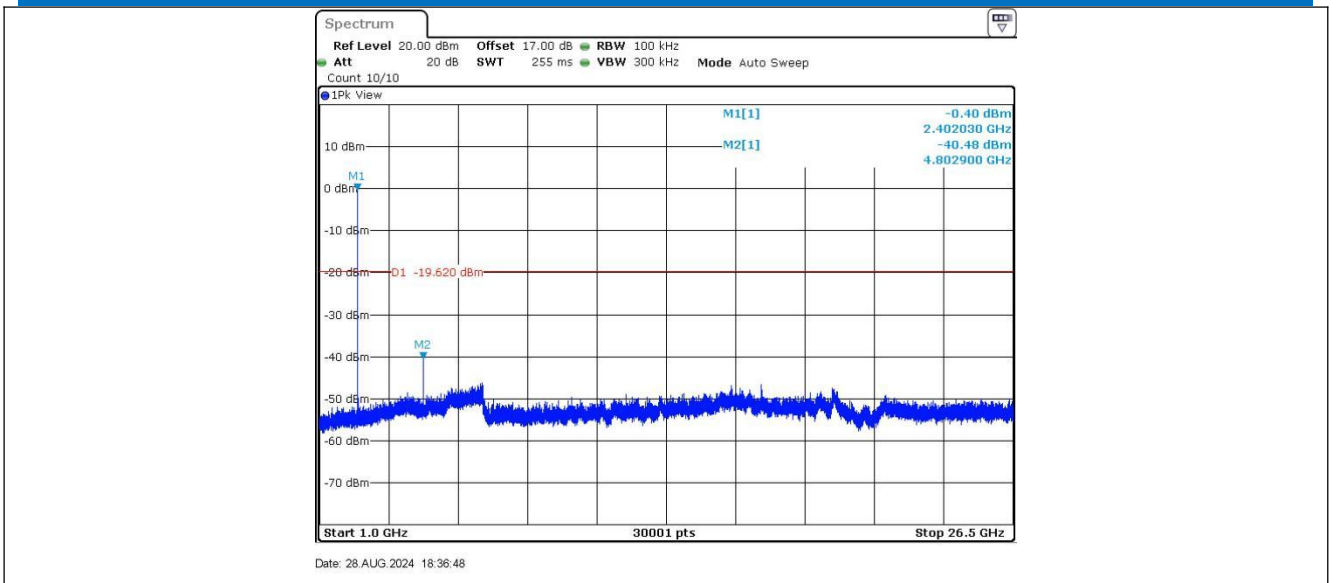

BLE_1M_Ant1_2440_0~Reference



BLE_1M_Ant1_2440_30~1000

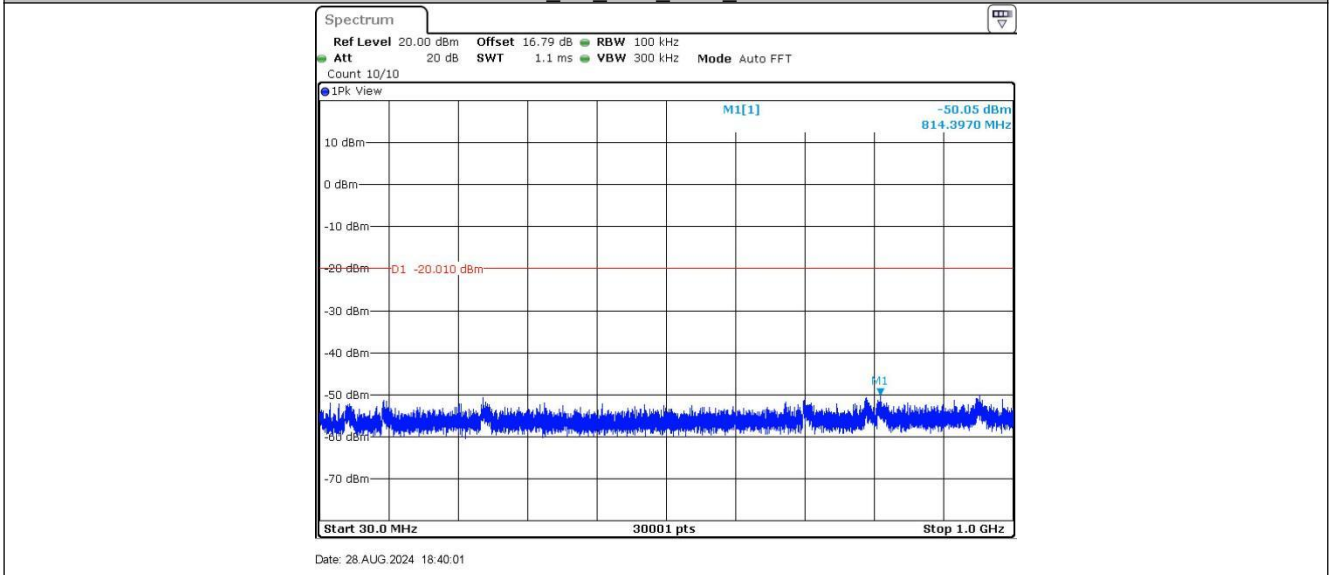

BLE 1M Ant1 2440 1000~26500

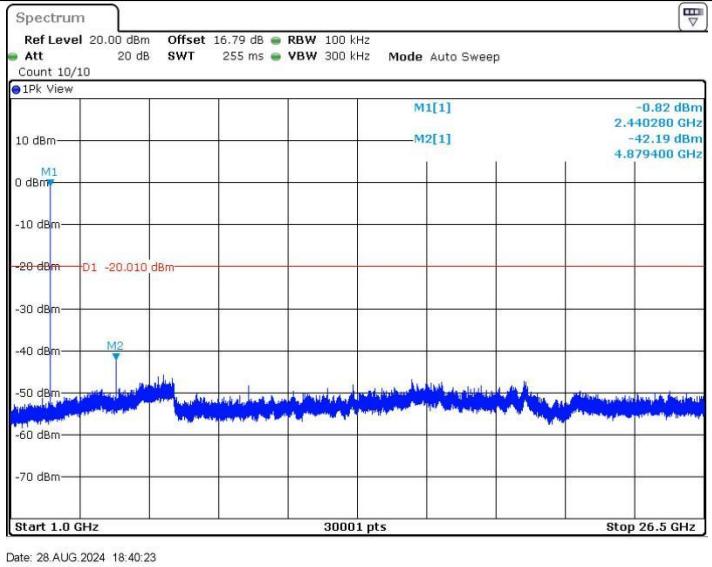

BLE 1M Ant1 2480 0~Reference

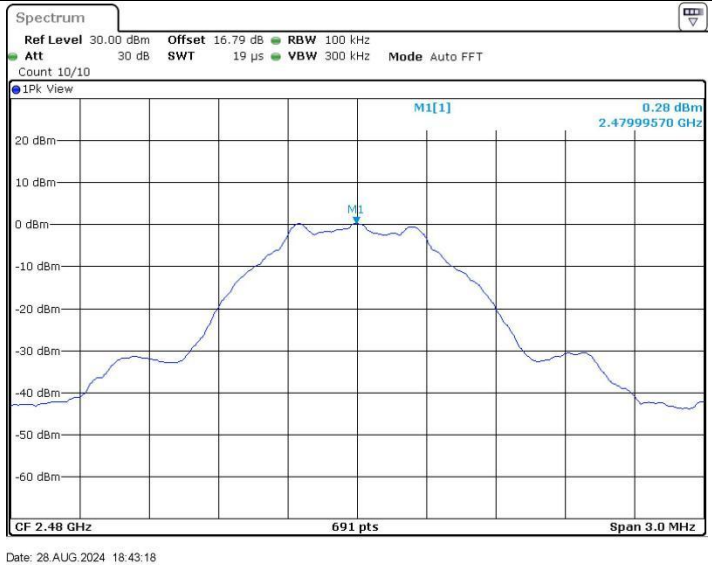

BLE 1M Ant1 2480 30~1000

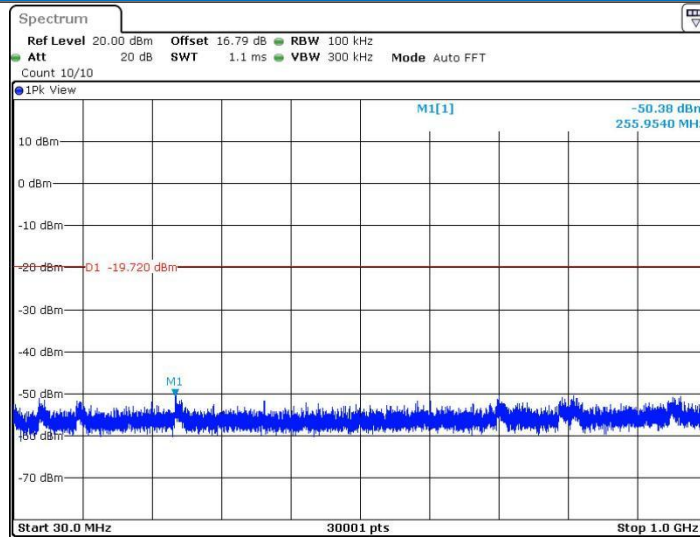

Date: 28 AUG 2024 18:43:24

BLE 1M Ant1_2480_1000~26500

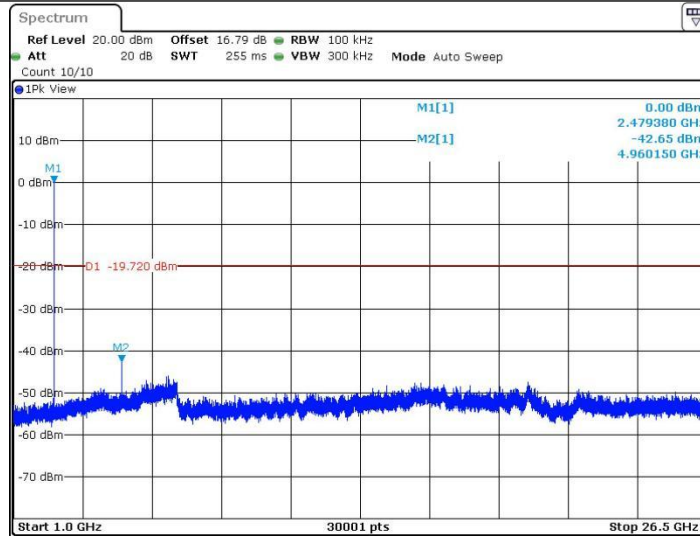

Date: 28 AUG 2024 18:43:46

BLE 2M Ant1_2402_0~Reference



Date: 28 AUG 2024 18:46:47

BLE 2M Ant1_2402_30~1000

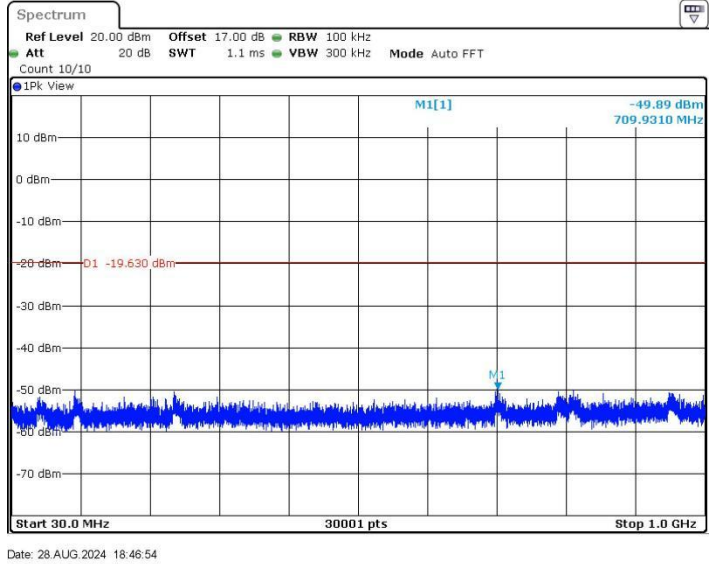

BLE 2M Ant1_2402_1000~26500

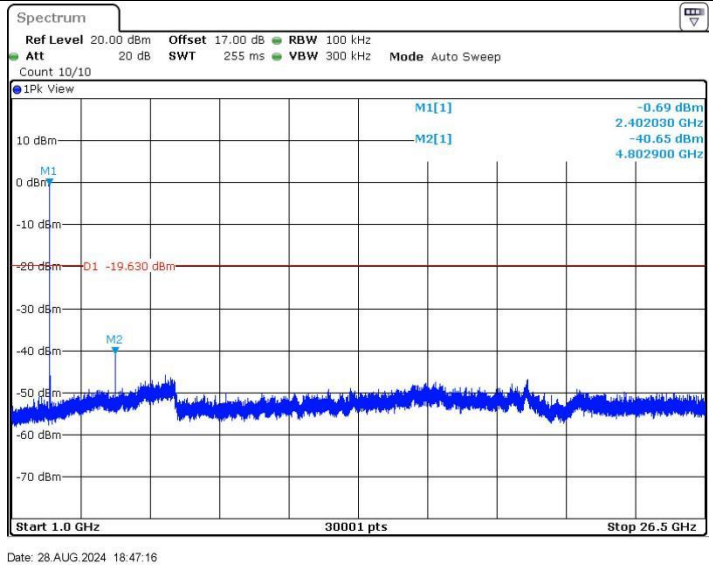

BLE 2M Ant1_2440_0~Reference



Date: 28 AUG 2024 18:50:01

BLE_2M_Ant1_2440_30~1000

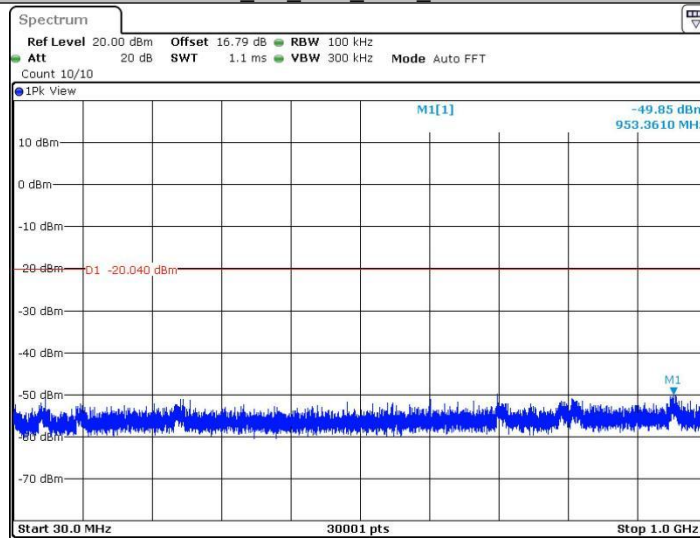

Date: 28 AUG 2024 18:50:07

BLE_2M_Ant1_2440_1000~26500

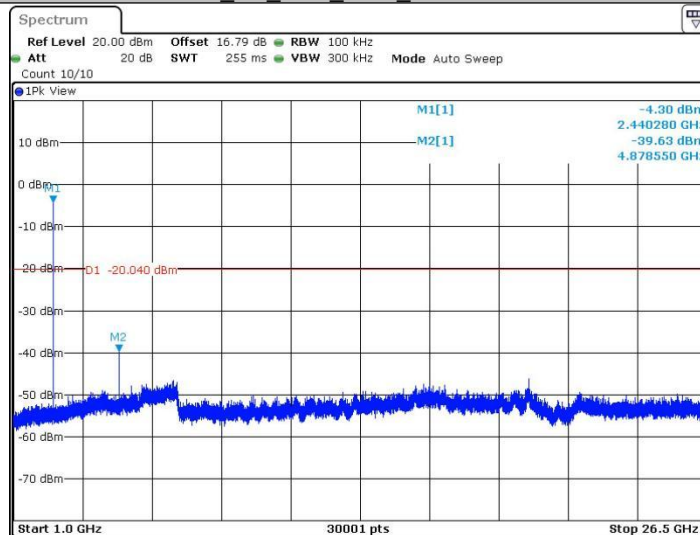

Date: 28 AUG 2024 18:50:30

BLE_2M_Ant1_2480_0~Reference

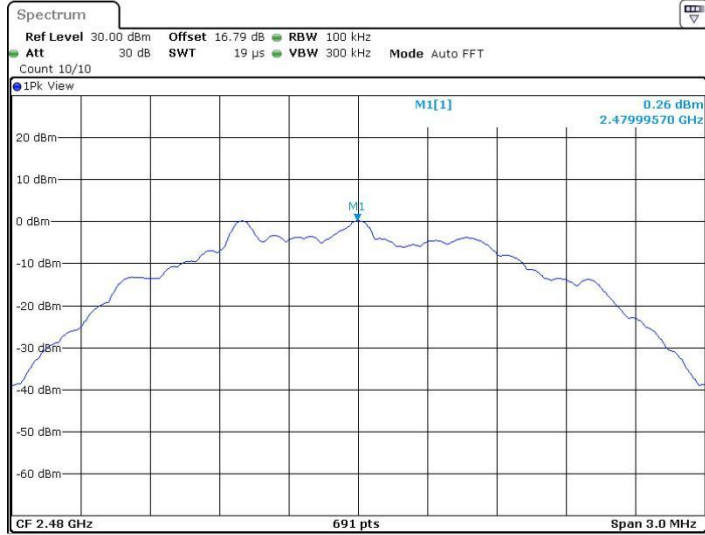

Date: 28.AUG.2024 18:53:17

BLE_2M_Ant1_2480_30~1000

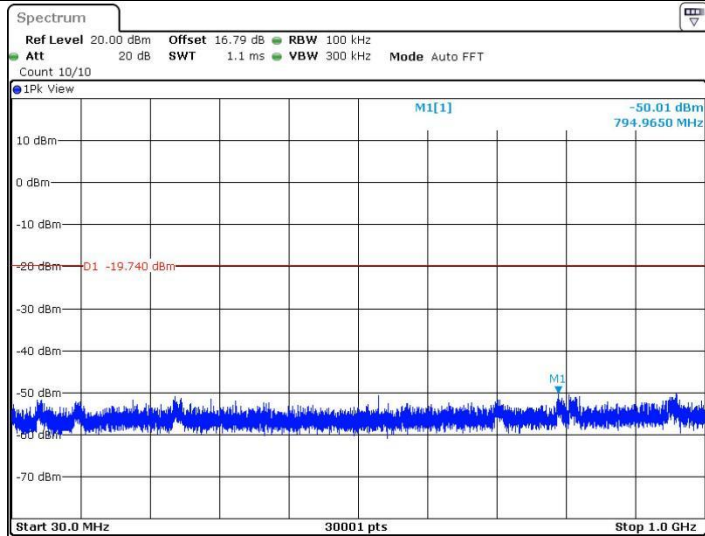

Date: 28.AUG.2024 18:53:24

BLE_2M_Ant1_2480_1000~26500

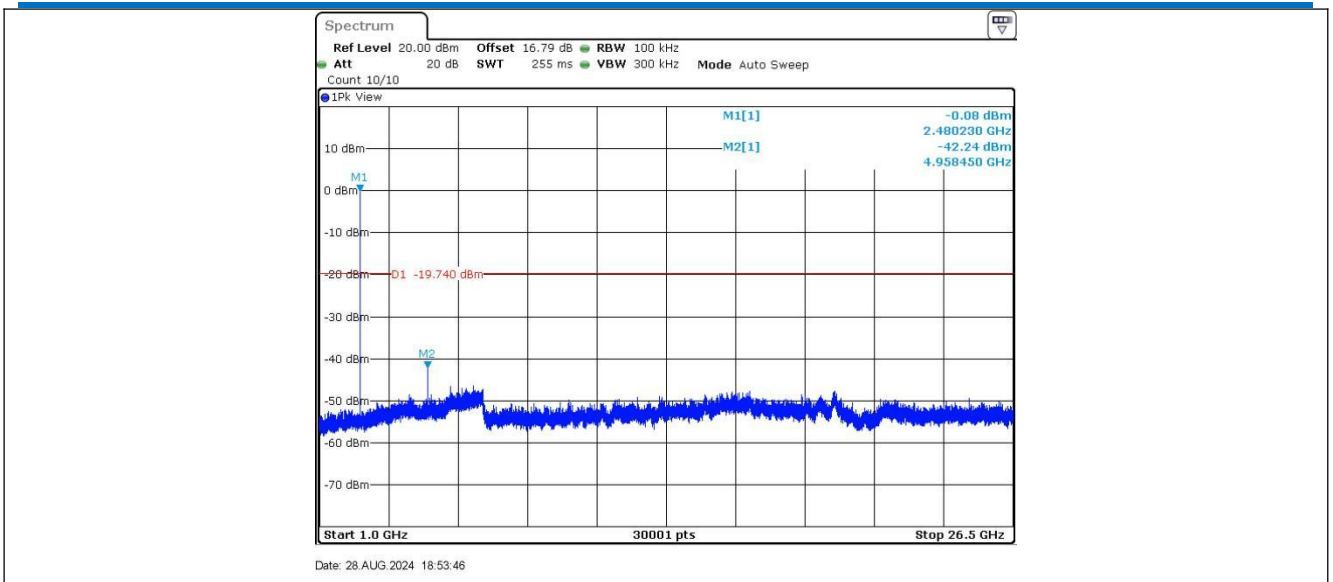

Remark:

Pretest 9kHz to 25GHz, find the highest point when testing, so only the worst data were shown in the test report. Per FCC Part 15.33 (a) and 15.31 (o), The amplitude of spurious emissions from intentional radiators which are attenuated more than 20 dB below the permissible value need not be reported unless specifically required elsewhere in this part.

5.8 Radiated Spurious Emission & Restricted bands

5.8.1 Spurious Emissions					
Test Requirement:	47 CFR Part 15C Section 15.209 and 15.205				
Test Method:	ANSI C63.10 2013				
Test Site:	Measurement Distance: 3m (Semi-Anechoic Chamber)				
Receiver Setup:	Frequency	Detector	RBW	VBW	Remark
	0.009MHz-0.090MHz	Peak	10kHz	30kHz	Peak
	0.009MHz-0.090MHz	Average	10kHz	30kHz	Average
	0.090MHz-0.110MHz	Quasi-peak	10kHz	30kHz	Quasi-peak
	0.110MHz-0.490MHz	Peak	10kHz	30kHz	Peak
	0.110MHz-0.490MHz	Average	10kHz	30kHz	Average
	0.490MHz -30MHz	Quasi-peak	10kHz	30kHz	Quasi-peak
	30MHz-1GHz	Quasi-peak	100 kHz	300kHz	Quasi-peak
	Above 1GHz	Peak	1MHz	3MHz	Peak
Peak		1MHz	10Hz	Average	
Limit:	Frequency	Field strength (microvolt/meter)	Limit (dBuV/m)	Remark	Measurement distance (m)
	0.009MHz-0.490MHz	2400/F(kHz)	-	-	300
	0.490MHz-1.705MHz	24000/F(kHz)	-	-	30
	1.705MHz-30MHz	30	-	-	30
	30MHz-88MHz	100	40.0	Quasi-peak	3
	88MHz-216MHz	150	43.5	Quasi-peak	3
	216MHz-960MHz	200	46.0	Quasi-peak	3
	960MHz-1GHz	500	54.0	Quasi-peak	3
	Above 1GHz	500	54.0	Average	3
<p>Note: 15.35(b), Unless otherwise specified, the limit on peak radio frequency emissions is 20dB above the maximum permitted average emission limit applicable to the equipment under test. This peak limit applies to the total peak emission level radiated by the device.</p>					

Test Setup:

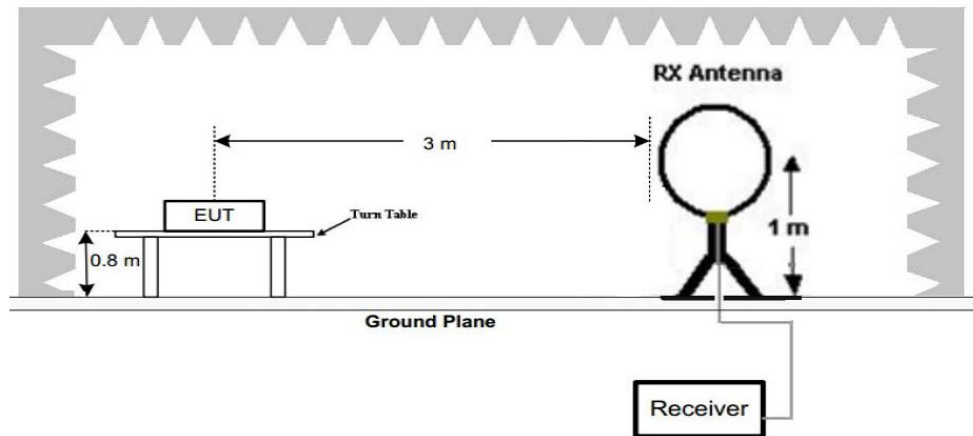

Figure 1. Below 30MHz

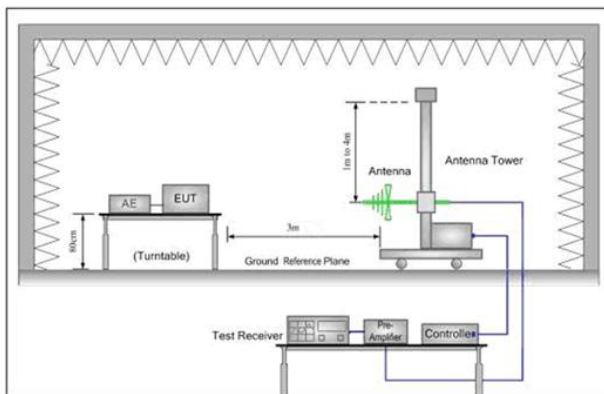

Figure 2. 30MHz to 1GHz

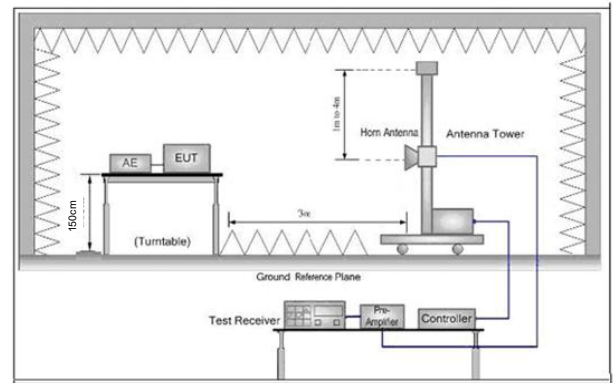

Figure 3. Above 1 GHz

Test Procedure:

- a. 1) Below 1G: The EUT was placed on the top of a rotating table 0.8 meters above the ground at a 3 meter semi-anechoic chamber. The table was rotated 360 degrees to determine the position of the highest radiation.
 2) Above 1G: The EUT was placed on the top of a rotating table 1.5 meters above the ground at a 3 meter semi-anechoic chamber. The table was rotated 360 degrees to determine the position of the highest radiation.
 Note: For the radiated emission test above 1GHz:
 Place the measurement antenna away from each area of the EUT determined to be a source of emissions at the specified measurement distance, while keeping the measurement antenna aimed at the source of emissions at each frequency of significant emissions, with polarization oriented for maximum response. The measurement antenna may have to be higher or lower than the EUT, depending on the radiation pattern of the emission and staying aimed at the emission source for receiving the maximum signal. The final measurement antenna elevation shall be that which maximizes the emissions. The measurement antenna elevation for maximum emissions shall be restricted to a range of heights of from 1 m to 4 m above the ground or reference ground plane.
- b. The EUT was set 3 meters away from the interference-receiving antenna, which was mounted on the top of a variable-height antenna tower.
- c. The antenna height is varied from one meter to four meters above the ground to determine the maximum value of the field strength. Both

	<p>horizontal and vertical polarizations of the antenna are set to make the measurement.</p> <p>d. For each suspected emission, the EUT was arranged to its worst case and then the antenna was tuned to heights from 1 meter to 4 meters (for the test frequency of below 30MHz, the antenna was tuned to heights 1 meter) and the rotatable table was turned from 0 degrees to 360 degrees to find the maximum reading.</p> <p>e. The test-receiver system was set to Peak Detect Function and Specified Bandwidth with Maximum Hold Mode.</p> <p>f. If the emission level of the EUT in peak mode was 10dB lower than the limit specified, then testing could be stopped and the peak values of the EUT would be reported. Otherwise the emissions that did not have 10dB margin would be re-tested one by one using peak, quasi-peak or average method as specified and then reported in a data sheet.</p> <p>g. Test the EUT in the lowest channel (2402MHz),the middle channel (2440MHz),the Highest channel (2480MHz)</p> <p>h. The radiation measurements are performed in X, Y, Z axis positioning for Transmitting mode, and found the X axis positioning which it is the worst case.</p> <p>i. Repeat above procedures until all frequencies measured was complete.</p>
Exploratory Test Mode:	Transmitting with GFSK modulation. Transmitting mode.
Final Test Mode:	Through Pre-scan, find the 1Mbps of data type and GFSK modulation is the worst case. For below 1GHz part, through pre-scan, the worst case is the highest channel. Only the worst case is recorded in the report.
Test Results:	Pass

Radiated Emission below 1GHz

30MHz~1GHz, the worst case

Test mode: Transmitting mode Horizontal

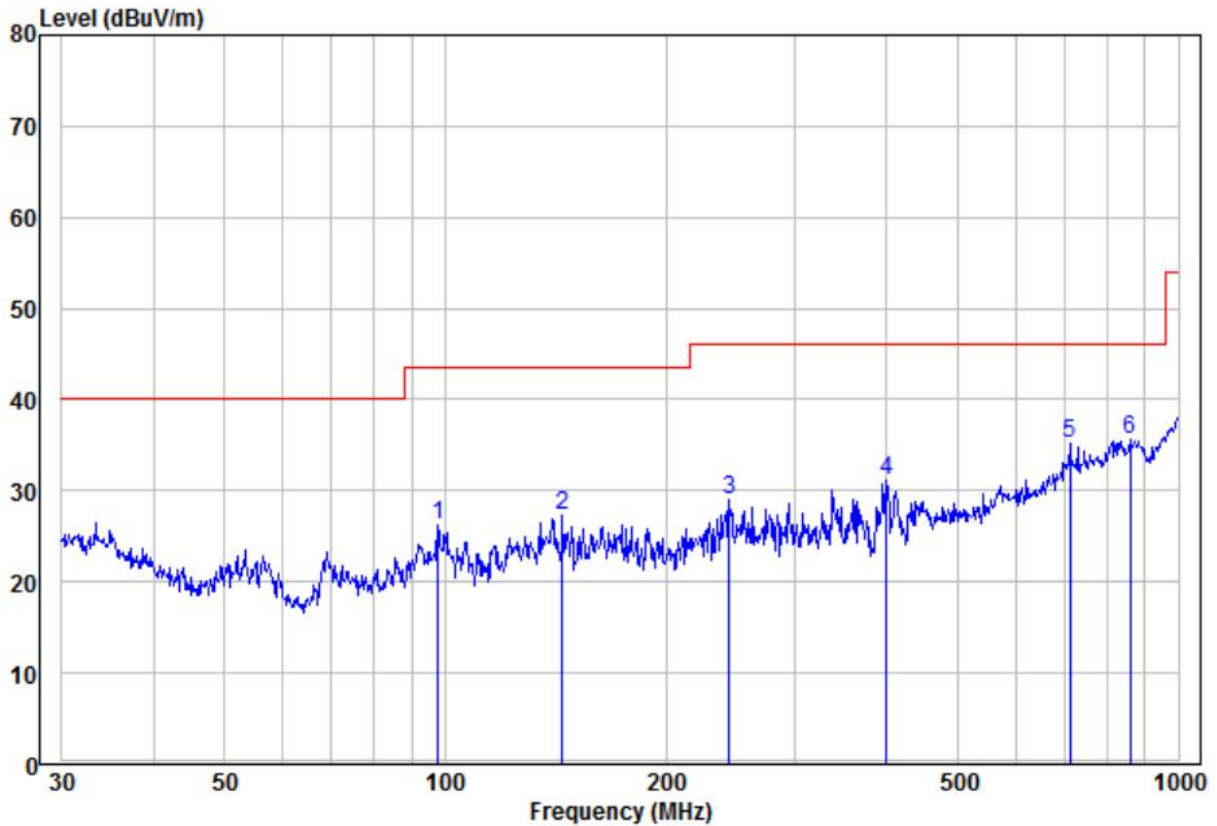

	Read Freq	Read Level	Factor	Limit Level	Over Limit	Remark	Pol/Phase	APos	TPos
	MHz	dBuV	dB/m	dBuV/m	dBuV/m	dB		cm	deg
1	97.80	14.70	11.59	26.29	43.50	-17.21	Peak	---	360
2	144.33	17.81	9.52	27.33	43.50	-16.17	Peak	---	360
3	244.23	15.56	13.40	28.96	46.00	-17.04	Peak	---	360
4	400.43	14.36	16.88	31.24	46.00	-14.76	Peak	---	360
5	711.67	11.66	23.47	35.13	46.00	-10.87	Peak	---	360
6 pp	860.04	8.73	26.80	35.53	46.00	-10.47	Peak	---	360

30MHz~1GHz, the worst case		
Test mode:	Transmitting mode	Vertical

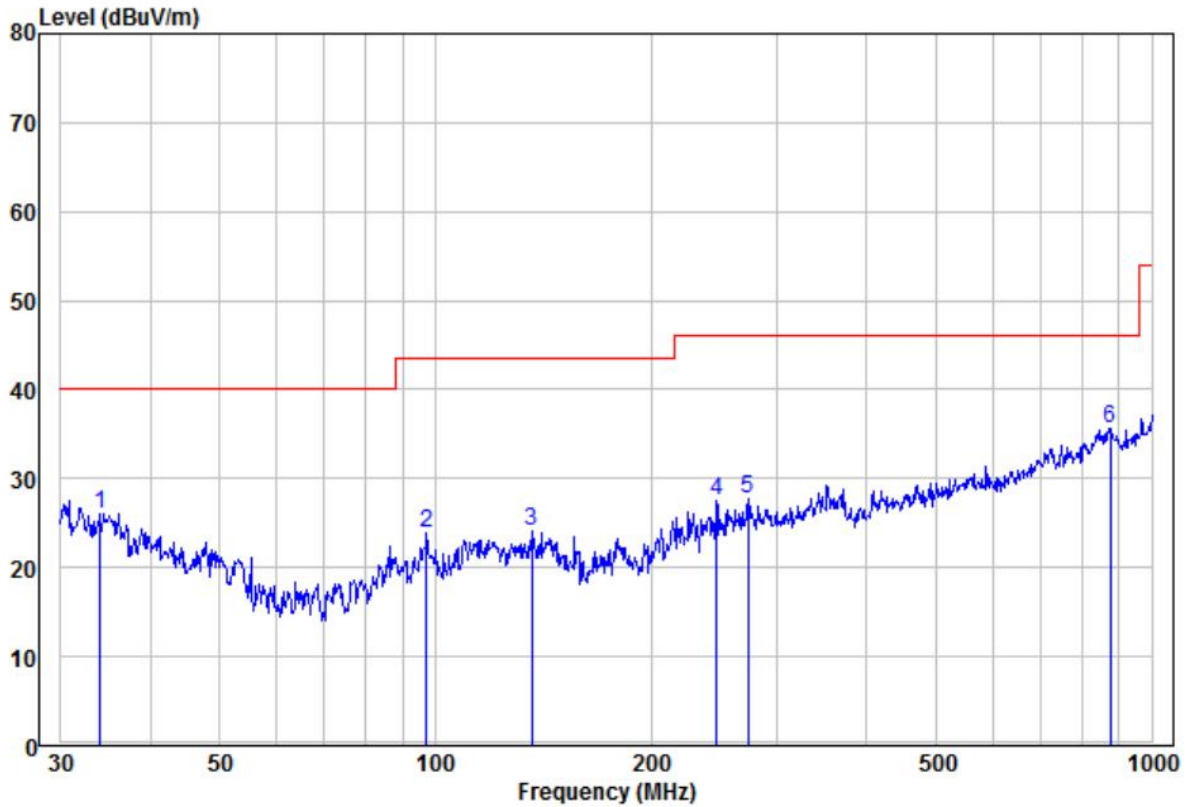

	Read Freq	Read Level	Factor	Limit Level	Over Limit	Remark	Pol/Phase	APos	TPos
	MHz	dBuV	dB/m	dBuV/m	dBuV/m	dB		cm	deg
1	34.04	10.84	15.23	26.07	40.00	-13.93	Peak	---	0
2	97.11	12.37	11.54	23.91	43.50	-19.59	Peak	---	0
3	136.46	14.00	10.11	24.11	43.50	-19.39	Peak	---	0
4	246.81	14.03	13.52	27.55	46.00	-18.45	Peak	---	0
5	273.23	13.36	14.41	27.77	46.00	-18.23	Peak	---	0
6 pp	875.25	8.90	26.77	35.67	46.00	-10.33	Peak	---	0

Transmitter Emission above 1GHz

Worse case mode:		GFSK(1Mbps)		Test channel:		Lowest	
Frequency	Meter Reading	Factor	Emission Level	Limits	Over	Detector Type	Ant. Pol.
(MHz)	(dB μ V)	(dB)	(dB μ V/m)	(dB μ V/m)	(dB)		H/V
2390	54.04	-9.2	44.84	74	-29.16	Peak	H
2400	55.24	-9.39	45.85	74	-28.15	Peak	H
4804	53.01	-4.33	48.68	74	-25.32	Peak	H
7206	51.03	1.01	52.04	74	-21.96	Peak	H
2390	56.14	-9.2	46.94	74	-27.06	Peak	V
2400	55.41	-9.39	46.02	74	-27.98	Peak	V
4804	54.16	-4.33	49.83	74	-24.17	Peak	V
7206	48.72	1.01	49.73	74	-24.27	Peak	V

Worse case mode:		GFSK(1Mbps)		Test channel:		Middle	
Frequency	Meter Reading	Factor	Emission Level	Limits	Over	Detector Type	Ant. Pol.
(MHz)	(dB μ V)	(dB)	(dB μ V/m)	(dB μ V/m)	(dB)		H/V
4880	52.99	-4.11	48.88	74	-25.12	peak	H
7320	49.34	1.51	50.85	74	-23.15	peak	H
4880	51.84	-4.11	47.73	74	-26.27	peak	V
7320	50.03	1.51	51.54	74	-22.46	peak	V

Worse case mode:		GFSK(1Mbps)		Test channel:		Highest	
Frequency	Meter Reading	Factor	Emission Level	Limits	Over	Detector Type	Ant. Pol.
(MHz)	(dB μ V)	(dB)	(dB μ V/m)	(dB μ V/m)	(dB)		H/V
2483.5	54.40	-9.29	45.11	74	-28.89	Peak	H
4960	50.79	-4.04	46.75	74	-27.25	Peak	H
7440	48.90	1.57	50.47	74	-23.53	Peak	H
2483.5	53.75	-9.29	44.46	74	-29.54	Peak	V
4960	50.58	-4.04	46.54	74	-27.46	Peak	V
7440	50.40	1.57	51.97	74	-22.03	Peak	V

Worse case mode:		GFSK(2Mbps)		Test channel:		Lowest	
Frequency	Meter Reading	Factor	Emission Level	Limits	Over	Detector Type	Ant. Pol.
(MHz)	(dBμV)	(dB)	(dBμV/m)	(dBμV/m)	(dB)		H/V
2390	53.94	-9.2	44.74	74	-29.26	Peak	H
2400	54.32	-9.39	44.93	74	-29.07	Peak	H
4804	54.04	-4.33	49.71	74	-24.29	Peak	H
7206	50.90	1.01	51.91	74	-22.09	Peak	H
2390	54.06	-9.2	44.86	74	-29.14	Peak	V
2400	54.76	-9.39	45.37	74	-28.63	Peak	V
4804	53.40	-4.33	49.07	74	-24.93	Peak	V
7206	51.14	1.01	52.15	74	-21.85	Peak	V

Worse case mode:		GFSK(2Mbps)		Test channel:		Middle	
Frequency	Meter Reading	Factor	Emission Level	Limits	Over	Detector Type	Ant. Pol.
(MHz)	(dBμV)	(dB)	(dBμV/m)	(dBμV/m)	(dB)		H/V
4880	51.79	-4.11	47.68	74	-26.32	peak	H
7320	49.02	1.51	50.53	74	-23.47	peak	H
4880	53.60	-4.11	49.49	74	-24.51	peak	V
7320	48.75	1.51	50.26	74	-23.74	peak	V

Worse case mode:		GFSK(2Mbps)		Test channel:		Highest	
Frequency	Meter Reading	Factor	Emission Level	Limits	Over	Detector Type	Ant. Pol.
(MHz)	(dBμV)	(dB)	(dBμV/m)	(dBμV/m)	(dB)		H/V
2483.5	54.51	-9.29	45.22	74	-28.78	Peak	H
4960	51.69	-4.04	47.65	74	-26.35	Peak	H
7440	48.89	1.57	50.46	74	-23.54	Peak	H
2483.5	55.09	-9.29	45.80	74	-28.20	Peak	V
4960	51.17	-4.04	47.13	74	-26.87	Peak	V
7440	48.82	1.57	50.39	74	-23.61	Peak	V

Remark:

- The field strength is calculated by adding the Antenna Factor, Cable Factor & Preamplifier. The basic equation with a sample calculation is as follows:
Final Test Level = Receiver Reading + Antenna Factor + Cable Factor – Preamplifier Factor
- Scan from 9kHz to 25GHz, the disturbance above 10GHz and below 30MHz was very low. As shown in this section, for frequencies above 1GHz, the field strength limits are based on average limits. However, the peak field strength of any emission shall not exceed the maximum permitted average limits specified above by more than 20 dB under any condition of modulation. So, only the peak measurements were shown in the report.

6 Photographs - EUT Test Setup

6.1 Radiated Emission

9KHz~30MHz:



30MHz~1GHz:



Above 1GHz:



6.2 Conducted Emission

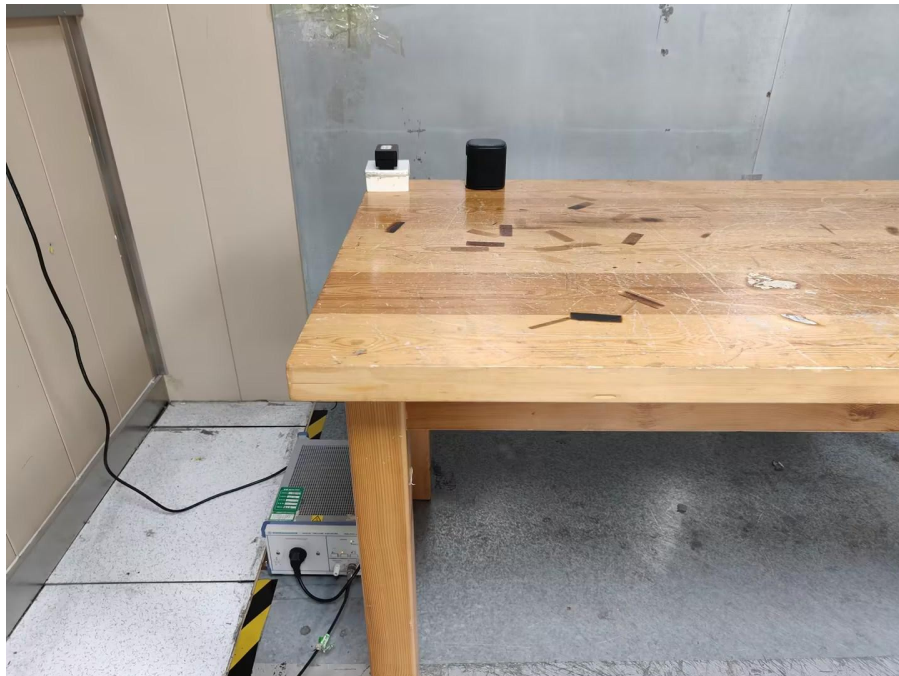

7 Photographs - EUT Constructional Details

