

FCC PART 15C
Measurement and Test Report
For
Ultimea Technology (Shenzhen) Limited

FCC ID:2A900-U0340P

FCC Rule(s)/Methods:	FCC CFR Title 47 Part 15 Subpart C Section 15.247 ANSI C63.10:2013
Product Description:	Poseidon E40 Smart Projector
Trademark	ULTIMEA
Model/Type reference.:	U0340
Report No.:	BSL2401318275087F
Date of receipt of test item :	Jan. 23, 2024
Date of sampling :	Jan. 23, 2024
Tested Date:	Jan. 23, 2024 to Jan. 31, 2024
Issued Date:	Jan. 31, 2024
Tested By:	Lris Yao/ Engineer <i>Lris Yao</i>
Reviewed By:	Levi Xiao/ EMC Manager <i>Levi Xiao</i>
Approved & Authorized By:	Salon Ouyang / PSQ Manager <i>Salon ouyang.</i>
BSL Testing Co.,LTD.	
1/F, Building B, Xinshidai GR Park, Shiyuan Street, Bao'an District, Shenzhen, Shiyuan Street, Bao'an District, Shenzhen, Guangdong, 518052, People' s Republic of China	
Tel: 400-882-9628	Fax: 86- 755-26508703

Table of Contents	Page
1.VERSION	4
2. SUMMARY OF TEST RESULTS	5
2.1 TEST FACILITY	6
2.2 MEASUREMENT UNCERTAINTY	6
3. GENERAL INFORMATION	7
3.1 GENERAL DESCRIPTION	7
3.2 DESCRIPTION OF TEST MODES	9
3.3 BLOCK DIGRAM SHOWING THE CONFIGURATION OF SYSTEM TESTED	9
3.4 DESCRIPTION OF SUPPORT UNITS(CONDUCTED MODE)	9
3.5 EQUIPMENTS LIST FOR ALL TEST ITEMS	10
4. EMC EMISSION TEST	12
4.1 CONDUCTED EMISSION MEASUREMENT	12
4.1.1 POWER LINE CONDUCTED EMISSION Limits	12
4.1.2 TEST PROCEDURE	12
4.1.3 DEVIATION FROM TEST STANDARD	12
4.1.4 TEST SETUP	13
4.1.5 EUT OPERATING CONDITIONS	13
4.2 RADIATED EMISSION LIMITS	16
4.2.1 RADIATED EMISSION LIMITS	16
4.2.2 TEST PROCEDURE	17
4.2.3 DEVIATION FROM TEST STANDARD	17
4.2.4 TEST SETUP	17
4.2.5 EUT OPERATING CONDITIONS	18
5.RADIATED BAND EMISSION MEASUREMENT	23
5.1 TEST REQUIREMENT:	23
5.2 TEST PROCEDURE	23
5.3 DEVIATION FROM TEST STANDARD	23
5.4 TEST SETUP	24
5.5 EUT OPERATING CONDITIONS	24
5.6 TEST RESULT	25
6.POWER SPECTRAL DENSITY TEST	26
6.1 APPLIED PROCEDURES / LIMIT	26
6.2 TEST PROCEDURE	26
6.3 DEVIATION FROM STANDARD	26
6.4 TEST SETUP	26
6.5 EUT OPERATION CONDITIONS	26
6.6 TEST RESULT	27

Table of Contents	Page
7. CHANNEL BANDWIDTH	29
7.1 APPLIED PROCEDURES / LIMIT	29
7.2 TEST PROCEDURE	29
7.3 DEVIATION FROM STANDARD	29
7.4 TEST SETUP	29
7.5 EUT OPERATION CONDITIONS	29
7.6 TEST RESULT	30
8. PEAK OUTPUT POWER TEST	32
8.1 APPLIED PROCEDURES / LIMIT	32
8.2 TEST PROCEDURE	32
8.3 DEVIATION FROM STANDARD	32
8.4 TEST SETUP	32
8.5 EUT OPERATION CONDITIONS	32
8.6 TEST RESULT	33
9. CONDUCTED BAND EDGE AND SPURIOUS EMISSION	34
9.1 APPLICABLE STANDARD	34
9.2 TEST PROCEDURE	34
9.3 DEVIATION FROM STANDARD	34
9.4 TEST SETUP	34
9.5 EUT OPERATION CONDITIONS	34
10. ANTENNA REQUIREMENT	40
11. TEST SETUP PHOTO	41
12. EUT CONSTRUCTIONAL DETAILS	41

1.VERSION

Report No.	Version	Description	Approved
BSL2401318275087F	Rev.01	Initial issue of report	Jan. 31, 2024

2. SUMMARY OF TEST RESULTS

Test procedures according to the technical standards:

FCC Part15 (15.247) , Subpart C			
Standard Section	Test Item	Judgment	Remark
FCC part 15.203/15.247 (c)	Antenna requirement	PASS	
FCC part 15.207	AC Power Line Conducted Emission	PASS	
FCC part 15.247 (b)(3)	Conducted Peak Output Power	PASS	
FCC part 15.247 (a)(2)	Channel Bandwidth	PASS	
FCC part 15.247 (e)	Power Spectral Density	PASS	
FCC part 15.247(d)	Conducted Band Edge and Spurious Emission	PASS	
FCC part 15.205/15.209	Spurious Emission	PASS	

NOTE:

(1)"N/A" denotes test is not applicable in this Test Report

2.1 TEST FACILITY

BSL TESTING CO., LTD

Add. : 1/F, Building B, Xinshidai GR Park, Shiyan Street, Bao'an District, Shenzhen, Shiyan Street, Bao'an District, Shenzhen, Guangdong, 518052, People's Republic of China

FCC Test Firm Registration Number: 562200

Designation Number: CN1338

IC Registered No.: 11093A

Designation Number: CN0019

2.2 MEASUREMENT UNCERTAINTY

The reported uncertainty of measurement $y \pm U$ · where expanded uncertainty U is based on a standard uncertainty multiplied by a coverage factor of $k=2$ · providing a level of confidence of approximately 95 % .

No.	Item	Uncertainty
1	3m chamber Radiated spurious emission(9KHz-30MHz)	U=4.5dB
2	3m chamber Radiated spurious emission(30MHz-1GHz)	U=4.8dB
3	3m chamber Radiated spurious emission(1GHz-6GHz)	U=4.9dB
4	3m chamber Radiated spurious emission(6GHz-40GHz)	U=5.0dB
5	Conducted disturbance	U=3.2dB
6	RF Band Edge	U=1.68dB
7	RF power conducted	U=1.86dB
8	RF conducted Spurious Emission	U=2.2dB
9	RF Occupied Bandwidth	U=1.8dB
10	RF Power Spectral Density	U=1.75dB
11	humidity uncertainty	U=5.3%
12	Temperature uncertainty	U=0.59°C

3. GENERAL INFORMATION

3.1 GENERAL DESCRIPTION

Applicant:	Ultimea Technology (Shenzhen) Limited
Address of applicant:	20th Floor, Building 4, Tianan Cloud Park, Bantian St., Longgang District, Shenzhen, China
Manufacturer:	Ultimea Technology (Shenzhen) Limited
Address of manufacturer:	20th Floor, Building 4, Tianan Cloud Park, Bantian St., Longgang District, Shenzhen, China
Factory:	CRE Electronic Technology Co.,limited
Address of manufacturer:	Building 9#, 5G Intelligent Terminal Industrial Park, Wangcheng District, Changsha,Hunan, China
Product Name:	Poseidon E40 Smart Projector
Model No.:	U0340
Model Different.:	N/A
Serial No.:	N/A
Software version number:	V1.0
Hardware version number:	V1.0
Sample(s) Status:	Engineer sample
Operation Frequency:	2402MHz~2480MHz
Channel Numbers:	40
Channel Separation:	2MHz
Modulation Type:	GFSK
Antenna Type:	Internal antenna
Antenna gain:	3.53dBi
Power supply:	DC 24V, 8.33A, 200W from ADAPTER
SWITCHING POWER ADAPTER:	Model No.:GQ180-2400833-E1 Input:AC 100-240V, 50/60Hz, 2.5A Max Output:DC 24, 8.33A, 200W

Operation Frequency each of channel							
Channel	Frequency	Channel	Frequency	Channel	Frequency	Channel	Frequency
1	2402 MHz	11	2422 MHz	21	2442 MHz	31	2462 MHz
2	2404 MHz	12	2424 MHz	22	2444 MHz	32	2464 MHz
3	2406 MHz	13	2426 MHz	23	2446 MHz	33	2466 MHz
4	2408 MHz	14	2428 MHz	24	2448 MHz	34	2468 MHz
5	2410 MHz	15	2430 MHz	25	2450 MHz	35	2470 MHz
6	2412 MHz	16	2432 MHz	26	2452 MHz	36	2472 MHz
7	2414 MHz	17	2434 MHz	27	2454 MHz	37	2474 MHz
8	2416 MHz	18	2436 MHz	28	2456 MHz	38	2476 MHz
9	2418 MHz	19	2438 MHz	29	2458 MHz	39	2478 MHz
10	2420 MHz	20	2440 MHz	30	2460 MHz	40	2480 MHz

Note:

In section 15.31(m), regards to the operating frequency range over 10 MHz, the Lowest frequency, the middle frequency, and the highest frequency of channel were selected to perform the test, and the selected channel see below:

Channel	Frequency
The lowest channel	2402MHz
The middle channel	2440MHz
The Highest channel	2480MHz

3.2 DESCRIPTION OF TEST MODES

Transmitting mode	Keep the EUT in continuously transmitting mode
Remark: During the test, the test voltage was tuned from 85% to 115% of the nominal rated supply voltage, and found that the worst case was under the nominal rated supply condition. So the report just shows that condition's data.	

Test Software	BLE Test Tool
Power level setup	<0dBm

3.3 BLOCK DIGRAM SHOWING THE CONFIGURATION OF SYSTEM TESTED

Conducted Emission

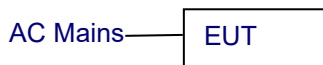

Radiated Emission

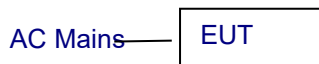

Conducted Spurious

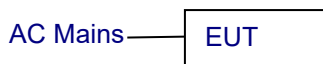

3.4 DESCRIPTION OF SUPPORT UNITS(CONDUCTED MODE)

The EUT has been tested as an independent unit together with other necessary accessories or support units. The following support units or accessories were used to form a representative test configuration during the tests.

Item	Equipment	Mfr/Brand	Model/Type No.	Series No.	Note
/	/	/	/	/	/

Item	Shielded Type	Ferrite Core	Length	Note

Note:

- (1) The support equipment was authorized by Declaration of Confirmation.
- (2) For detachable type I/O cable should be specified the length in cm in 『Length』 column.

3.5 EQUIPMENTS LIST FOR ALL TEST ITEMS

Radiation Test equipment

Item	Equipment	Manufacturer	Type No.	Serial No.	Last calibration	Calibrated until
1	Communication Tester	Rohde & Schwarz	CMW500	100358 Fireware: 4.43 SP4	Oct. 22, 2023	Oct. 21, 2024
2	Spectrum Analyzer	KEYSIGHT	9020A	MY55370835	Oct. 22, 2023	Oct. 21, 2024
3	Test Receiver	R&S	ESCI7	US47140102 Fireware: 4.42 SP3	Oct. 22, 2023	Oct. 21, 2024
4	Signal Generator	HP	83630B	3844A01028	Oct. 22, 2023	Oct. 21, 2024
5	Signal Generator	IFR	2023A	202307/242	Oct. 22, 2023	Oct. 21, 2024
6	Amplifier	Agilent	8449B	4035A00116	Oct. 22, 2023	Oct. 21, 2024
7	Amplifier	HP	8447E	2945A02770	Oct. 22, 2023	Oct. 21, 2024
8	Broadband Antenna	SCHAFFNER	2774	2774	Feb.28,2022	Feb.27,2025
9	Biconical and log periodic antennas	ELECTRO-METRICS	EM-6917B-1	171	Feb.28,2022	Feb.27,2025
10	Horn Antenna	R&S	HF906	100253	Feb.28,2022	Feb.27,2025
11	Horn Antenna	Schwarzbeck	BBHA9170	00814	Feb.28,2022	Feb.27,2025
12	Horn Antenna	EM	EM-6961	6462	Feb.28,2022	Feb.27,2025
13	3m Semi-Anechoic Chamber	Chengyu Electron	9 (L)*6 (W)* 6 (H)	BSL086	Feb.28,2022	Feb.27,2025
14	Loop Antenna	ZHINAN	ZN30900C	20073	Feb.28,2022	Feb.27,2025
15	power meter	DARE	RPR3006W	15I00041SNO0	Oct.27,2023	Oct.26,2024
16	RF Control Unit	MWRFtest	Mw100	-	Oct.27,2023	Oct.26,2024
17	Test software	MWRFtest	V8310	-	-	-
18	Turntable	MF	MF-7802BS	N/A	\	\
19	Antenna tower	MF	MF-7802BS	N/A	\	\
20	Signal Generator	Agilent	N5182A	N/A	Oct.27,2023	Oct.26,2024

Conduction Test equipment

Item	Kind of Equipment	Manufacturer	Type No.	Serial No.	Last calibration	Calibrated until
1	LISN	R&S	ENV216	101471	Oct.27,2023	Oct.26,2024
2	LISN	CYBERTEK	EM5040A	E1850400149	Oct.27,2023	Oct.26,2024
3	Test Cable	N/A	C01	N/A	Oct.27,2023	Oct.26,2024
4	Test Cable	N/A	C02	N/A	Oct.27,2023	Oct.26,2024
5	EMI Test Receiver	R&S	ESCI3	101393	Oct.27,2023	Oct.26,2024
6	Absorbing Clamp	DZ	ZN23201	15034	Oct.27,2023	Oct.26,2024

7	EMC Software	Frad	EZ-EMC	Ver.EMC-CON 3A1.1	\	\
---	--------------	------	--------	----------------------	---	---

RF Conduction Test equipment

Item	Kind of Equipment	Manufacturer	Type No.	Serial No.	Last calibration	Calibrated until
1	Spectrum Analyzer (9kHz-26.5GHz)	KEYSIGHT	9020A	MY55370835	Oct.27,2023	Oct.26,2024
2	MWRF Power Meter Test system	MW	MW100-RPCB	N/A	Oct.27,2023	Oct.26,2024
3	D.C. Power Supply	LongWei	TPR-6405D	N/A	\	\
4	RF Software	MW	MTS8310	V2.0.0.0	\	\

4. EMC EMISSION TEST

4.1 CONDUCTED EMISSION MEASUREMENT

Test Requirement:	FCC Part15 C Section 15.207
Test Method:	ANSI C63.10:2013
Test Frequency Range:	150KHz to 30MHz
Receiver setup:	RBW=9KHz, VBW=30KHz, Sweep time=auto

4.1.1 POWER LINE CONDUCTED EMISSION Limits

FREQUENCY (MHz)	Limit (dBuV)		Standard
	Quas-peak	Average	
0.15 -0.5	66 - 56 *	56 - 46 *	FCC
0.50 -5.0	56.00	46.00	FCC
5.0 -30.0	60.00	50.00	FCC

Note:

(1) *Decreases with the logarithm of the frequency.

4.1.2 TEST PROCEDURE

- a. The EUT was placed 0.8 meters from the horizontal ground plane with EUT being connected to the power mains through a line impedance stabilization network (LISN). All other support equipments powered from additional LISN(s). The LISN provide 50 Ohm/ 50uH of coupling impedance for the measuring instrument.
- b. Interconnecting cables that hang closer than 40 cm to the ground plane shall be folded back and forth in the center forming a bundle 30 to 40 cm long.
- c. I/O cables that are not connected to a peripheral shall be bundled in the center. The end of the cable may be terminated, if required, using the correct terminating impedance. The overall length shall not exceed 1 m.
- d. LISN at least 80 cm from nearest part of EUT chassis.
- e. For the actual test configuration, please refer to the related Item –EUT Test Photos.

4.1.3 DEVIATION FROM TEST STANDARD

No deviation

4.1.4 TEST SETUP

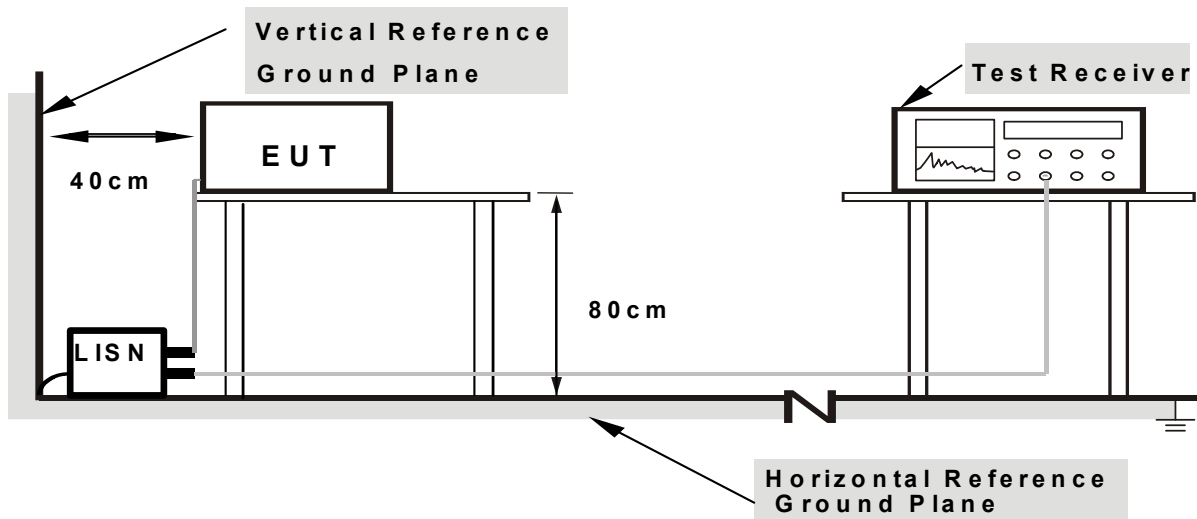

- Note: 1.Support units were connected to second LISN.**
2.Both of LISNs (AMN) are 80 cm from EUT and at least 80 cm from other units and other metal planes

4.1.5 EUT OPERATING CONDITIONS

The EUT was configured for testing in a typical fashion (as a customer would normally use it). The EUT has been programmed to Charging during test. This operating condition was tested and used to collect the included data.

We pretest AC 120V and AC 230V, the worst voltage was AC 120V and the data recording in the report.

4.1.6 Test Result PASS

4.1.6 Test Result (Worst case GFSK 2402MHz)

Temperature :	26°C	Relative Humidity:	54%
Pressure :	101kPa	Phase :	L
Test Voltage :	AC 120V/60Hz		

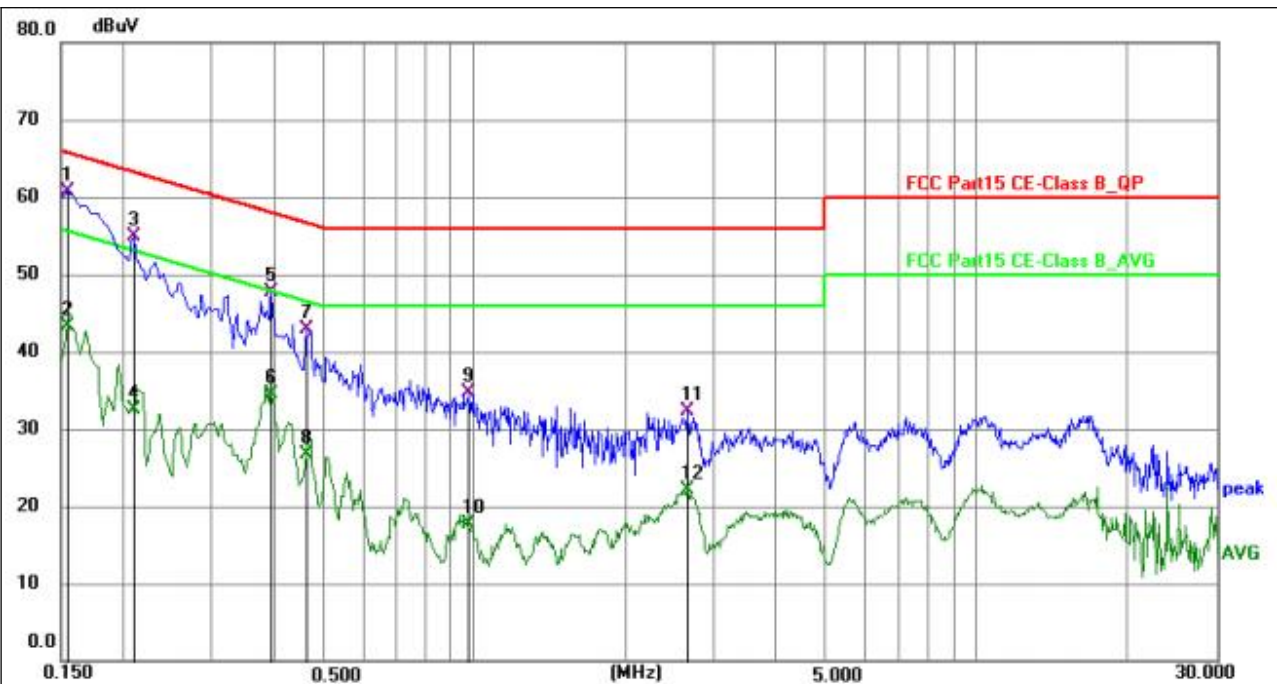

No.	Frequency (MHz)	Reading (dBuV)	Factor (dB)	Level (dBuV)	Limit (dBuV)	Margin (dB)	Detector	P/F	Remark
1 *	0.1544	51.20	9.53	60.73	65.76	-5.03	QP	P	
2	0.1544	33.72	9.53	43.25	55.76	-12.51	AVG	P	
3	0.2084	45.11	9.71	54.82	63.27	-8.45	QP	P	
4	0.2084	22.88	9.71	32.59	53.27	-20.68	AVG	P	
5	0.3930	38.10	9.65	47.75	58.00	-10.25	QP	P	
6	0.3930	24.84	9.65	34.49	48.00	-13.51	AVG	P	
7	0.4605	33.37	9.62	42.99	56.68	-13.69	QP	P	
8	0.4605	17.09	9.62	26.71	46.68	-19.97	AVG	P	
9	0.9779	25.19	9.53	34.72	56.00	-21.28	QP	P	
10	0.9779	8.11	9.53	17.64	46.00	-28.36	AVG	P	
11	2.6564	22.75	9.65	32.40	56.00	-23.60	QP	P	
12	2.6564	12.44	9.65	22.09	46.00	-23.91	AVG	P	

Notes:

- 1.An initial pre-scan was performed on the line and neutral lines with peak detector.
- 2.Quasi-Peak and Average measurement were performed at the frequencies with maximized peak emission.
- 3.Measurement Level = Reading level + Correct Factor

Temperature :	26°C	Relative Humidity:	54%
Pressure :	101kPa	Phase :	N
Test Voltage :	AC 120V/60Hz		

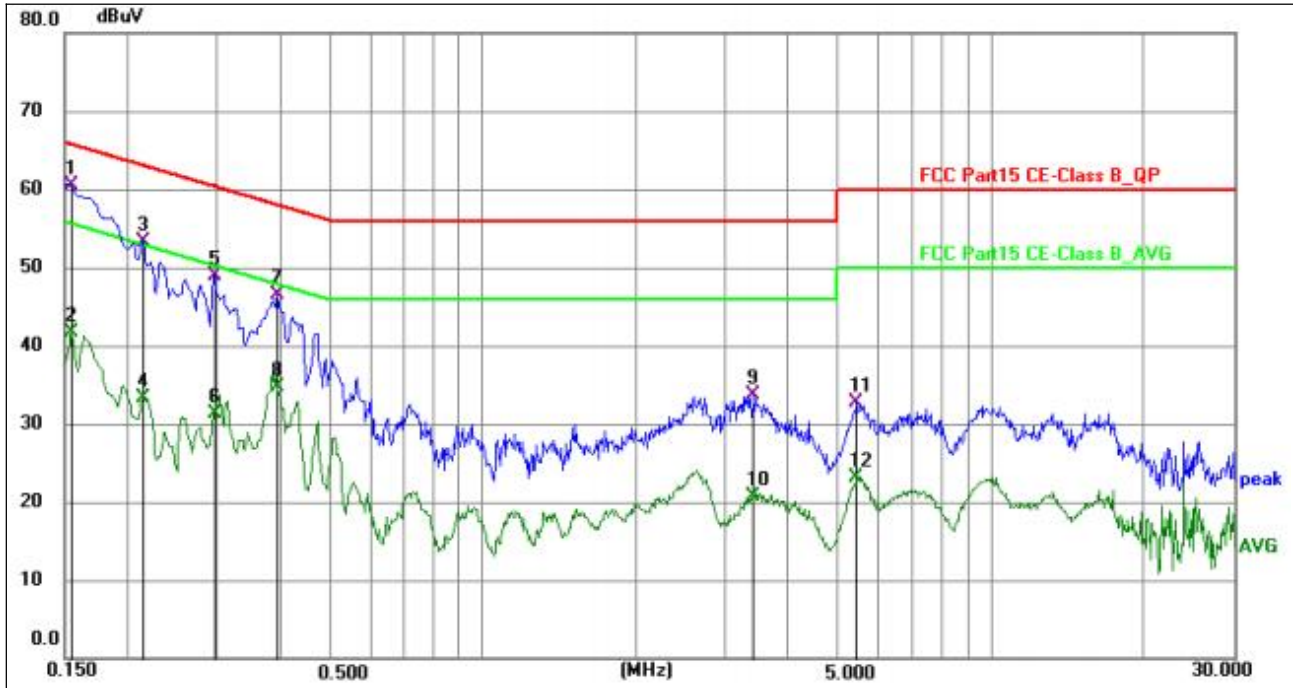

No.	Frequency (MHz)	Reading (dBuV)	Factor (dB)	Level (dBuV)	Limit (dBuV)	Margin (dB)	Detector	P/F	Remark
1 *	0.1545	50.99	9.53	60.52	65.75	-5.23	QP	P	
2	0.1545	32.24	9.53	41.77	55.75	-13.98	AVG	P	
3	0.2130	43.67	9.71	53.38	63.09	-9.71	QP	P	
4	0.2130	23.59	9.71	33.30	53.09	-19.79	AVG	P	
5	0.2940	39.15	9.68	48.83	60.41	-11.58	QP	P	
6	0.2940	21.59	9.68	31.27	50.41	-19.14	AVG	P	
7	0.3930	36.82	9.65	46.47	58.00	-11.53	QP	P	
8	0.3930	25.12	9.65	34.77	48.00	-13.23	AVG	P	
9	3.4035	24.02	9.59	33.61	56.00	-22.39	QP	P	
10	3.4035	11.11	9.59	20.70	46.00	-25.30	AVG	P	
11	5.4420	23.17	9.53	32.70	60.00	-27.30	QP	P	
12	5.4420	13.48	9.53	23.01	50.00	-26.99	AVG	P	

Notes:

1. An initial pre-scan was performed on the line and neutral lines with peak detector.
2. Quasi-Peak and Average measurement were performed at the frequencies with maximized peak emission.
3. Measurement Level = Reading level + Correct Factor

4.2 RADIATED EMISSION MEASUREMENT

Test Requirement:	FCC Part15 C Section 15.209				
Test Method:	ANSI C63.10:2013				
Test Frequency Range:	9kHz to 25GHz				
Test site:	Measurement Distance: 3m				
Receiver setup:	Frequency	Detector	RBW	VBW	Value
	9KHz-150KHz	Quasi-peak	200Hz	600Hz	Quasi-peak
	150KHz-30MHz	Quasi-peak	9KHz	30KHz	Quasi-peak
	30MHz-1GHz	Quasi-peak	100KHz	300KHz	Quasi-peak
	Above 1GHz	Peak	1MHz	3MHz	Peak
Peak		1MHz	10Hz	Average	

4.2.1 RADIATED EMISSION LIMITS

Frequencies (MHz)	Field Strength (micorvolts/meter)	Measurement Distance (meters)
0.009~0.490	2400/F(KHz)	300
0.490~1.705	24000/F(KHz)	30
1.705~30.0	30	30
30~88	100	3
88~216	150	3
216~960	200	3
Above 960	500	3

LIMITS OF RADIATED EMISSION MEASUREMENT

FREQUENCY (MHz)	Limit (dBuV/m) (at 3M)	
	PEAK	AVERAGE
Above 1000	74	54

Notes:

- (1) The limit for radiated test was performed according to FCC PART 15C.
- (2) The tighter limit applies at the band edges.
- (3) Emission level (dBuV/m)=20log Emission level (uV/m).

4.2.2 TEST PROCEDURE

- a. The measuring distance of at 3 m shall be used for measurements at frequency up to 25GHz. For frequencies above 1GHz, any suitable measuring distance may be used.
- b. The EUT was placed on the top of a rotating table 0.8 meters above the ground at a 3 meter semi-chamber test. The table was rotated 360 degrees to determine the position of the highest radiation.
- c. The height of the equipment or of the substitution antenna shall be 0.8m; above 1GHz, the height was 1.5m, the height of the test antenna shall vary between 1 m to 4 m. Both horizontal and vertical polarizations of the antenna are set to make the measurement.
- d. The initial step in collecting conducted emission data is a spectrum analyzer peak detector mode pre-scanning the measurement frequency range. Significant peaks are then marked and then Quasi Peak detector mode re-measured.
- e. If the Peak Mode measured value compliance with and lower than Quasi Peak Mode Limit, the EUT shall be deemed to meet QP Limits and then no additional QP Mode measurement performed.
- f. For the actual test configuration, please refer to the related Item –EUT Test Photos.

g. For the radiated emission test above 1GHz:

Place the measurement antenna away from each area of the EUT determined to be a source of emissions at the specified measurement distance, while keeping the measurement antenna aimed at the source of emissions at each frequency of significant emissions, with polarization oriented for maximum response.

The measurement antenna may have to be higher or lower than the EUT, depending on the radiation pattern of the emission and staying aimed at the emission source for receiving the maximum signal. The final measurement antenna elevation shall be that which maximizes the emissions. The measurement antenna elevation for maximum emissions shall be restricted to a range of heights of from 1 m to 4 m above the ground or reference ground plane.

Note:

Both horizontal and vertical antenna polarities were tested and performed pretest to three orthogonal axis. The worst case emissions were reported

4.2.3 DEVIATION FROM TEST STANDARD

No deviation

4.2.4 TEST SETUP

(A) Radiated Emission Test-Up Frequency Below 30MHz

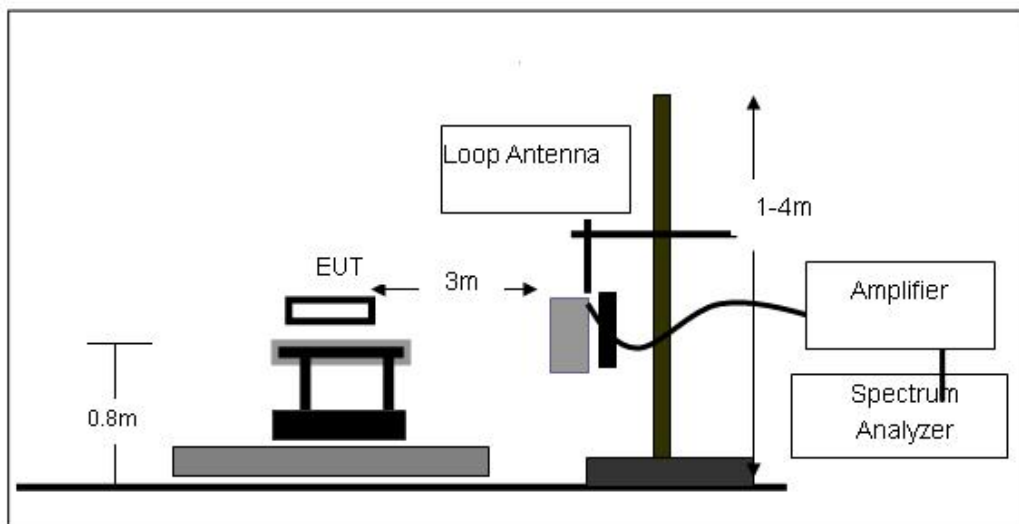

(B) Radiated Emission Test-Up Frequency 30MHz~1GHz

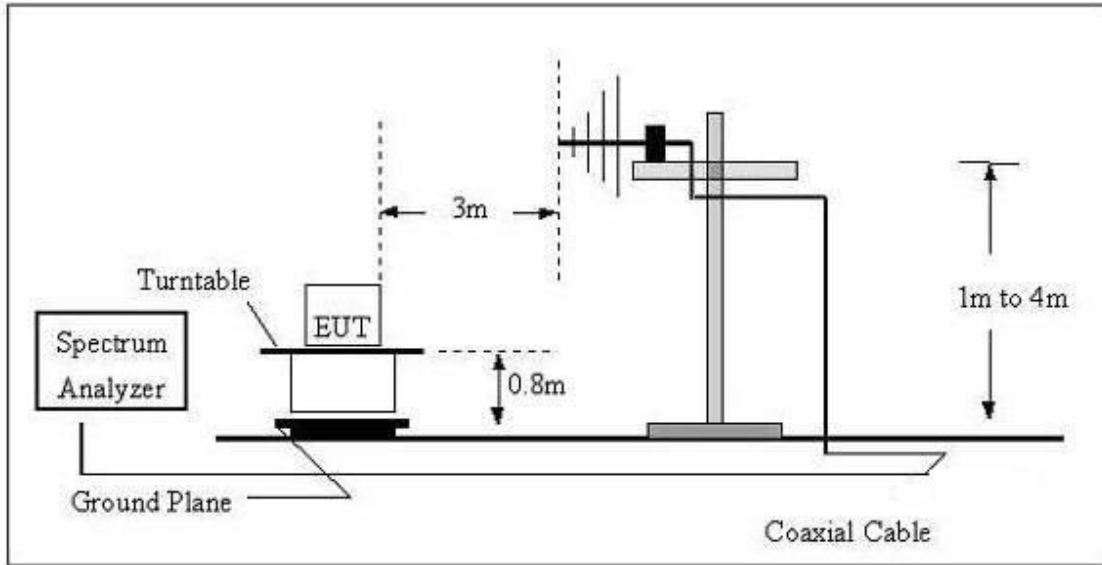

(C) Radiated Emission Test-Up Frequency Above 1GHz

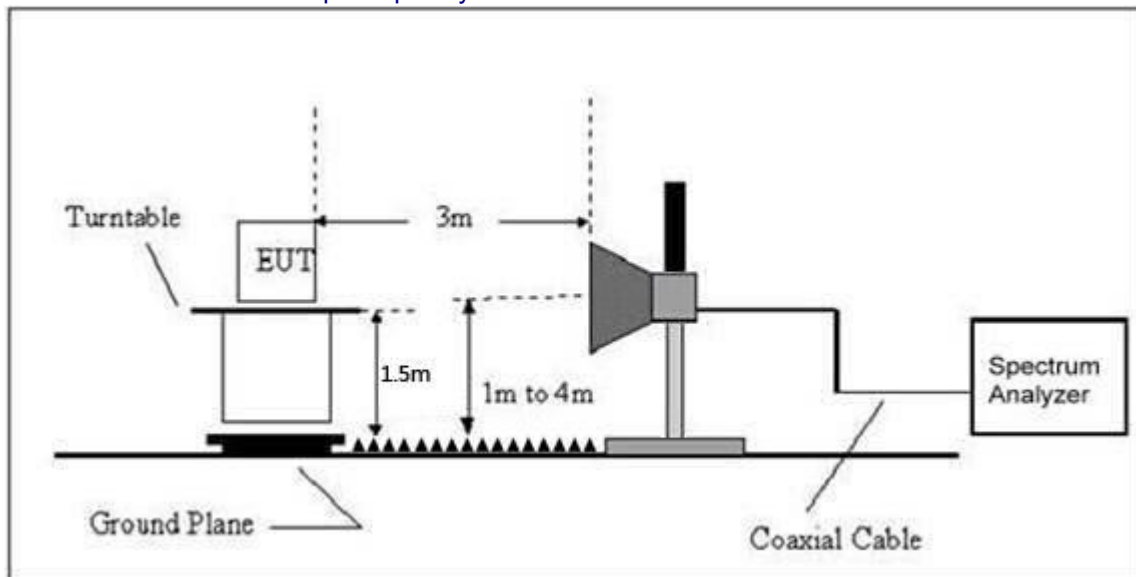

4.2.5 EUT OPERATING CONDITIONS

The EUT tested system was configured as the statements of 2.4 Unless otherwise a special operating condition is specified in the follows during the testing.

4.2.6 TEST RESULTS (Between 9KHz – 30 MHz)

The emission from 9 kHz to 30MHz was pre-tested and found the result was 20dB lower than the limit, and according to 15.31(o) & RSS-Gen 6.13, the test result no need to reported.

Between 30MHz – 1GHz (Worst case GFSK 2402MHz)

Temperature:	26°C	Relative Humidity:	54%
Pressure:	101kPa	Polarization:	Horizontal
Test Voltage:	AC 120V/60Hz		

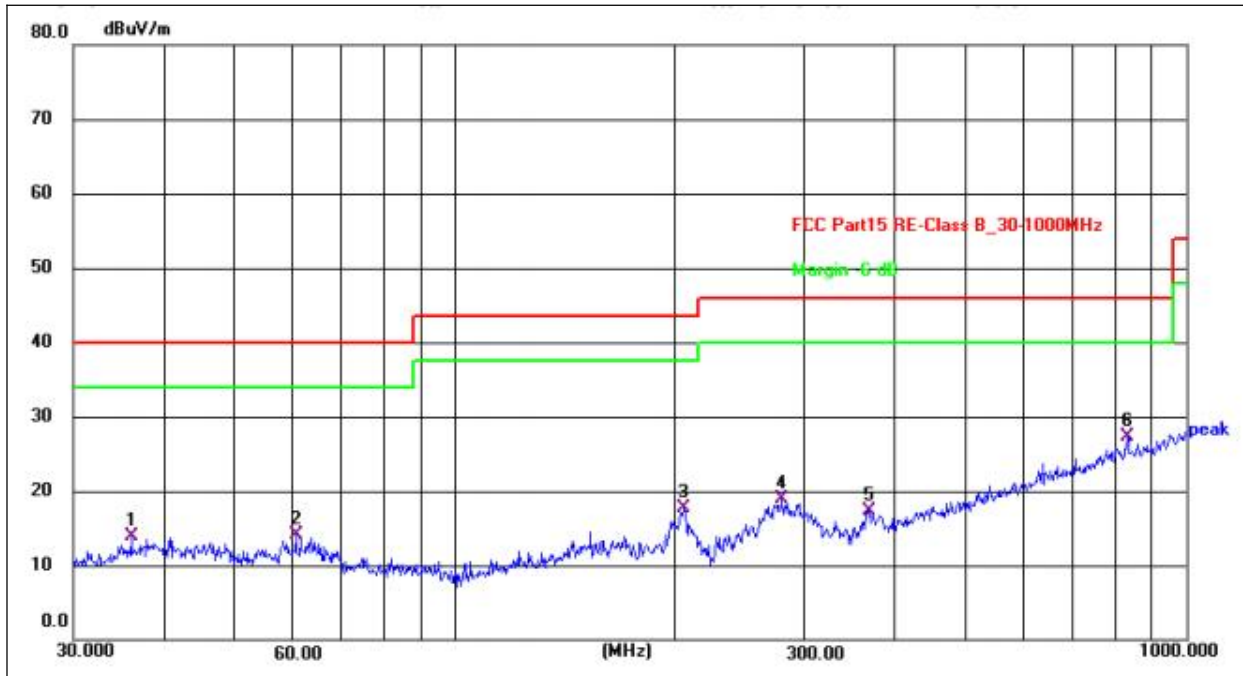

No.	Frequency (MHz)	Reading (dBuV)	Factor (dB/m)	Level (dBuV/m)	Limit (dBuV/m)	Margin (dB)	Detector
1	36.0007	30.22	-16.29	13.93	40.00	-26.07	QP
2	60.4917	31.41	-17.39	14.02	40.00	-25.98	QP
3	205.6750	36.75	-19.12	17.63	43.50	-25.87	QP
4	280.0237	35.65	-16.83	18.82	46.00	-27.18	QP
5	368.1116	31.79	-14.40	17.39	46.00	-28.61	QP
6 *	830.4000	31.56	-4.35	27.21	46.00	-18.79	QP

Temperature:	26°C	Relative Humidity:	54%
Pressure:	101kPa	Polarization:	Vertical
Test Voltage:	AC 120V/60Hz		

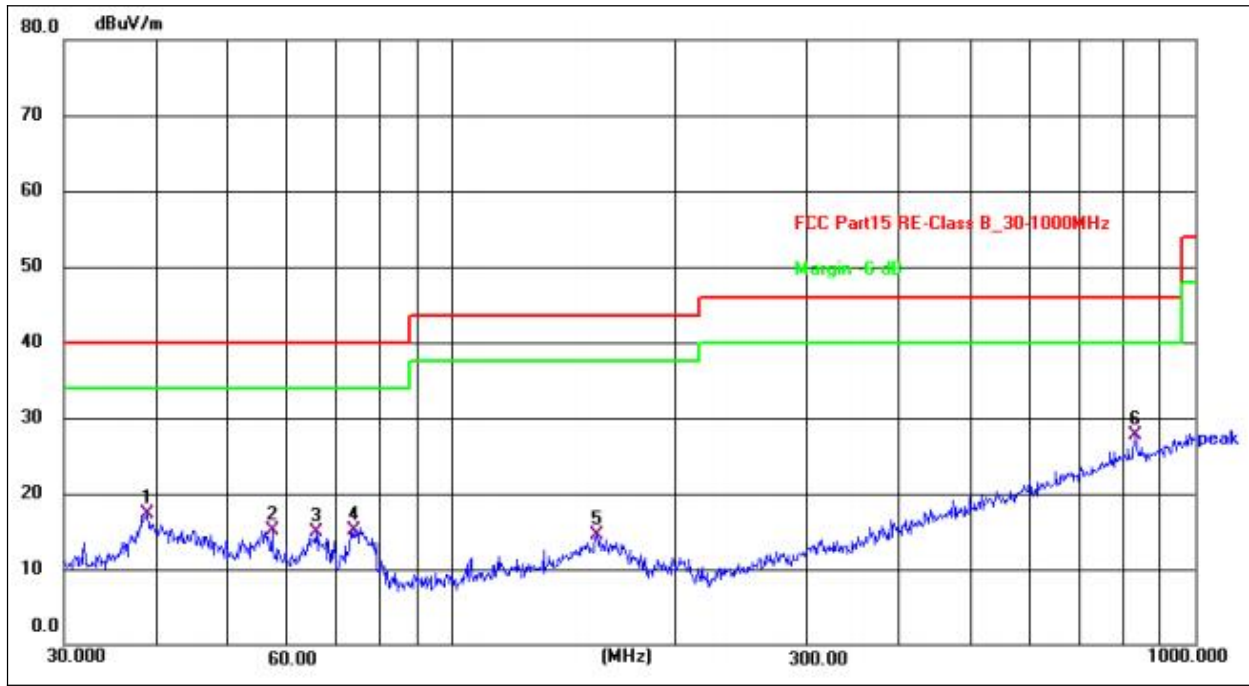

No.	Frequency (MHz)	Reading (dBuV)	Factor (dB/m)	Level (dBuV/m)	Limit (dBuV/m)	Margin (dB)	Detector
1	38.8877	33.25	-15.86	17.39	40.00	-22.61	QP
2	57.1914	32.33	-17.16	15.17	40.00	-24.83	QP
3	65.5725	32.70	-17.87	14.83	40.00	-25.17	QP
4	73.6170	34.34	-19.25	15.09	40.00	-24.91	QP
5	156.4576	30.33	-15.89	14.44	43.50	-29.06	QP
6 *	830.4000	31.97	-4.35	27.62	46.00	-18.38	QP

Remarks:

- 1.Final Level =Receiver Read level + Antenna Factor + Cable Loss – Pre-amplifier Factor
- 2.The emission levels of other frequencies are very lower than the limit and not show in test report.

1GHz~25GHz

Polar (H/V)	Frequency	Meter Reading	Pre-ampli fier	Cable Loss	Antenna Factor	Emission Level	Limits	Margin	Detector Type
	(MHz)	(dBuV)	(dB)	(dB)	(dB)	(dBuV/m)	(dBuV/m)	(dB)	
Low Channel:2402MHz									
V	4804.00	52.47	30.55	5.77	24.66	52.35	74.00	-21.65	Pk
V	4804.00	43.95	30.55	5.77	24.66	43.83	54.00	-10.17	AV
V	7206.00	52.43	30.33	6.32	24.55	52.97	74.00	-21.03	Pk
V	7206.00	43.84	30.33	6.32	24.55	44.38	54.00	-9.62	AV
V	9608.00	53.89	30.85	7.45	24.69	55.18	74.00	-18.82	Pk
V	9608.00	43.82	30.85	7.45	24.69	45.11	54.00	-8.89	AV
V	12010.00	51.27	31.02	8.99	25.57	54.81	74.00	-19.19	Pk
V	12010.00	43.51	31.02	8.99	25.57	47.05	54.00	-6.95	AV
H	4804.00	50.38	30.55	5.77	24.66	50.26	74.00	-23.74	Pk
H	4804.00	43.60	30.55	5.77	24.66	43.48	54.00	-10.52	AV
H	7206.00	50.57	30.33	6.32	24.55	51.11	74.00	-22.89	Pk
H	7206.00	43.78	30.33	6.32	24.55	44.32	54.00	-9.68	AV
H	9608.00	50.37	30.85	7.45	24.69	51.66	74.00	-22.34	Pk
H	9608.00	43.64	30.85	7.45	24.69	44.93	54.00	-9.07	AV
H	12010.00	51.47	31.02	8.99	25.57	55.01	74.00	-18.99	Pk
H	12010.00	43.35	31.02	8.99	25.57	46.89	54.00	-7.11	AV

Polar (H/V)	Frequency	Meter Reading	Pre-ampli fier	Cable Loss	Antenna Factor	Emission Level	Limits	Margin	Detector Type
	(MHz)	(dBuV)	(dB)	(dB)	(dB)	(dBuV/m)	(dBuV/m)	(dB)	
Middle Channel:2440MHz									
V	4880.00	53.40	30.55	5.77	24.66	53.28	74.00	-20.72	Pk
V	4880.00	43.43	30.55	5.77	24.66	43.31	54.00	-10.69	AV
V	7320.00	51.84	30.33	6.32	24.55	52.38	74.00	-21.62	Pk
V	7320.00	43.05	30.33	6.32	24.55	43.59	54.00	-10.41	AV
V	9760.00	51.01	30.85	7.45	24.69	52.30	74.00	-21.70	Pk
V	9760.00	43.63	30.85	7.45	24.69	44.92	54.00	-9.08	AV
V	12200.00	53.03	31.02	8.99	25.57	56.57	74.00	-17.43	Pk
V	12200.00	43.20	31.02	8.99	25.57	46.74	54.00	-7.26	AV
H	4880.00	52.85	30.55	5.77	24.66	52.73	74.00	-21.27	Pk
H	4880.00	43.07	30.55	5.77	24.66	42.95	54.00	-11.05	AV
H	7320.00	53.22	30.33	6.32	24.55	53.76	74.00	-20.24	Pk
H	7320.00	43.90	30.33	6.32	24.55	44.44	54.00	-9.56	AV
H	9760.00	50.79	30.85	7.45	24.69	52.08	74.00	-21.92	Pk
H	9760.00	43.59	30.85	7.45	24.69	44.88	54.00	-9.12	AV
H	12200.00	53.09	31.02	8.99	25.57	56.63	74.00	-17.37	Pk
H	12200.00	43.59	31.02	8.99	25.57	47.13	54.00	-6.87	AV

Polar (H/V)	Frequency	Meter Reading	Pre-ampli fier	Cable Loss	Antenna Factor	Emission Level	Limits	Margin	Detector Type
	(MHz)	(dBUV)	(dB)	(dB)	(dB)	(dBUV/m)	(dBUV/m)	(dB)	
High Channel:2480MHz									
V	4960.00	53.26	30.55	5.77	24.66	53.14	74.00	-20.86	Pk
V	4960.00	43.94	30.55	5.77	24.66	43.82	54.00	-10.18	AV
V	7440.00	52.26	30.33	6.32	24.55	52.80	74.00	-21.20	Pk
V	7440.00	43.40	30.33	6.32	24.55	43.94	54.00	-10.06	AV
V	9920.00	53.63	30.85	7.45	24.69	54.92	74.00	-19.08	Pk
V	9920.00	43.81	30.85	7.45	24.69	45.10	54.00	-8.90	AV
V	12400.00	51.87	31.02	8.99	25.57	55.41	74.00	-18.59	Pk
V	12400.00	43.09	31.02	8.99	25.57	46.63	54.00	-7.37	AV
H	4960.00	52.48	30.55	5.77	24.66	52.36	74.00	-21.64	Pk
H	4960.00	43.43	30.55	5.77	24.66	43.31	54.00	-10.69	AV
H	7440.00	54.52	30.33	6.32	24.55	55.06	74.00	-18.94	Pk
H	7440.00	43.45	30.33	6.32	24.55	43.99	54.00	-10.01	AV
H	9920.00	53.37	30.85	7.45	24.69	54.66	74.00	-19.34	Pk
H	9920.00	43.53	30.85	7.45	24.69	44.82	54.00	-9.18	AV
H	12400.00	50.90	31.02	8.99	25.57	54.44	74.00	-19.56	Pk
H	12400.00	43.87	31.02	8.99	25.57	47.41	54.00	-6.59	AV

Remark:

1. Emission Level = Meter Reading + Antenna Factor + Cable Loss – Pre-amplifier,
Margin= Emission Level - Limit
2. If peak below the average limit, the average emission was no test.
3. The amplitude of spurious emissions which are attenuated by more than 20dB below the permissible value has no need to be reported.

5.RADIATED BAND EMISSION MEASUREMENT

5.1 TEST REQUIREMENT:

Test Requirement:	FCC Part15 C Section 15.209 and 15.205				
Test Method:	ANSI C63.10: 2013				
Test Frequency Range:	All of the restrict bands were tested, only the worst band's (2310MHz to 2500MHz) data was showed.				
Test site:	Measurement Distance: 3m				
Receiver setup:	Frequency	Detector	RBW	VBW	Value
	Above 1GHz	Peak	1MHz	3MHz	Peak
		Average	1MHz	3MHz	Average

LIMITS OF RADIATED EMISSION MEASUREMENT (Above 1000MHz)

FREQUENCY (MHz)	Limit (dBuV/m) (at 3M)	
	PEAK	AVERAGE
Above 1000	74	54

Notes:

- (1) The limit for radiated test was performed according to FCC PART 15C.
- (2) The tighter limit applies at the band edges.
- (3) Emission level (dBuV/m)=20log Emission level (uV/m).

5.2 TEST PROCEDURE

Above 1GHz test procedure as below:

- a. 1. The EUT was placed on the top of a rotating table 1.5 meters above the ground at a 3 meter camber. The table was rotated 360 degrees to determine the position of the highest radiation.
- b. The EUT was set 3 meters away from the interference-receiving antenna, which was mounted on the top of a variable-height antenna tower.
- c. The antenna height is varied from one meter to four meters above the ground to determine the maximum value of the field strength. Both horizontal and vertical polarizations of the antenna are set to make the measurement.
- d. For each suspected emission, the EUT was arranged to its worst case and then the antenna was tuned to heights from 1 meter to 4 meters and the rota table was turned from 0 degrees to 360 degrees to find the maximum reading.
- e. The test-receiver system was set to Peak Detect Function and Specified Bandwidth with Maximum Hold Mode.
- f. If the emission level of the EUT in peak mode was 10dB lower than the limit specified, then testing could be stopped and the peak values of the EUT would be reported. Otherwise the emissions that did not have 10dB margin would be re-tested one by one using peak, quasi-peak or average method as specified and then reported in a data sheet.
- g. Test the EUT in the lowest channel,the Highest channel

Note:

Both horizontal and vertical antenna polarities were tested and performed pretest to three orthogonal axis. The worst case emissions were reported

5.3 DEVIATION FROM TEST STANDARD

No deviation

5.4 TEST SETUP

Radiated Emission Test-Up Frequency Above 1GHz

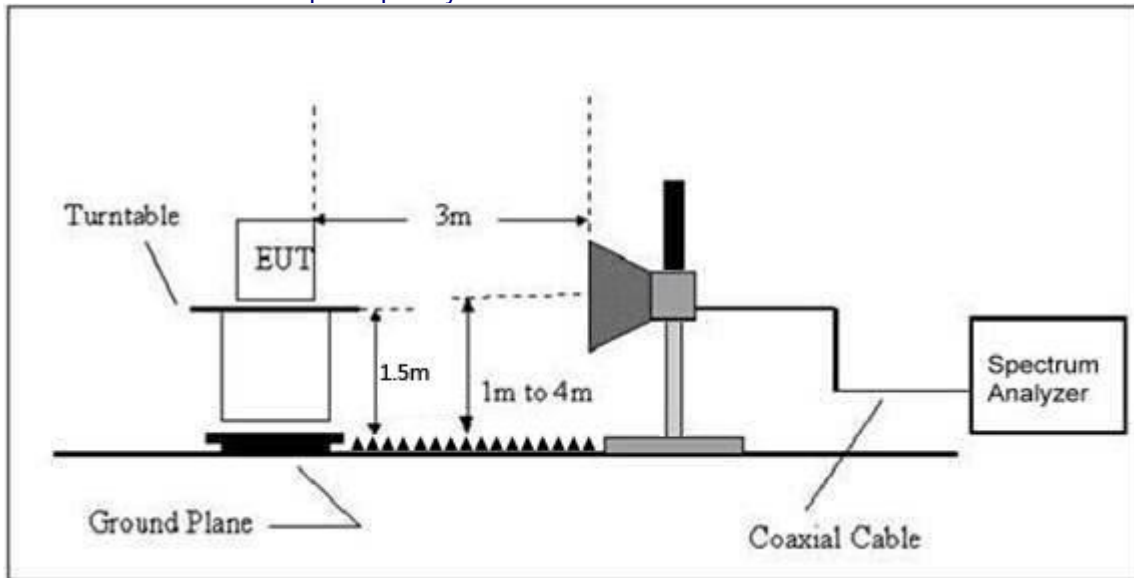

5.5 EUT OPERATING CONDITIONS

The EUT tested system was configured as the statements of 2.3 Unless otherwise a special operating condition is specified in the follows during the testing.

5.6 TEST RESULT

	Polar (H/V)	Frequency (MHz)	Meter Reading (dBuV)	Pre-amplifier (dB)	Cable Loss (dB)	Antenna Factor (dB/m)	Emission level (dBuV/m)	Limit (dBuV/m)	Detector Type	Result
GFSK	Low Channel: 2402MHz									
	H	2390.00	53.78	30.22	4.85	23.98	52.39	74.00	PK	PASS
	H	2390.00	44.80	30.22	4.85	23.98	43.41	54.00	AV	PASS
	H	2400.00	54.41	30.22	4.85	23.98	53.02	74.00	PK	PASS
	H	2400.00	44.85	30.22	4.85	23.98	43.46	54.00	AV	PASS
	V	2390.00	54.91	30.22	4.85	23.98	53.52	74.00	PK	PASS
	V	2390.00	44.99	30.22	4.85	23.98	43.60	54.00	AV	PASS
	V	2400.00	53.93	30.22	4.85	23.98	52.54	74.00	PK	PASS
	V	2400.00	44.30	30.22	4.85	23.98	42.91	54.00	AV	PASS
	High Channel: 2480MHz									
	H	2483.50	54.76	30.22	4.85	23.98	53.37	74.00	PK	PASS
	H	2483.50	44.85	30.22	4.85	23.98	43.46	54.00	AV	PASS
	H	2500.00	54.56	30.22	4.85	23.98	53.17	74.00	PK	PASS
	H	2500.00	44.71	30.22	4.85	23.98	43.32	54.00	AV	PASS
	V	2483.50	54.15	30.22	4.85	23.98	52.76	74.00	PK	PASS
	V	2483.50	44.86	30.22	4.85	23.98	43.47	54.00	AV	PASS
	V	2500.00	53.40	30.22	4.85	23.98	52.01	74.00	PK	PASS
	V	2500.00	44.61	30.22	4.85	23.98	43.22	54.00	AV	PASS
Remark:										
1. Emission Level = Meter Reading + Antenna Factor + Cable Loss – Pre-amplifier, Margin= Emission Level - Limit										

6.POWER SPECTRAL DENSITY TEST

Test Requirement:	FCC Part15 C Section 15.247 (e)
Test Method:	KDB558074 D0115.247 Meas Guidance v05r02

6.1 APPLIED PROCEDURES / LIMIT

FCC Part15 (15.247) , Subpart C				
Section	Test Item	Limit	Frequency Range (MHz)	Result
15.247	Power Spectral Density	8dBm/3kHz	2400-2483.5	PASS

6.2 TEST PROCEDURE

1. Set analyzer center frequency to DTS channel center frequency.
2. Set the span to 1.5 times the DTS bandwidth.
3. Set the RBW to: $3\text{ kHz} \leq \text{RBW} \leq 100\text{ kHz}$.
4. Set the VBW $\geq 3 \times \text{RBW}$.
5. Detector = peak.
6. Sweep time = auto couple.
7. Trace mode = max hold.
8. Allow trace to fully stabilize.
9. Use the peak marker function to determine the maximum amplitude level within the RBW.
10. If measured value exceeds limit, reduce RBW (no less than 3 kHz) and repeat.

6.3 DEVIATION FROM STANDARD

No deviation.

6.4 TEST SETUP



6.5 EUT OPERATION CONDITIONS

The EUT tested system was configured as the statements of 2.1 Unless otherwise a special operating condition is specified in the follows during the testing.

6.6 TEST RESULT

Temperature :	26°C	Relative Humidity :	54%
Test Mode :	GFSK	Test Voltage :	AC 120V/60Hz

Frequency	Power Spectral Density (dBm/3kHz)	Limit (dBm/3kHz)	Result
2402 MHz	-13.9	8	PASS
2440 MHz	-14.24	8	PASS
2480 MHz	-16.07	8	PASS

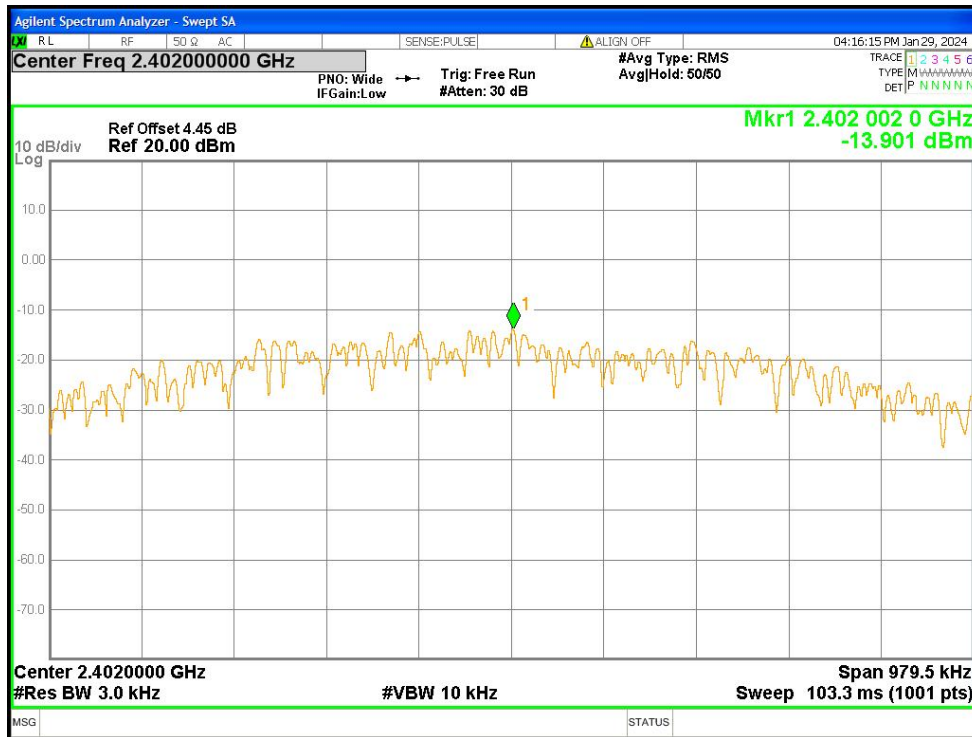

PSD NVNT BLE 1M 2402MHz Ant1

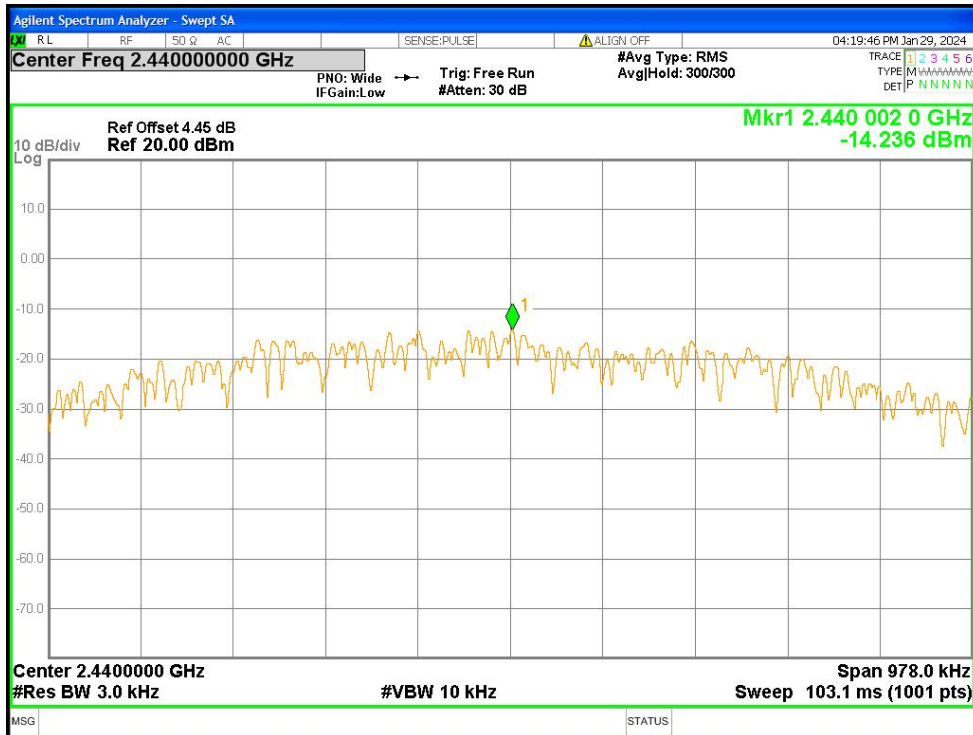

PSD NVNT BLE 1M 2440MHz Ant1

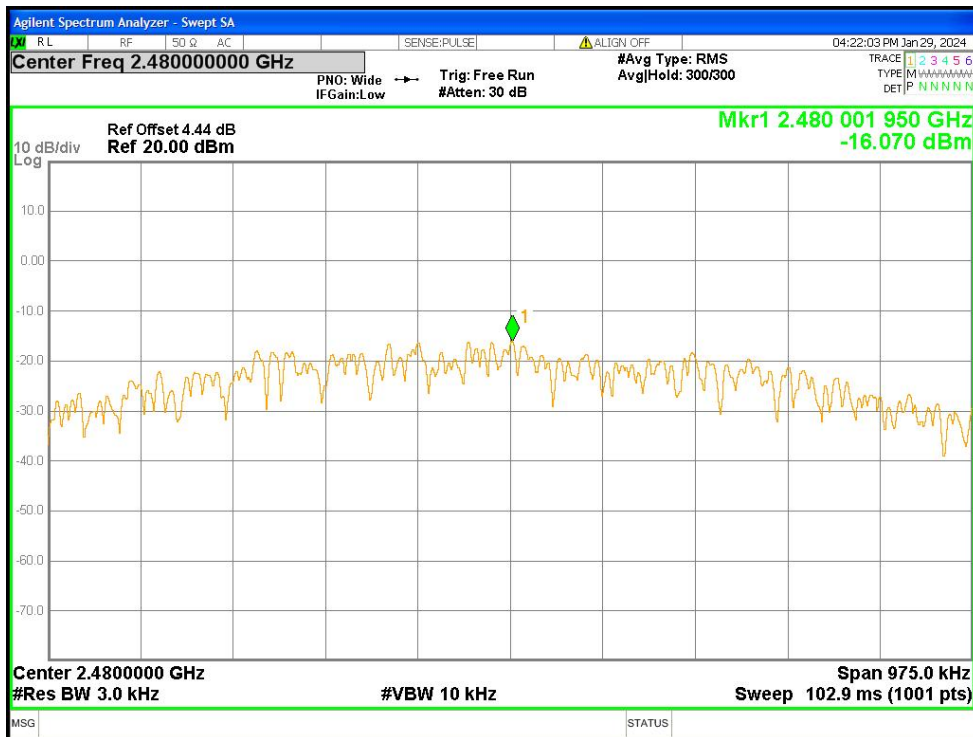

PSD NVNT BLE 1M 2480MHz Ant1

7. CHANNEL BANDWIDTH

Test Requirement:	FCC Part15 C Section 15.247 (a)(2)
Test Method:	KDB558074 D0115.247 Meas Guidance v05r02

7.1 APPLIED PROCEDURES / LIMIT

FCC Part15 (15.247) , Subpart C				
Section	Test Item	Limit	Frequency Range (MHz)	Result
15.247(a)(2)	Bandwidth	$\geq 500\text{KHz}$ (6dB bandwidth)	2400-2483.5	PASS

7.2 TEST PROCEDURE

1. Set RBW = 100 kHz.
2. Set the video bandwidth (VBW) $\geq 3 \times$ RBW.
3. Detector = Peak.
4. Trace mode = max hold.
5. Sweep = auto couple.
6. Allow the trace to stabilize.
7. Measure the maximum width of the emission that is constrained by the frequencies associated with the two outermost amplitude points (upper and lower frequencies) that are attenuated by 6 dB relative to the maximum level measured in the fundamental emission.

7.3 DEVIATION FROM STANDARD

No deviation.

7.4 TEST SETUP



7.5 EUT OPERATION CONDITIONS

The EUT tested system was configured as the statements of 2.4 Unless otherwise a special operating condition is specified in the follows during the testing.

7.6 TEST RESULT

Temperature :	26°C	Relative Humidity :	54%
Test Mode :	GFSK	Test Voltage :	AC 120V/60Hz

Test channel	Channel Bandwidth (MHz)	Limit(KHz)	Result
Lowest	0.653	>500	Pass
Middle	0.652		
Highest	0.65		

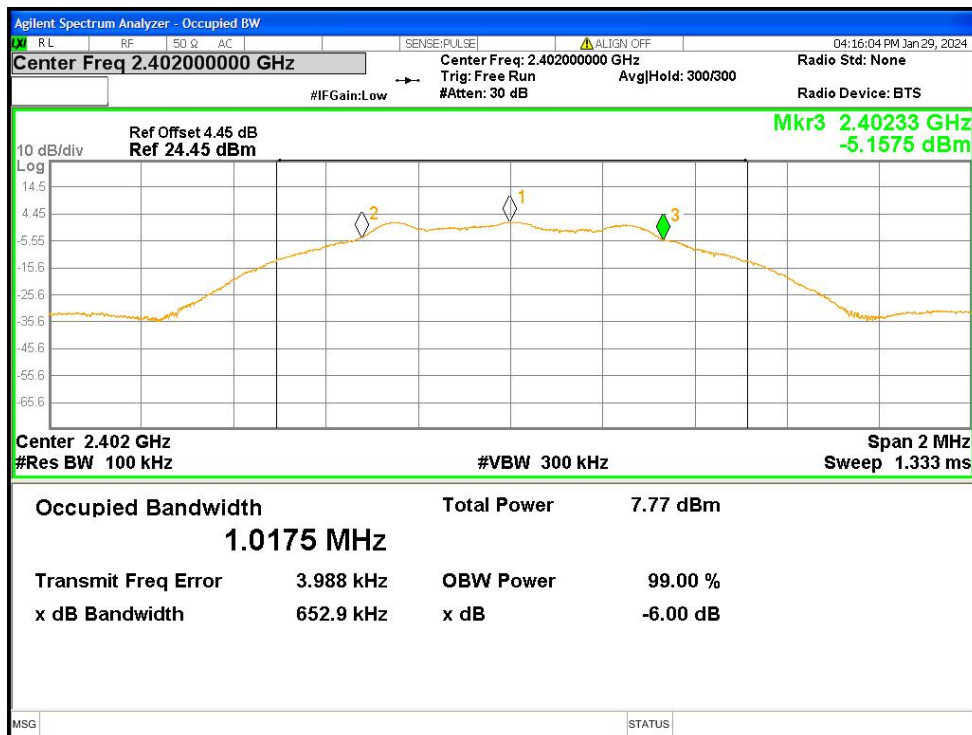

-6dB Bandwidth NVNT BLE 1M 2402MHz Ant1

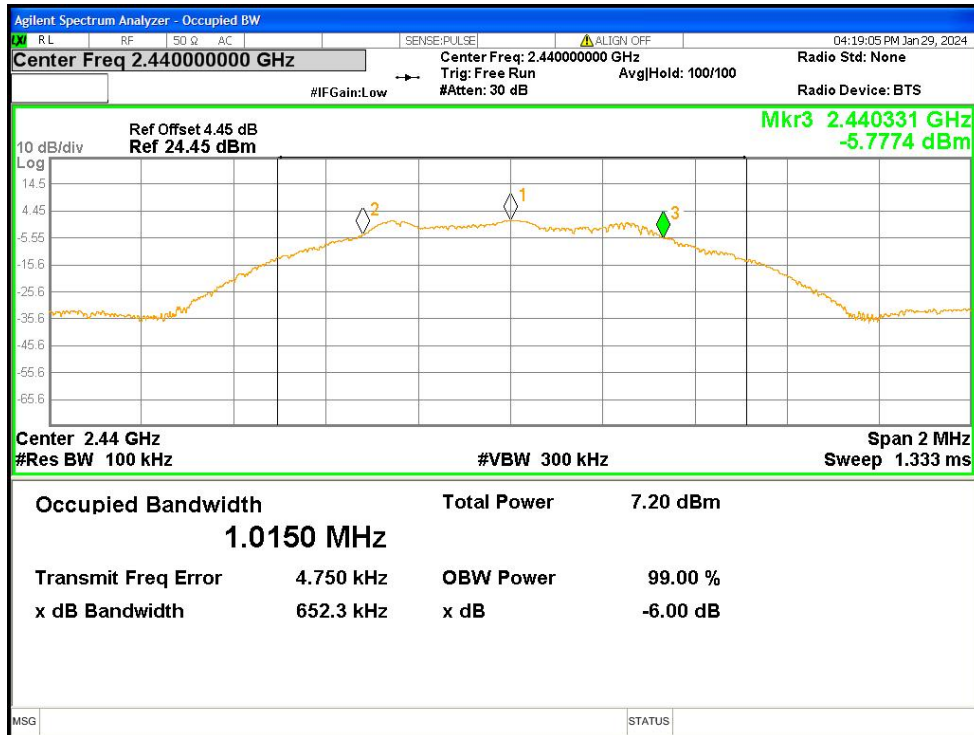

-6dB Bandwidth NVNT BLE 1M 2440MHz Ant1

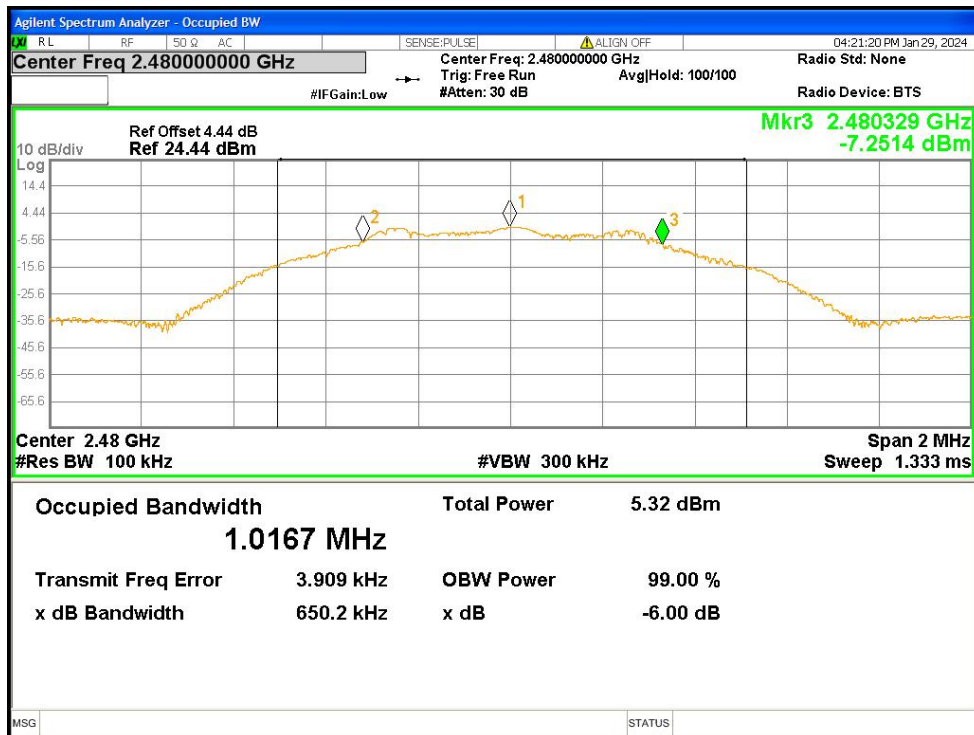

-6dB Bandwidth NVNT BLE 1M 2480MHz Ant1

8. PEAK OUTPUT POWER TEST

Test Requirement:	FCC Part15 C Section 15.247 (b)(3)
Test Method:	KDB558074 D0115.247 Meas Guidance v05r02

8.1 APPLIED PROCEDURES / LIMIT

FCC Part15 (15.247) , Subpart C				
Section	Test Item	Limit	Frequency Range (MHz)	Result
15.247(b)(3)	Peak Output Power	1 watt or 30dBm	2400-2483.5	PASS

8.2 TEST PROCEDURE

- a. The EUT was directly connected to the Power meter

8.3 DEVIATION FROM STANDARD

No deviation.

8.4 TEST SETUP**8.5 EUT OPERATION CONDITIONS**

The EUT tested system was configured as the statements of 2.4 Unless otherwise a special operating condition is specified in the follows during the testing.

8.6 TEST RESULT

Temperature :	26°C	Relative Humidity :	54%
Test Mode :	GFSK	Test Voltage :	AC 120V/60Hz

Test channel	Peak Output Power (dBm)	Limit(dBm)	Result
Lowest	1.87	30.00	Pass
Middle	1.52		
Highest	-0.34		

9. CONDUCTED BAND EDGE AND SPURIOUS EMISSION

Test Requirement:	FCC Part15 C Section 15.247 (d)
Test Method:	KDB558074 D0115.247 Meas Guidance v05r02

9.1 APPLICABLE STANDARD

In any 100 kHz bandwidth outside the frequency band in which the spread spectrum intentional radiator is operating, the radio frequency power that is produced by the intentional radiator shall be at least 20 dB below that in the 100 kHz bandwidth within the band that contains the highest level of the desired power, based on either an RF conducted or a radiated measurement.

9.2 TEST PROCEDURE

Using the following spectrum analyzer setting:

- A) Set the RBW = 100KHz.
- B) Set the VBW = 300KHz.
- C) Sweep time = auto couple.
- D) Detector function = peak.
- E) Trace mode = max hold.
- F) Allow trace to fully stabilize.

9.3 DEVIATION FROM STANDARD

No deviation.

9.4 TEST SETUP



9.5 EUT OPERATION CONDITIONS

The EUT tested system was configured as the statements of 2.4 Unless otherwise a special operating condition is specified in the follows during the testing.

9.6 TEST RESULTS

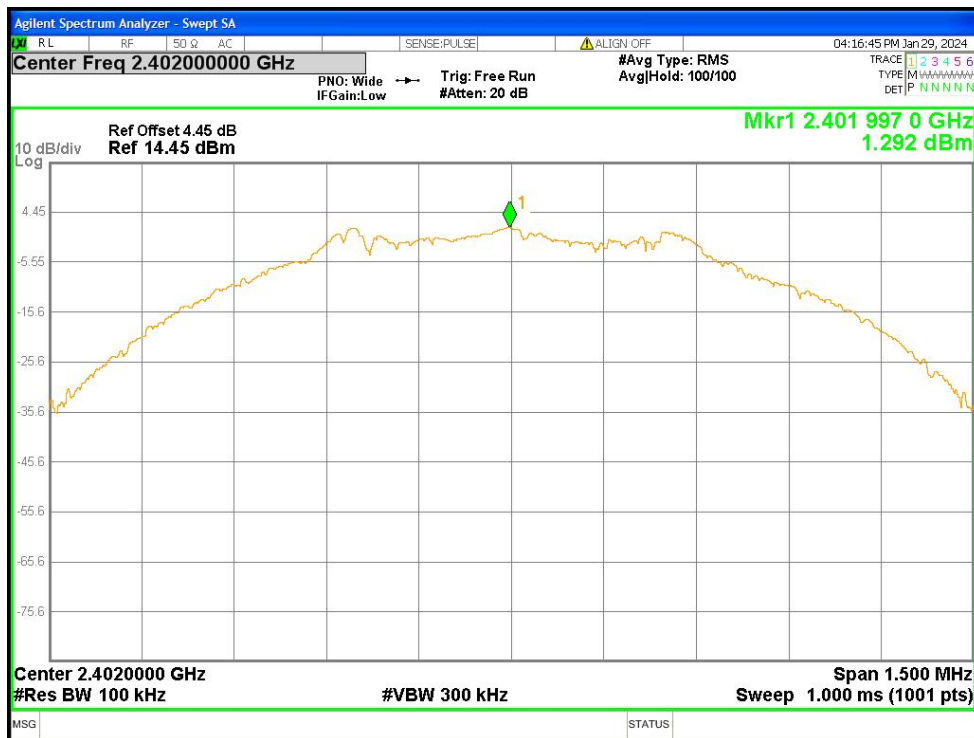

Tx. Spurious NVNT BLE 1M 2402MHz Ant1 Ref

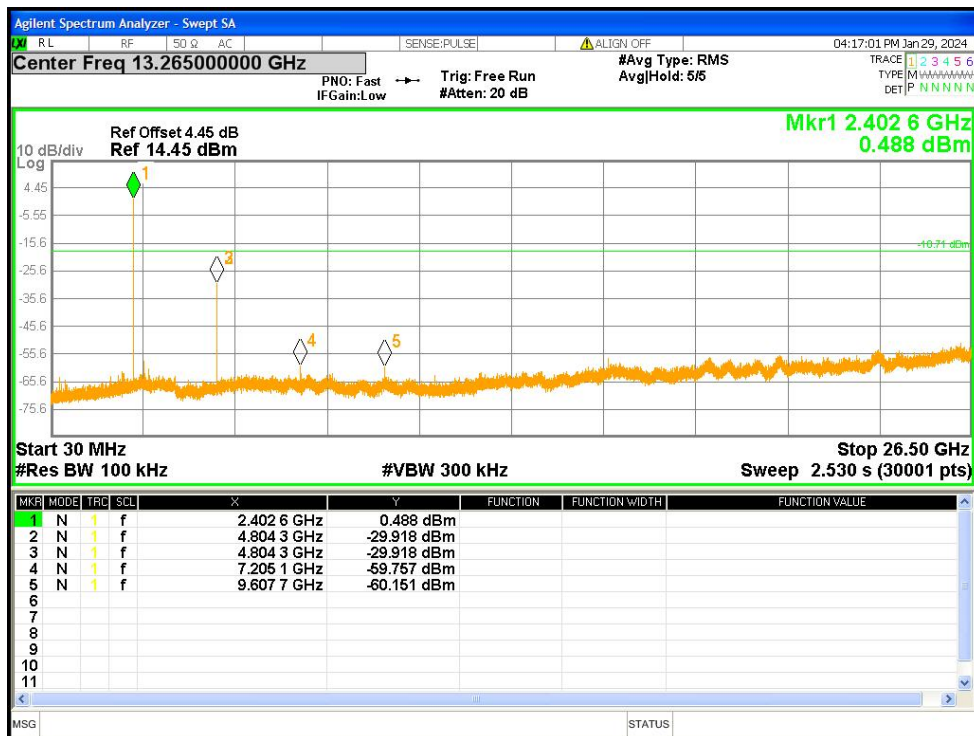

Tx. Spurious NVNT BLE 1M 2402MHz Ant1 Emission

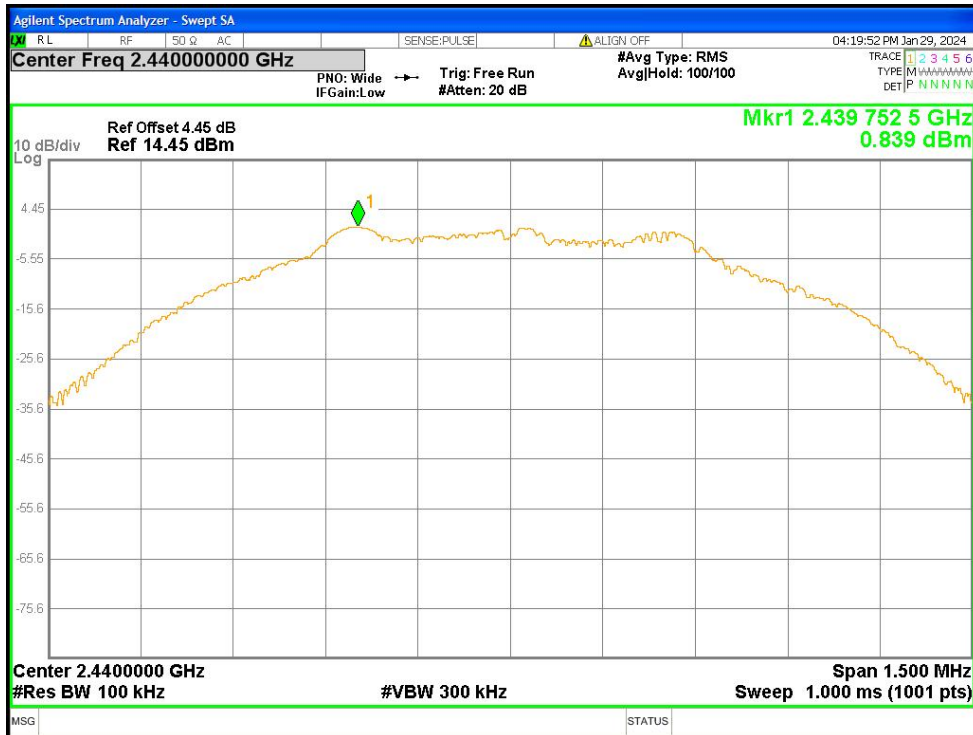

Tx. Spurious NVNT BLE 1M 2440MHz Ant1 Ref

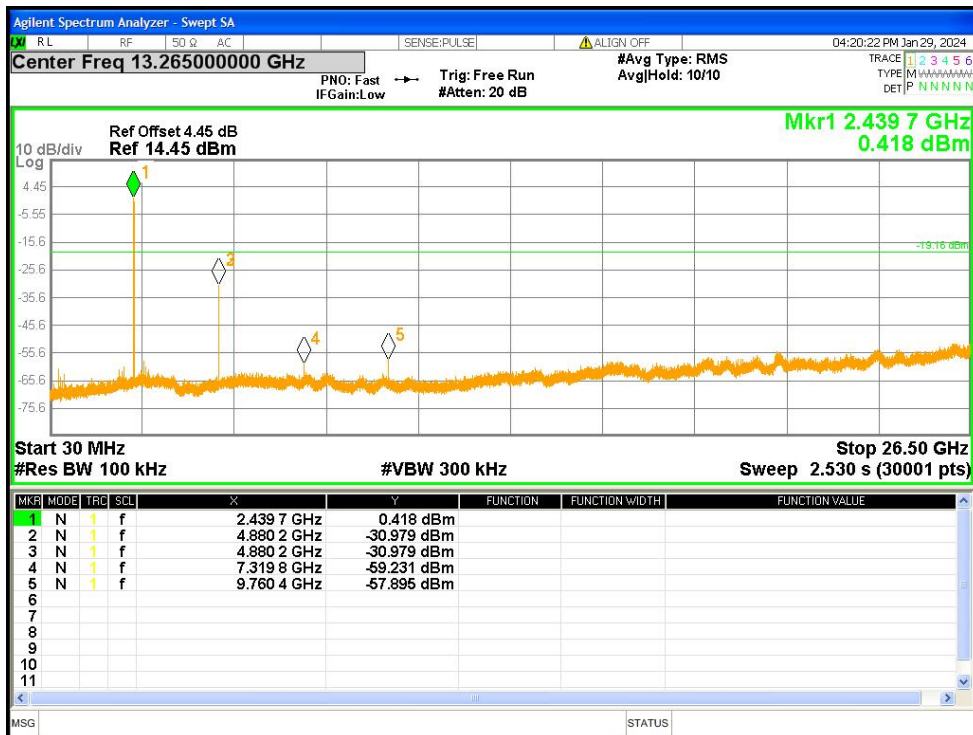

Tx. Spurious NVNT BLE 1M 2440MHz Ant1 Emission

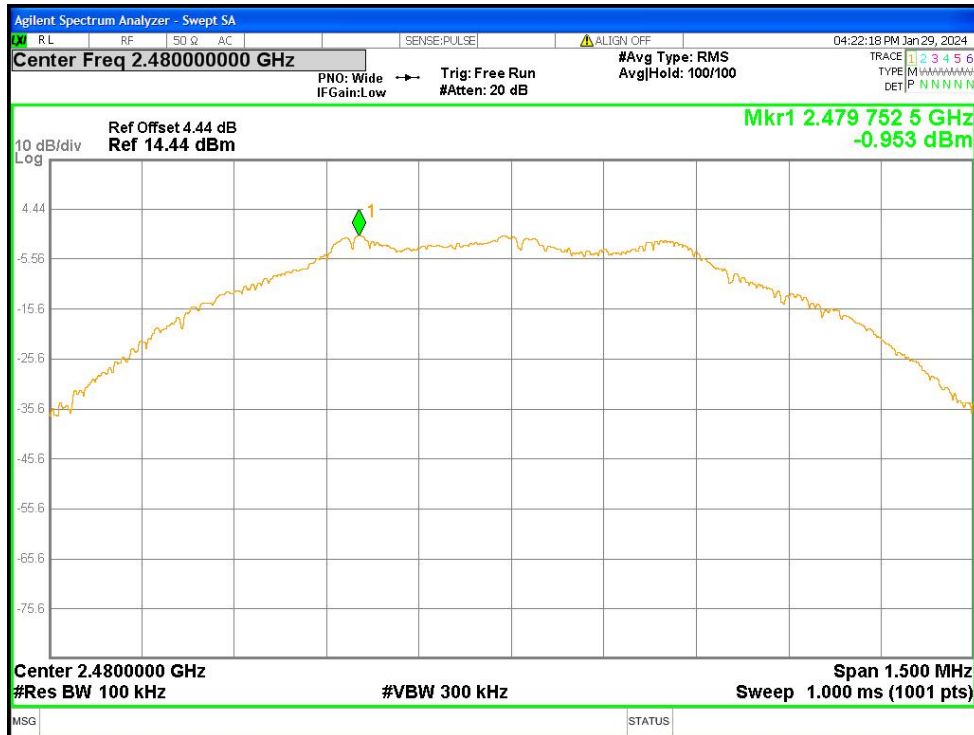

Tx. Spurious NVNT BLE 1M 2480MHz Ant1 Ref

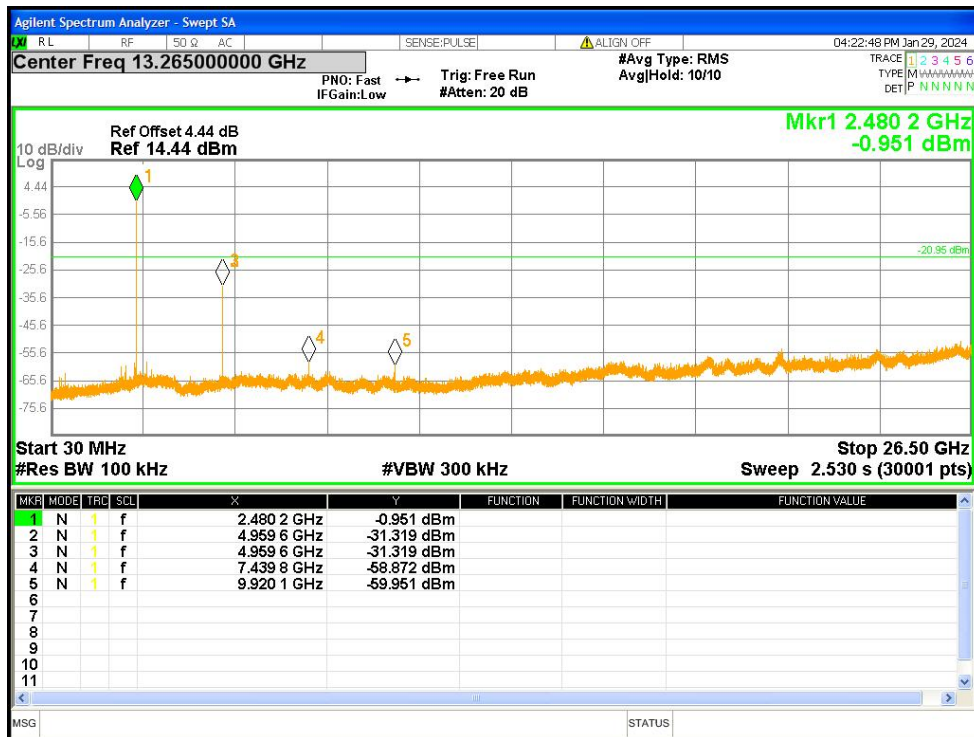

Tx. Spurious NVNT BLE 1M 2480MHz Ant1 Emission

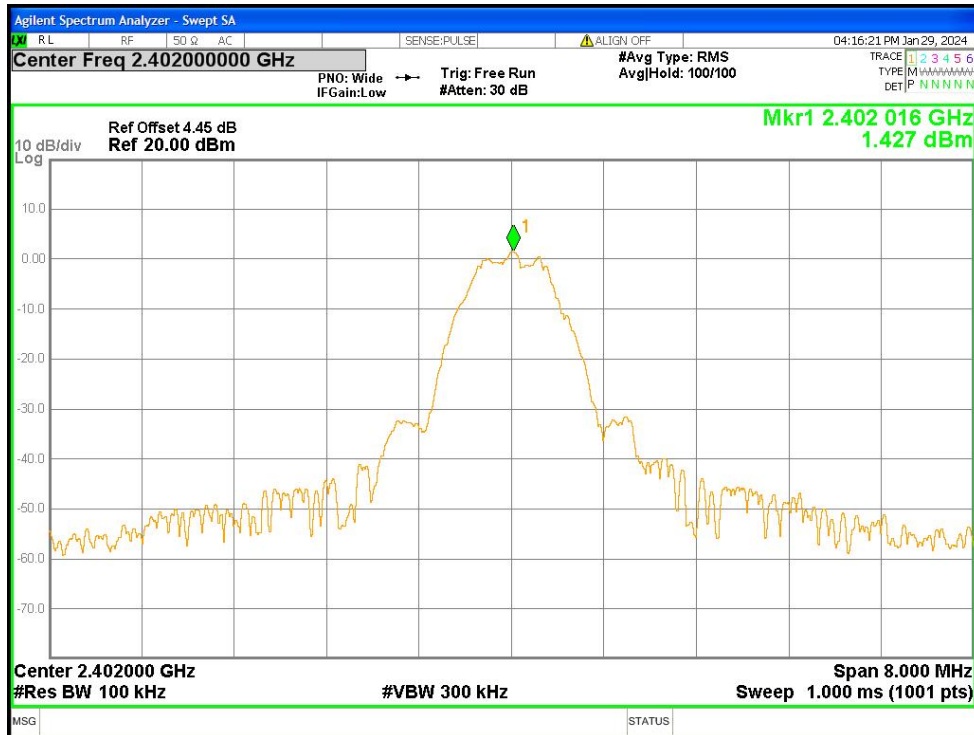

Band Edge NVNT BLE 1M 2402MHz Ant1 Ref

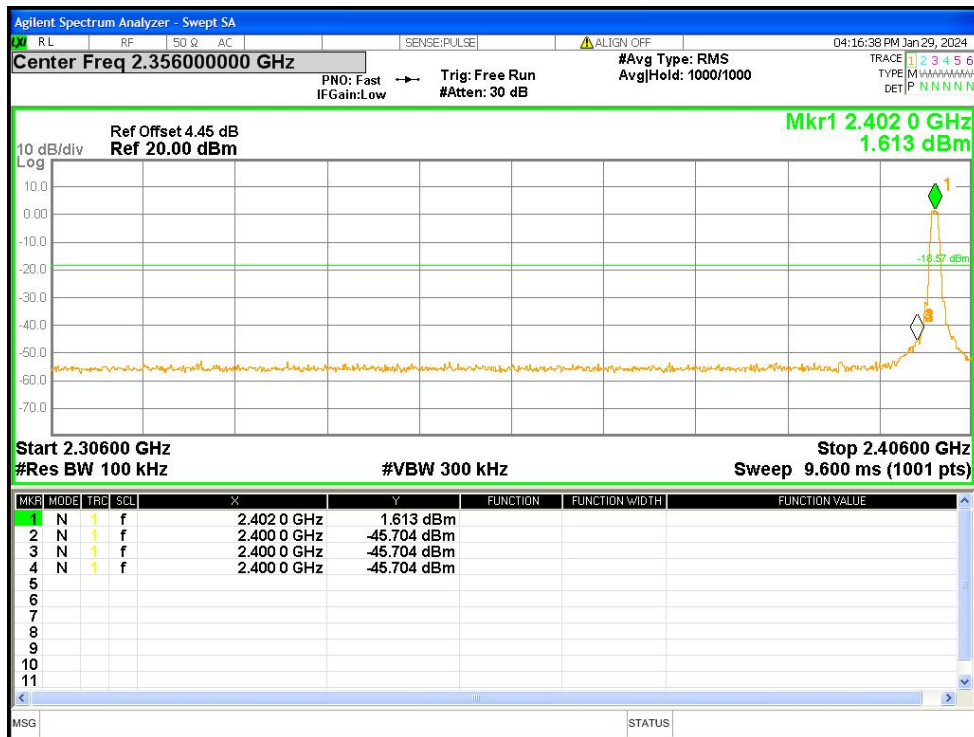

Band Edge NVNT BLE 1M 2402MHz Ant1 Emission

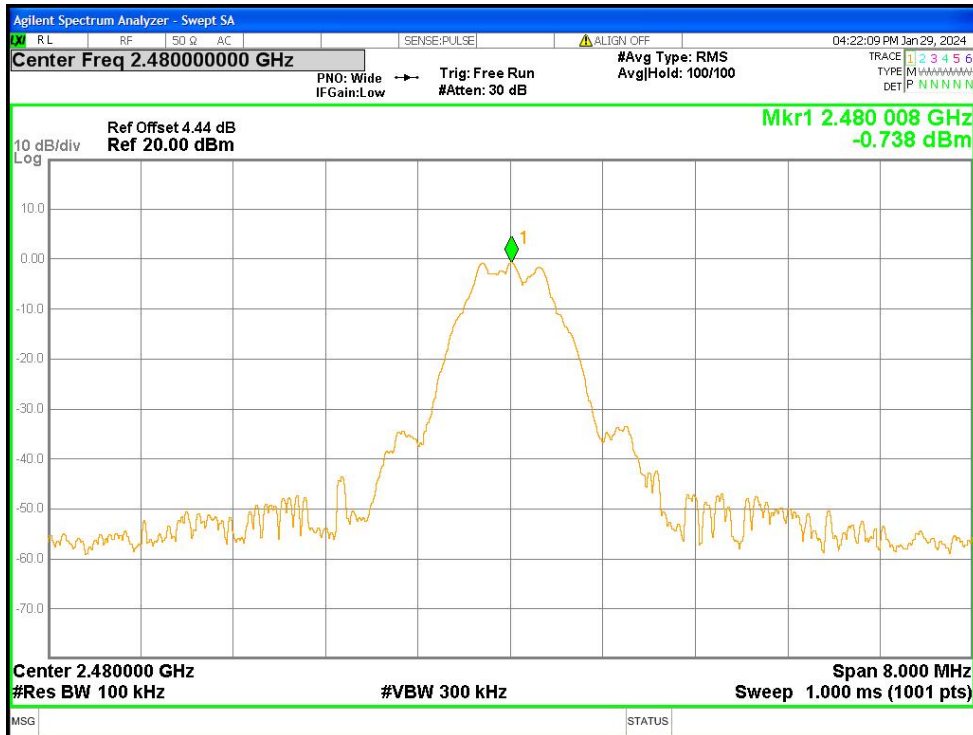

Band Edge NVNT BLE 1M 2480MHz Ant1 Ref

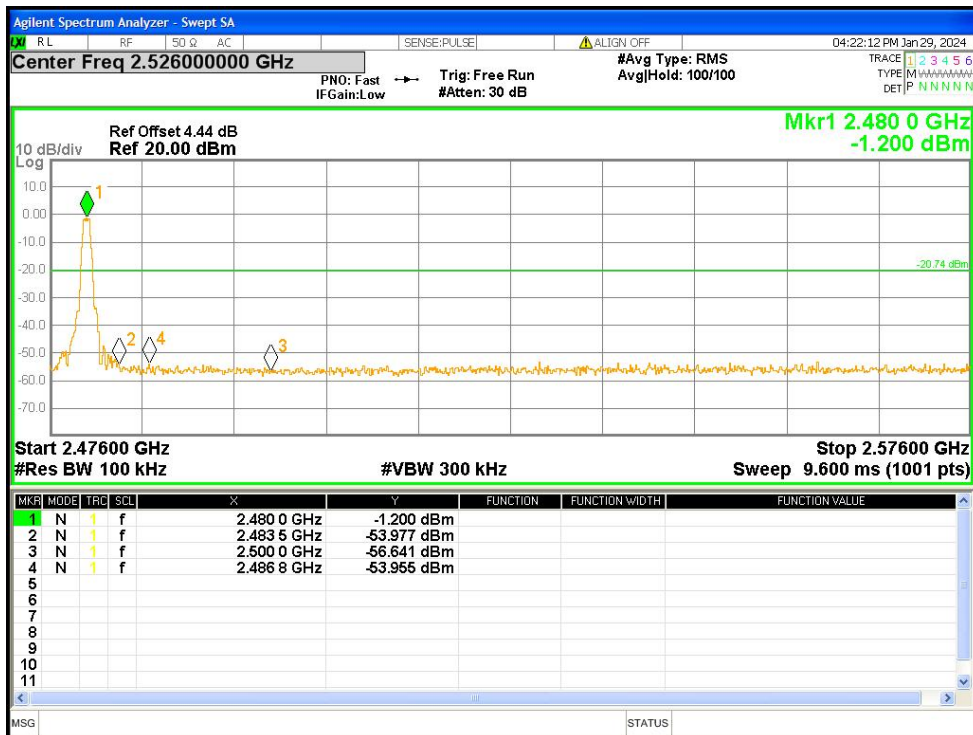

Band Edge NVNT BLE 1M 2480MHz Ant1 Emission

10.ANTENNA REQUIREMENT

Standard requirement:	FCC Part15 C Section 15.203 /247(c)
<p>15.203 requirement: An intentional radiator shall be designed to ensure that no antenna other than that furnished by the responsible party shall be used with the device. The use of a permanently attached antenna or of an antenna that uses a unique coupling to the intentional radiator, the manufacturer may design the unit so that a broken antenna can be replaced by the user, but the use of a standard antenna jack or electrical connector is prohibited.</p> <p>15.247(c) (1)(i) requirement: (i) Systems operating in the 2400-2483.5 MHz band that is used exclusively for fixed. Point-to-point operations may employ transmitting antennas with directional gain greater than 6dBi provided the maximum conducted output power of the intentional radiator is reduced by 1 dB for every 3 dB that the directional gain of the antenna exceeds 6dBi.</p>	
EUT Antenna:	
The antenna is a Internal antenna , the best case gain of the antenna is 3.53dBi, reference to the appendix II for details	

11. TEST SETUP PHOTO

Reference to the appendix I for details.

12. EUT CONSTRUCTIONAL DETAILS

Reference to the appendix II for details.

******* END OF REPORT *******