

TEST REPORT

FCC Rules Part 15.247

Report Reference No.....: MTEB24080225-R

FCC ID..... : 2A9MI-X2-PRO

Compiled by

(position+printed name+signature)..: File administrators Alisa Luo



Supervised by

(position+printed name+signature)..: Test Engineer Sunny Deng



Approved by

(position+printed name+signature)..: Manager Yvette Zhou



Date of issue.....: **Aug. 16, 2024**

Representative Laboratory Name. : Shenzhen Most Technology Service Co., Ltd.

Address.....: No.5, 2nd Langshan Road, North District, Hi-tech Industrial Park,
Nanshan, Shenzhen, Guangdong, China.

Applicant's name.....: Shenzhen Yixi Technology Co., LTD

Address.....: Second Floor, Building B, Area A, Longquan Science Park, Dalang
Huaxing Road, Longhua District, Shenzhen City,China

Test specification/ Standard.....: FCC Rules Part 15.247

TRF Originator.....: Shenzhen Most Technology Service Co., Ltd.

Shenzhen Most Technology Service Co., Ltd. All rights reserved.

This publication may be reproduced in whole or in part for non-commercial purposes as long as the Shenzhen Most Technology Service Co., Ltd. is acknowledged as copyright owner and source of the material. Shenzhen Most Technology Service Co., Ltd. takes no responsibility for and will not assume liability for damages resulting from the reader's interpretation of the reproduced material due to its placement and context.

Test item description.....: HELMET WIRELESS EARPHONE

Trade Mark.....: N/A

Model/Type reference.....: X2-pro

Listed Models: NX-X2

Modulation Type.....: GFSK, π/4DQPSK, 8DPSK

Operation Frequency.....: From 2402MHz to 2480MHz

Hardware Version.....: V1.0

Software Version.....: V1.2

Rating.....: DC 3.7V by Battery
DC 5V by USB Port

Result.....: **PASS**

TEST REPORT

Equipment under Test : HELMET WIRELESS EARPHONE

Model /Type : X2-pro

Listed Models : NX-X2

Remark : Only the model name is different, other designs are the same

Applicant : **Shenzhen Yixi Technology Co., LTD**

Address : Second Floor, Building B, Area A, Longquan Science Park, Dalang Huaxing Road, Longhua District, Shenzhen City,China

Manufacturer : **Shenzhen Yixi Technology Co., LTD**

Address : Second Floor, Building B, Area A, Longquan Science Park, Dalang Huaxing Road, Longhua District, Shenzhen City,China

Test Result:	PASS
---------------------	-------------

The test report merely corresponds to the test sample.
It is not permitted to copy extracts of these test result without the written permission of the test laboratory.

Contents

1 REVISION HISTORY	4
2 TEST STANDARDS	5
3 SUMMARY	6
3.1 General Remarks	6
3.2 Product Description	6
3.3 Equipment Under Test	6
3.4 Short description of the Equipment under Test (EUT)	6
3.5 EUT operation mode	7
3.6 Block Diagram of Test Setup	7
3.7 Test Item (Equipment Under Test) Description*	7
3.8 Auxiliary Equipment (AE) Description	7
3.9 Antenna Information*	7
3.10 Related Submittal(s) / Grant (s)	8
3.11 Modifications	8
3.12 EUT configuration	8
4 TEST ENVIRONMENT	9
4.1 Address of the test laboratory	9
4.2 Environmental conditions	9
4.3 Summary of measurement results	10
4.4 Statement of the measurement uncertainty	10
4.5 Equipments Used during the Test	11
5 TEST CONDITIONS AND RESULTS	12
5.1 AC Power Conducted Emission	12
5.2 Radiated Emission	15
5.3 Maximum Peak Output Power	21
5.4 20dB Bandwidth	22
5.5 Frequency Separation	23
5.6 Number of hopping frequency	24
5.7 Time of Occupancy (Dwell Time)	25
5.8 Spurious RF Conducted Emission	26
5.9 Pseudorandom Frequency Hopping Sequence	27
5.10 Antenna Requirement	28
6 TEST SETUP PHOTOS OF THE EUT	29
7 PHOTOS OF THE EUT	30
APPENDIX I.Duty Cycle	31
APPENDIX II.Dwell Time	36
APPENDIX III.Number Of Hopping Channel	39
APPENDIX IV.Conducted Peak Output Power	41
APPENDIX V.99% Bandwidth	42
APPENDIX VI.20dB Bandwidth	44
APPENDIX VII.Carrier Frequencies Separation	46
APPENDIX VIII.Conducted Out Of Band Emission	48

1 Revision History

Revision	Issue Date	Revisions	Revised By
00	2024.08.16	Initial Issue	Alisa Luo

2 TEST STANDARDS

The tests were performed according to following standards:

[FCC Rules Part 15.247](#): Frequency Hopping, Direct Spread Spectrum and Hybrid Systems that are in operation within the bands of 902-928 MHz, 2400-2483.5 MHz, and 5725-5850 MHz.

[ANSI C63.10-2013](#): American National Standard for Testing Unlicensed Wireless Devices

3 SUMMARY

3.1 General Remarks

Date of receipt of test sample	:	2024.08.12
Testing commenced on	:	2024.08.13
Testing concluded on	:	2024.08.16

3.2 Product Description

Product Name:	HELMET WIRELESS EARPHONE
Model/Type reference:	X2-pro
Power Supply:	DC 3.7V by Battery DC 5V by USB Port
Testing sample ID:	MTYP06441
Bluetooth :	
Supported Type:	Bluetooth BR/EDR
Modulation:	GFSK, $\pi/4$ DQPSK, 8DPSK
Operation frequency:	2402MHz~2480MHz
Channel number:	79
Channel separation:	1MHz
Antenna type:	Ceramic antenna
Antenna gain:	2.06dBi

3.3 Equipment Under Test

Power supply system utilised

Power supply voltage	:	<input type="radio"/> 230V / 50 Hz	<input type="radio"/> 120V / 60Hz
		<input type="radio"/> 12 V DC	<input type="radio"/> 24 V DC
		<input checked="" type="radio"/> Other (specified in blank below)	

DC 3.7V by Battery
DC 5V by USB Port

3.4 Short description of the Equipment under Test (EUT)

This is a HELMET WIRELESS EARPHONE For more details, refer to the user's manual of the EUT.

3.5 EUT operation mode

The Applicant provides communication tools software(Engineer mode) to control the EUT for staying in continuous transmitting (Duty Cycle more than 98%) and receiving mode for testing .There are 79 channels provided to the EUT and Channel 00/39/78 were selected to test.

Operation Frequency:

Channel	Frequency (MHz)
00	2402
01	2403
⋮	⋮
38	2440
39	2441
40	2442
⋮	⋮
77	2479
78	2480

3.6 Block Diagram of Test Setup

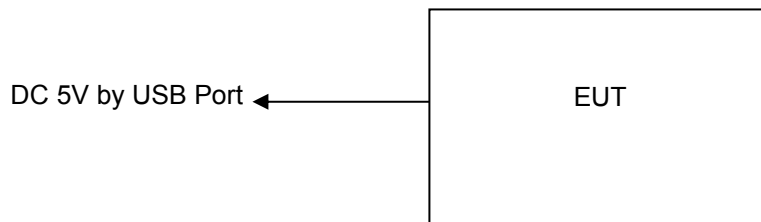

3.7 Test Item (Equipment Under Test) Description*

Short designation	EUT Name	EUT Description	Serial number	Hardware status	Software status
EUT A					
EUT B					

*: declared by the applicant. According to customers information EUTs A and B are the same devices.

3.8 Auxiliary Equipment (AE) Description

AE short designation	EUT Name (if available)	EUT Description	Serial number (if available)	Software (if used)
AE 1	Adapter	UP0512		

3.9 Antenna Information*

Short designation	Antenna Name	Antenna Type	Frequency Range	Serial number	Antenna Peak Gain
Antenna 1	---	Ceramic antenna	2.4 – 2.5 GHz	---	2.06dBi
Antenna 2					

*: declared by the applicant.

3.10 Related Submittal(s) / Grant (s)

This submittal(s) (test report) is intended for the device filing to comply with Section 15.247 of the FCC Part 15, Subpart C Rules.

3.11 Modifications

No modifications were implemented to meet testing criteria.

3.12 EUT configuration

The following peripheral devices and interface cables were connected during the measurement:

- supplied by the manufacturer

- Supplied by the lab

<input checked="" type="radio"/>	ADAPTER	M/N:	UP0512
<input type="radio"/>		Manufacturer:	Salcomp (Shenzhen) Co., Ltd.

4 TEST ENVIRONMENT

4.1 Address of the test laboratory

Shenzhen Most Technology Service Co., Ltd.

No.5, 2nd Langshan Road, North District, Hi-tech Industrial Park, Nanshan, Shenzhen, Guangdong, China.
The 3m-Semi anechoic test site fulfils CISPR 16-1-4 according to ANSI C63.4:2014 and CISPR 16-1-4:2010 SVSWR requirement for radiated emission above 1GHz.

Test Facility

The test facility is recognized, certified, or accredited by the following organizations:

FCC-Designation No.: CN1315

Shenzhen Most Technology Service Co., Ltd. EMC Laboratory has been registered and fully described in a report filed with the (FCC) Federal Communications Commission. The acceptance letter from the FCC is maintained in our files.

A2LA-Lab Cert. No.: 6343.01

Shenzhen Most Technology Service Co., Ltd. EMC Laboratory has been accredited by A2LA for technical competence in the field of electrical testing, and proved to be in compliance with ISO/IEC 17025: 2005 General Requirements for the Competence of Testing and Calibration Laboratories and any additional program requirements in the identified field of testing.

4.2 Environmental conditions

During the measurement the environmental conditions were within the listed ranges:

Radiated Emission:

Temperature:	23 ° C
Humidity:	48 %
Atmospheric pressure:	950-1050mbar

AC Main Conducted testing:

Temperature:	24 ° C
Humidity:	45 %
Atmospheric pressure:	950-1050mbar

Conducted testing:

Temperature:	24 ° C
Humidity:	45 %
Atmospheric pressure:	950-1050mbar

4.3 Summary of measurement results

Test Specification clause	Test case	Test Mode	Test Channel	Recorded In Report		Test result
§15.247(a)(1)	Carrier Frequency separation	GFSK Π/4DQPSK 8DPSK	<input checked="" type="checkbox"/> Lowest <input checked="" type="checkbox"/> Middle <input checked="" type="checkbox"/> Highest	GFSK Π/4DQPSK 8DPSK	<input checked="" type="checkbox"/> Middle	Compliant
§15.247(a)(1)	Number of Hopping channels	GFSK Π/4DQPSK 8DPSK	<input checked="" type="checkbox"/> Full	GFSK 8DPSK	<input checked="" type="checkbox"/> Full	Compliant
§15.247(a)(1)	Time of Occupancy (dwell time)	GFSK Π/4DQPSK 8DPSK	<input checked="" type="checkbox"/> Lowest <input checked="" type="checkbox"/> Middle <input checked="" type="checkbox"/> Highest	GFSK Π/4DQPSK 8DPSK	<input checked="" type="checkbox"/> Middle	Compliant
§15.247(a)(1)	Spectrum bandwidth of aFHSS system 20dB bandwidth	GFSK Π/4DQPSK 8DPSK	<input checked="" type="checkbox"/> Lowest <input checked="" type="checkbox"/> Middle <input checked="" type="checkbox"/> Highest	GFSK Π/4DQPSK 8DPSK	<input checked="" type="checkbox"/> Lowest <input checked="" type="checkbox"/> Middle <input checked="" type="checkbox"/> Highest	Compliant
§15.247(b)(1)	Maximum output power	GFSK Π/4DQPSK 8DPSK	<input checked="" type="checkbox"/> Lowest <input checked="" type="checkbox"/> Middle <input checked="" type="checkbox"/> Highest	GFSK Π/4DQPSK 8DPSK	<input checked="" type="checkbox"/> Lowest <input checked="" type="checkbox"/> Middle <input checked="" type="checkbox"/> Highest	Compliant
§15.247(d)	Band edge compliance conducted	GFSK Π/4DQPSK 8DPSK	<input checked="" type="checkbox"/> Lowest <input checked="" type="checkbox"/> Highest	GFSK Π/4DQPSK 8DPSK	<input checked="" type="checkbox"/> Lowest <input checked="" type="checkbox"/> Highest	Compliant
§15.205	Band edge compliance radiated	GFSK Π/4DQPSK 8DPSK	<input checked="" type="checkbox"/> Lowest <input checked="" type="checkbox"/> Highest	GFSK	<input checked="" type="checkbox"/> Lowest <input checked="" type="checkbox"/> Highest	Compliant
§15.247(d)	TX spurious emissions conducted	GFSK Π/4DQPSK 8DPSK	<input checked="" type="checkbox"/> Lowest <input checked="" type="checkbox"/> Middle <input checked="" type="checkbox"/> Highest	GFSK Π/4DQPSK 8DPSK	<input checked="" type="checkbox"/> Lowest <input checked="" type="checkbox"/> Middle <input checked="" type="checkbox"/> Highest	Compliant
§15.247(d)	TX spurious emissions radiated	GFSK Π/4DQPSK 8DPSK	<input checked="" type="checkbox"/> Lowest <input checked="" type="checkbox"/> Middle <input checked="" type="checkbox"/> Highest	GFSK	<input checked="" type="checkbox"/> Lowest <input checked="" type="checkbox"/> Middle <input checked="" type="checkbox"/> Highest	Compliant
§15.209(a)	TX spurious Emissions radiated Below 1GHz	GFSK Π/4DQPSK 8DPSK	<input checked="" type="checkbox"/> Lowest <input checked="" type="checkbox"/> Middle <input checked="" type="checkbox"/> Highest	GFSK	<input checked="" type="checkbox"/> Middle	Compliant
§15.107(a) §15.207	Conducted Emissions 9KHz-30 MHz	GFSK Π/4DQPSK 8DPSK	<input checked="" type="checkbox"/> Lowest <input checked="" type="checkbox"/> Middle <input checked="" type="checkbox"/> Highest	GFSK	<input checked="" type="checkbox"/> Middle	Compliant

Remark:

1. The measurement uncertainty is not included in the test result.
2. We tested all test mode and recorded worst case in report

4.4 Statement of the measurement uncertainty

The data and results referenced in this document are true and accurate. The reader is cautioned that there may be errors within the calibration limits of the equipment and facilities. The measurement uncertainty was calculated for all measurements listed in this test report acc. to CISPR 16 - 4 „Specification for radio disturbance and immunity measuring apparatus and methods – Part 4: Uncertainty in EMC Measurements“ and is documented in the Shenzhen Most Technology Service Co., Ltd. quality system acc. to DIN EN ISO/IEC 17025. Furthermore, component and process variability of devices similar to that tested may result in additional deviation. The manufacturer has the sole responsibility of continued compliance of the device.

Hereafter the best measurement capability for Shenzhen Most Technology Service Co., Ltd. is reported:

Test	Range	Measurement Uncertainty	Notes
Radiated Emission	30~1000MHz	4.10 dB	(1)
Radiated Emission	1~18GHz	4.32 dB	(1)
Radiated Emission	18-40GHz	5.54 dB	(1)
Conducted Disturbance	0.15~30MHz	3.12 dB	(1)

- (1) This uncertainty represents an expanded uncertainty expressed at approximately the 95% confidence level using a coverage factor of k=2.

4.5 Equipments Used during the Test

Item	Equipment	Manufacturer	Model No.	Serial No.	Firmware versions	Last Cal.
1.	L.I.S.N.	R&S	ENV216	100093	/	2024/03/15
2	Three-phase artificial power network	Schwarzback Mess	NNLK8129	8129178	/	2024/03/15
3.	Receiver	R&S	ESCI	100492	V3.0-10-2	2024/03/15
4	Receiver	R&S	ESPI	101202	V3.0-10-2	2024/03/15
5	Spectrum analyzer	Agilent	9020A	MT-E306	A14.16	2024/03/15
6	Bilong Antenna	Sunol Sciences	JB3	A121206	/	2024/08/14
7	Horn antenna	HF Antenna	HF Antenna	MT-E158	/	2024/03/15
8	Loop antenna	Beijing Daze	ZN30900B	/	/	2024/03/15
9	Horn antenna	R&S	OBH100400	26999002	/	2024/03/15
10	Wireless Communication Test Set	R&S	CMW500	/	CMW-BASE-3.7.21	2024/03/15
11	Spectrum analyzer	R&S	FSP	100019	V4.40 SP2	2024/03/15
12	High gain antenna	Schwarzbeck	LB-180400KF	MT-E389	/	2024/03/15
13	Preamplifier	Schwarzbeck	BBV 9743	MT-E390	/	2024/03/15
14	Pre-amplifier	EMCI	EMC051845S E	MT-E391	/	2024/03/15
15	Pre-amplifier	Agilent	83051A	MT-E392	/	2024/03/15
16	High pass filter unit	Tonscend	JS0806-F	MT-E393	/	2024/03/15
17	RF Cable(below1GHz)	Times	9kHz-1GHz	MT-E394	/	2024/03/15
18	RF Cable(above 1GHz)	Times	1-40G	MT-E395	/	2024/03/15
19	RF Cable (9KHz-40GHz)	Tonscend	170660	N/A	/	2024/03/15
20	Power meter	R&S	NRVS	100444	/	2024/03/15

Note: The Cal.Interval was one year.

5 TEST CONDITIONS AND RESULTS

5.1 AC Power Conducted Emission

TEST CONFIGURATION

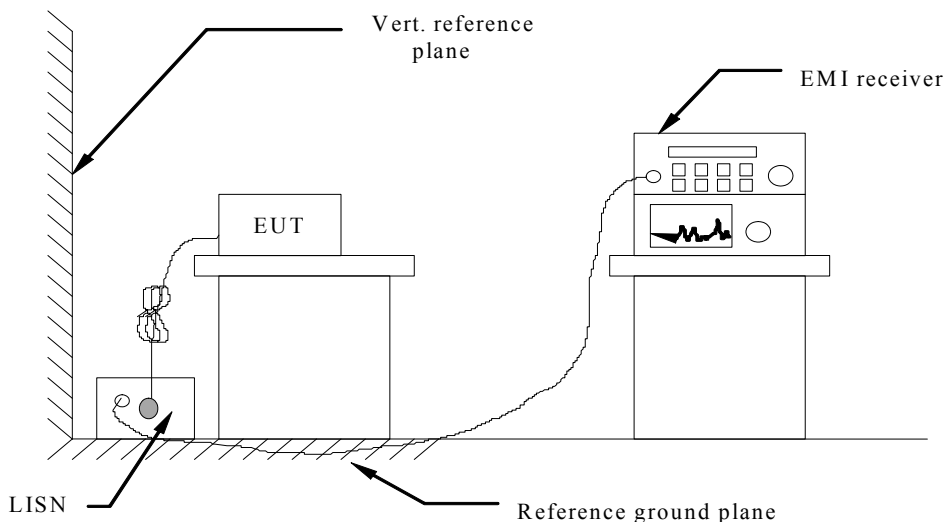

TEST PROCEDURE

- 1 The equipment was set up as per the test configuration to simulate typical actual usage per the user's manual. The EUT is a tabletop system, a wooden table with a height of 0.8 meters is used and is placed on the ground plane as per ANSI C63.10-2013.
- 2 Support equipment, if needed, was placed as per ANSI C63.10-2013
- 3 All I/O cables were positioned to simulate typical actual usage as per ANSI C63.10-2013
- 4 The EUT received DC 5V power, the adapter received AC120V/60Hz and AC 240V/60Hz power through a Line Impedance Stabilization Network (LISN) which supplied power source and was grounded to the ground plane.
- 5 All support equipments received AC power from a second LISN, if any.
- 6 The EUT test program was started. Emissions were measured on each current carrying line of the EUT using a spectrum Analyzer / Receiver connected to the LISN powering the EUT. The LISN has two monitoring points: Line 1 (Hot Side) and Line 2 (Neutral Side). Two scans were taken: one with Line 1 connected to Analyzer / Receiver and Line 2 connected to a 50 ohm load; the second scan had Line 1 connected to a 50 ohm load and Line 2 connected to the Analyzer / Receiver.
- 7 Analyzer / Receiver scanned from 150 KHz to 30MHz for emissions in each of the test modes.
- 8 During the above scans, the emissions were maximized by cable manipulation.

AC Power Conducted Emission Limit

For intentional device, according to § 15.207(a) AC Power Conducted Emission Limits is as following :

Frequency range (MHz)	Limit (dBuV)	
	Quasi-peak	Average
0.15-0.5	66 to 56*	56 to 46*
0.5-5	56	46
5-30	60	50

* Decreases with the logarithm of the frequency.

TEST RESULTS

Remark:

1. GFSK, $\pi/4$ DQPSK, 8DPSK were test at Low, Middle, and High channel; only the worst result of GFSK Middle Channel was reported as below:

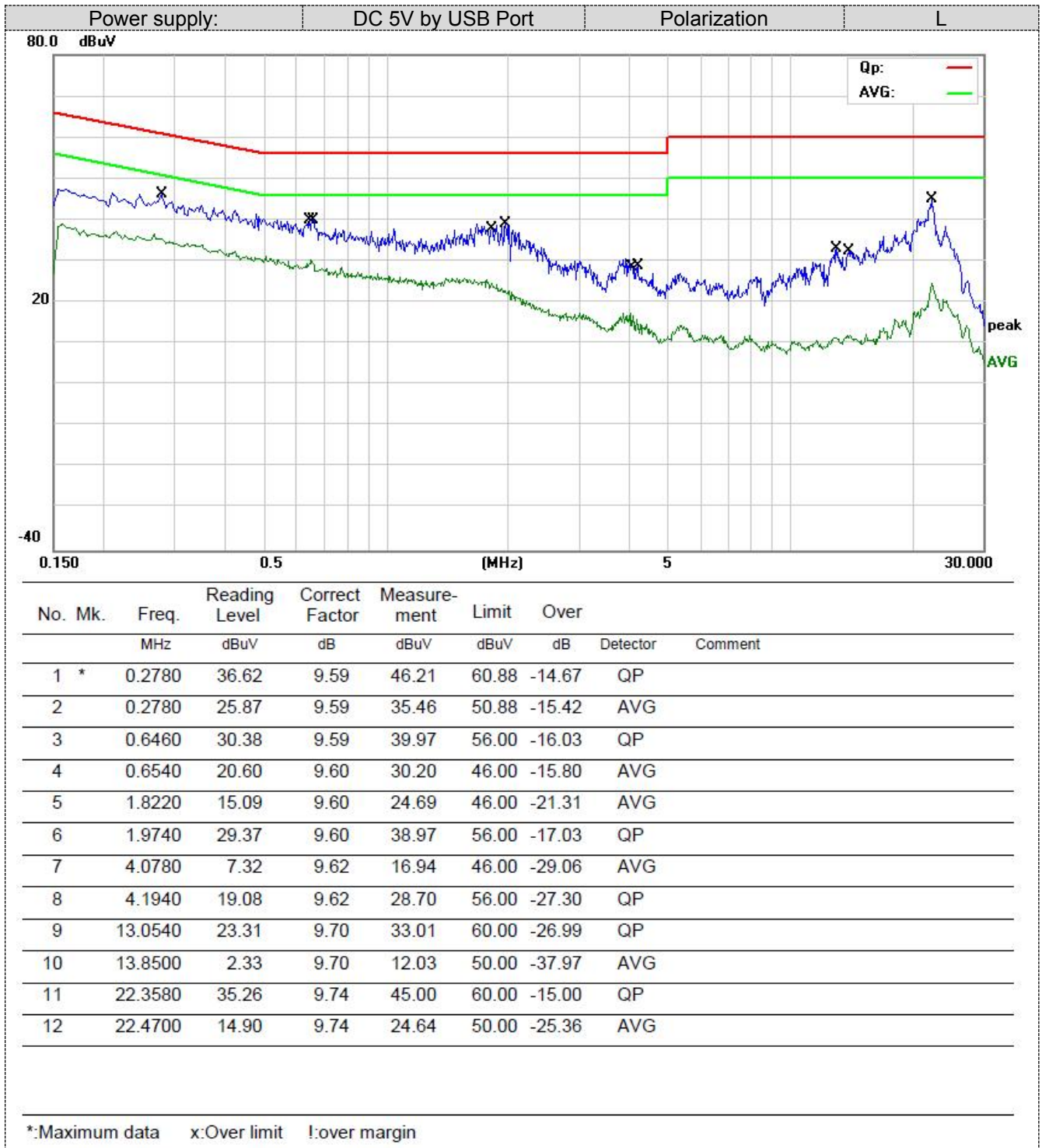

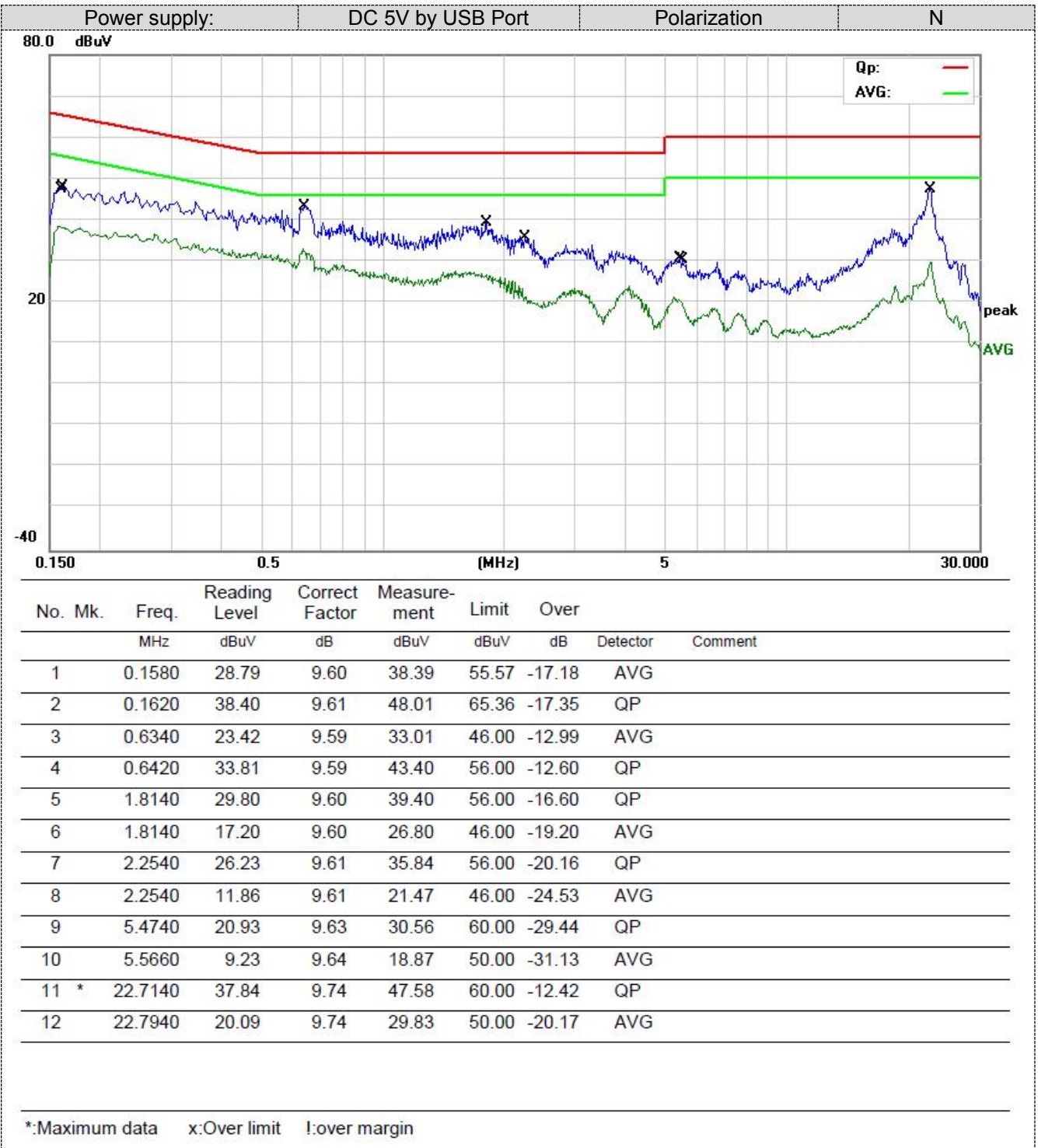

5.2 Radiated Emission

TEST CONFIGURATION

Frequency range 9 KHz – 30MHz

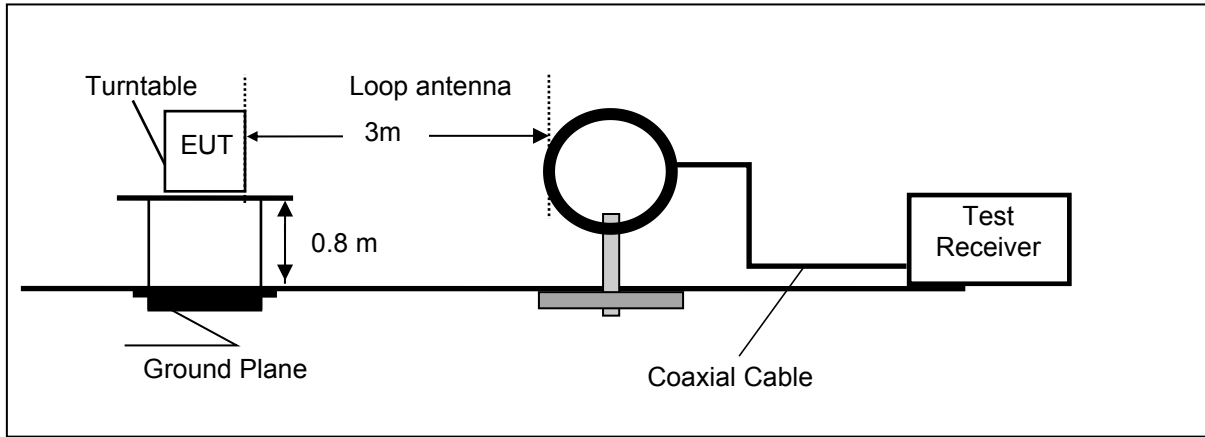

Frequency range 30MHz – 1000MHz

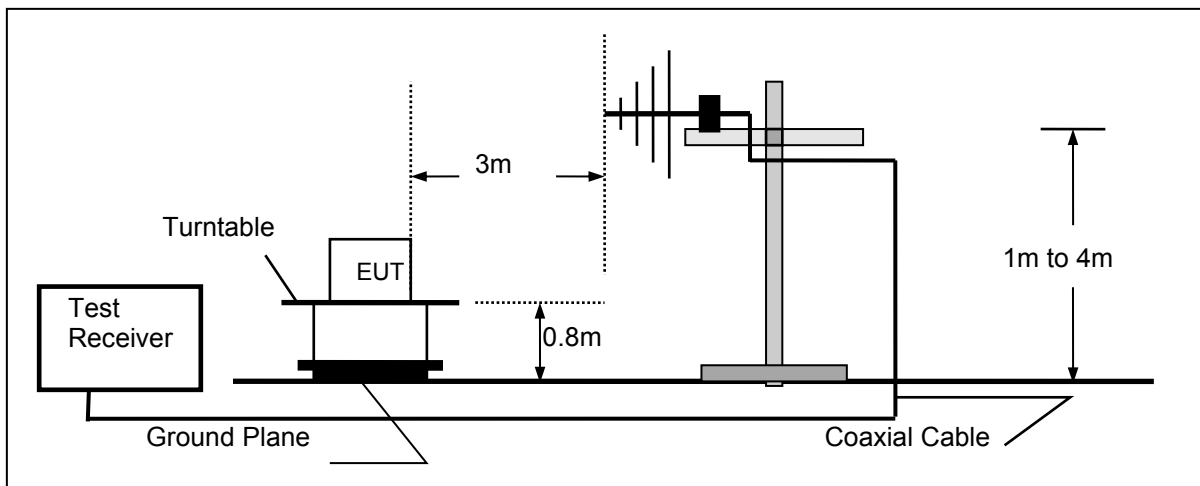

Frequency range above 1GHz-25GHz

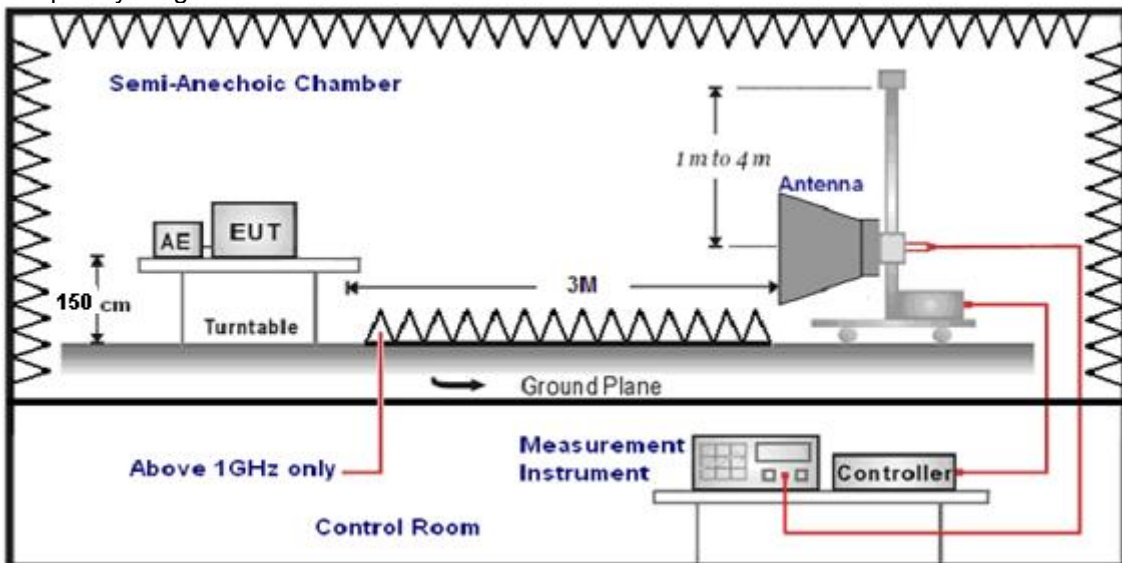

TEST PROCEDURE

1. The EUT was placed on a turn table which is 0.8m above ground plane when testing frequency range 9 KHz –1GHz;the EUT was placed on a turn table which is 1.5m above ground plane when testing frequency range 1GHz – 25GHz.
2. Maximum procedure was performed by raising the receiving antenna from 1m to 4m and rotating the turn table from 0° to 360° to acquire the highest emissions from EUT.
3. And also, each emission was to be maximized by changing the polarization of receiving antenna both horizontal and vertical.
4. Repeat above procedures until all frequency measurements have been completed.
5. Radiated emission test frequency band from 9KHz to 25GHz.
6. The distance between test antenna and EUT as following table states:

Test Frequency range	Test Antenna Type	Test Distance
9KHz-30MHz	Active Loop Antenna	3
30MHz-1GHz	Ultra-Broadband Antenna	3
1GHz-18GHz	Double Ridged Horn Antenna	3
18GHz-25GHz	Horn Antenna	1

7. Setting test receiver/spectrum as following table states:

Test Frequency range	Test Receiver/Spectrum Setting	Detector
9KHz-150KHz	RBW=200Hz/VBW=3KHz,Sweep time=Auto	QP
150KHz-30MHz	RBW=9KHz/VBW=100KHz,Sweep time=Auto	QP
30MHz-1GHz	RBW=120KHz/VBW=1000KHz,Sweep time=Auto	QP
1GHz-40GHz	Peak Value: RBW=1MHz/VBW=3MHz, Sweep time=Auto Average Value: RBW=1MHz/VBW=10Hz, Sweep time=Auto	Peak

Field Strength Calculation

The field strength is calculated by adding the Antenna Factor and Cable Factor and subtracting the Amplifier Gain and Duty Cycle Correction Factor(if any) from the measured reading. The basic equation with a sample calculation is as follows:

FS = RA + AF + CL - AG

Where FS = Field Strength	CL = Cable Attenuation Factor (Cable Loss)
RA = Reading Amplitude	AG = Amplifier Gain
AF = Antenna Factor	

Transd=AF +CL-AG

RADIATION LIMIT

For intentional device, according to § 15.209(a), the general requirement of field strength of radiated emission from intentional radiators at a distance of 3 meters shall not exceed the following table. According to § 15.247(d), in any 100kHz bandwidth outside the frequency band in which the EUT is operating, the radio frequency power that is produced by the intentional radiator shall be at least 20dB below that in the100kHz bandwidth within the band that contains the highest level of desired power.

The pre-test have done for the EUT in three axes and found the worst emission at position shown in test setup photos.

Frequency (MHz)	Distance (Meters)	Radiated (dBµV/m)	Radiated (µV/m)
0.009-0.49	3	20log(2400/F(KHz))+40log(300/3)	2400/F(KHz)
0.49-1.705	3	20log(24000/F(KHz))+ 40log(30/3)	24000/F(KHz)
1.705-30	3	20log(30)+ 40log(30/3)	30
30-88	3	40.0	100
88-216	3	43.5	150
216-960	3	46.0	200
Above 960	3	54.0	500

TEST RESULTS

Remark:

1. This test was performed with EUT in X, Y, Z position and the worse case was found when EUT in X position.
2. We measured Radiated Emission at GFSK, $\pi/4$ DQPSK and 8DPSK mode from 9 KHz to 25GHz and recorded worst case at GFSK DH5 mode.
3. For below 1GHz testing recorded worst at GFSK DH5 middle channel.
4. Radiated emission test from 9 KHz to 10th harmonic of fundamental was verified, and no emission found except system noise floor in 9 KHz to 30MHz and not recorded in this report.
5. Remark: Result=Reading value+Factor

For 30MHz-1GHz

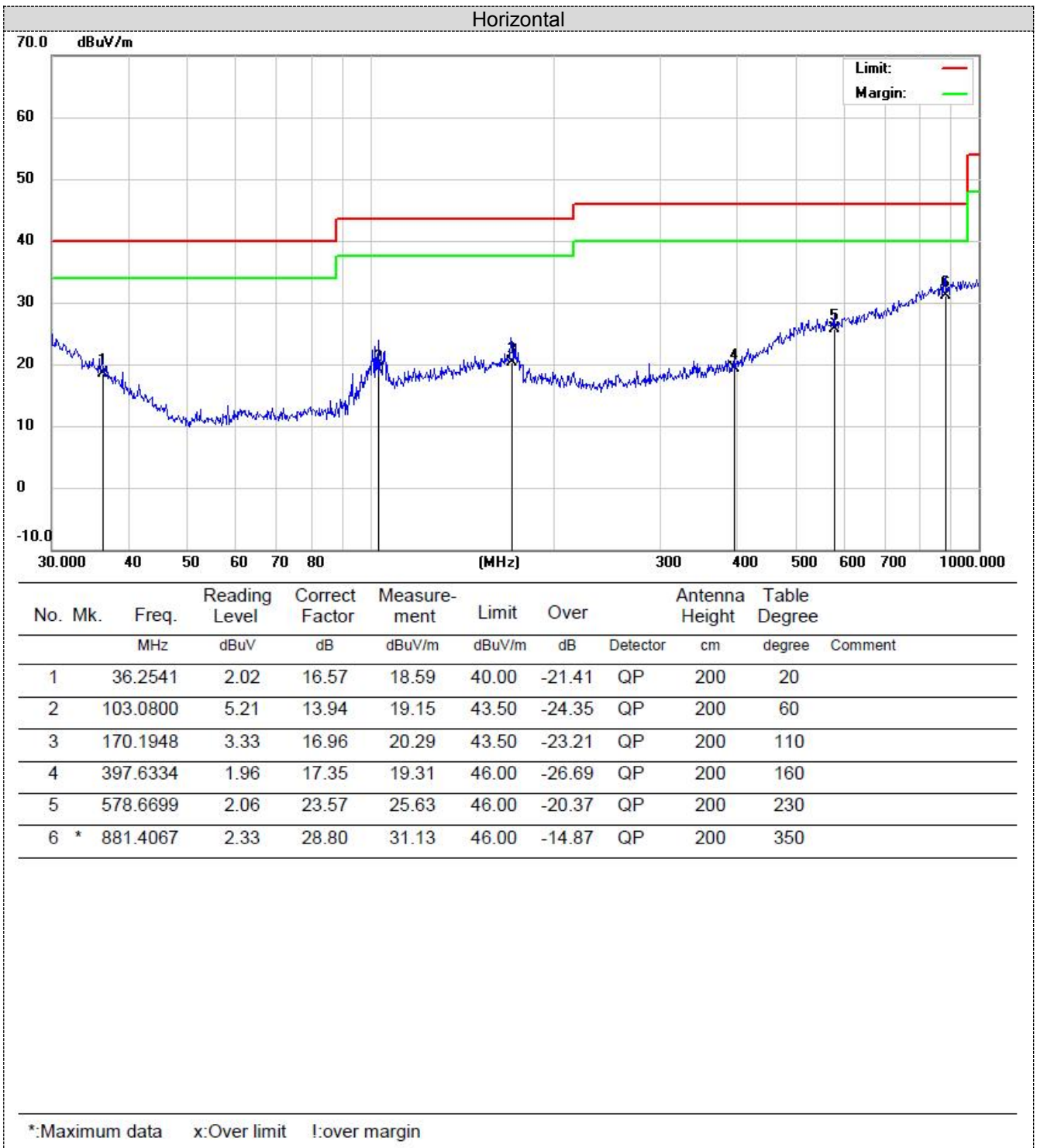

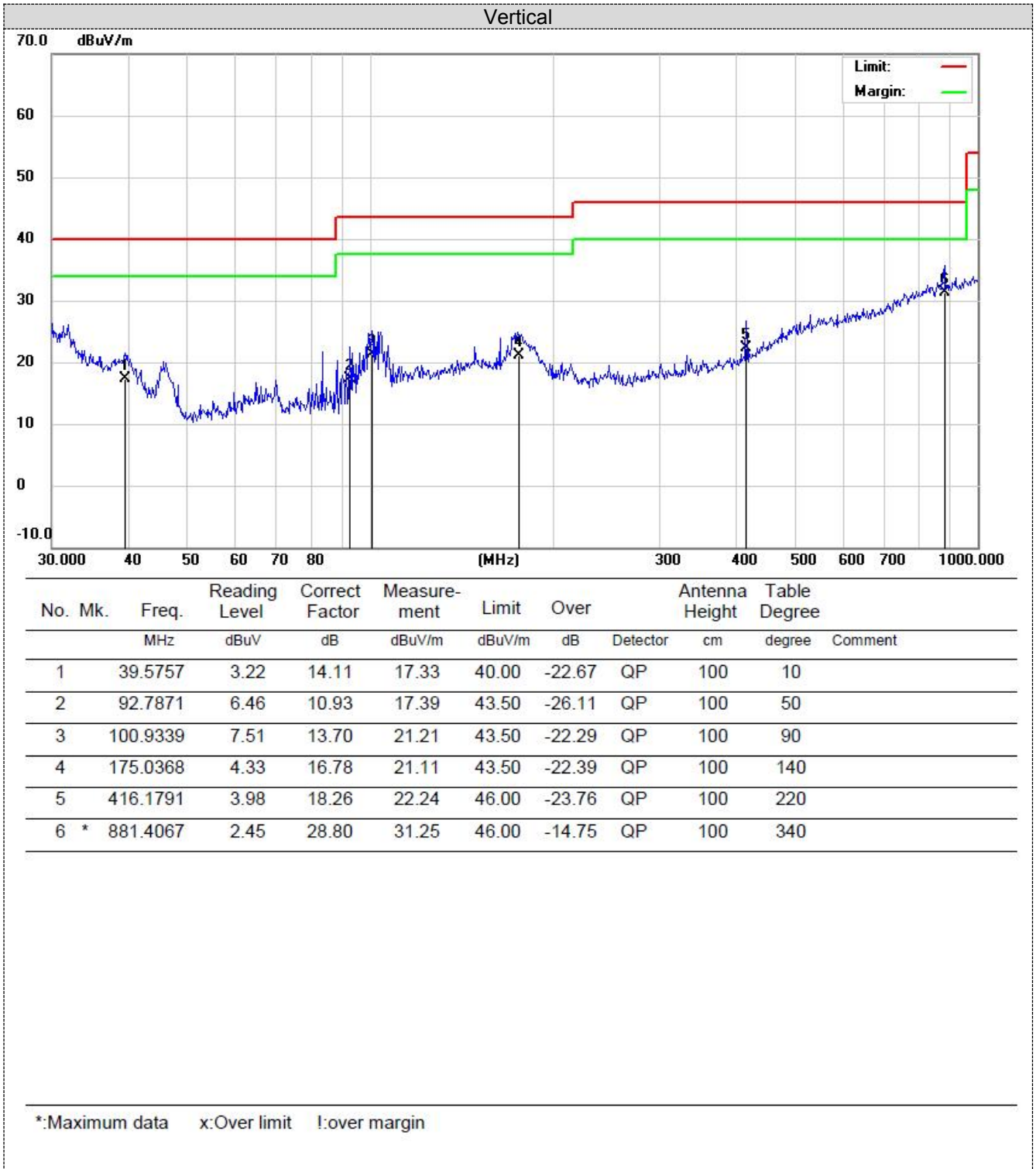

For 1GHz to 25GHz

Note: GFSK, $\pi/4$ DQPSK and 8DPSK all have been tested, only worse case GFSK is reported.

GFSK (above 1GHz)

Frequency(MHz):			2402		Polarity:		HORIZONTAL		
Frequency (MHz)	Emission Level (dBuV/m)		Limit (dBuV/m)	Margin (dB)	Raw Value (dBuV)	Antenna Factor (dB/m)	Cable Factor (dB)	Pre-amplifier (dB)	Correction Factor (dB/m)
4804	56.23	PK	74	17.77	54.33	31.42	6.98	36.5	1.9
4804	46.05	AV	54	7.95	44.15	31.42	6.98	36.5	1.9
7206	55.08	PK	74	18.92	44.48	37.03	8.87	35.3	10.6
7206	43.21	AV	54	10.79	32.61	37.03	8.87	35.3	10.6

Frequency(MHz):			2402		Polarity:		VERTICAL		
Frequency (MHz)	Emission Level (dBuV/m)		Limit (dBuV/m)	Margin (dB)	Raw Value (dBuV)	Antenna Factor (dB/m)	Cable Factor (dB)	Pre-amplifier (dB)	Correction Factor (dB/m)
4804	57.58	PK	74	16.42	55.68	31.42	6.98	36.5	1.9
4804	46.24	AV	54	7.76	44.34	31.42	6.98	36.5	1.9
7206	52.44	PK	74	21.56	41.84	37.03	8.87	35.3	10.6
7206	41.2	AV	54	12.8	30.6	37.03	8.87	35.3	10.6

Frequency(MHz):			2441		Polarity:		HORIZONTAL		
Frequency (MHz)	Emission Level (dBuV/m)		Limit (dBuV/m)	Margin (dB)	Raw Value (dBuV)	Antenna Factor (dB/m)	Cable Factor (dB)	Pre-amplifier (dB)	Correction Factor (dB/m)
4882	57.37	PK	74	16.63	55.31	30.98	7.58	36.5	2.06
4882	42.85	AV	54	11.15	40.79	30.98	7.58	36.5	2.06
7323	51.46	PK	74	22.54	40.54	37.66	8.56	35.3	10.92
7323	42.15	AV	54	11.85	31.23	37.66	8.56	35.3	10.92

Frequency(MHz):			2441		Polarity:		VERTICAL		
Frequency (MHz)	Emission Level (dBuV/m)		Limit (dBuV/m)	Margin (dB)	Raw Value (dBuV)	Antenna Factor (dB/m)	Cable Factor (dB)	Pre-amplifier (dB)	Correction Factor (dB/m)
4882	55.07	PK	74	18.93	53.01	30.98	7.58	36.5	2.06
4882	45.33	AV	54	8.67	43.27	30.98	7.58	36.5	2.06
7323	53.4	PK	74	20.6	42.48	37.66	8.56	35.3	10.92
7323	43.76	AV	54	10.24	32.84	37.66	8.56	35.3	10.92

Frequency(MHz):			2480		Polarity:		HORIZONTAL		
Frequency (MHz)	Emission Level (dBuV/m)		Limit (dBuV/m)	Margin (dB)	Raw Value (dBuV)	Antenna Factor (dB/m)	Cable Factor (dB)	Pre-amplifier (dB)	Correction Factor (dB/m)
4960	54.62	PK	74	19.38	51.55	31.47	7.8	36.2	3.07
4960	47.61	AV	54	6.39	44.54	31.47	7.8	36.2	3.07
7440	55.58	PK	74	18.42	43.84	38.32	8.72	35.3	11.74
7440	42.01	AV	54	11.99	30.27	38.32	8.72	35.3	11.74

Frequency(MHz):			2480		Polarity:		VERTICAL		
Frequency (MHz)	Emission Level (dBuV/m)		Limit (dBuV/m)	Margin (dB)	Raw Value (dBuV)	Antenna Factor (dB/m)	Cable Factor (dB)	Pre-amplifier (dB)	Correction Factor (dB/m)
4960	56.38	PK	74	17.62	53.31	31.47	7.8	36.2	3.07
4960	46.01	AV	54	7.99	42.94	31.47	7.8	36.2	3.07
7440	53.89	PK	74	20.11	42.15	38.32	8.72	35.3	11.74
7440	43.28	AV	54	10.72	31.54	38.32	8.72	35.3	11.74

REMARKS:

1. Emission level (dBuV/m) =Raw Value (dBuV)+Correction Factor (dB/m)
2. Correction Factor (dB/m) = Antenna Factor (dB/m)+Cable Factor (dB)- Pre-amplifier

- 3. Margin value = Limit value- Emission level.
- 4. -- Mean the PK detector measured value is below average limit.
- 5. The other emission levels were very low against the limit.

Results of Band Edges Test (Radiated)

Note: GFSK, $\pi/4$ DQPSK and 8DPSK all have been tested, only worse case GFSK is reported.

GFSK

Frequency(MHz):			2402		Polarity:		HORIZONTAL		
Frequency (MHz)	Emission Level (dBuV/m)		Limit (dBuV/m)	Margin (dB)	Raw Value (dBuV)	Antenna Factor (dB/m)	Cable Factor (dB)	Pre-amplifier (dB)	Correction Factor (dB/m)
2390	57.84	PK	74	16.16	63.25	27.49	3.32	36.22	-5.41
2390	38.98	AV	54	15.02	44.39	27.49	3.32	36.22	-5.41
Frequency(MHz):			2402		Polarity:		VERTICAL		
Frequency (MHz)	Emission Level (dBuV/m)		Limit (dBuV/m)	Margin (dB)	Raw Value (dBuV)	Antenna Factor (dB/m)	Cable Factor (dB)	Pre-amplifier (dB)	Correction Factor (dB/m)
2390	55.43	PK	74	18.57	60.84	27.49	3.32	36.22	-5.41
2390	40.53	AV	54	13.47	45.94	27.49	3.32	36.22	-5.41
Frequency(MHz):			2480		Polarity:		HORIZONTAL		
Frequency (MHz)	Emission Level (dBuV/m)		Limit (dBuV/m)	Margin (dB)	Raw Value (dBuV)	Antenna Factor (dB/m)	Cable Factor (dB)	Pre-amplifier (dB)	Correction Factor (dB/m)
2483.5	58.74	PK	74	15.26	64.25	27.45	3.38	36.34	-5.51
2483.5	41.52	AV	54	12.48	47.03	27.45	3.38	36.34	-5.51
Frequency(MHz):			2480		Polarity:		VERTICAL		
Frequency (MHz)	Emission Level (dBuV/m)		Limit (dBuV/m)	Margin (dB)	Raw Value (dBuV)	Antenna Factor (dB/m)	Cable Factor (dB)	Pre-amplifier (dB)	Correction Factor (dB/m)
2483.5	57.12	PK	74	16.88	62.63	27.45	3.38	36.34	-5.51
2483.5	42.02	AV	54	11.98	47.53	27.45	3.38	36.34	-5.51

REMARKS:

- 1. Emission level (dBuV/m) =Raw Value (dBuV)+Correction Factor (dB/m)
- 2. Correction Factor (dB/m) = Antenna Factor (dB/m)+Cable Factor (dB)- Pre-amplifier
- 3. Margin value = Limit value- Emission level.
- 4. -- Mean the PK detector measured value is below average limit.

5.3 Maximum Peak Output Power

Limit

The Maximum Peak Output Power Measurement is 125mW (20.97).

Test Procedure

Remove the antenna from the EUT and then connect a low loss RF cable from the antenna port to the powersensor.

Test Configuration



Test Results

See Appendix IV

5.4 20dB Bandwidth

Limit

For frequency hopping systems operating in the 2400MHz-2483.5MHz no limit for 20dB bandwidth.

Test Procedure

The transmitter output was connected to the spectrum analyzer through an attenuator. The bandwidth of the fundamental frequency was measured by spectrum analyzer with 30 KHz RBW and 100 KHz VBW.

The 20dB bandwidth is defined as the total spectrum the power of which is higher than peak power minus 20dB.

Test Configuration



Test Results

See Appendix VI

5.5 Frequency Separation

LIMIT

According to 15.247(a)(1), frequency hopping systems shall have hopping channel carrier frequencies separated by minimum of 25KHz or the $\frac{2}{3} \times 20\text{dB}$ bandwidth of the hopping channel, whichever is greater.

TEST PROCEDURE

The transmitter output was connected to the spectrum analyzer through an attenuator. The bandwidth of the fundamental frequency was measured by spectrum analyzer with 100 KHz RBW and 300 KHz VBW.

TEST CONFIGURATION



TEST RESULTS

See Appendix VII

5.6 Number of hopping frequency

Limit

Frequency hopping systems in the 2400–2483.5 MHz band shall use at least 15 channels.

Test Procedure

The transmitter output was connected to the spectrum analyzer through an attenuator. Set spectrum analyzer start 2400MHz to 2483.5MHz with 100 KHz RBW and 300 KHz VBW.

Test Configuration



Test Results

See Appendix III

5.7 Time of Occupancy (Dwell Time)

Limit

The average time of occupancy on any channel shall not be greater than 0.4 seconds within a period of 0.4 seconds multiplied by the number of hopping channels employed.

Test Procedure

The transmitter output was connected to the spectrum analyzer through an attenuator. Set center frequency of spectrum analyzer=operating frequency with 1MHz RBW and 1MHz VBW, Span 0Hz.

Test Configuration

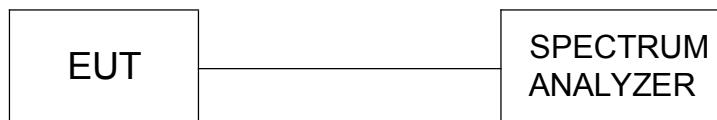

Test Results

See Appendix II

5.8 Spurious RF Conducted Emission

TEST CONFIGURATION



TEST PROCEDURE

The Spurious RF conducted emissions compliance of RF radiated emission should be measured by following the guidance in ANSI C63.10-2013 with respect to maximizing the emission by rotating the EUT, measuring the emission while the EUT is situated in three orthogonal planes (if appropriate), adjusting the measurement antenna height and polarization etc. Set RBW=100kHz and VBW= 300KHz to measure the peak field strength , and mwasure frequency range from 9KHz to 25GHz.

LIMIT

1. Below -20dB of the highest emission level in operating band.
2. Fall in the restricted bands listed in section 15.205. The maximum permitted average field strength is listed in section 15.209.

Test Results

See Appendix VIII

5.9 Pseudorandom Frequency Hopping Sequence

TEST APPLICABLE

For 47 CFR Part 15C section 15.247 (a) (1) requirement:

Frequency hopping systems shall have hopping channel carrier frequencies separated by a minimum of 25 kHz or the 20 dB bandwidth of the hop-ping channel, whichever is greater. Alternatively, frequency hopping systems operating in the 2400–2483.5 MHz band may have hopping channel carrier frequencies that are separated by 25 kHz or two-thirds of the 20 dB bandwidth of the hopping channel, whichever is greater, provided the systems operate with an output power no greater than 125 mW. The system shall hop to channel frequencies that are selected at the system hopping rate from a pseudo randomly ordered list of hopping frequencies. Each frequency must be used equally on the average by each transmitter. The system receivers shall have input bandwidths that match the hop-ping channel bandwidths of their corresponding transmitters and shall shift frequencies in synchronization with the transmitted signals.

EUT Pseudorandom Frequency Hopping Sequence Requirement

The pseudorandom frequency hopping sequence may be generated in a nine-stage shift register whose 5th and 9th stage outputs are added in a modulo-two addition stage. And the result is fed back to the input of the first stage. The sequence begins with the first one of 9 consecutive ones, for example: the shift register is initialized with nine ones.

- Number of shift register stages:9
- Length of pseudo-random sequence:2⁹-1=511 bits
- Longest sequence of zeros:8(non-inverted signal)

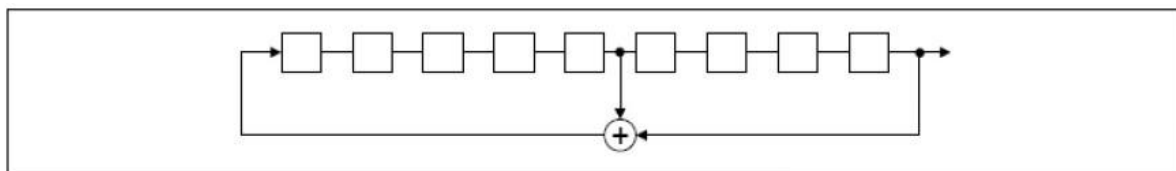

Linear Feedback Shift Register for Generation of the PRBS sequence

An example of pseudorandom frequency hopping sequence as follows:

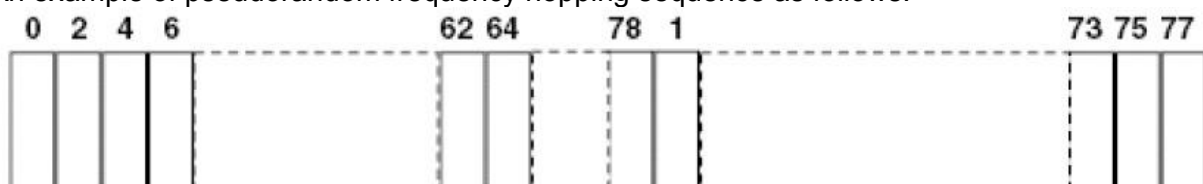

Each frequency used equally one the average by each transmitter.

The system receiver have input bandwidths that match the hopping channel bandwidths of their corresponding transmitter and shift frequencies in synchronization with the transmitted signals.

5.10 Antenna Requirement

Standard Applicable

For intentional device, according to FCC 47 CFR Section 15.203, an intentional radiator shall be designed to ensure that no antenna other than that furnished by the responsible party shall be used with the device.

And according to FCC 47 CFR Section 15.247 (c), if transmitting antennas of directional gain greater than 6dBi are used, the power shall be reduced by the amount in dB that the directional gain of the antenna exceeds 6dBi.

Refer to statement below for compliance

The manufacturer may design the unit so that the user can replace a broken antenna, but the use of a standard antenna jack or electrical connector is prohibited. Further, this requirement does not apply to intentional radiators that must be professionally installed.

Antenna Connected Construction

The directional gains of antenna used for transmitting is 2.06dBi, and the antenna is an Ceramic antenna connect to PCB board and no consideration of replacement. Please see EUT photo for details.

Results: Compliance.

6 Test Setup Photos of the EUT

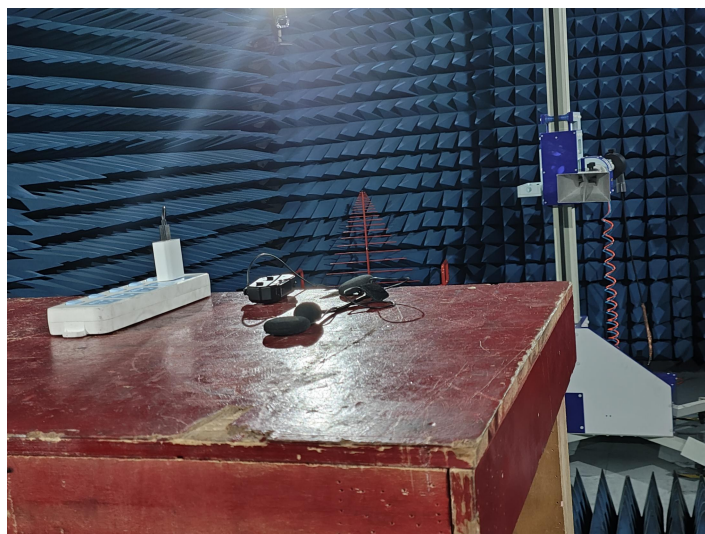
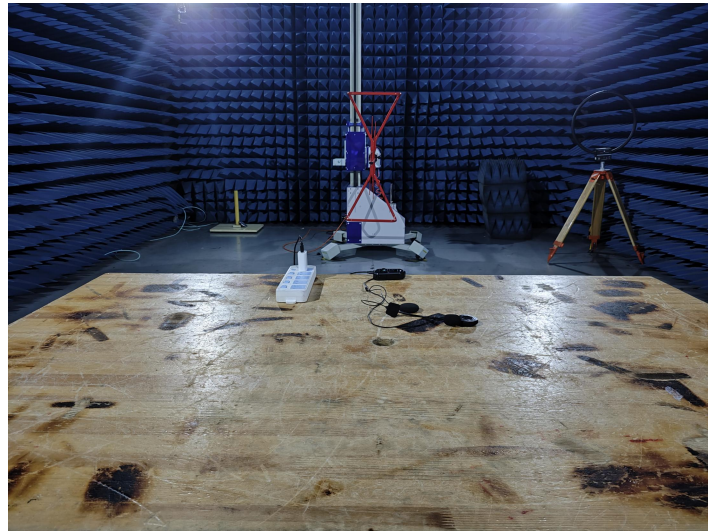

7 Photos of the EUT

See related photo report.

APPENDIX I.Duty Cycle

Test Result

Modulation	Packets	Channel	On Time (ms)	Period (ms)	Duty Cycle (%)	Duty Cycle (linear)	Duty Cycle Factor (dB)
GFSK	DH5	0	2.884	3.748	76.95	0.7695	1.1379
		39	2.886	3.748	77.00	0.7700	1.1351
		78	2.886	3.748	77.00	0.7700	1.1351
π/4DQPSK	2-DH5	0	2.890	3.748	77.11	0.7711	1.1289
		39	2.892	3.748	77.16	0.7716	1.1261
		78	2.892	3.748	77.16	0.7716	1.1261
8DPSK	3-DH5	0	2.894	3.748	77.21	0.7721	1.1233
		39	2.894	3.748	77.21	0.7721	1.1233
		78	2.894	3.748	77.21	0.7721	1.1233

Test Graphs

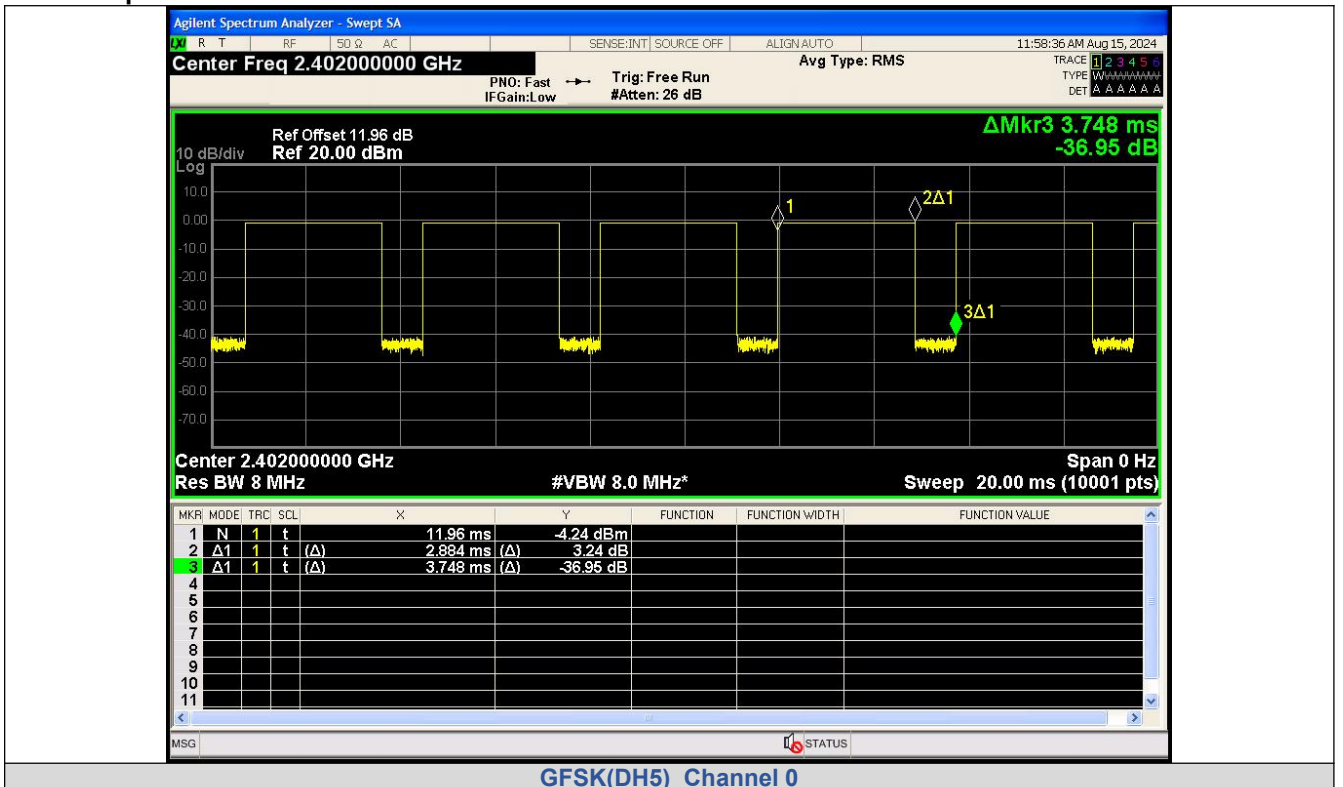

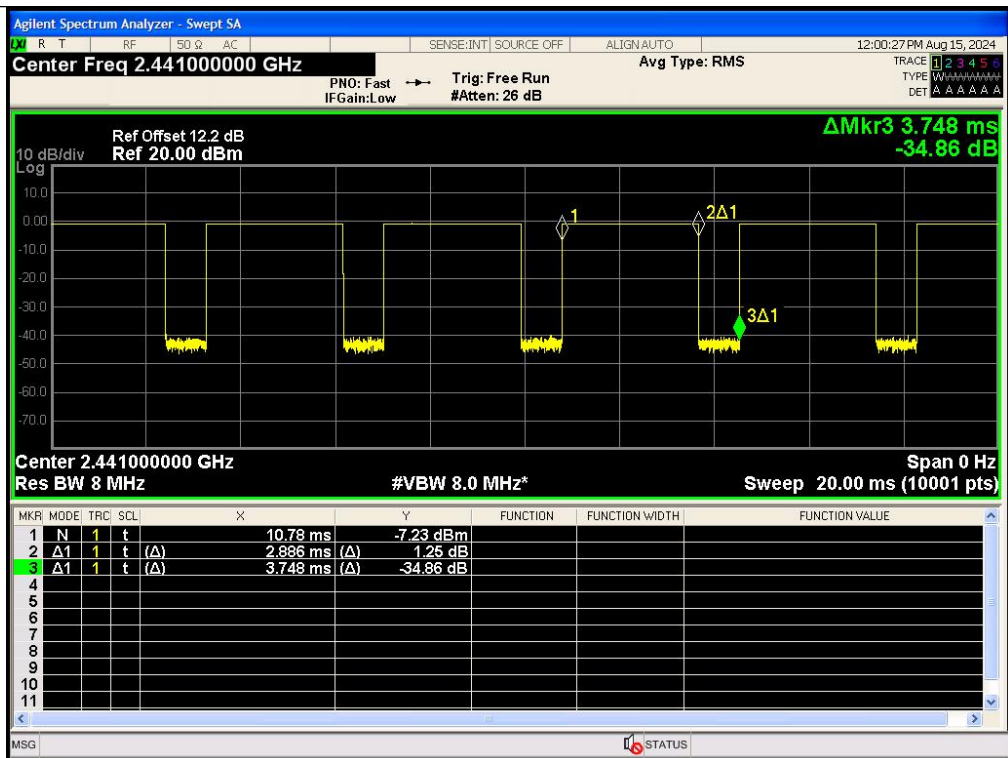

GFSK(DH5)_Channel 39

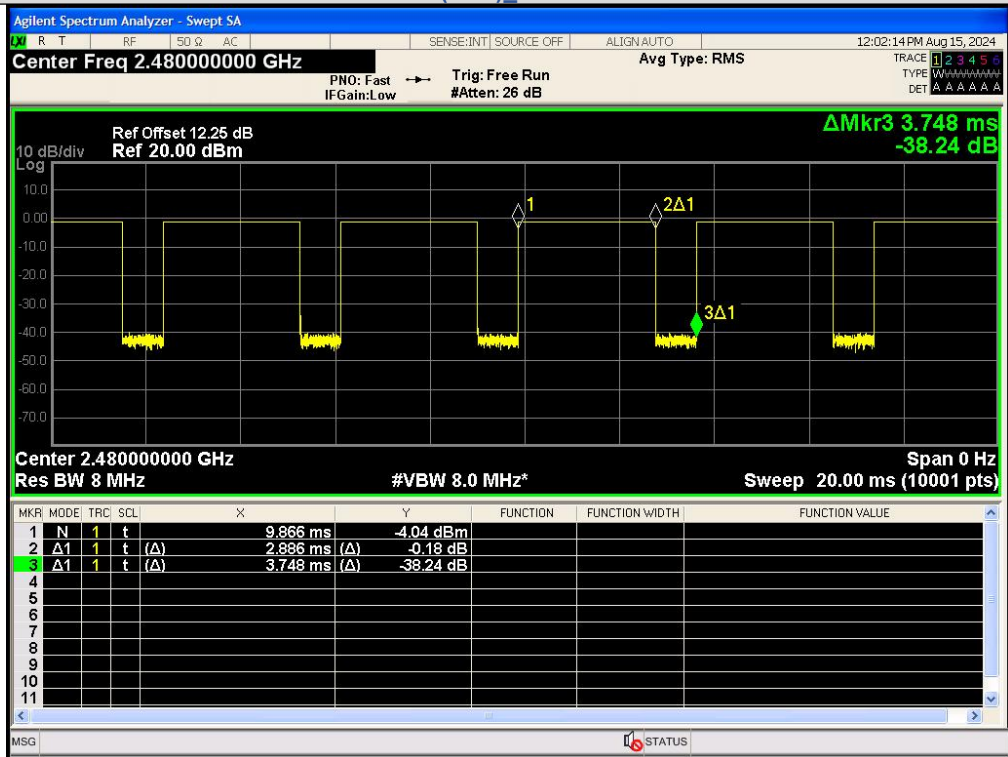

GFSK(DH5)_Channel 78

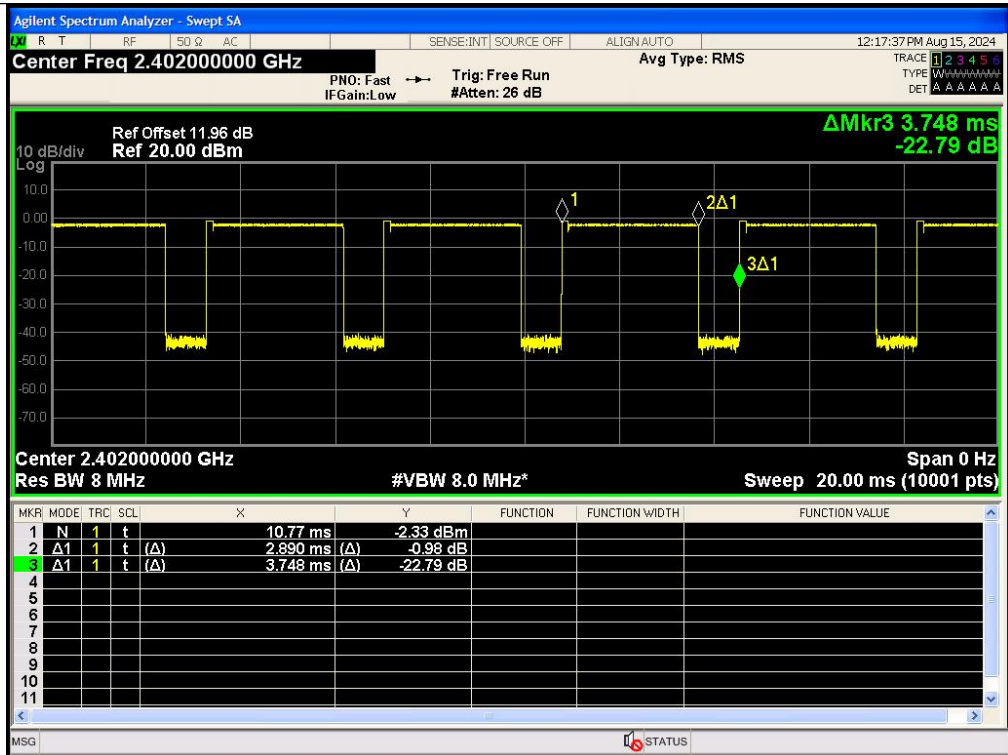

$\pi/4$ DQPSK(2-DH5)_Channel 0

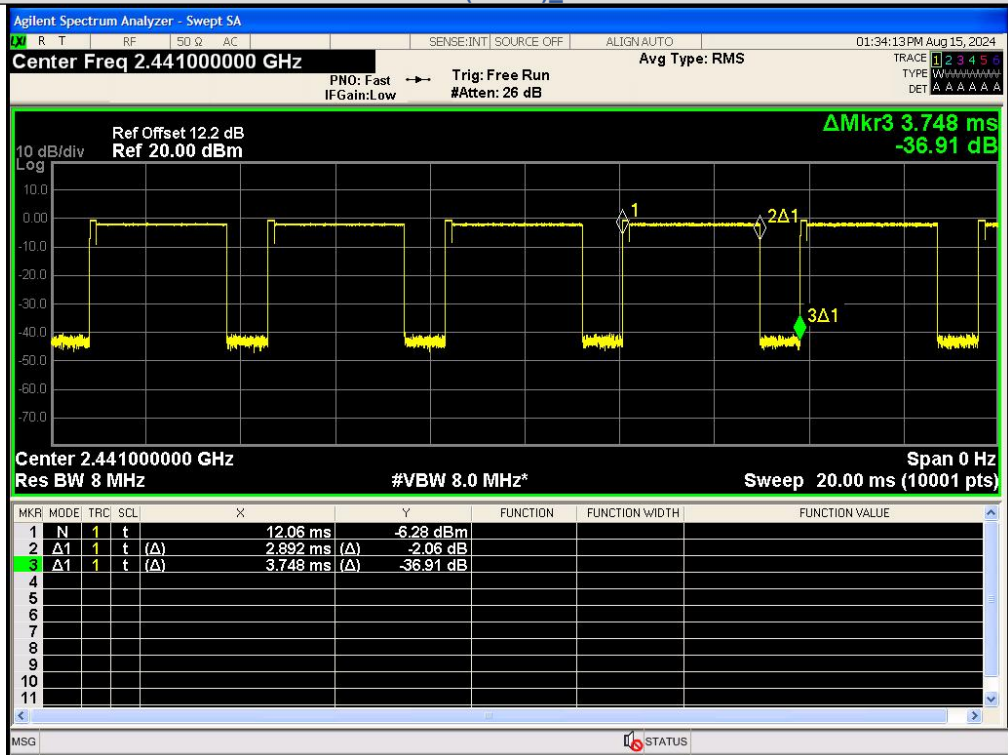

$\pi/4$ DQPSK(2-DH5)_Channel 39

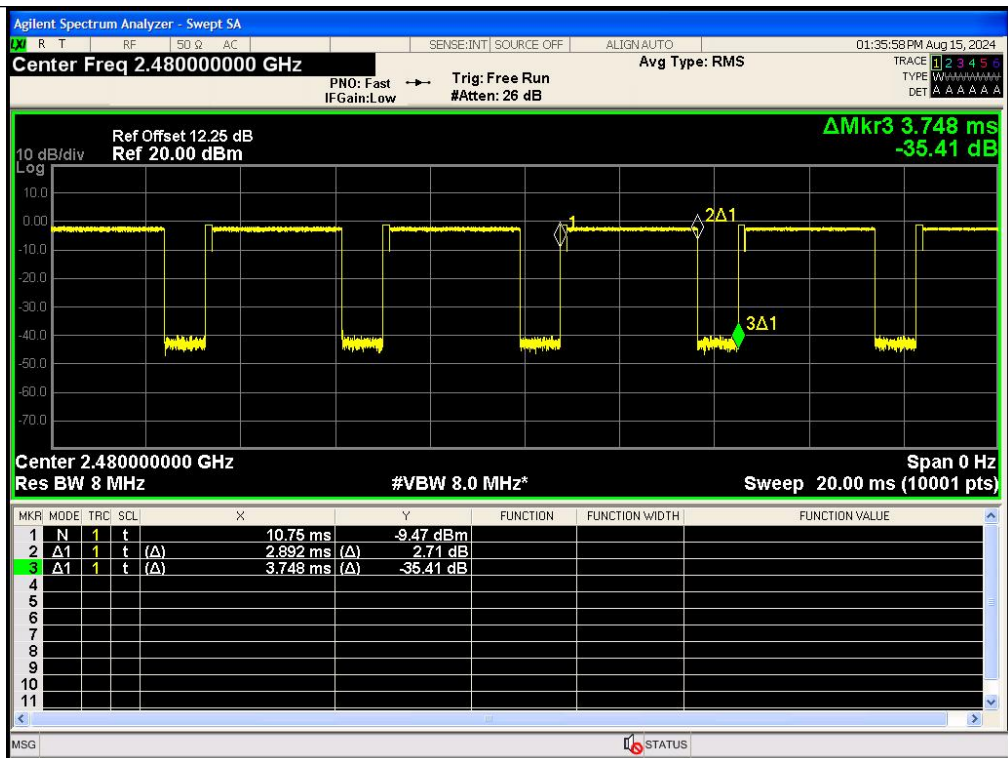

π /4DQPSK(2-DH5)_Channel 78

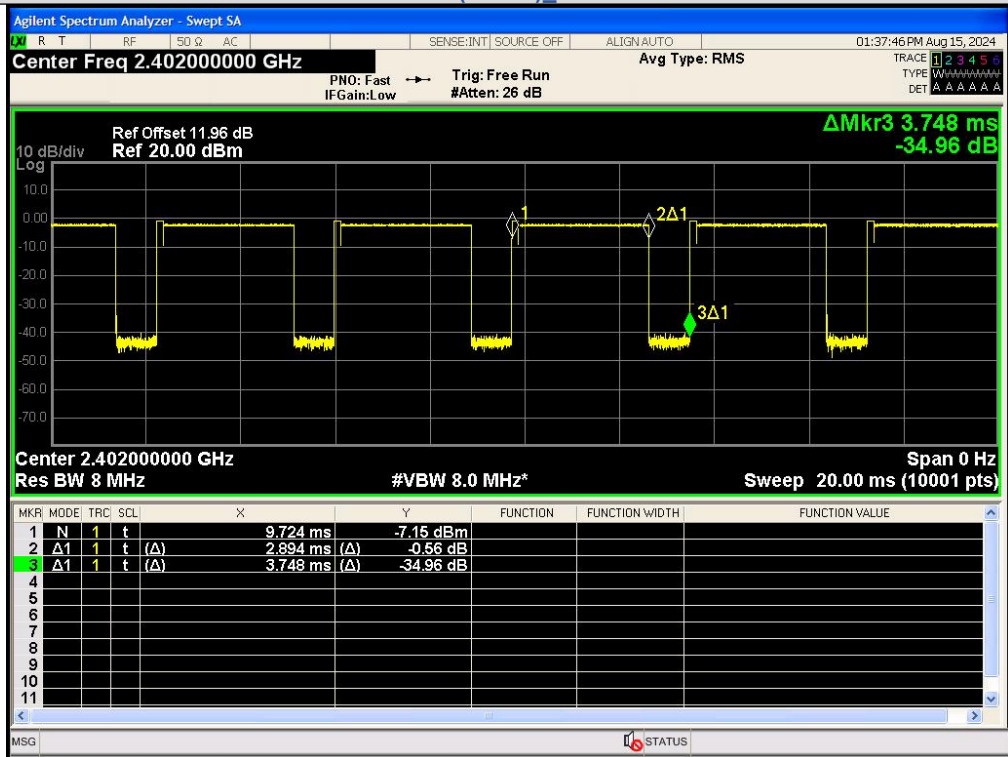

8DPSK(3-DH5)_Channel 0

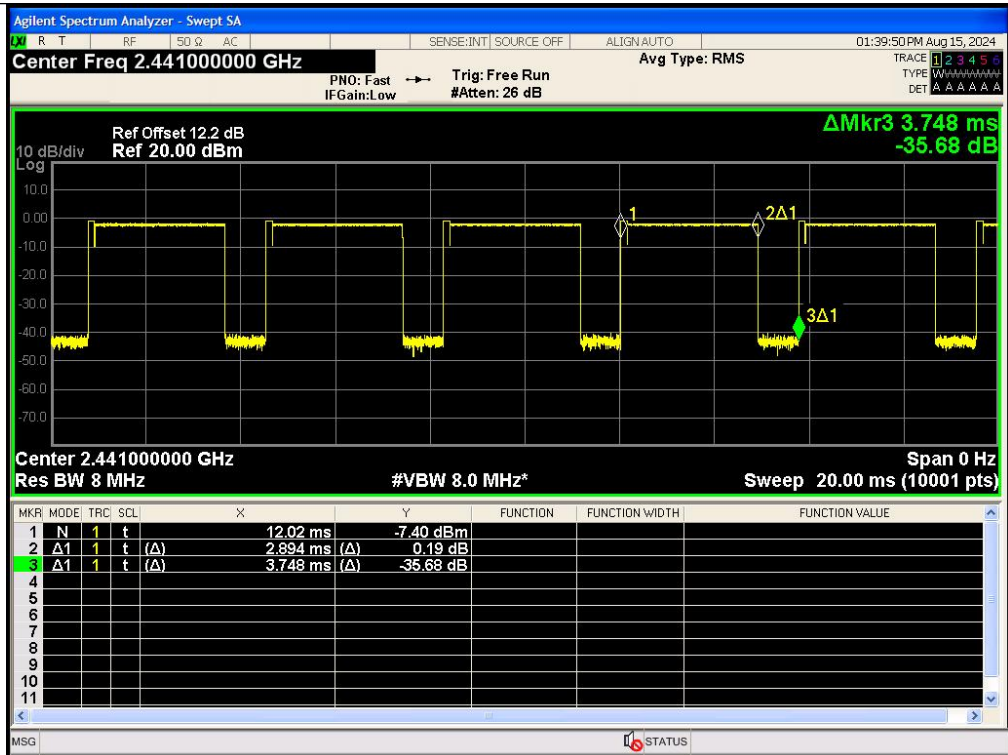

8DPSK(3-DH5)_Channel 39

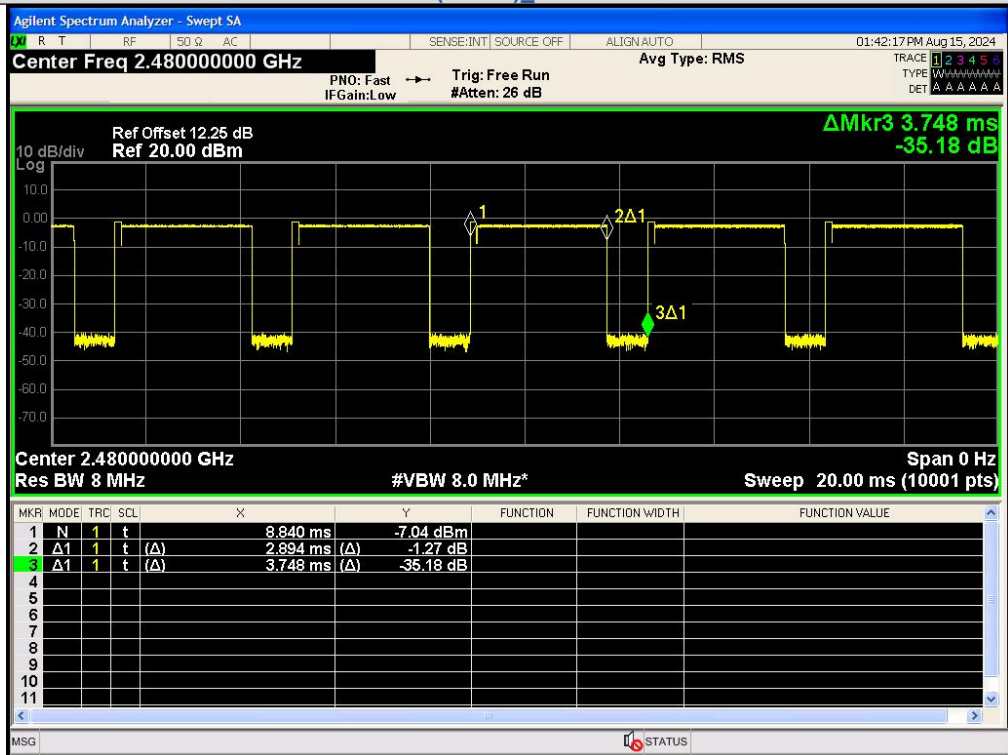

8DPSK(3-DH5)_Channel 78

APPENDIX II.Dwell Time Test Result

Modulation	Packet	Channel	Pulse Width (ms)	Number of Pulses in 31.6 seconds	Dwell Time (ms)	Limit (ms)	Result
GFSK	DH1	CH39 (2441MHz)	0.3828	319	122.11	< 400	PASS
	DH3		1.632	152	248.06		PASS
	DH5		2.880	111	319.68		PASS
π/4DQPSK	2-DH1		0.3900	317	123.63		PASS
	2-DH3		1.632	163	266.02		PASS
	2-DH5		2.896	109	315.66		PASS
8DPSK	3-DH1		0.3912	312	122.05		PASS
	3-DH3		1.632	163	266.02		PASS
	3-DH5		2.896	92	266.43		PASS

Test Graphs

<p>Agilent Spectrum Analyzer - Smppl SA Center Freq 2.441000000 GHz Ref Offset 12.2 dB Ref 27.20 dBm ΔMkr1 382.8 μs -2.78 dB Center 2.441000000 GHz Res BW 1.0 MHz #VBW 3.0 MHz Sweep 1.200 ms (1001 pts)</p>	<p>Agilent Spectrum Analyzer - Smppl SA Center Freq 2.441000000 GHz Ref Offset 12.2 dB Ref 15.00 dBm Center 2.441000000 GHz Res BW 1.0 MHz #VBW 3.0 MHz Sweep 31.60 s (40000 pts)</p>
<p style="text-align: center;">Pulse Width GFSK_DH1</p>	<p style="text-align: center;">Number of Pulses in 31.6 seconds GFSK_DH1</p>
<p>Agilent Spectrum Analyzer - Smppl SA Center Freq 2.441000000 GHz Ref Offset 12.2 dB Ref 27.20 dBm ΔMkr1 1.632 ms -0.08 dB Center 2.441000000 GHz Res BW 1.0 MHz #VBW 3.0 MHz Sweep 12.00 ms (1001 pts)</p>	<p>Agilent Spectrum Analyzer - Smppl SA Center Freq 2.441000000 GHz Ref Offset 12.2 dB Ref 15.00 dBm Center 2.441000000 GHz Res BW 1.0 MHz #VBW 3.0 MHz Sweep 31.60 s (20000 pts)</p>
<p style="text-align: center;">Pulse Width GFSK_DH3</p>	<p style="text-align: center;">Number of Pulses in 31.6 seconds GFSK_DH3</p>
<p>Agilent Spectrum Analyzer - Smppl SA Center Freq 2.441000000 GHz Ref Offset 12.2 dB Ref 27.20 dBm ΔMkr1 2.880 ms -0.08 dB Center 2.441000000 GHz Res BW 1.0 MHz #VBW 3.0 MHz Sweep 8.000 ms (1001 pts)</p>	<p>Agilent Spectrum Analyzer - Smppl SA Center Freq 2.441000000 GHz Ref Offset 12.2 dB Ref 15.00 dBm Center 2.441000000 GHz Res BW 1.0 MHz #VBW 3.0 MHz Sweep 31.60 s (40000 pts)</p>
<p style="text-align: center;">Pulse Width GFSK_DH5</p>	<p style="text-align: center;">Number of Pulses in 31.6 seconds GFSK_DH5</p>

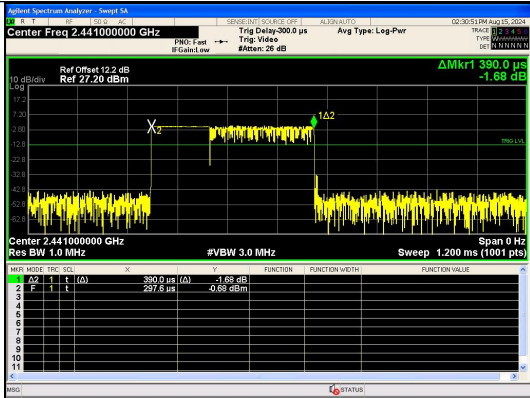

Pulse Width
 $\pi/4$ DQPSK 2-DH1

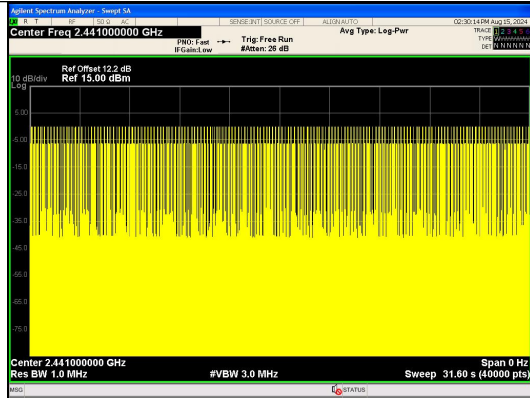

Number of Pulses in 31.6 seconds
 $\pi/4$ DQPSK 2-DH1

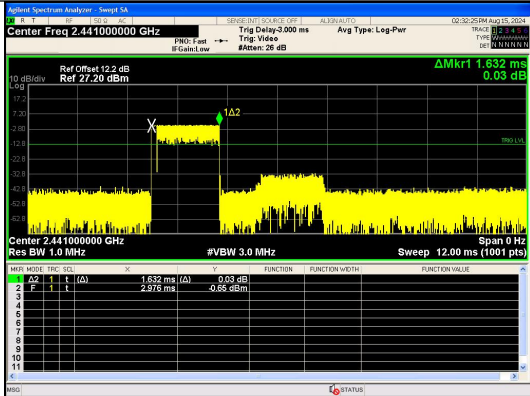

Pulse Width
 $\pi/4$ DQPSK 2-DH3

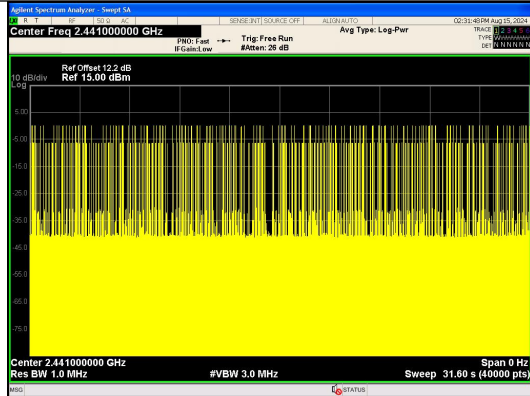

Number of Pulses in 31.6 seconds
 $\pi/4$ DQPSK 2-DH3

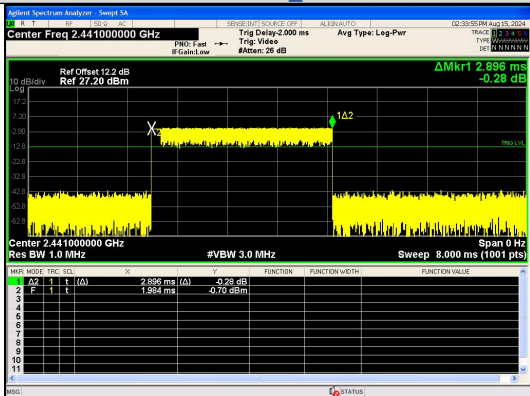

Pulse Width
 $\pi/4$ DQPSK 2-DH5

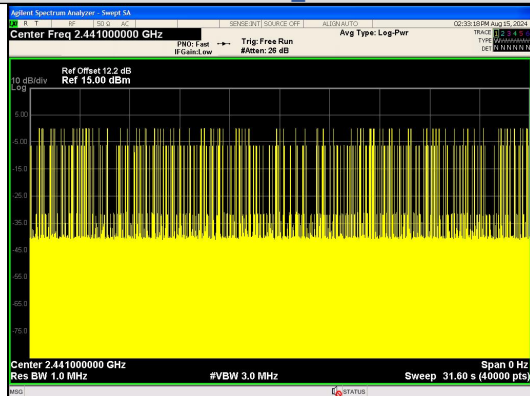

Number of Pulses in 31.6 seconds
 $\pi/4$ DQPSK 2-DH5

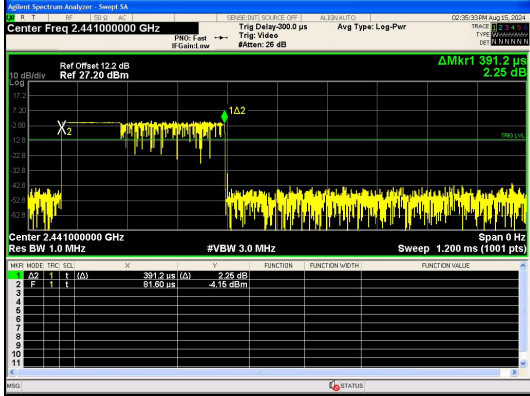

Pulse Width
 8DPSK 3-DH1

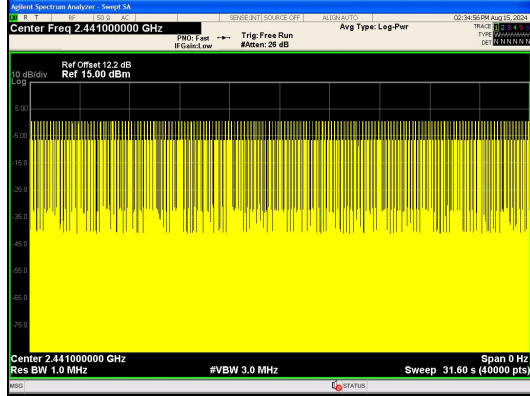

Number of Pulses in 31.6 seconds
 8DPSK 3-DH1