



**SGS-CSTC Standards Technical Services
(Shanghai) Co., Ltd.**

588 West Jindu Road, Xinqiao, Songjiang, 201612 Shanghai, China
 Telephone: +86 (0) 21 6191 5666
 Fax: +86 (0) 21 6191 5678
 ee.shanghai@sgs.com

Report No.: SHEM160900621801
 Page: 1 of 61

1 Cover Page

RF TEST REPORT

Application No.:	SHEM1609006218CR
Applicant:	Murata Manufacturing Co., Ltd
FCC ID:	VPYCMABZ
IC:	772C-CMABZ
Equipment Under Test (EUT): NOTE: The following sample(s) was/were submitted and identified by the client as	
Product Name:	LoRa module
Model No.(EUT):	CMWX1ZZABZ
Standards:	FCC PART 15 Subpart C: 2015 RSS-247 Issue 1 (May 2015) RSS-Gen Issue 4 (November 2014)
Date of Receipt:	2016-09-21
Date of Test:	2016-09-28 to 2016-12-16
Date of Issue:	2017-01-16
Test Result:	Pass*

*In the configuration tested, the EUT detailed in this report complied with the standards specified above.



Parlam Zhan
E&E Section Manager
SGS-CSTC (Shanghai) Co., Ltd.

The manufacturer should ensure that all products in series production are in conformity with the product sample detailed in this report. If the product in this report is used in any configuration other than that detailed in the report, the manufacturer must ensure the new system complies with all relevant standards.

The report must not be used by the client to claim product certification, approval, or endorsement by NVLAP, NIST, or any agency of the federal government. All test results in this report can be traceable to National or International Standards.

This document is issued by the Company subject to its General Conditions of Service printed overleaf, available on request or accessible at www.sgs.com/terms_and_conditions.htm and, for electronic format documents, subject to Terms and Conditions for Electronic Documents at www.sgs.com/terms_e-document.htm. Attention is drawn to the limitation of liability, indemnification and jurisdiction issues defined therein. Any holder of this document is advised that information contained hereon reflects the Company's findings at the time of its intervention only and within the limits of Client's instructions, if any. The Company's sole responsibility is to its Client and this document does not exonerate parties to a transaction from exercising all their rights and obligations under the transaction documents. This document cannot be reproduced except in full, without prior written approval of the Company. Any unauthorized alteration, forgery or falsification of the content or appearance of this document is unlawful and offenders may be prosecuted to the fullest extent of the law. Unless otherwise stated the results shown in this test report refer only to the sample(s) tested and such sample(s) are retained for 90 days only.

2 Test Summary

Test Item	FCC Requirement	IC Requirement	Test method	Result
Antenna Requirement	FCC Part 15, Subpart C Section 15.203/15.247 (c)	RSS-Gen Section 8.1.3	---	PASS
AC Power Line Conducted Emission	FCC Part 15, Subpart C Section 15.207	RSS-Gen Clause 8.8	ANSI C63.10 (2013) Section 6.2	N/A
Minimum 6dB Bandwidth	FCC Part 15, Subpart C Section 15.247 (a)(2)	RSS-247 Clause 5.2(1)	ANSI C63.10 (2013) Section 11.8.1	PASS
20dB Occupied Bandwidth	FCC Part 15, Subpart C Section 15.247 (a)(1)	RSS-247 Clause 5.1(1)	ANSI C63.10 (2013) Section 6.9.2	PASS
Maximum conducted (average) output power	FCC Part 15, Subpart C Section 15.247 (b)(3)	RSS-247 Clause 5.4(4)	ANSI C63.10 (2013) Section 11.9.2.2.2	PASS
Power Spectral Density of Digital Modulation System	FCC Part 15, Subpart C Section 15.247 (e)	RSS-247 Clause 5.2(2)	ANSI C63.10 (2013) Section 11.10.3	PASS
Carrier Frequencies Separation	FCC Part 15, Subpart C Section 15.247 (a)(1)	RSS-247 Clause 5.1(2))	ANSI C63.10 (2013) Section 7.8.2	PASS
Hopping Channel Number	FCC Part 15, Subpart C Section 15.247 (a)(1)	RSS-247 Clause 5.1(3)	ANSI C63.10 (2013) Section 7.8.3	PASS
Average Time of Occupancy for a Hybrid System	FCC Part 15, Subpart C Section 15.247 (f)	RSS-247 Clause 5.3	ANSI C63.10 (2013) Section 7.8.4	PASS
Power Spectral Density of a Hybrid System	FCC Part 15, Subpart C Section 15.247 (f)	RSS-247 Clause 5.3	ANSI C63.10 (2013) Section 11.10.3	PASS
RF Conducted Spurious Emissions and Band-edge	FCC Part 15, Subpart C Section 15.247(d)	RSS-247 Clause 5.5	ANSI C63.10 (2013) Section 11.11&11.13.3.2	PASS
Radiated Spurious Emissions and Band-edge	FCC Part 15, Subpart C Section 15.209&15.205	RSS-247 Clause 5.5	ANSI C63.10 (2013) Section 6.4&6.5&6.6&6.10	PASS
99% Occupied bandwidth	---	RSS-Gen Clause 6.6	RSS-Gen Issue 4 section 6.6	PASS



3 Contents

	Page
1 COVER PAGE	1
2 TEST SUMMARY	2
3 CONTENTS	3
4 GENERAL INFORMATION	4
4.1 CLIENT INFORMATION	4
4.2 GENERAL DESCRIPTION OF E.U.T.	4
4.3 TECHNICAL SPECIFICATIONS	4
4.4 TEST MODE	4
4.5 TEST CHANNEL	5
4.6 DESCRIPTION OF SUPPORT UNITS	5
4.7 TEST LOCATION	5
4.8 TEST FACILITY	6
4.9 MEASUREMENT UNCERTAINTY	7
5 EQUIPMENTS USED DURING TEST	8
6 TEST RESULTS	9
6.1 E.U.T. TEST CONDITIONS	9
6.2 ANTENNA REQUIREMENT	10
6.3 CONDUCTED EMISSIONS ON MAINS TERMINALS	11
6.4 6dB OCCUPIED BANDWIDTH.....	14
6.5 20dB OCCUPIED BANDWIDTH.....	17
6.6 MAXIMUM CONDUCTED (AVERAGE) OUTPUT POWER	20
6.7 POWER SPECTRAL DENSITY	23
6.8 CARRIER FREQUENCIES SEPARATED	27
6.9 HOPPING CHANNEL NUMBER	29
6.10 AVERAGE TIME OF OCCUPANCY	31
6.11 CONDUCTED SPURIOUS EMISSIONS AND BAND-EDGE.....	33
6.11.1 <i>Conducted spurious emission</i>	34
6.11.2 <i>Conducted Band-edge</i>	40
6.12 RADIATED SPURIOUS EMISSIONS AND BAND-EDGE.....	43
6.12.1 <i>Radiated Spurious Emissions</i>	46
6.12.2 <i>Radiated Band edge</i>	52
6.13 99% OCCUPIED BANDWIDTH.....	57
7 TEST SETUP PHOTOGRAPHS	61
8 EUT CONSTRUCTIONAL DETAILS	61

4 General Information

4.1 Client Information

Applicant:	Murata Manufacturing Co., Ltd
Address of Applicant:	10-1, Higashikotari 1-chome, Nagaokakyo-shi Kyoto 617-8555 Japan
Manufacturer:	Murata Manufacturing Co., Ltd
Address of Manufacturer:	10-1, Higashikotari 1-chome, Nagaokakyo-shi Kyoto 617-8555 Japan
Factory:	Shenzhen Murata Technology Co., Ltd
Address of Factory:	15 Cuijing Road, Shenzhen Grand Industrial Zone, PingShan New District, Shenzhen, Guangdong, China 518118

4.2 General Description of E.U.T.

Product Description:	Module product with 902-928MHz Transceiver
Brand Name:	Murata
Power Supply:	DC 3.3V

4.3 Technical Specifications

Operation Frequency:	125KHz Channel: 902.3-914.9MHz 500kHz Channel: 903-914.2MHz
Modulation Technique:	LoRa
Spread Factor (SF):	125KHz Channel: 7-10 500KHz Channel: 7-12
Number of Channel:	125KHz Channel: 64 channels 500KHz Channel: 8 channels
Channel Space:	125KHz Channel: 200KHz 500kHz Channel: 1.6MHz
Antenna Type:	Monopole Antenna
Antenna Gain:	1.04 dBi

4.4 Test Mode

Test Mode	Description of Test Mode
Engineering mode	Using test software was control EUT work in continuous transmitting mode or hopping mode.

4.5 Test Channel

	125KHz Channel			500KHz Channel		
	Channel	Frequency	SF	Channel	Frequency	SF
lowest channel	CH01	902.3MHz	10	CH65	903MHz	12
Middle channel	CH32	908.5MHz	10	CH68	907.8MHz	12
Highest channel	CH64	914.9MHz	10	CH72	914.2MHz	12

Remark: Preliminary tests were performed in all tests in different data rate and antenna configurations at lowest channel, the data rates of worse case as above were chosen for final test.

4.6 Description of Support Units

The EUT has been tested with support equipments as below.

Description	Manufacturer	Model No.	Supplied By
Laptop	Lenovo	ThinkPad X 100e	SGS
DC Power Supply	GW	GPS-1850D	SGS
Serial port adapter plate	/	EVK for TypeABZ module	Client

Parameter of DC Power Supply:

Power Supply:	Manufacturer:	GW	
	Model No.:	GPS-1850D	
	Rated Input:	AC 100~240V, 50/60Hz	
	Rated Output:	DC 3.3V	
	Cable length:	AC port:	3 wires 100cm
DC port:		2 wires 50 cm	

Software name	Manufacturer	Software Version	Supplied By
FSK-LoRa Module Test tool	/	1.0.7	Client

4.7 Test Location

All tests were performed at:

SGS-CSTC Standards Technical Services (Shanghai) Co., Ltd.
588 West Jindu Road, Xinqiao, Songjiang, 201612 Shanghai, China
Tel: +86 21 6191 5666
Fax: +86 21 6191 5678

4.8 Test Facility

The test facility is recognized, certified, or accredited by the following organizations:

- **CNAS (No. CNAS L0599)**

CNAS has accredited SGS-CSTC Standards Technical Services (Shanghai) Co., Ltd. to ISO/IEC 17025:2005 General Requirements for the Competence of Testing and Calibration Laboratories (CNAS-CL01 Accreditation Criteria for the Competence of Testing and Calibration Laboratories) for the competence in the field of testing.

- **FCC – Registration No.: 402683**

SGS-CSTC Standards Technical Services (Shanghai) Co., Ltd. has been registered and fully described in a report filed with the Federal Communications Commission (FCC). The acceptance letter from the FCC is maintained in our files. Registration No.: 402683.

- **Industry Canada (IC) – IC Assigned Code: 8617A**

The 3m Semi-anechoic chamber of SGS-CSTC Standards Technical Services (Shanghai) Co., Ltd. has been registered by Certification and Engineering Bureau of Industry Canada for radio equipment testing with Registration No.: 8617A-1.

- **VCCI (Member No.: 3061)**

The 3m Semi-anechoic chamber and Shielded Room of SGS-CSTC Standards Technical Services (Shanghai) Co., Ltd. has been registered in accordance with the Regulations for Voluntary Control Measures with Registration No.: R-3868, C-4336, T-2221, G-830 respectively.

4.9 Measurement Uncertainty

No.	Parameter	Measurement Uncertainty
1	Radio Frequency	$< \pm 1 \times 10^{-5}$
2	Total RF power, conducted	$< \pm 1.5$ dB
3	RF power density, conducted	$< \pm 3$ dB
4	Spurious emissions, conducted	$< \pm 3$ dB
5	All emissions, radiated	$< \pm 6$ dB (Below 1GHz) $< \pm 6$ dB (Above 1GHz)
6	Temperature	$< \pm 1^{\circ}\text{C}$
7	Humidity	$< \pm 5$ %
8	DC and low frequency voltages	$< \pm 3$ %

5 Equipments Used during Test

No.	Equipment	Manufacturer	Model No.	Inventory No.	Cal. Date	Cal. Due date
1	Power Meter	R&S	NRP	SHEM057-1	2016-01-14	2017-01-13
2	Power Meter Sensor	R&S	NRP-Z22	SHEM136-1	2016-08-12	2017-08-11
3	Spectrum Analyzer	R&S	FSP-30	SHEM002-1	2016-01-14	2017-01-13
4	EMI Receiver	R&S	ESU40	SHEM051-1	2016-01-16	2017-01-15
5	EMI Receiver	R&S	ESR7	SHEM162-1	2016-01-14	2017-01-13
6	LISN	SCHWARZBECK	NSLK8127	SHEM061-1	2016-01-14	2017-01-13
7	LISN	EMCO	3816/2	SHEM019-1	2016-01-14	2017-01-13
8	Loop Antenna (9kHz to 30MHz)	R&S	FMZB1519	SHEM135-1	2016-01-18	2017-01-17
9	Broadband Antenna (25MHz to 2GHz)	SCHWARZBECK	VULB9168	SHEM048-1	2016-01-16	2017-01-15
10	Broadband Antenna (25MHz to 3GHz)	R&S	HL562	SHEM010-1	2016-01-16	2017-01-15
11	Horn Antenna (1GHz to 18GHz)	R&S	HF906	SHEM009-1	2016-01-16	2017-01-15
12	Horn Antenna (1GHz to 18GHz)	SCHWARZBECK	BBHA9120D	SHEM050-1	2016-01-16	2017-01-15
13	Horn Antenna (14GHz to 40GHz)	SCHWARZBECK	BBHA 9170	SHEM049-1	2016-01-16	2017-01-15
14	Pre-amplifier (9kHz – 2GHz)	TESEQ	LNA6900	SHEM074-1	2016-01-14	2017-01-13
15	Pre-amplifier (1GHz – 26.5GHz)	SCHWARZBECK	F0118-G40-BZ4	SHEM049-2	2016-01-14	2017-01-13
16	Pre-amplifier (14GHz – 40GHz)	SCHWARZBECK	F1840-G35-BZ3	SHEM050-2	2016-01-14	2017-01-13
17	Low Pass Filter	Mini-Circuits	VLF-2500	SHEM114-1		
18	High Pass Filter	LORCH	5BRX-2400	SHEM155-1	/	/
19	High-low Temperature Cabinet	Suzhou Zhihe	TL-40	SHEM087-1	2016-08-15	2017-08-14
20	AC Power Stabilizer	WOCEN	6100	SHEM045-1	2016-01-14	2017-01-13
21	DC Power Supply	QJE	QJ30003SII	SHEM046-1	2016-01-14	2017-01-13
22	Signal Generator (Interferer)	R&S	SMR40	SHEM058-1	2016-08-12	2017-08-11
23	Signal Generator (Blocker)	R&S	SMJ100A	SHEM141-1	2016-01-14	2017-01-13
24	Splitter	ANRITSU CORP	MA1612A	SHEM159-1	/	/
25	Coupler	Mini-Circuits	803-S-1	SHEM113-1	/	/

6 Test Results

6.1 E.U.T. test conditions

Requirements: 15.31(e) For intentional radiators, measurements of the variation of the input power or the radiated signal level of the fundamental frequency component of the emission, as appropriate, shall be performed with the supply voltage varied between 85% and 115% of the nominal rated supply voltage. For battery operated equipment, the equipment tests shall be performed using a new battery.

Operating Environment:	Temperature:	20.0 -25.0 °C
	Humidity:	35-75 % RH
	Atmospheric Pressure:	99.2 -102 kPa

Test frequencies: According to the 15.31(m) Measurements on intentional radiators or receivers, other than TV broadcast receivers, shall be performed and, if required, reported for each band in which the device can be operated with the device operating at the number of frequencies in each band specified in the following table:

Frequency range over which device operates	Number of frequencies	Location in the range of operation
1 MHz or less	1	Middle
1 to 10 MHz	2	1 near top and 1 near bottom
More than 10 MHz	3	1 near top, 1 near middle and 1 near bottom

Pursuant to Part 15.31(c) For swept frequency equipment, measurements shall be made with the frequency sweep stopped at those frequencies chosen for the measurements to be reported.

EUT Configuration: The LoRa radio, as described in this report is separated into two sets of modes, which differ in their modulation bandwidths and operating channels. The 500kHz bandwidth channels form a traditional DTS modulation system. The 500kHz channels can have a spreading factor (SF) between 7 and 12, with a higher spreading factor corresponding to a lower data rate. Where data is taken in this report for 500KHz channel, unless state otherwise, the measurement were taken with a spreading factor of 12 as this constitutes the worst case scenario for emissions.

The 125kHz channels form a hybrid DTS and frequency hopping system, which meets part 15.247's requirements for a hybrid system. 125KHz channels can have a spreading factor between 7 and 10, with 10 spreading the worst case-emission.

Data that is laid out in this report reflects the two different types of channels. For each test that has a requirement for either The DTS (500KHz) or Hybrid(125KHz) system, this data is separated as such. Their respective limits need to be applied to the data, and any test that is only required one system is only performed on that system. Where test data is shown, the spreading factor and voltage have automatically been chosen for worst case emission

6.2 Antenna Requirement

Standard requirement:

An intentional radiator shall be designed to ensure that no antenna other than that furnished by the responsible party shall be used with the device. The use of a permanently attached antenna or of an antenna that uses a unique coupling to the intentional radiator, the manufacturer may design the unit so that a broken antenna can be replaced by the user, but the use of a standard antenna jack or electrical connector is prohibited

The conducted output power limit specified in paragraph (b) of this section is based on the use of antennas with directional gains that do not exceed 6 dBi. Except as shown in paragraph (c) of this section, if transmitting antennas of directional gain greater than 6 dBi are used, the conducted output power from the intentional radiator shall be reduced below the stated values in paragraphs (b)(1), (b)(2), and (b)(3) of this section, as appropriate, by the amount in dB that the directional gain of the antenna exceeds 6 dBi.

EUT Antenna:

The antenna is Monopole Antenna. The gain of the antenna is less than 1.04 dBi.

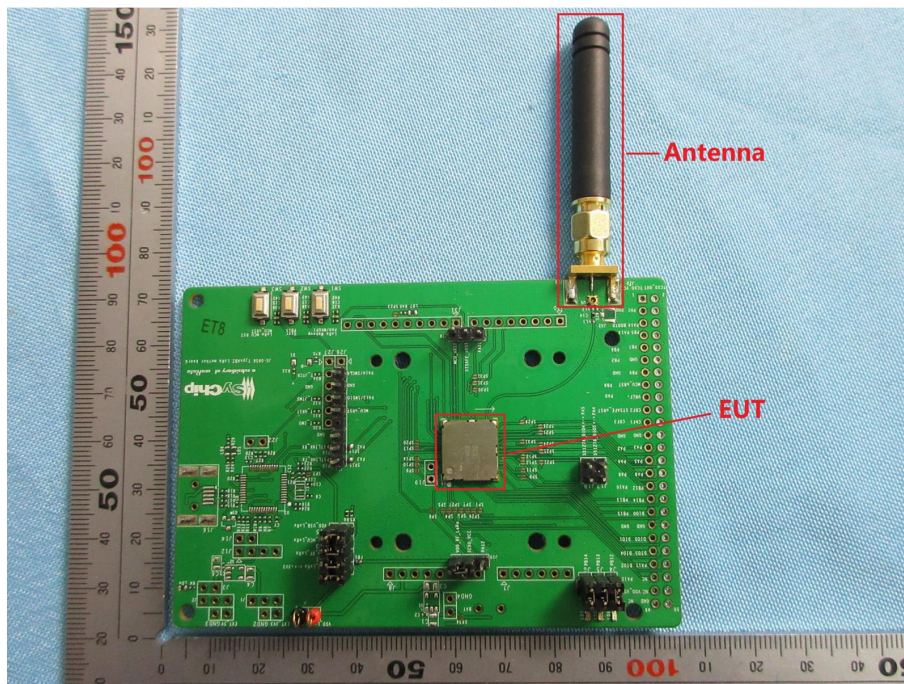

6.3 Conducted Emissions on Mains Terminals

Frequency Range: 150 KHz to 30 MHz

Limit:

Frequency range MHz	Class B Limits: dB (µV)	
	Quasi-peak	Average
0.15 to 0.50	66 to 56	56 to 46
0.50 to 5	56	46
5 to 30	60	50

Note1: The limit decreases linearly with the logarithm of the frequency in the range 0.15 MHz to 0.50MHz.

Note2: The lower limit is applicable at the transition frequency.

Test Setup:

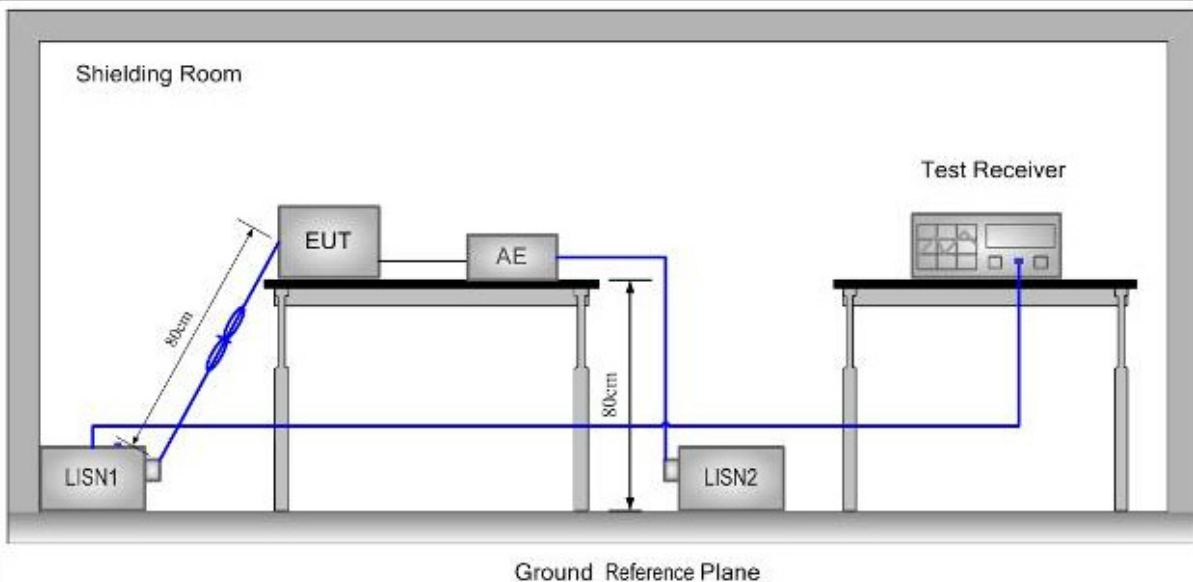

Test Procedure:

- 1) The mains terminal disturbance voltage was measured with the EUT in a shielded room.
- 2) The EUT was connected to AC power source through a LISN 1 (Line Impedance Stabilization Network) which provides 50Ω/50µH + 5Ω linear impedance. The power cables of all other units of the EUT were connected to a second LISN, which was bonded to the ground reference plane in the same way as the LISN for the unit being measured. A multiple socket outlet strip was used to connect multiple power cables to a single LISN provided the rating of the LISN was not exceeded
- 3) The tabletop EUT was placed upon a non-metallic table 0.8m above the ground reference plane. And for floor-standing arrangement, the EUT was placed on the horizontal ground reference plane, but separated from metallic contact with the ground reference plane by 0.1m of insulation.
- 4) The test was performed with a vertical ground reference plane. The rear of the EUT shall be 0.4 m from the vertical ground reference plane. The vertical ground reference plane was bonded to the horizontal ground reference plane. The LISN was placed 0.8 m from the boundary of the unit under test and bonded to a ground reference plane for LISN mounted on top of the ground reference plane. This distance was between the closest points of the LISN and the EUT. The mains lead of EUT excess 0.8m was folded back and forth parallel to the lead so as to form a horizontal bundle with a length between 0.3m and 0.4m. All other units of the EUT and associated equipment were at least 0.8 m from the LISN.

Remark: Pre-scan was performed with peak detected on all ports, Quasi-peak & average measurements were performed at the frequencies at which maximum peak emission level were detected. Pretest under all modes; choose the worst case mode (500KHz channel in 907.8MHz) record on the report. Please see the attached Quasi-peak and Average test results.

Test Result: Pass

Test Data:

Test Mode:	500KHz Channel	Test Channel:	907.8MHz
Test Port:	AC Live Line		

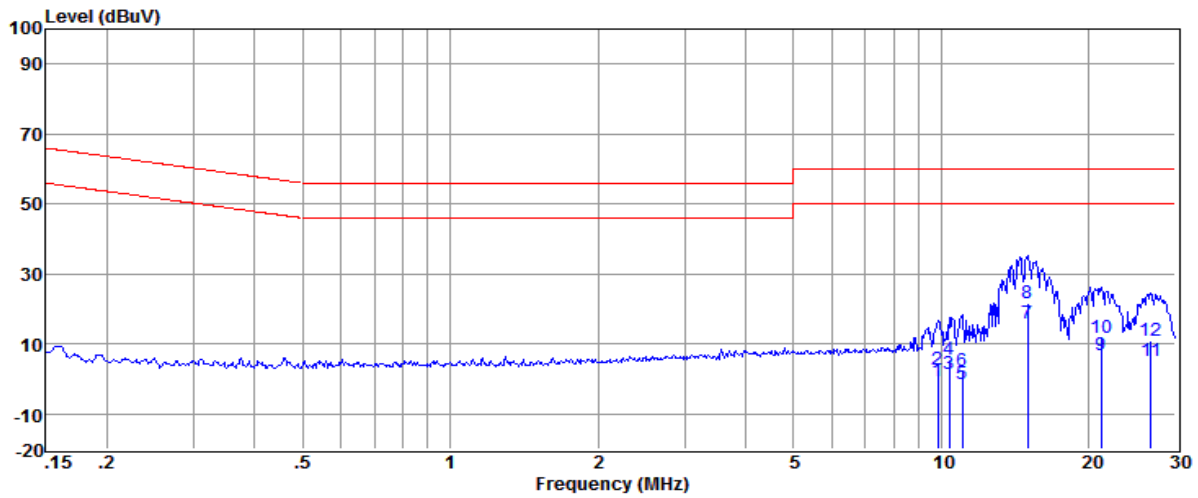

Item	Freq.	Read Level	LISN Factor	Cable Loss	Level	Limit Line	Over Limit	Detector
(Mark)	(MHz)	(dBμV)	(dB)	(dB)	(dBμV)	(dBμV)	(dB)	
1	9.861	-11.01	0.19	10.12	-0.70	50.00	-50.70	Average
2	9.861	-7.57	0.19	10.12	2.74	60.00	-57.26	QP
3	10.397	-8.99	0.19	10.15	1.35	50.00	-48.65	Average
4	10.397	-4.72	0.19	10.15	5.62	60.00	-54.38	QP
5	11.021	-11.71	0.20	10.21	-1.30	50.00	-51.30	Average
6	11.021	-8.09	0.20	10.21	2.32	60.00	-57.68	QP
7	14.986	5.19	0.22	10.28	15.69	50.00	-34.31	Average
8	14.986	11.07	0.22	10.28	21.57	60.00	-38.43	QP
9	21.147	-3.79	0.29	10.37	6.87	50.00	-43.13	Average
10	21.147	1.13	0.29	10.37	11.79	60.00	-48.21	QP
11	26.699	-5.57	0.44	10.46	5.33	50.00	-44.67	Average
12	26.699	0.21	0.44	10.46	11.11	60.00	-48.89	QP

Test Port: AC Neutral Line

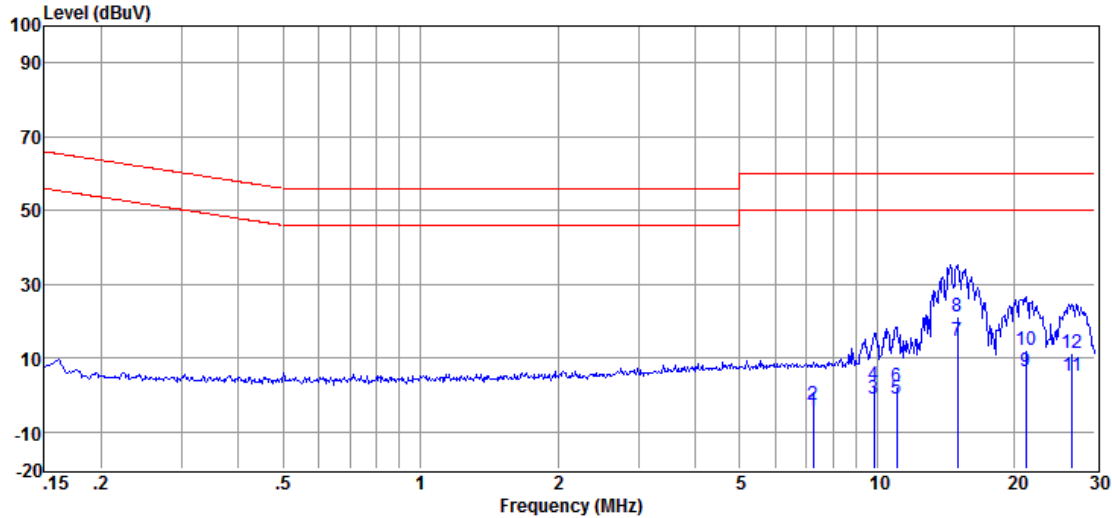

Item	Freq.	Read Level	LISN Factor	Cable Loss	Level	Limit Line	Over Limit	Detector
(Mark)	(MHz)	(dBμV)	(dB)	(dB)	(dBμV)	(dBμV)	(dB)	
1	7.252	-14.82	0.19	10.29	-4.34	50.00	-54.34	Average
2	7.252	-13.29	0.19	10.29	-2.81	60.00	-62.81	QP
3	9.861	-11.46	0.21	10.12	-1.13	50.00	-51.13	Average
4	9.861	-7.85	0.21	10.12	2.48	60.00	-57.52	QP
5	11.021	-11.64	0.22	10.21	-1.21	50.00	-51.21	Average
6	11.021	-8.21	0.22	10.21	2.22	60.00	-57.78	QP
7	14.986	4.28	0.26	10.28	14.82	50.00	-35.18	Average
8	14.986	10.83	0.26	10.28	21.37	60.00	-38.63	QP
9	21.147	-4.26	0.33	10.37	6.44	50.00	-43.56	Average
10	21.147	1.51	0.33	10.37	12.21	60.00	-47.79	QP
11	26.699	-5.84	0.46	10.46	5.08	50.00	-44.92	Average
12	26.699	0.35	0.46	10.46	11.27	60.00	-48.73	QP

Remark: Level = Read Level + LISN/ISN Factor + Cable Loss.

6.4 6dB Occupied Bandwidth

Test Configuration:

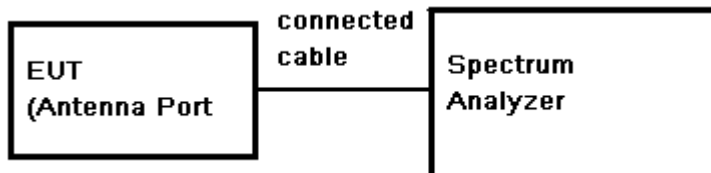

Test Procedure:

- 1) Place the EUT on the table and set it in transmitting mode.
- 2) Remove the antenna from the EUT and then connect a low loss RF cable from the antenna port to the spectrum analyzer.
- 3) Set the spectrum analyzer as RBW=100KHz, VBW≥3 x RBW, Detector=Peak, Trace mode= Max hold, Sweep=Auto couple.
- 4) Mark the peak frequency and -6dB (upper and lower) frequency.
- 5) Repeat above procedures until all frequency measured was complete.

Limit: ≥ 500 kHz

Test Result: Pass

Test Data:

Test Mode	Test Frequency (MHz)	6dB Bandwidth (KHz)	Limit (KHz)	Result
500kHz Channel	903	798.08	>500	Pass
	907.8	802.88		Pass
	914.2	788.46		Pass

Test plot as follows:

500KHz Channel	Test Channel: 903MHz
----------------	----------------------

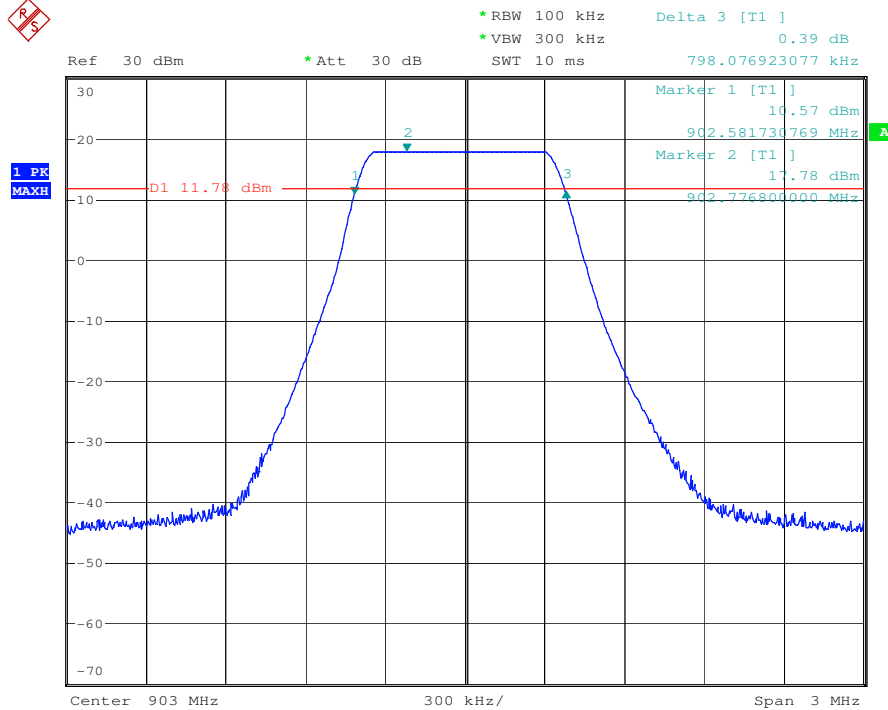

500KHz Channel	Test Channel: 907.8 MHz
----------------	-------------------------

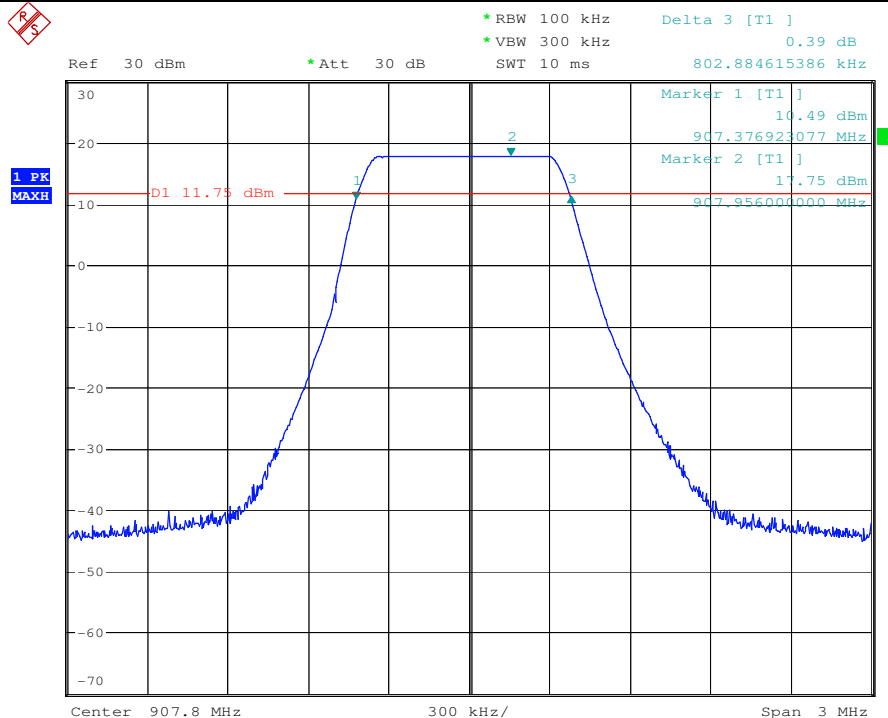

500KHz Channel

Test Channel:914.2 MHz

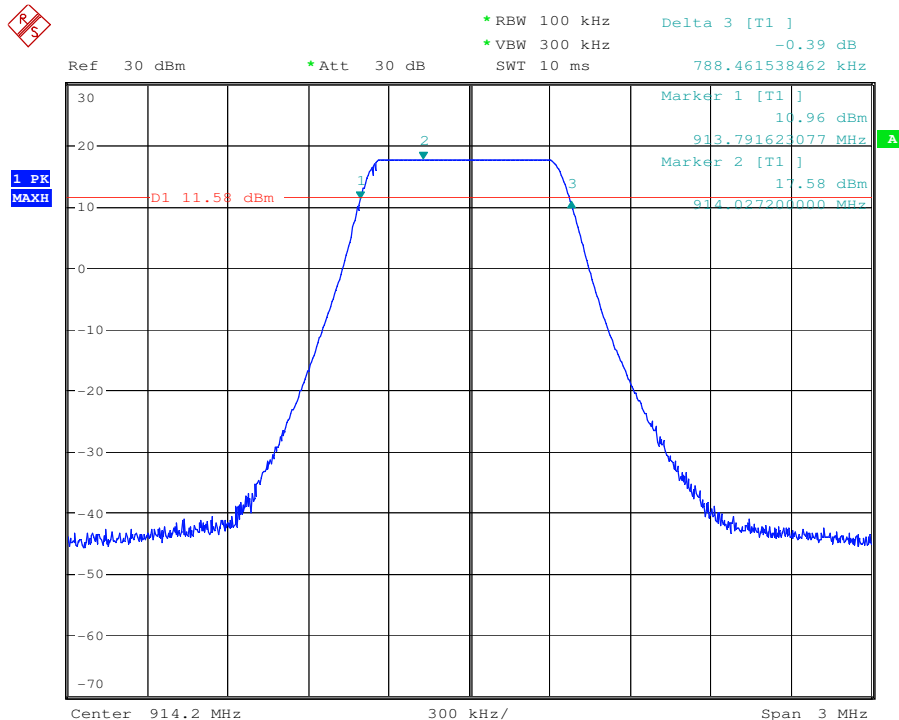

6.5 20dB Occupied Bandwidth

Test Configuration:

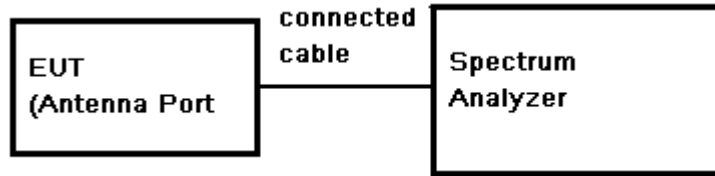

Test Procedure:

1. Remove the antenna from the EUT and then connect a low RF cable from the antenna port to the spectrum;
2. Set the spectrum analyzer: Span = approximately 1.5 to 5 times the OBW, centred on the hopping channel;
3. Set the spectrum analyzer: RBW \geq 1% to 5% of the OBW. VBW \geq 3 x RBW. Sweep = Auto; Detector = Peak. Trace = Max Hold.
4. Mark the peak frequency and -20dB points.

Test Date:

Test Mode	Test Frequency(MHz)	Bandwidth(KHz)
125KHz Channel	902.3	139.42
	908.5	140.22
	914.9	140.72

Test plot as follows:

125KHz Channel	Test channel: 902.3MHz
----------------	------------------------

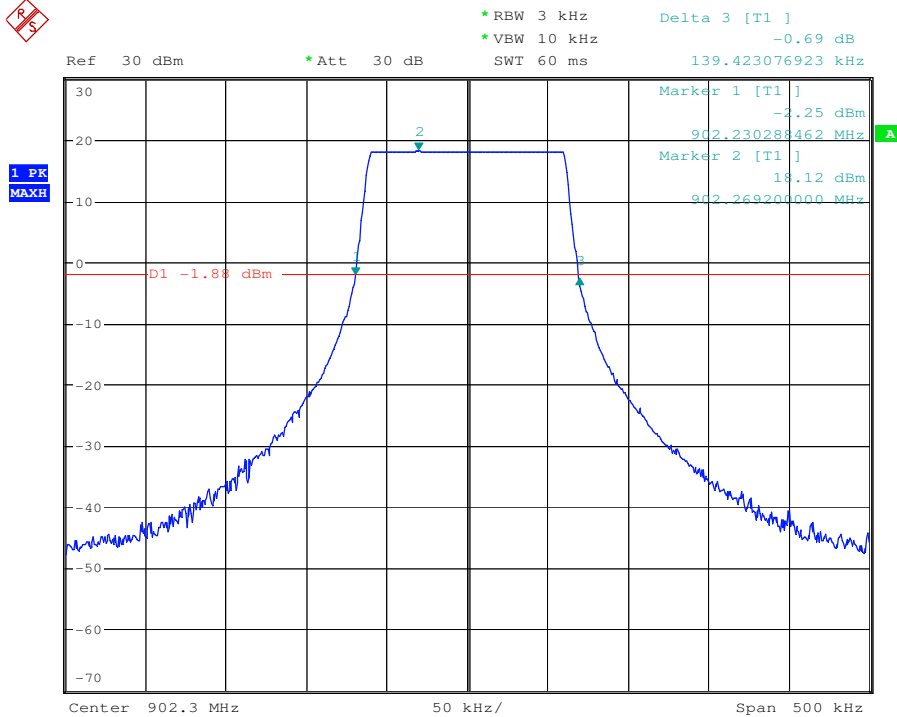

125KHz Channel	Test channel: 908.5MHz
----------------	------------------------

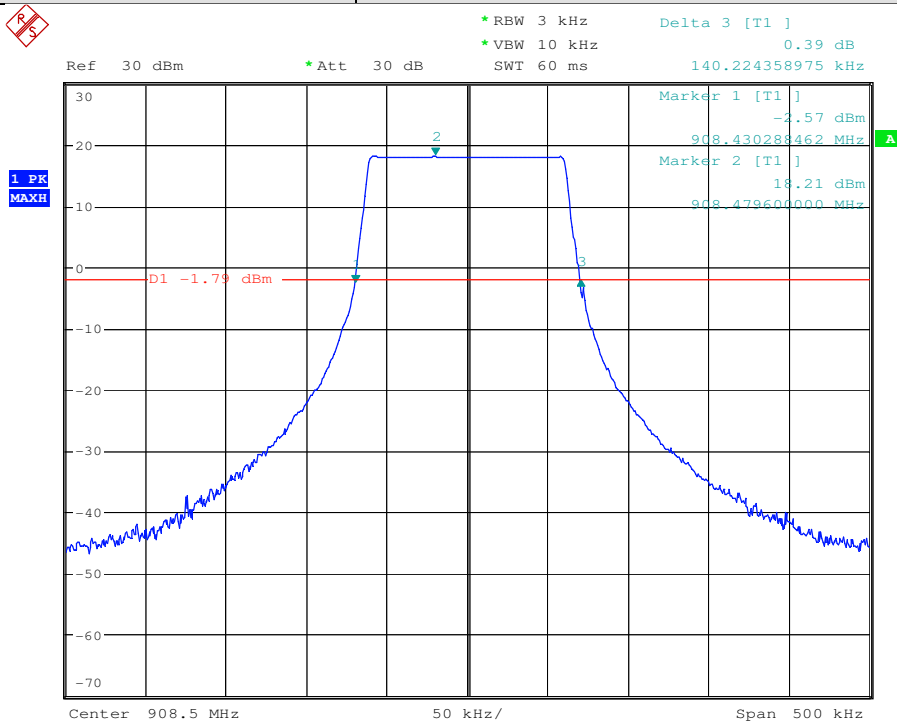



125KHz Channel Test channel: 914.9MHz

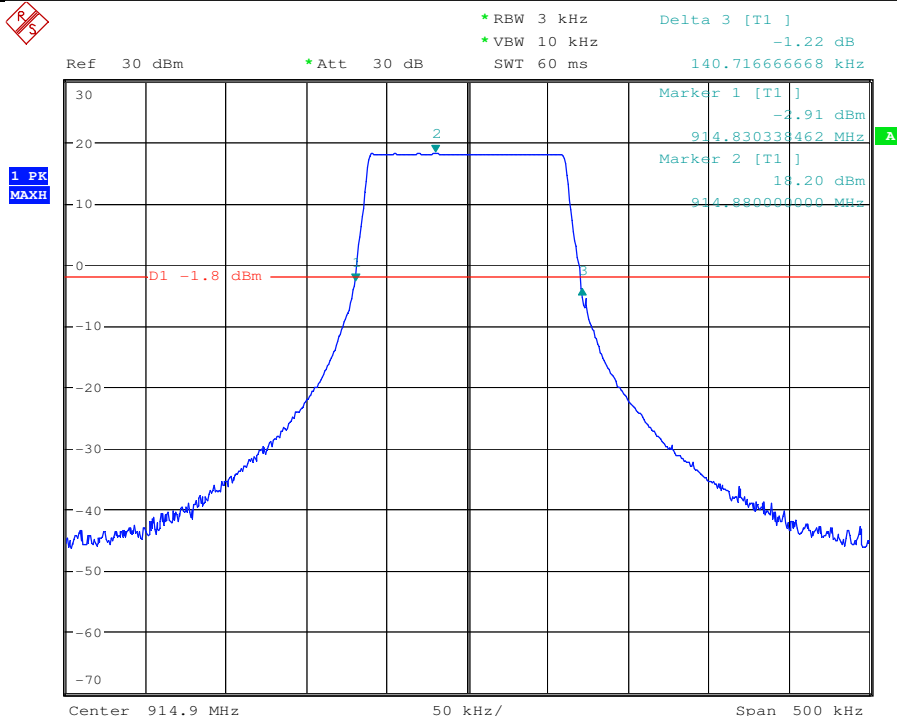

6.6 Maximum Conducted (Average) Output Power

Test Configuration:

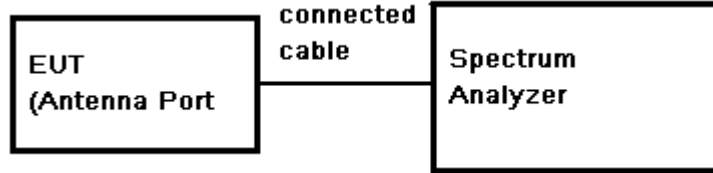

Test Procedure:

- 1) Place the EUT on the table and set it in transmitting mode.
- 2) Remove the antenna from the EUT and then connect a low loss RF cable from the antenna port to the spectrum.
- 3) Set span to at least 1.5 times the OBW
- 4) Set RBW = 1% to 5% of the OBW, not to exceed 1 MHz
- 5) Set VBW \geq (3 \times RBW)
- 6) Set number of points in sweep =30000
- 7) Set Detector = RMS, Sweep time = auto
- 8) Trace average at least 100 traces in power averaging (rms) mode
- 9) Use the instrument's band/channel power measurement function with the band limits set equal to the OBW bandwidth edges
- 10) Record the Max. power channel reading value.
- 11) Repeat above procedures until all the frequency measured were complete.

Test Limit: 30dBm

Test Result: Pass

Test Data:

Test mode	Test Channel(MHz)	Reading Power (dBm)	Output Power (dBm)	Limit (dBm)	Result
125KHz Channel	902.3	18.23	18.73	30	Pass
	908.5	17.61	18.11		Pass
	914.9	17.36	17.86		Pass
500KHz Channel	903	17.54	18.04		Pass
	907.8	17.59	18.09		Pass
	914.2	17.57	18.07		Pass

Remark: 1) Output Peak Power = Reading Peak Power + Cable loss
2) Cable loss=0.5dB

Test plot as follows:

125KHz Channel	Test Channel: 902.3MHz
----------------	------------------------

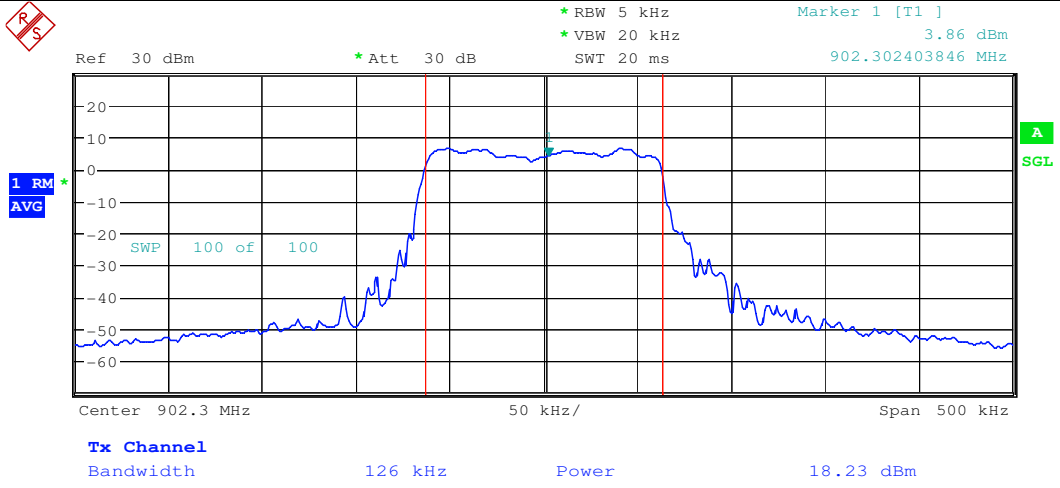

125KHz Channel	Test Channel: 908.5MHz
----------------	------------------------

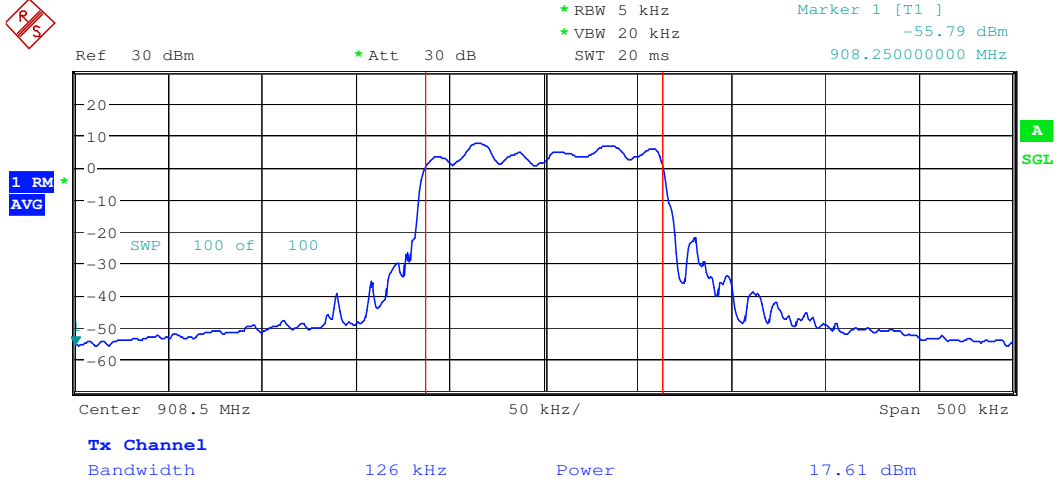

125KHz Channel	Test Channel: 914.9MHz
----------------	------------------------

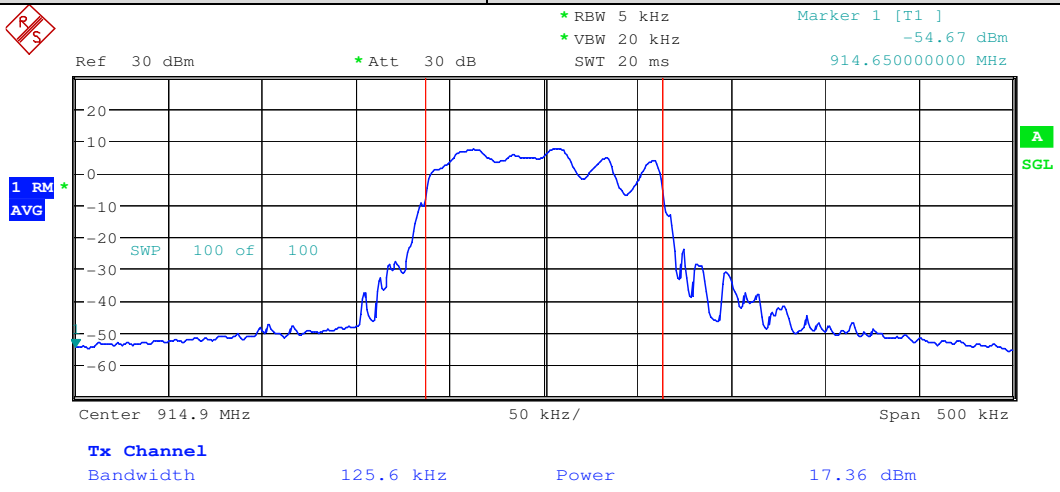

This document is issued by the Company subject to its General Conditions of Service printed overleaf, available on request or accessible at www.sgs.com/terms_and_conditions.htm and, for electronic format documents, subject to Terms and Conditions for Electronic Documents at www.sgs.com/terms_e-document.htm. Attention is drawn to the limitation of liability, indemnification and jurisdiction issues defined therein. Any holder of this document is advised that information contained hereon reflects the Company's findings at the time of its intervention only and within the limits of Client's instructions, if any. The Company's sole responsibility is to its Client and this document does not exonerate parties to a transaction from exercising all their rights and obligations under the transaction documents. This document cannot be reproduced except in full, without prior written approval of the Company. Any unauthorized alteration, forgery or falsification of the content or appearance of this document is unlawful and offenders may be prosecuted to the fullest extent of the law. Unless otherwise stated the results shown in this test report refer only to the sample(s) tested and such sample(s) are retained for 90 days only

500KHz Channel	Test Channel: 903MHz
----------------	----------------------

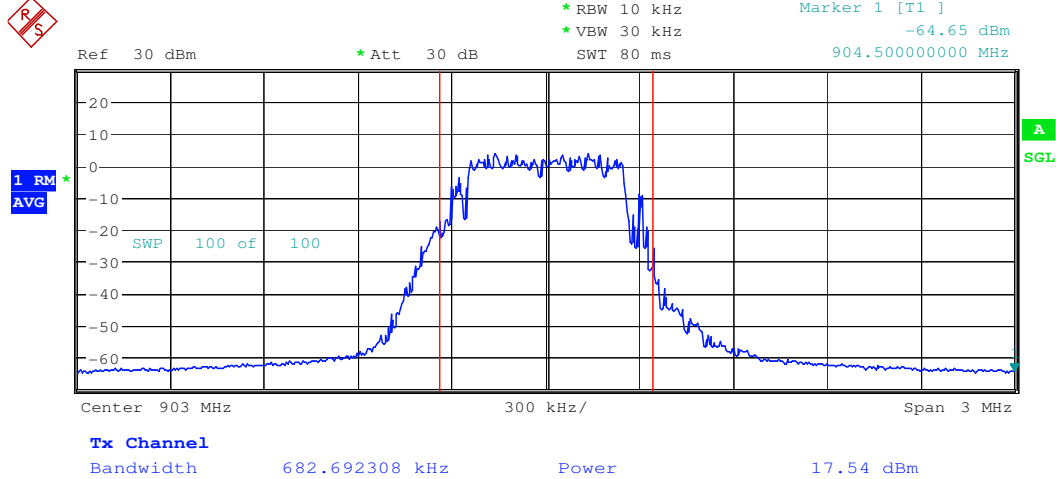

500KHz Channel	Test Channel: 907.8MHz
----------------	------------------------

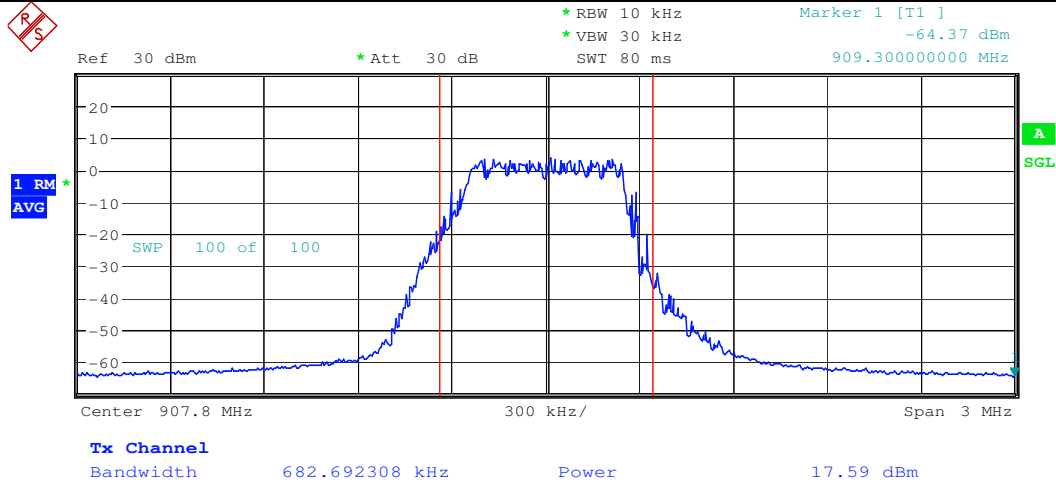

500KHz Channel	Test Channel: 914.2MHz
----------------	------------------------

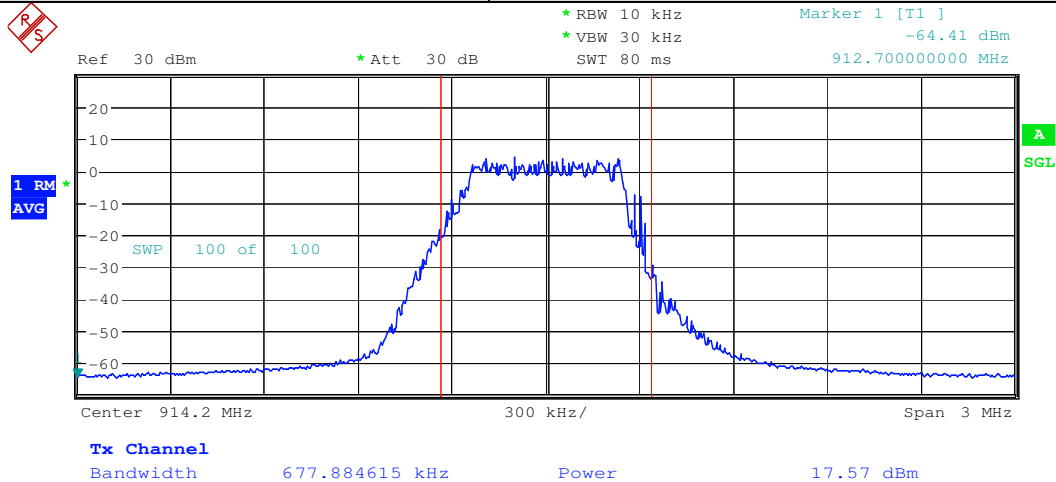

6.7 Power Spectral Density

Test Configuration:

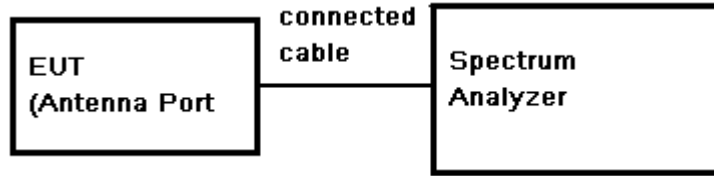

Test Procedure:

- 1) Remove the antenna from the EUT and then connect a low RF cable from the antenna port to the spectrum.
- 2) Set the spectrum analyzer: Center Frequency= Channel Frequency, RBW = 3 kHz, VBW = 10 kHz. Span= 1.5 times the OBW bandwidth, Sweep = auto; Detector = RMS
- 3) Set number of points in sweep =30000
- 4) Employ trace averaging (rms) mode over a minimum of 100 traces
- 5) Use the peak marker function to determine the maximum amplitude level within the RBW.
- 6) Record the marker level for the particular mode.
- 7) Repeat these steps for other channel and modes.

Test Limit:

DTS: 8dBm/3kHz
Hybrid System: 8dBm/3kHz

Test Result:

Pass

Test Data:

Test mode	Test Channel(MHz)	Reading Value (dBm/3KHz)	PSD (dBm/3KHz)	Limit (dBm/3KHz)	Result
125KHz Channel	902.3	6.11	6.61	8	Pass
	908.5	5.76	6.26		Pass
	914.9	6.28	6.78		Pass
500KHz Channel	903	-3.46	-2.96		Pass
	907.8	-2.91	-2.41		Pass
	914.2	-3.09	-2.59		Pass

Remark: 1) Output Peak Power = Reading Peak Power + Cable loss

2) Cable loss=0.5dB

Test plot as follows:

125KHz Channel	Test Channel: 902.3MHz
----------------	------------------------

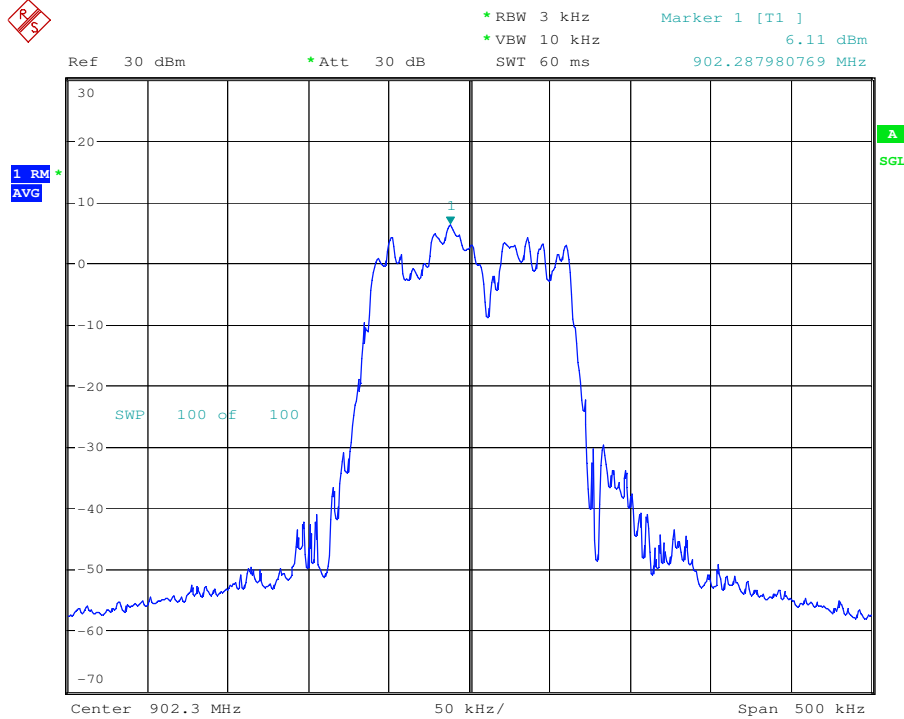

125KHz Channel	Test Channel: 908.5MHz
----------------	------------------------

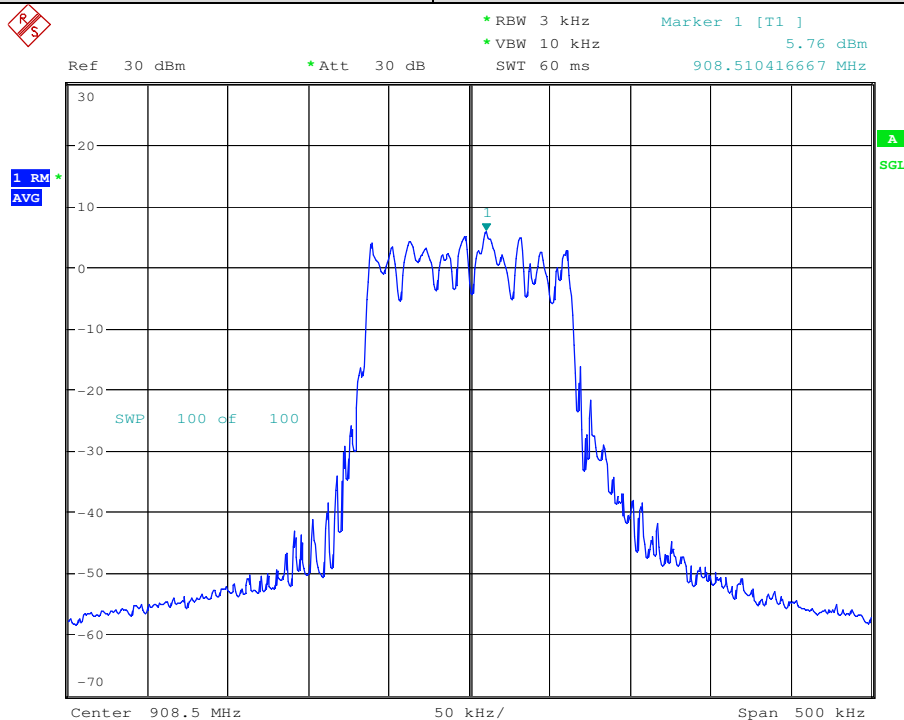



125KHz Channel Test Channel: 914.9MHz

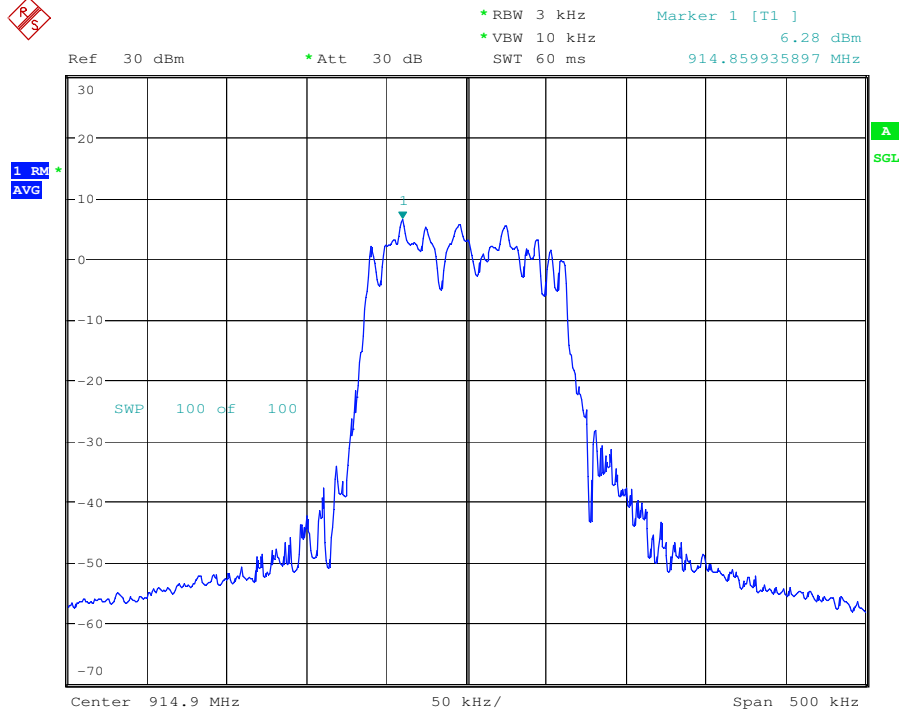

500KHz Channel Test Channel: 903MHz

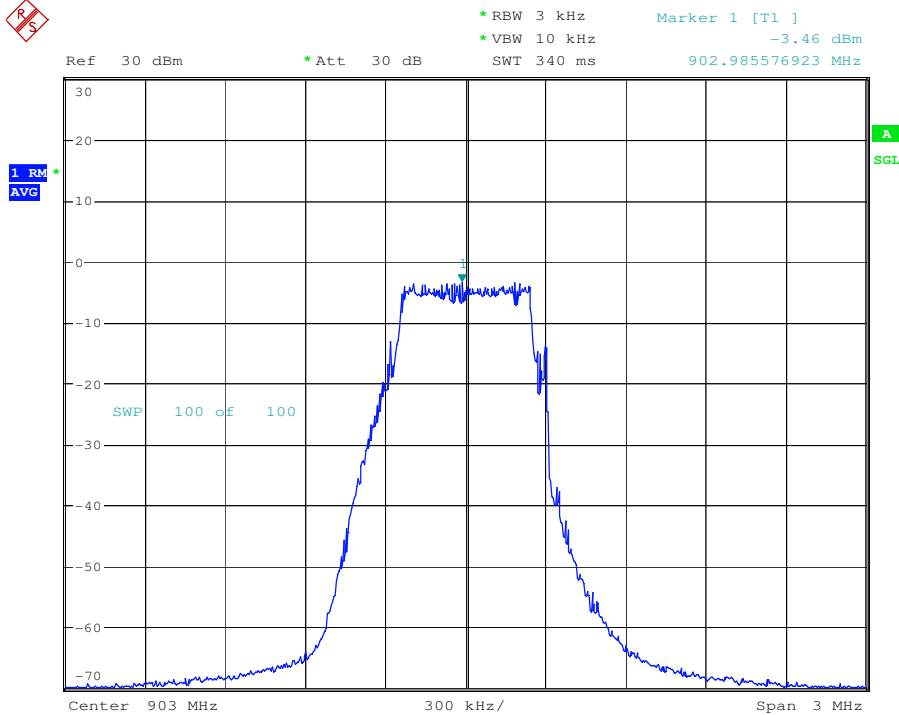

This document is issued by the Company subject to its General Conditions of Service printed overleaf, available on request or accessible at www.sgs.com/terms_and_conditions.htm and, for electronic format documents, subject to Terms and Conditions for Electronic Documents at www.sgs.com/terms_e-document.htm. Attention is drawn to the limitation of liability, indemnification and jurisdiction issues defined therein. Any holder of this document is advised that information contained hereon reflects the Company's findings at the time of its intervention only and within the limits of Client's instructions, if any. The Company's sole responsibility is to its Client and this document does not exonerate parties to a transaction from exercising all their rights and obligations under the transaction documents. This document cannot be reproduced except in full, without prior written approval of the Company. Any unauthorized alteration, forgery or falsification of the content or appearance of this document is unlawful and offenders may be prosecuted to the fullest extent of the law. Unless otherwise stated the results shown in this test report refer only to the sample(s) tested and such sample(s) are retained for 90 days only

500KHz Channel	Test Channel: 907.8MHz
----------------	------------------------

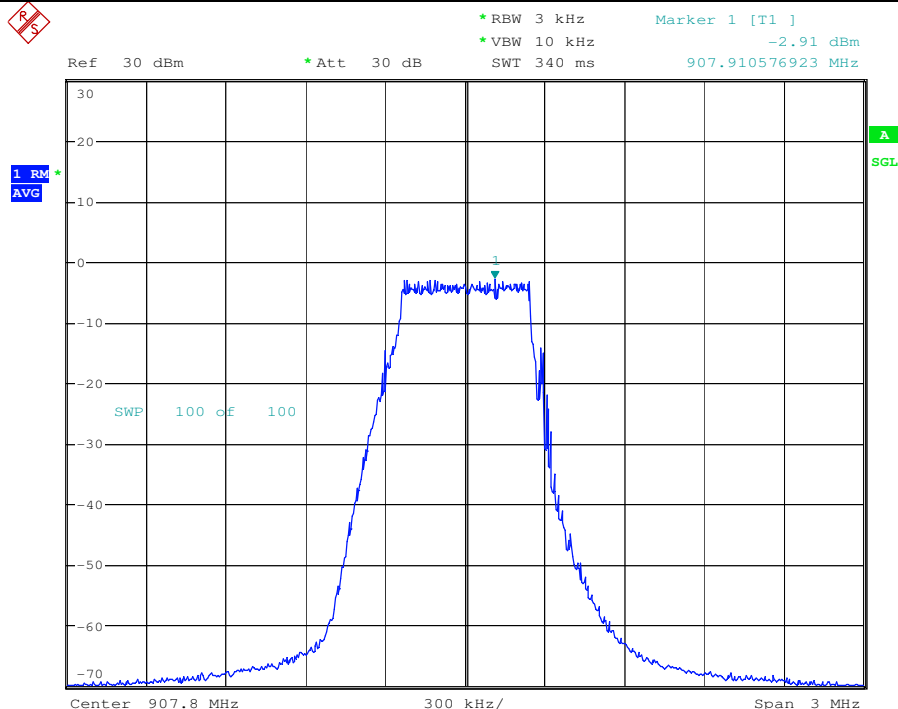

500KHz Channel	Test Channel: 914.2MHz
----------------	------------------------

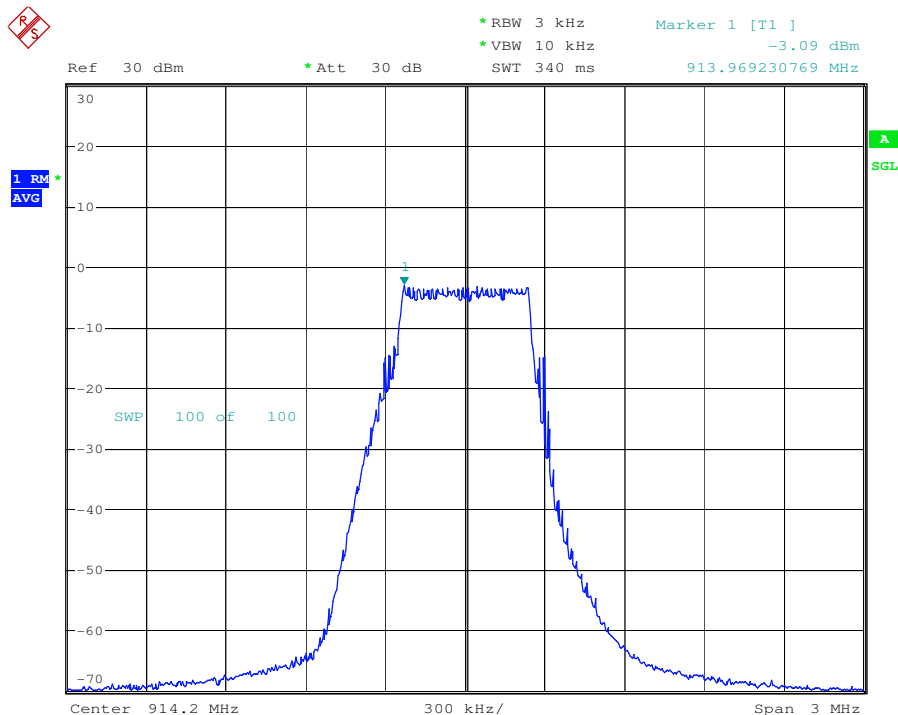

6.8 Carrier Frequencies Separated

Test Configuration:

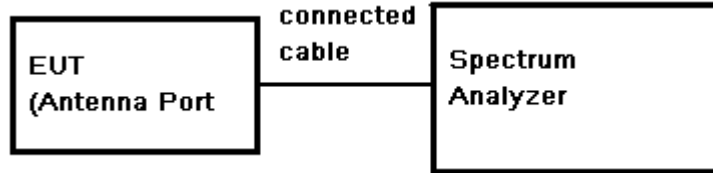

Test Procedure:

- 1) Remove the antenna from the EUT and then connect a low RF cable from the antenna port to the spectrum.
- 2) Set the spectrum analyzer: RBW \geq 1% of the span. VBW \geq 3 x RBW, Span = 500KHz. Sweep = auto; Detector Function = Peak. Trace = Maxhold.
- 3) Allow the trace to stabilize. Use the marker-delta function to determine the separation between the peaks of the adjacent channels. The limit is specified in one of the subparagraphs of this Section. Submit this plot.

Limit:

0.025MHz or the 20dB bandwidth (whichever is greater)

Test data:

Test Mode	Test Channel	Carrier Frequencies Separated (KHz)	Limit (KHz)	Test Result
125KHz Channel	Middle Channels (Channel 31 & 32)	200.49	140.72	Pass

Remark: 1. 20dB bandwidth reference Section 7.5

Test plot as follows:

125KHz Channel	Test channel: Channel 31 & 32
----------------	-------------------------------

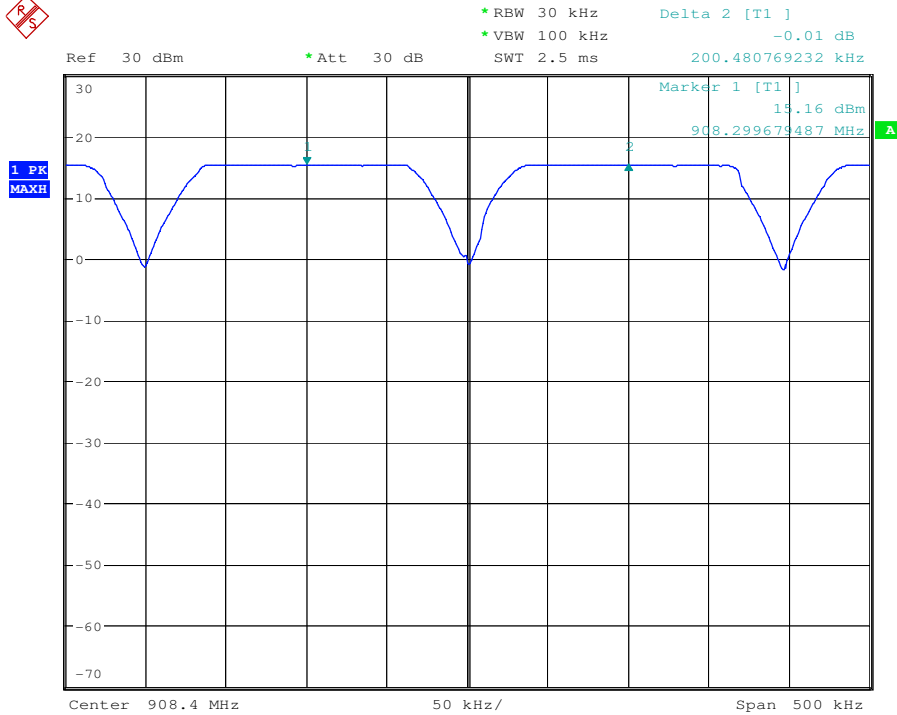

6.9 Hopping Channel Number

Test Configuration:

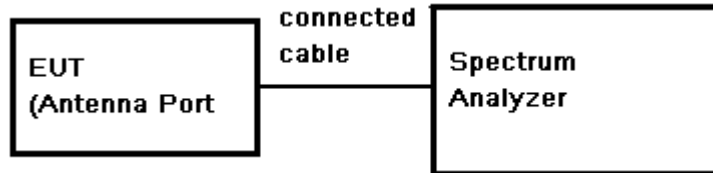

Test Procedure:

- 1) Remove the antenna from the EUT and then connect a low RF cable from the antenna port to the spectrum.
- 2) Set the spectrum analyzer: RBW = 30 kHz. VBW = 100 kHz. Sweep = auto; Detector Function = Peak. Trace = Max hold.
- 3) Allow the trace to stabilize. It may prove necessary to break the span up to sections. in order to clearly show all of the hopping frequencies. The limit is specified in one of the subparagraphs of this Section.
- 4) Set the spectrum analyzer: start frequency = 902MHz. stop frequency = 916MHz. Submit the test result graph.

Limit:

There is no minimum number of channels for hybrid system

Test Data:

Mode	Hopping channel numbers	Test Result
125KHz Channel	64	Pass

Test plot as follows:

Test mode: 125KHz Channel

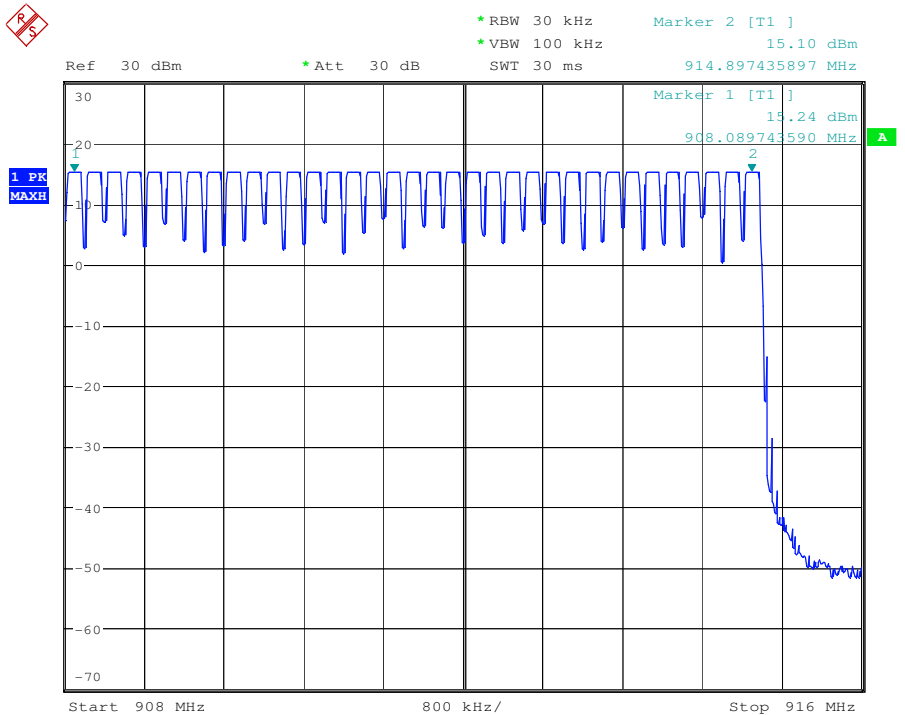
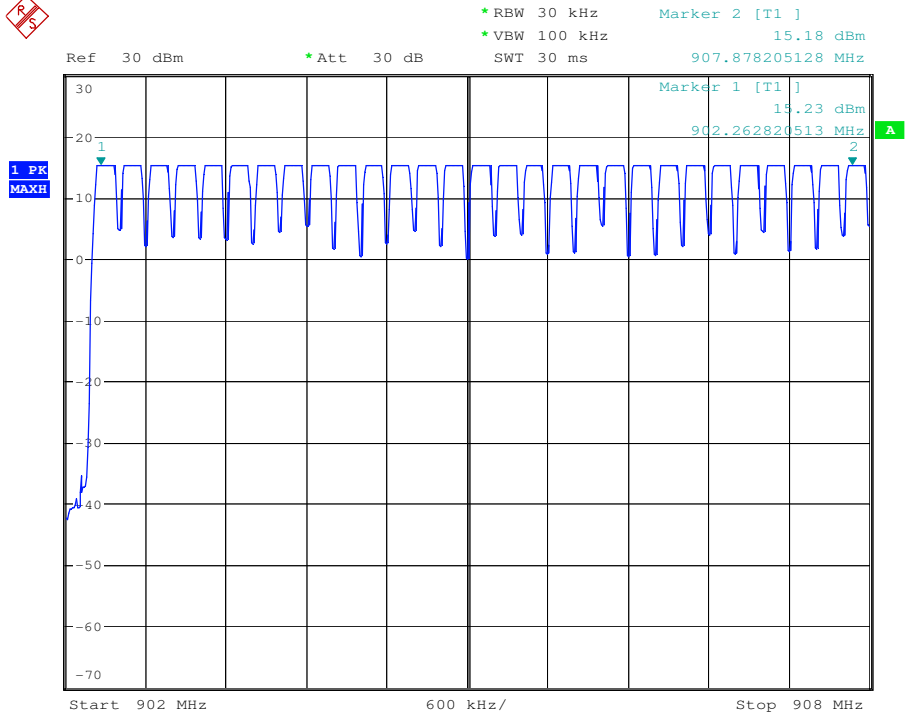

6.10 Average Time of Occupancy

Test Configuration:

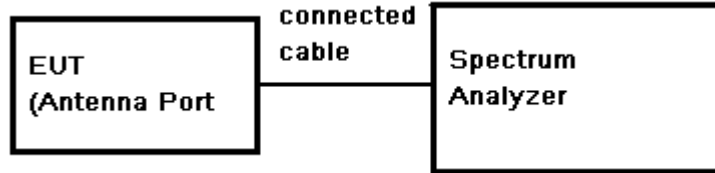

Test Procedure:

- 1) Remove the antenna from the EUT and then connect a low RF cable from the antenna port to the spectrum. Keep EUT in Hopping transmitting with all kind of modulation.
- 2) Set spectrum analyzer span = 0. centered on a hopping channel;
- 3) Use Emission width * No. of Hopping Channels in 25.6s to determine the total time occupancy

Limit:

Regulation 15.247(f), For the purposes of this section, hybrid systems are those that employ a combination of both frequency hopping and digital modulation techniques. The frequency hopping operation of the hybrid system, with the direct sequence or digital modulation operation turned-off, shall have an average time of occupancy on any frequency not to exceed 0.4 seconds within a time period in seconds equal to the number of hopping frequencies employed multiplied by 0.4.

Test Data:

Test Mode	Test Frequency	Emission Width (ms)	Number of Hopping Channel in 25.6s	Average Occupancy Time (s)	Limit (s)	Test Result
125kHz Channel	908.5MHz	395.83	1	0.396	0.4	Pass

Test plot as follows:

Test mode:125KHz Channel	Test channel:908.5
--------------------------	--------------------

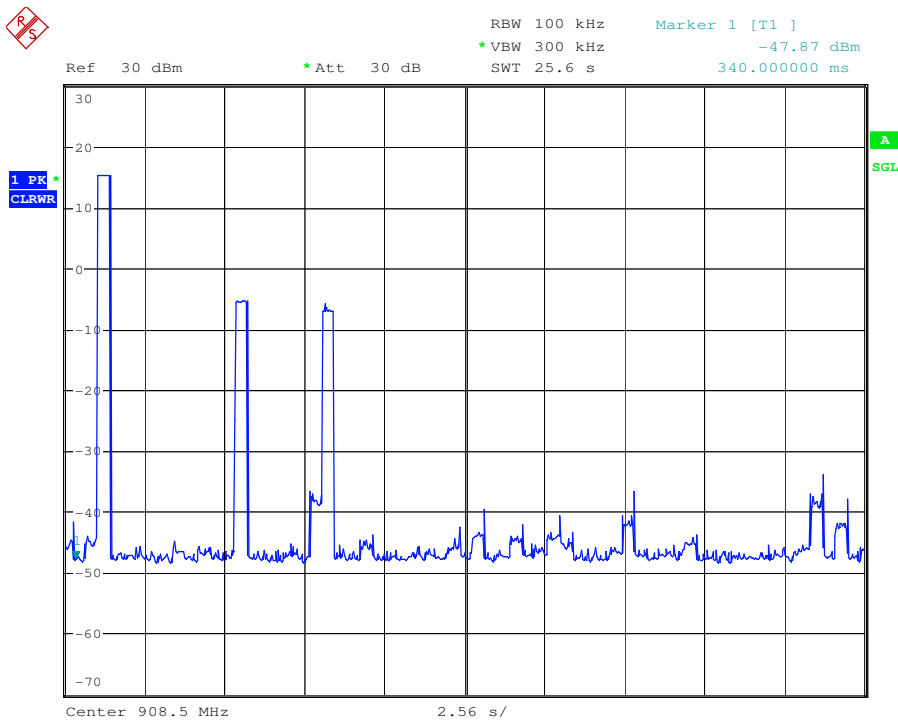
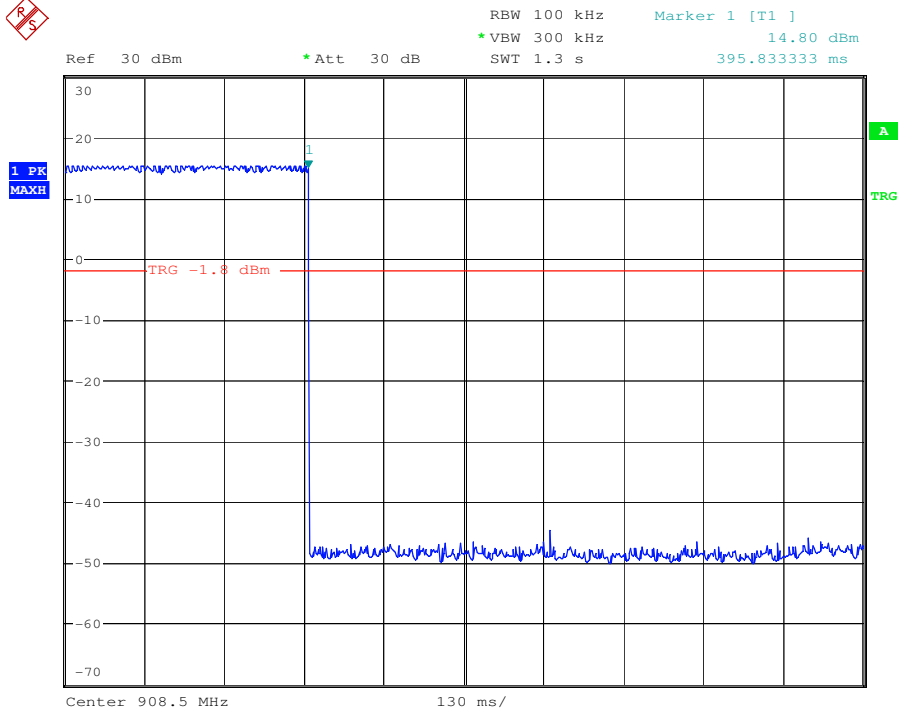

6.11 Conducted Spurious Emissions and Band-edge

Test Configuration:

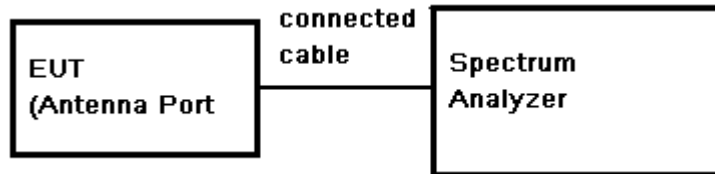

Test Procedure:

- 1) Remove the antenna from the EUT and then connect a low RF cable from the antenna port to the spectrum.
- 2) Set the spectrum analyzer: RBW = 100KHz. VBW = 300KHz.
Sweep = auto; Detector Function = Peak (Max. hold).

Limit:

(d) In any 100 kHz bandwidth outside the frequency band in which the spread spectrum or digitally modulated intentional radiator is operating, the radio frequency power that is produced by the intentional radiator shall be at least 20 dB below that in the 100 kHz bandwidth within the band that contains the Highest level of the desired power, based on either an RF conducted or a radiated measurement, provided the transmitter demonstrates compliance with the peak conducted power limits.

Test Result:

Pass

6.11.1 Conducted spurious emission

Test plot as follows:

125KHz Channel	Test Channel: 902.3MHz
----------------	------------------------

30MHz-3GHz:

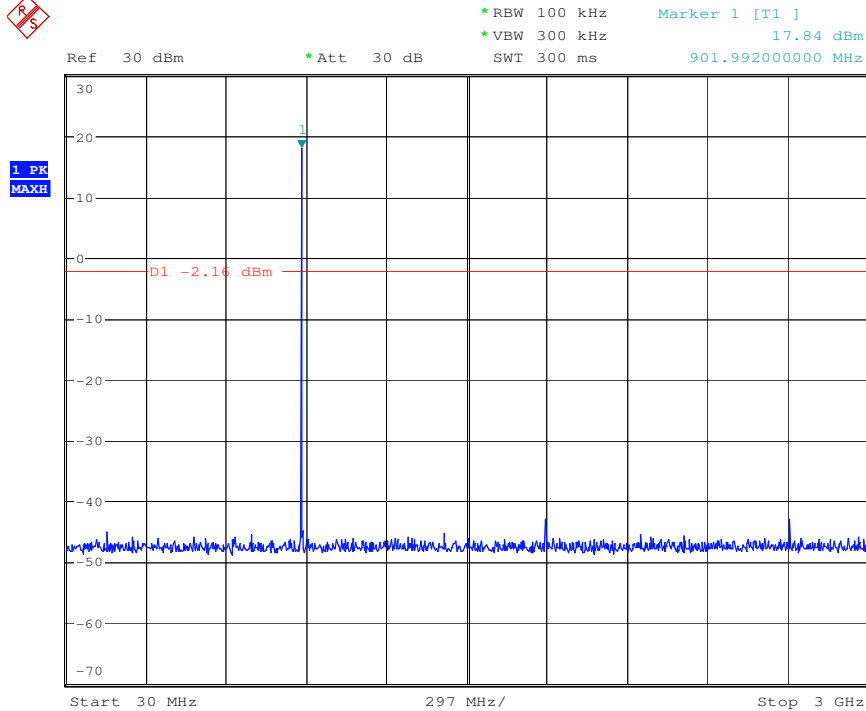

3GHz-25GHz:

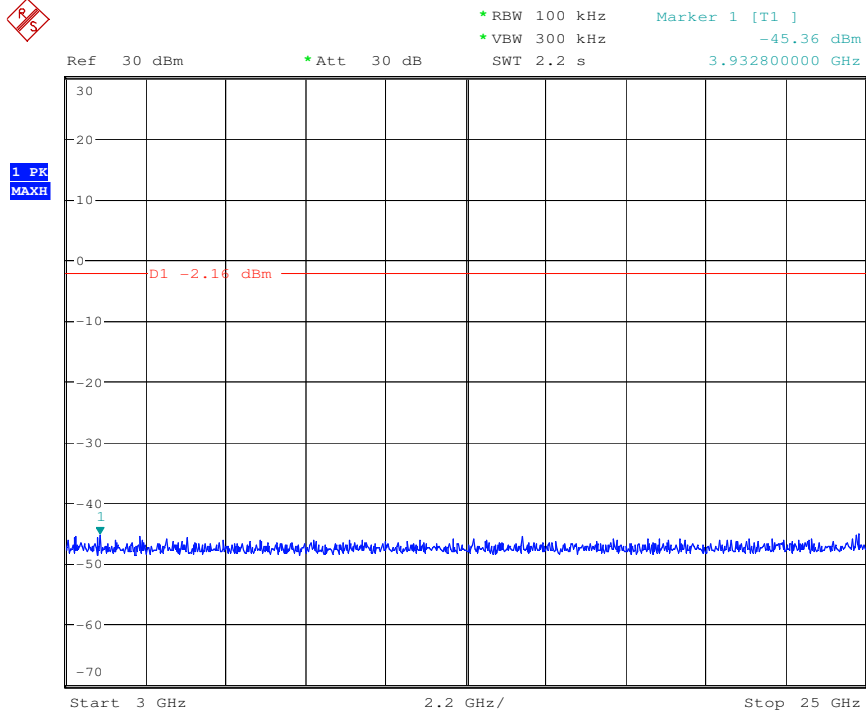

125KHz Channel Test Channel: 908.5MHz

30MHz-3GHz:

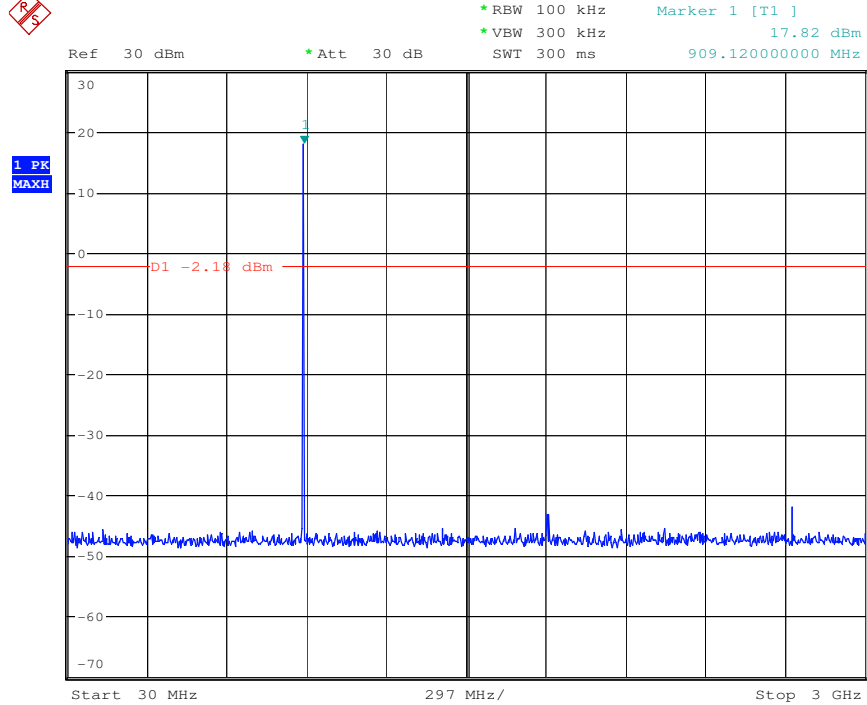

3GHz-25GHz:

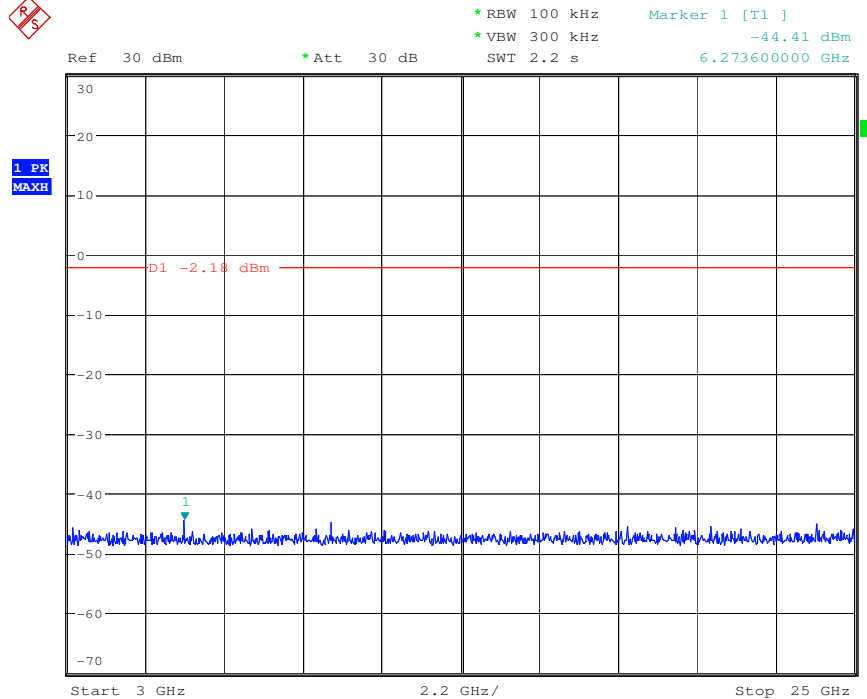

125KHz Channel Test Channel: 914.9MHz

30MHz-3GHz:

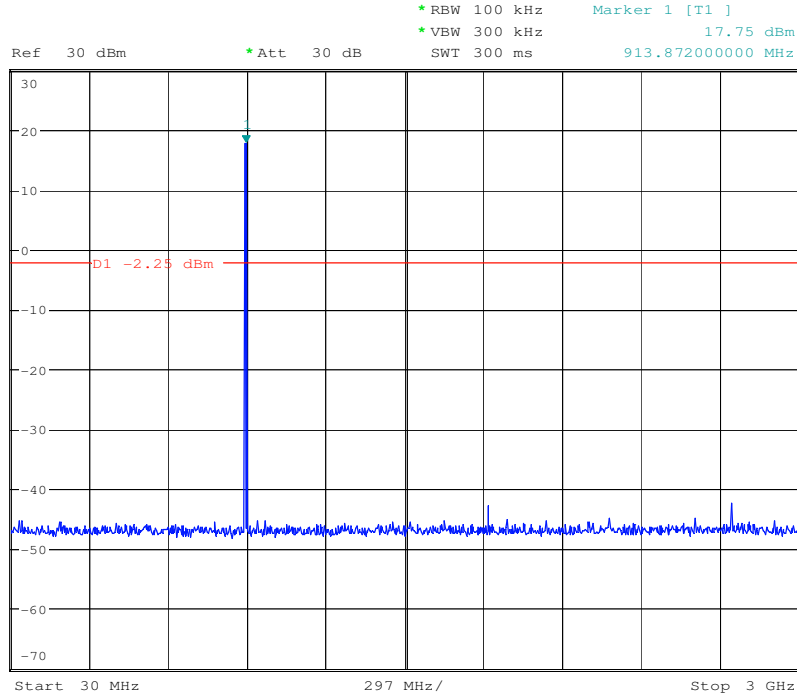

3GHz-25GHz:

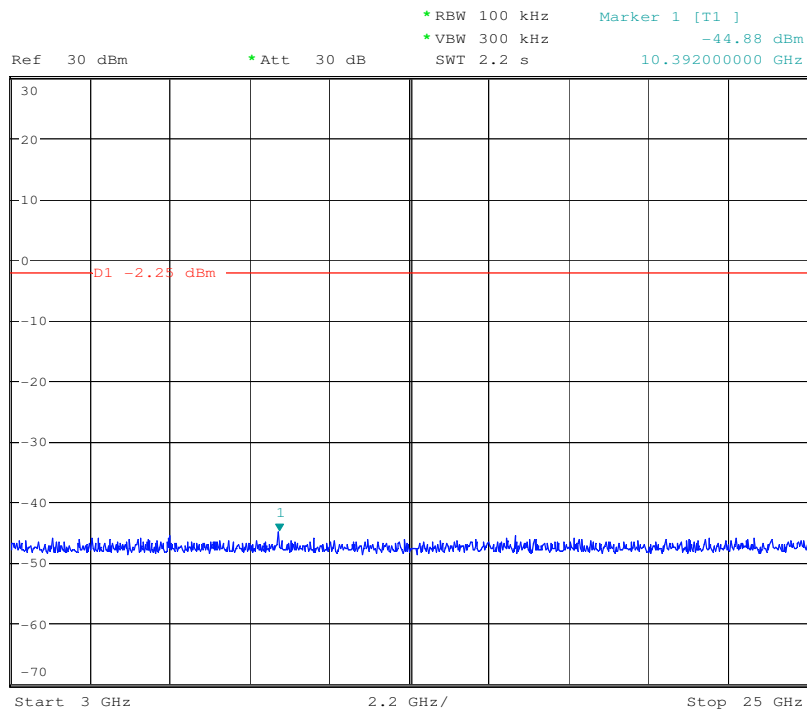

500KHz Channel Test Channel: 903MHz

30MHz-3GHz:

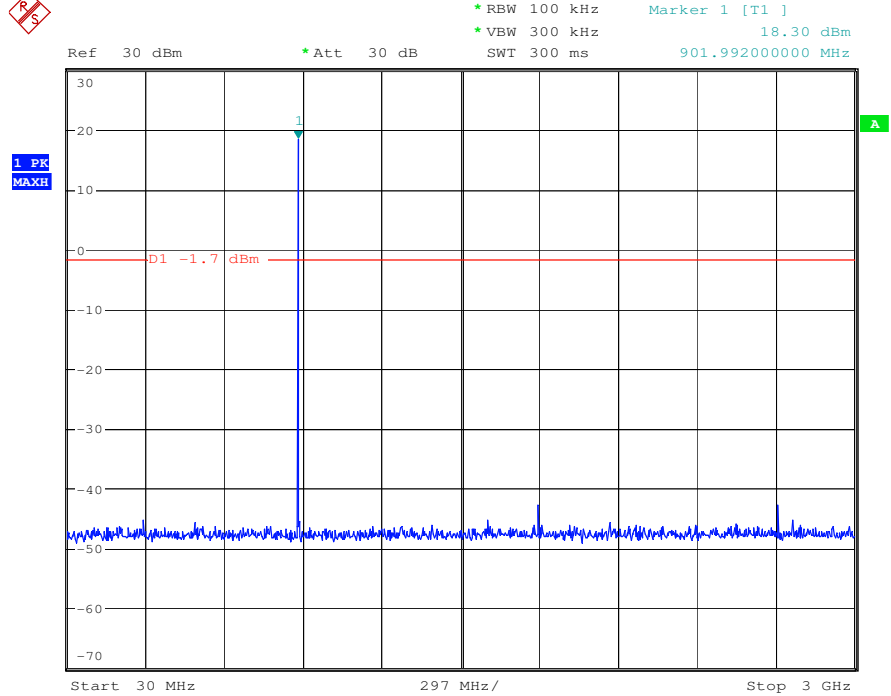

3GHz-25GHz:

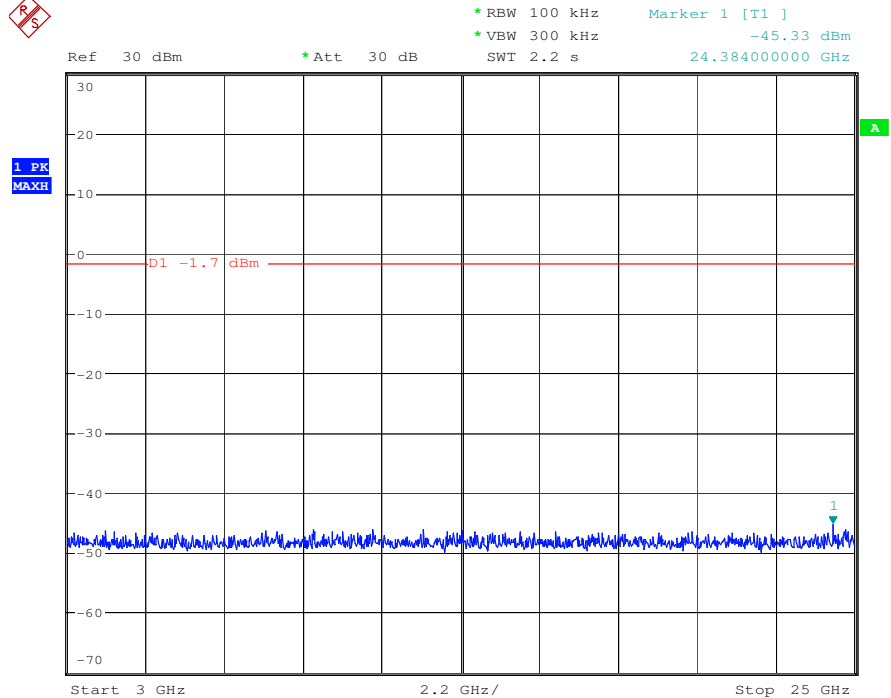

500KHz Channel Test Channel: 907.8MHz

30MHz-3GHz:

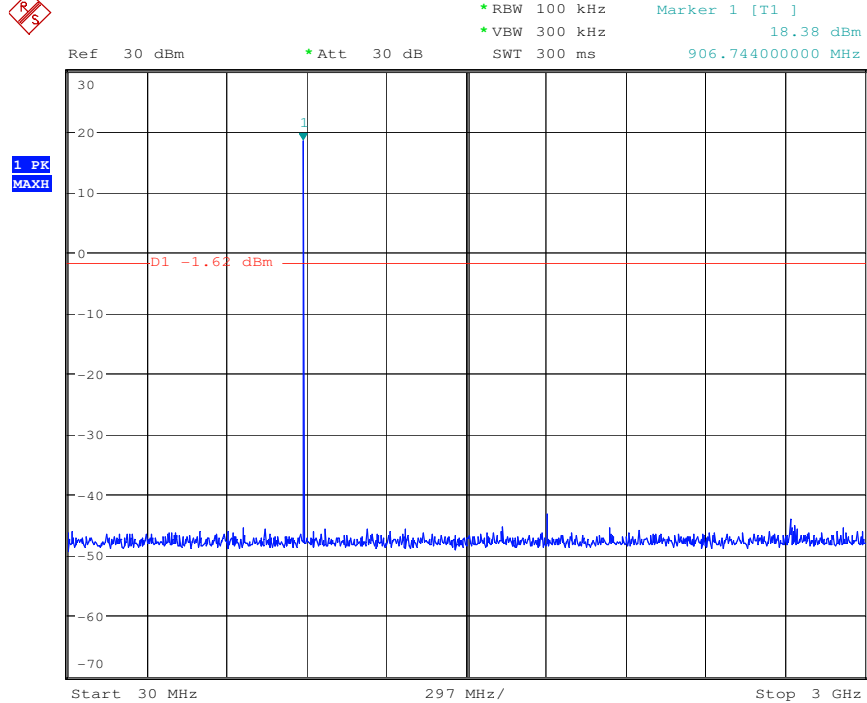

3GHz-25GHz:

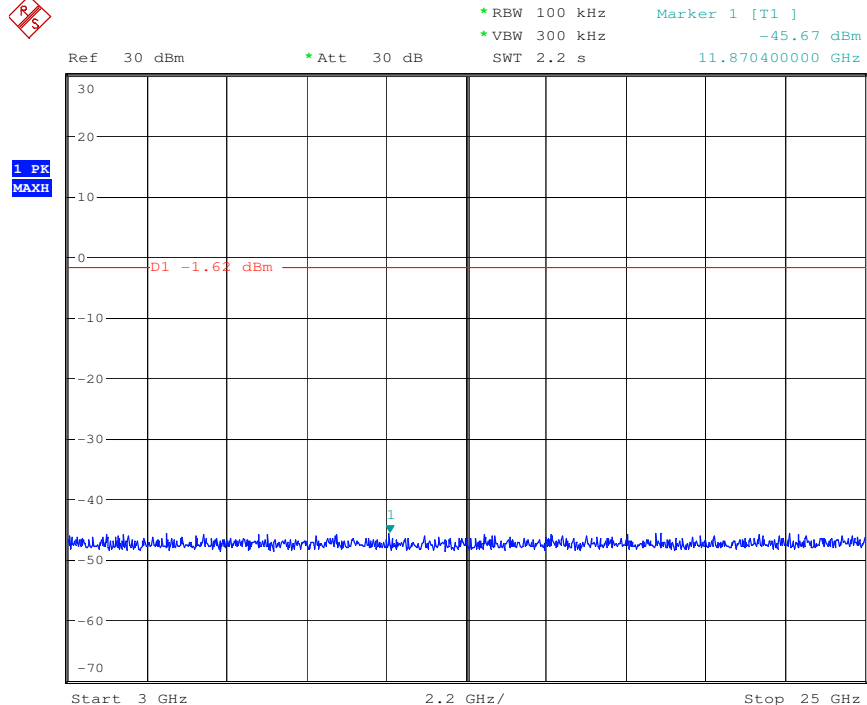

500KHz Channel Test Channel: 914.2MHz

30MHz-3GHz:

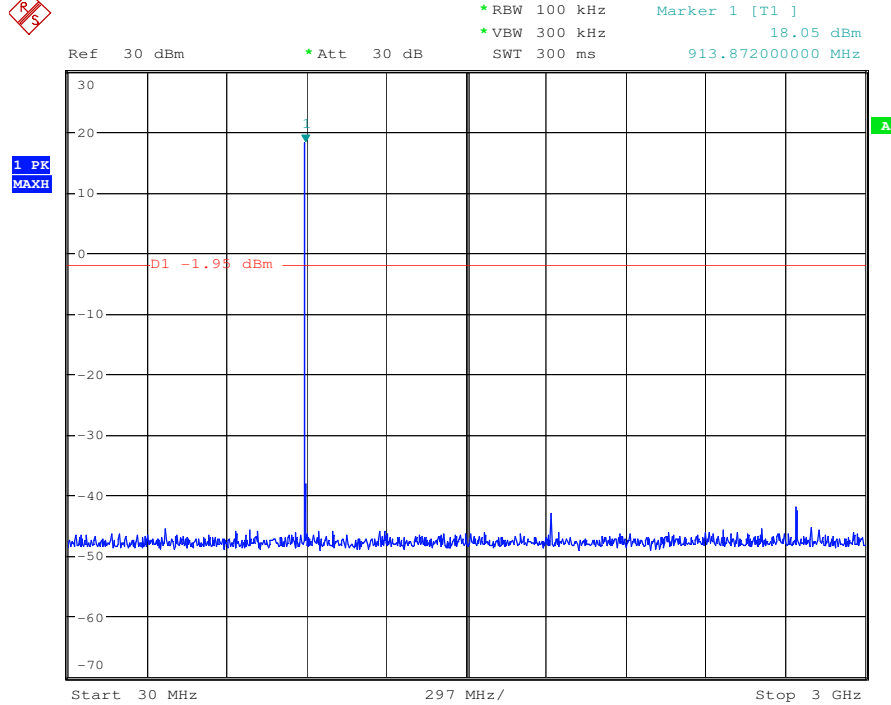

3GHz-25GHz:

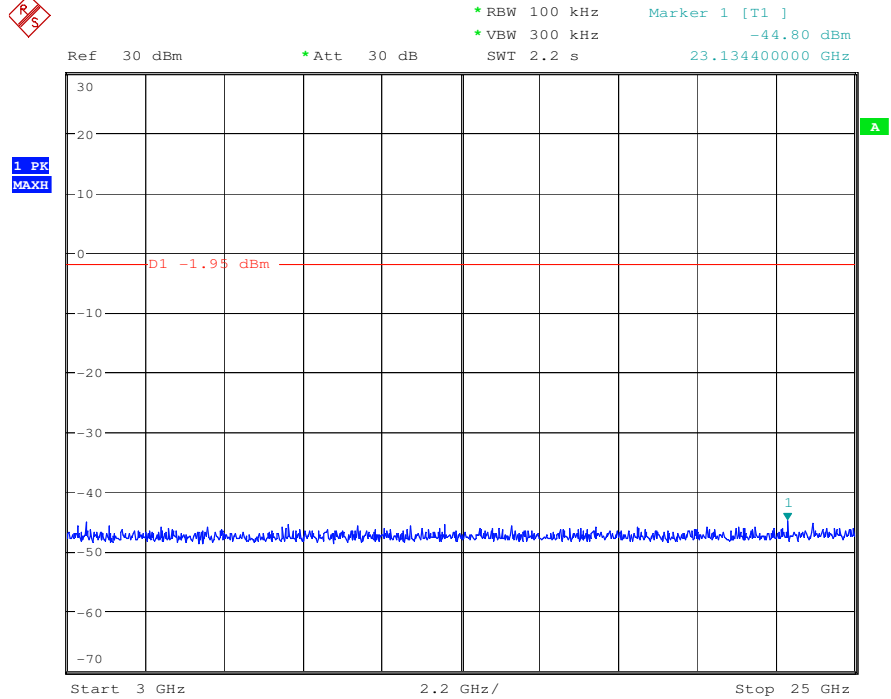

6.11.2 Conducted Band-edge

Test plot as follows:

125KHz Channel	Hopping disabled- 902.3MHz
----------------	----------------------------

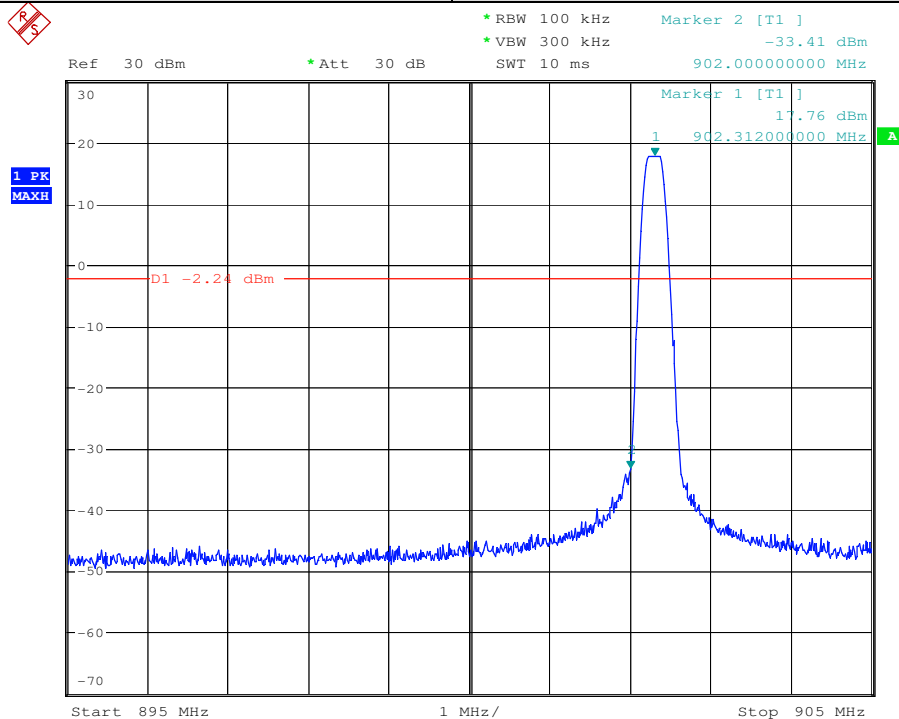

125KHz Channel	Hopping disabled- 914.9MHz
----------------	----------------------------

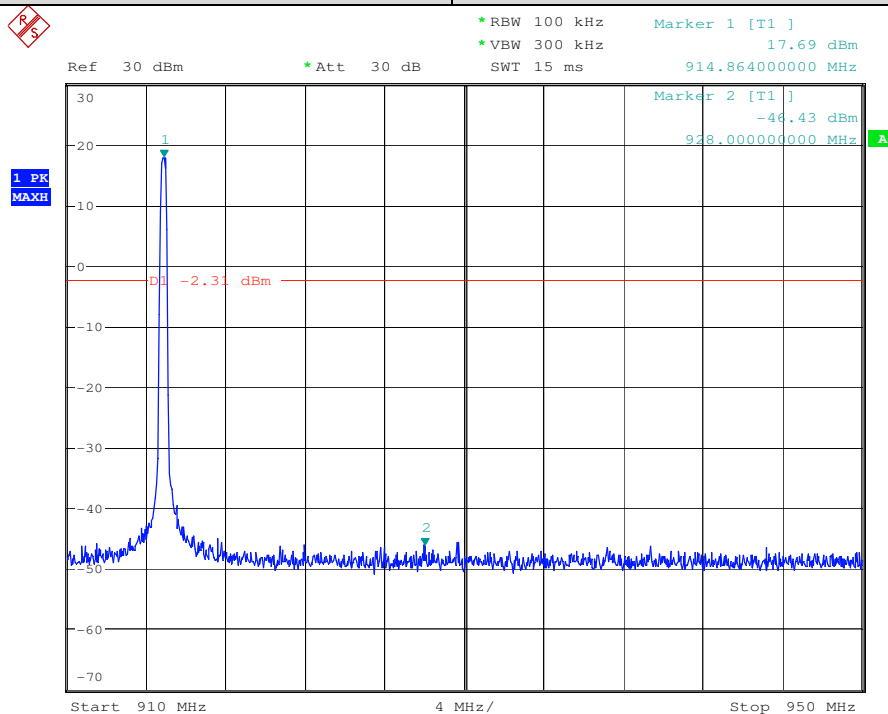



125KHz Channel Hopping enabled

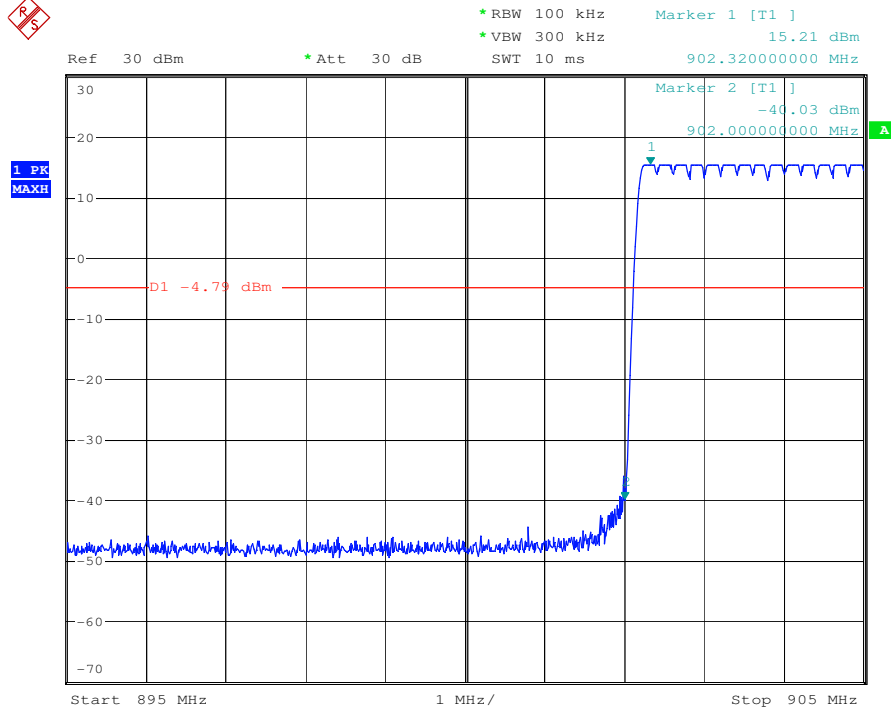

125KHz Channel Hopping enabled

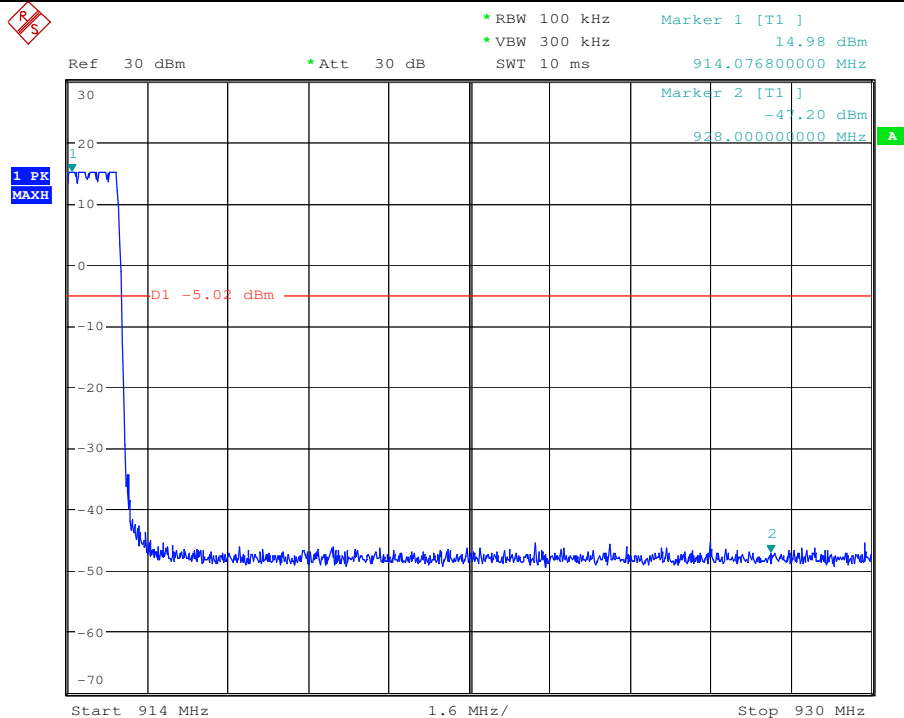



500KHz Channel Test Channel: 903MHz

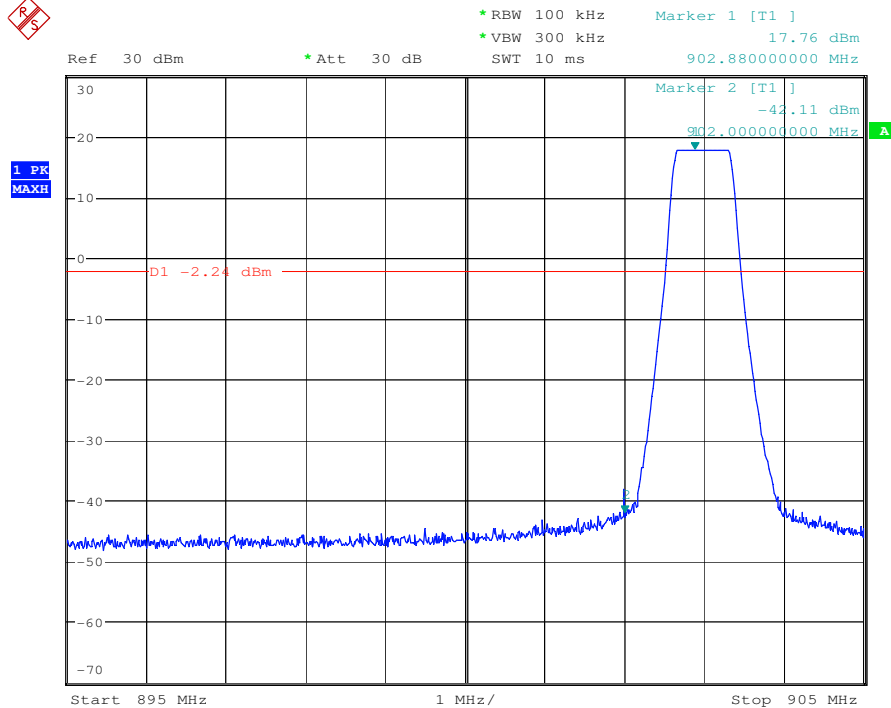

500KHz Channel Test Channel: 914.2MHz

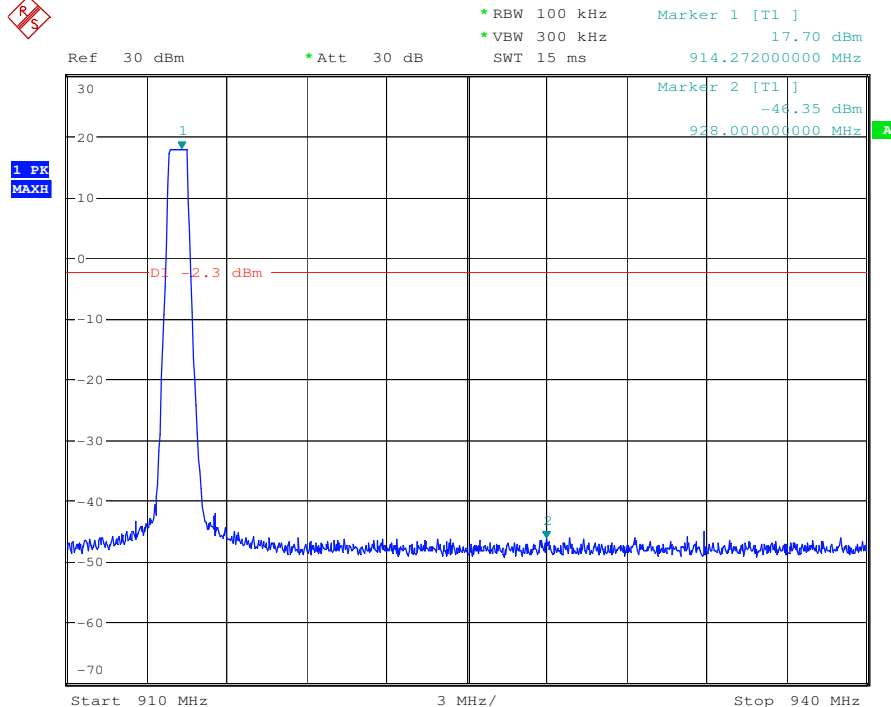

6.12 Radiated Spurious Emissions and Band-edge

Frequency Range: 9KHz to 25GHz

Test site/setup: Measurement Distance: 3m
Test instrumentation set-up:

Frequency Range	Detector	RBW	VBW
0.009MHz-0.090MHz	Peak	10kHz	30kHz
0.009MHz-0.090MHz	Average	10kHz	30kHz
0.090MHz-0.110MHz	Quasi-peak	10kHz	30kHz
0.110MHz-0.490MHz	Peak	10kHz	30kHz
0.110MHz-0.490MHz	Average	10kHz	30kHz
0.490MHz -30MHz	Quasi-peak	10kHz	30kHz
30MHz-1GHz	Quasi-peak	100kHz	300kHz
Above 1GHz	Peak	RBW=1MHz	VBW≥RBW
	Average		VBW=10Hz

Sweep=Auto

15.209 Limit:

Frequency	Field strength (microvolt/meter)	Limit (dBuV/m)
0.009MHz-0.490MHz	2400/F(KHz)	128.5 ~ 93.8
0.490MHz-1.705MHz	24000/F(KHz)	73.8 ~63.0
1.705MHz-30MHz	30	69.5
30MHz-88MHz	100	40.0
88MHz-216MHz	150	43.5
216MHz-960MHz	200	46.0
960MHz-1GHz	500	54.0
Above 1GHz	500	54.0

Note: 15.35(b), Unless otherwise specified, the limit on peak radio frequency emissions is 20dB above the maximum permitted average emission limit applicable to the equipment under test. This peak limit applies to the total peak emission level radiated by the device.

Test Configuration:

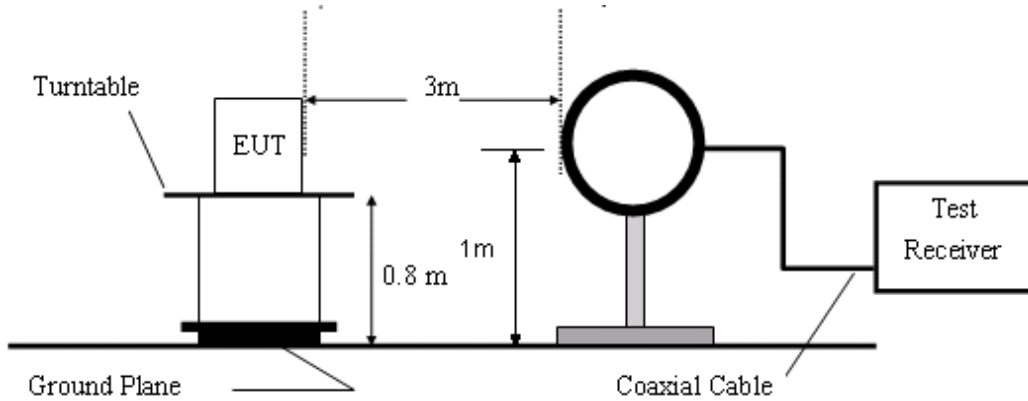

Figure1. Below 30MHz radiated emissions test configuration

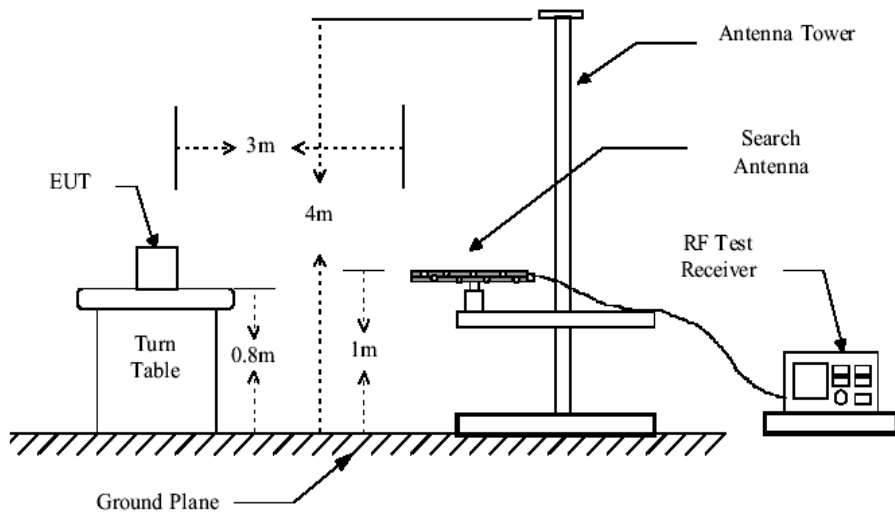

Figure2. 30MHz to 1GHz radiated emissions test configuration

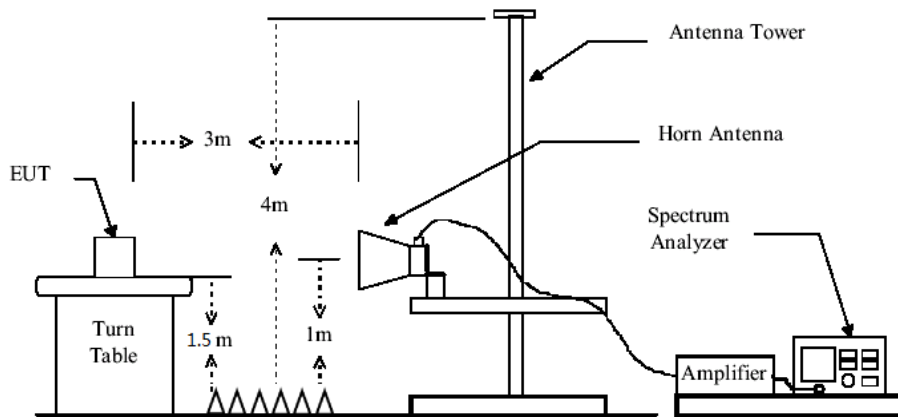

Figure3. Above 1GHz radiated emissions test configuration

- Test Procedure:**
- 1) The procedure used was ANSI Standard C63.10. The receiver was scanned from 9 KHz to 25GHz. When an emission was found, the table was rotated to produce the maximum signal strength. An initial pre-scan was performed for in peak detection mode using the receiver. The EUT was measured for both the Horizontal and Vertical polarities and performed a pre-test three orthogonal planes. For intentional radiators, measurements of the variation of the input power or the radiated signal level of the fundamental frequency component of the emission, as appropriate, shall be performed with the supply voltage varied between 85% and 115% of the nominal rated supply voltage. The worst case emissions were reported.
 - 2) Low noise amplifier was used below 1GHz, High pass Filter was used above 3GHz. We did not use any amplifier or filter between 1G and 3GHz.
 - 3) Test were performed for their spatial orthogonal(X, Y, Z), the worst test data (X orthogonal) was submitted.
 - a) For this intentional radiator operates below 25 GHz. the spectrum shall be investigated to the tenth harmonic of the highest fundamental frequency. And above the third harmonic of this intentional radiator, the disturbance is very low. So the test result only displays to 5rd harmonic.
 - b) As shown in Section, for frequencies above 1000MHz. the above field strength limits are based on average limits. However, the peak field strength of any emission shall not exceed the maximum permitted average limits specified above by more than 20 dB under any condition of modulation.
 - 4) Pretest under all modes below 1GHz; choose the worst case mode (802.11b) record on the report.
 - 5) No spurious emissions were detected within 20dB of limit below 30MHz.

Test Result: Pass

6.12.1 Radiated Spurious Emissions

Test mode: 125KHz Channel

Item	Freq.	Read Level	Antenna Factor	Preamp Factor	Cable Loss	Result Level	Limit Line	Over Limit	Detector	Polarization
(Mark)	(MHz)	(dBμV)	(dB/m)	(dB)	(dB)	(dBμV/m)	(dBμV/m)	(dB)		
1	40.70	43.77	13.64	28.80	0.97	29.58	40.00	-10.42	QP	Horizontal
2	120.28	45.37	11.80	28.60	1.31	29.88	43.50	-13.62	QP	Horizontal
3	287.99	45.27	12.44	27.90	2.15	31.96	46.00	-14.04	QP	Horizontal
4	455.91	40.78	16.58	29.10	2.76	31.02	46.00	-14.98	QP	Horizontal
5	821.71	36.70	23.72	29.07	3.90	35.25	46.00	-10.75	QP	Horizontal
6	986.07	37.15	24.27	28.78	4.24	36.88	54.00	-17.12	QP	Horizontal
1	40.70	43.63	13.64	28.80	0.97	29.44	40.00	-10.56	QP	VERTICAL
2	119.86	43.43	11.80	28.60	1.31	27.94	43.50	-15.56	QP	VERTICAL
3	455.91	39.61	16.58	29.10	2.76	29.85	46.00	-16.15	QP	VERTICAL
4	574.63	36.70	20.22	29.24	3.19	30.87	46.00	-15.13	QP	VERTICAL
5	810.27	36.92	23.61	29.08	3.87	35.32	46.00	-10.68	QP	VERTICAL
6	989.54	36.92	24.50	28.76	4.26	36.92	54.00	-17.08	QP	VERTICAL

Result Level = Read Level + Antenna Factor + Cable loss - Preamp Factor

Below is the plot of worst case on the highest channel 914.9MHz:
Vertical:

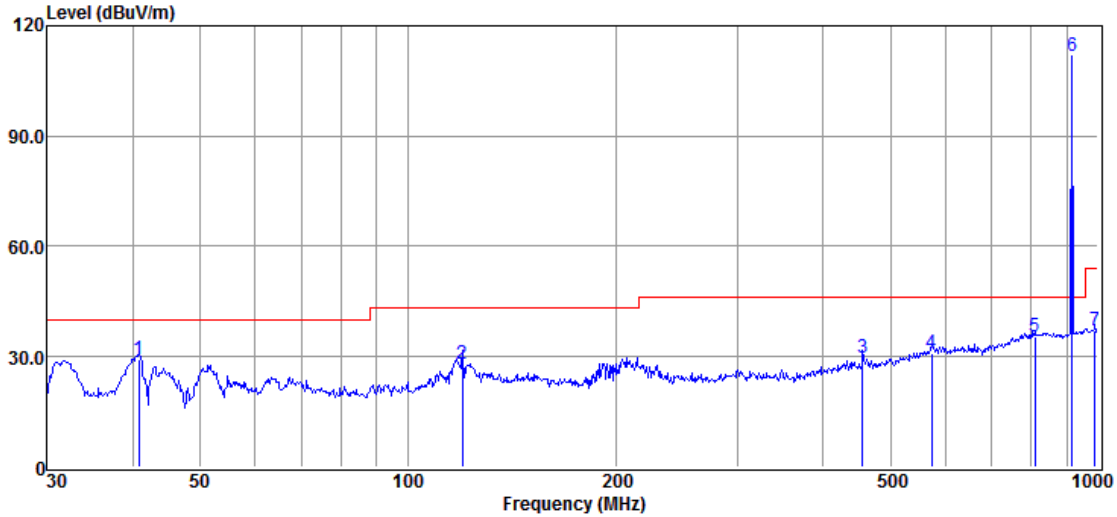

Horizontal:

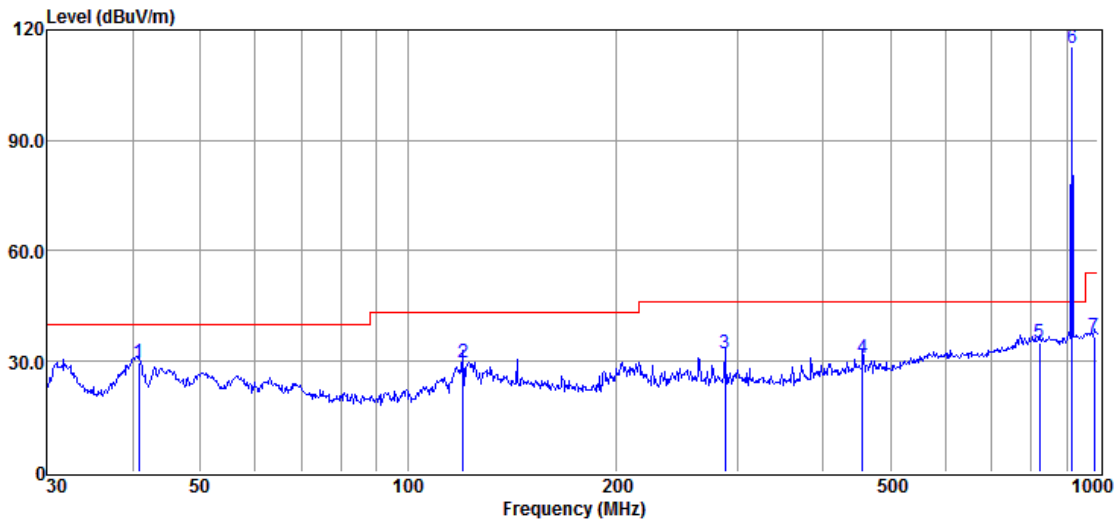



Above 1GHz:

Test mode: 125KHz Channel

Test Channel: 902.3MHz

Mark	Frequency (MHz)	Reading (dBuV)	Factor (dB)	Emission (dBuV/m)	Limit (dBuV/m)	Over Limit (dB)	Detector	Polarization
1	1804.6	36.21	6.25	42.46	54	-11.54	peak	Horizontal
2	2706.9	36.89	10.67	47.56	54	-6.44	peak	Horizontal
3	3609.2	37.51	14.37	51.88	54	-2.12	peak	Horizontal
4	1804.6	32.54	6.25	38.79	54	-15.21	peak	Vertical
5	2706.9	35.25	10.67	45.92	54	-8.08	peak	Vertical
6	3609.2	34.12	14.37	48.49	54	-5.51	peak	Vertical

Test mode: 125KHz Channel

Test Channel: 908.5MHz

Mark	Frequency (MHz)	Reading (dBuV)	Factor (dB)	Emission (dBuV/m)	Limit (dBuV/m)	Over Limit (dB)	Detector	Polarization
1	1817	37.14	6.25	43.39	54	-10.61	peak	Horizontal
2	2725.5	35.22	10.67	45.89	54	-8.11	peak	Horizontal
3	3634	36.89	14.37	51.26	54	-2.74	peak	Horizontal
4	1817	31.27	6.25	37.52	54	-16.48	peak	Vertical
5	2725.5	34.85	10.67	45.52	54	-8.48	peak	Vertical
6	3634	33.65	14.37	48.02	54	-5.98	peak	Vertical

Test mode: 125KHz Channel

Test Channel: 914.9MHz

Mark	Frequency (MHz)	Reading (dBuV)	Factor (dB)	Emission (dBuV/m)	Limit (dBuV/m)	Over Limit (dB)	Detector	Polarization
1	1829.8	37.45	6.25	43.7	54	-10.3	peak	Horizontal
2	2744.7	35.23	10.67	45.9	54	-8.1	peak	Horizontal
3	3659.6	36.98	14.37	51.35	54	-2.65	peak	Horizontal
4	1829.8	31.54	6.25	37.79	54	-16.21	peak	Vertical
5	2744.7	34.25	10.67	44.92	54	-9.08	peak	Vertical
6	3659.6	33.98	14.37	48.35	54	-5.65	peak	Vertical

Remark: 1) Emission = Receiver Reading + Factor

2) Factor = Antenna Factor + Cable Loss + Pre-amplifier Factor.

3) If the Peak value below the AV Limit, the AV test doesn't perform for this submission.



Test mode: 500KHz Channel

Item	Freq.	Read Level	Antenna Factor	Preamp Factor	Cable Loss	Result Level	Limit Line	Over Limit	Detector	Polarization
(Mark)	(MHz)	(dB μ V)	(dB/m)	(dB)	(dB)	(dB μ V/m)	(dB μ V/m)	(dB)		
1	40.70	43.83	13.64	28.80	0.97	29.64	40.00	-10.36	QP	Horizontal
2	119.86	45.25	11.80	28.60	1.31	29.76	43.50	-13.74	QP	Horizontal
3	200.69	42.80	10.76	28.10	1.80	27.26	43.50	-16.24	QP	Horizontal
4	287.99	44.19	12.44	27.90	2.15	30.88	46.00	-15.12	QP	Horizontal
5	804.60	37.33	23.55	29.09	3.85	35.64	46.00	-10.36	QP	Horizontal
6	982.62	36.42	24.03	28.80	4.24	35.89	54.00	-18.11	QP	Horizontal
1	40.70	43.06	13.64	28.80	0.97	28.87	40.00	-11.13	QP	VERTICAL
2	119.86	44.91	11.80	28.60	1.31	29.42	43.50	-14.08	QP	VERTICAL
3	203.52	43.78	10.59	28.10	1.82	28.09	43.50	-15.41	QP	VERTICAL
4	455.91	37.89	16.58	29.10	2.76	28.13	46.00	-17.87	QP	VERTICAL
5	818.83	36.19	23.69	29.07	3.87	34.68	46.00	-11.32	QP	VERTICAL
6	955.44	37.08	24.13	28.85	4.21	36.57	46.00	-9.43	QP	VERTICAL

Result Level = Read Level + Antenna Factor + Cable loss - Preamp Factor

Below is the plot of worst case on the lowest channel 903MHz:
Vertical:

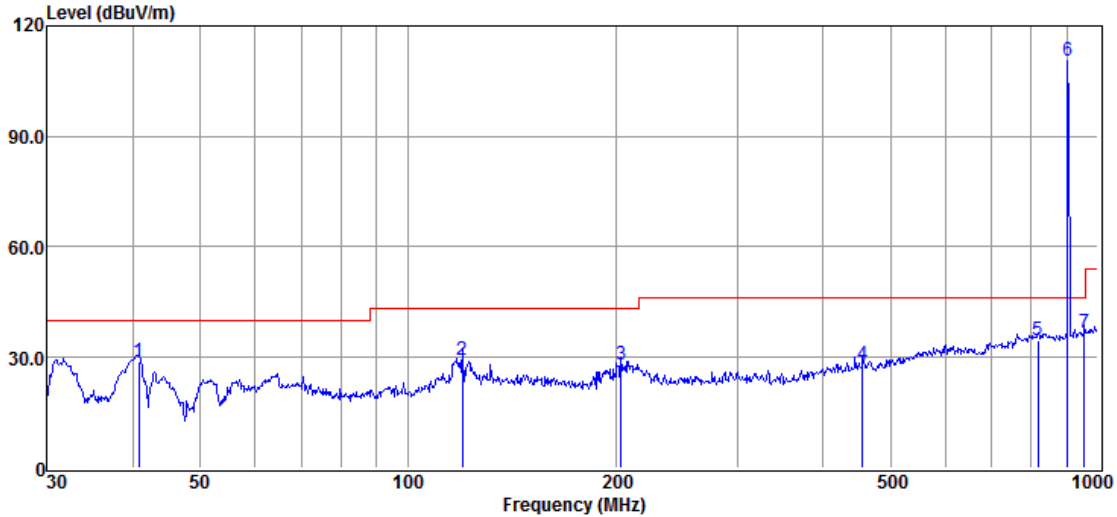

Horizontal:

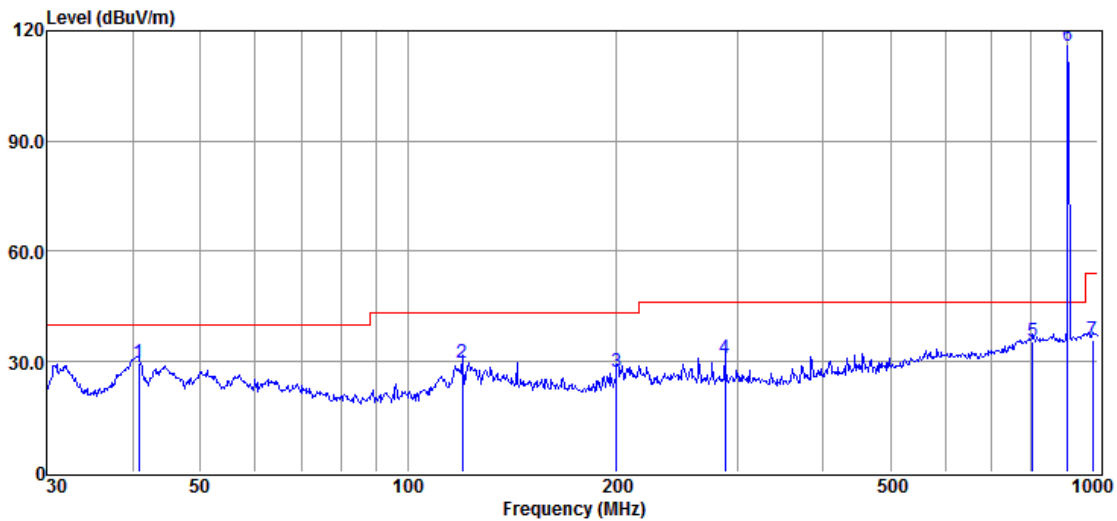

Test mode: 500KHz Channel

Test Channel: 903MHz

Mark	Frequency (MHz)	Reading (dBuV)	Factor (dB)	Emission (dBuV/m)	Limit (dBuV/m)	Over Limit (dB)	Detector	Polarization
1	1806	35.23	6.25	41.48	54	-12.52	peak	Horizontal
2	2709	37.45	10.67	48.12	54	-5.88	peak	Horizontal
3	3612	36.21	14.37	50.58	54	-3.42	peak	Horizontal
4	1806	31.25	6.25	37.5	54	-16.5	peak	Vertical
5	2709	34.87	10.67	45.54	54	-8.46	peak	Vertical
6	3612	33.46	14.37	47.83	54	-6.17	peak	Vertical

Test mode: 500KHz Channel

Test Channel: 907.8MHz

Mark	Frequency (MHz)	Reading (dBuV)	Factor (dB)	Emission (dBuV/m)	Limit (dBuV/m)	Over Limit (dB)	Detector	Polarization
1	1815.6	36.22	6.25	42.47	54	-11.53	peak	Horizontal
2	2723.4	36.54	10.67	47.21	54	-6.79	peak	Horizontal
3	3631.2	35.21	14.37	49.58	54	-4.42	peak	Horizontal
4	1815.6	32.54	6.25	38.79	54	-15.21	peak	Vertical
5	2723.4	34.23	10.67	44.9	54	-9.1	peak	Vertical
6	3631.2	34.78	14.37	49.15	54	-4.85	peak	Vertical

Test mode: 500KHz Channel

Test Channel: 914.2MHz

Mark	Frequency (MHz)	Reading (dBuV)	Factor (dB)	Emission (dBuV/m)	Limit (dBuV/m)	Over Limit (dB)	Detector	Polarization
1	1828.4	36.78	6.25	43.03	54	-10.97	peak	Horizontal
2	2742.6	36.51	10.67	47.18	54	-6.82	peak	Horizontal
3	3656.8	35.97	14.37	50.34	54	-3.66	peak	Horizontal
4	1828.4	32.54	6.25	38.79	54	-15.21	peak	Vertical
5	2742.6	34.92	10.67	45.59	54	-8.41	peak	Vertical
6	3656.8	34.57	14.37	48.94	54	-5.06	peak	Vertical

- Remark: 1) Emission = Receiver Reading + Factor
 2) Factor = Antenna Factor + Cable Loss + Pre-amplifier Factor.
 3) If the Peak value below the AV Limit, the AV test doesn't perform for this submission.

6.12.2 Radiated Band edge

Test Mode: 125KHz Channel

Test Channel: 902.3MHz

MK.	Frequency (MHz)	Reading (dBuV/m)	Antenna Factor (dB/m)	Preamp Factor (dB)	Cable Loss (dB)	Result (dBuV/m)	Limit (dBuV/m)	Over Limit (dB)	Detector	Polarization
1	902.00	43.14	22.96	28.94	4.12	41.28	46.00	-4.72	QP	Horizontal
2	902.37	117.53	22.96	28.94	4.12	115.67	46.00	69.67	Peak	Horizontal
1	902.00	43.97	22.96	28.94	4.12	42.11	46.00	-3.89	QP	Vertical
2	902.35	112.41	22.96	28.94	4.12	110.55	46.00	64.55	Peak	Vertical

Horizontal

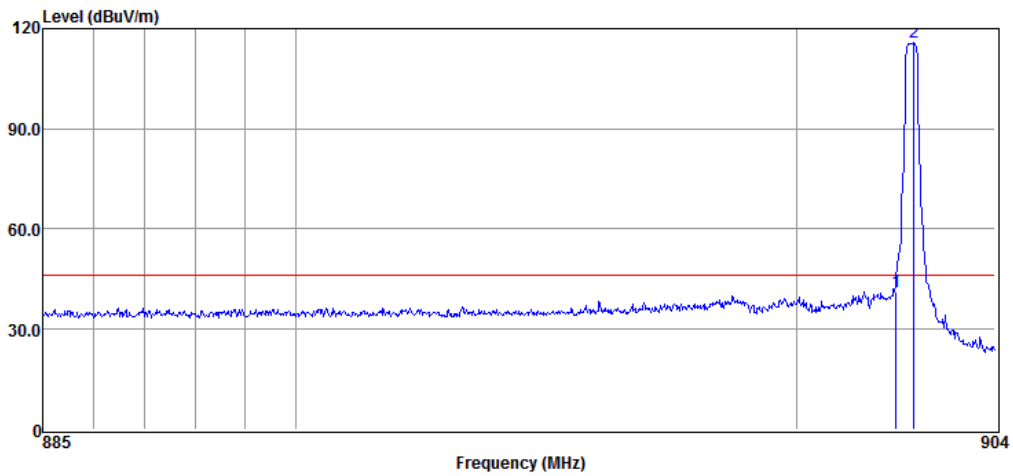

Vertical

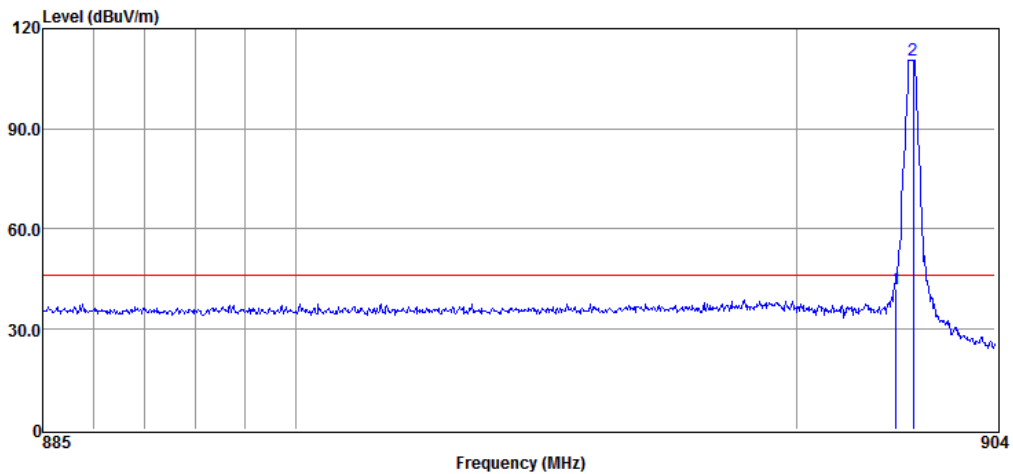

Test Mode: 125KHz Channel

Test Channel: 914.9MHz

MK.	Frequency (MHz)	Reading (dBuV/m)	Antenna Factor (dB/m)	Preamp Factor (dB)	Cable Loss (dB)	Result (dBuV/m)	Limit (dBuV/m)	Over Limit (dB)	Detector	Polarization
1	914.84	116.67	23.31	28.92	4.13	115.19	46.00	69.19	Peak	Horizontal
2	928.00	38.39	23.40	28.89	4.15	37.05	46.00	-8.95	QP	Horizontal
1	914.91	113.05	23.31	28.92	4.13	111.57	46.00	65.57	Peak	Vertical
2	928.00	37.95	23.40	28.89	4.15	36.61	46.00	-9.39	QP	Vertical

Horizontal

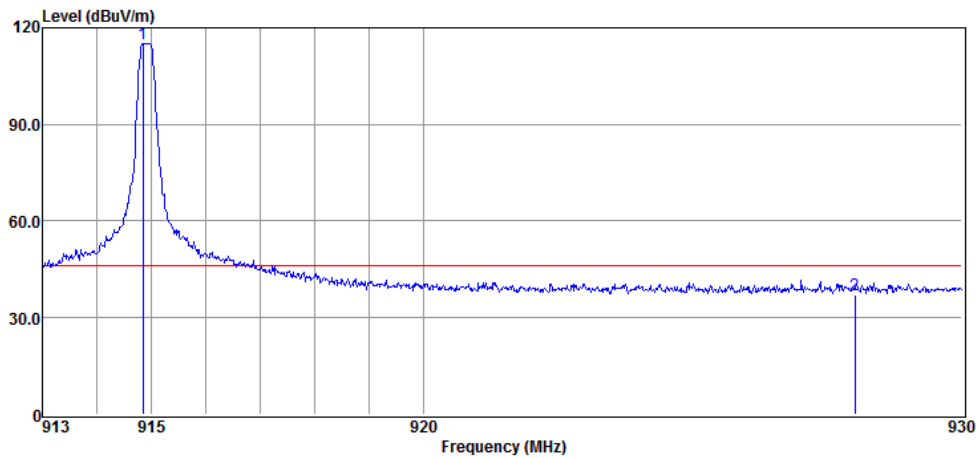

Vertical

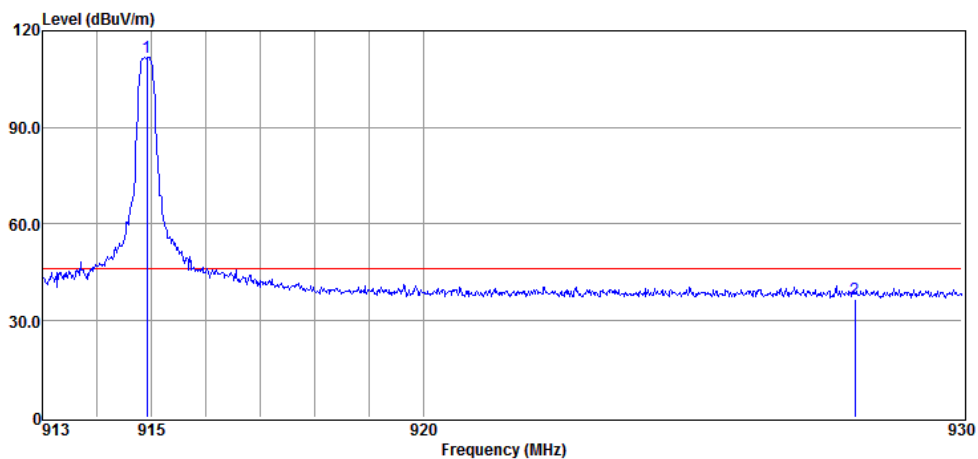

Test Mode: 500KHz Channel

Test Channel: 903MHz

MK.	Frequency (MHz)	Reading (dBuV/m)	Antenna Factor (dB/m)	Preamp Factor (dB)	Cable Loss (dB)	Result (dBuV/m)	Limit (dBuV/m)	Over Limit (dB)	Detector	Polarization
1	902.00	45.26	22.96	28.94	4.12	43.40	46.00	-2.60	QP	Horizontal
2	902.76	117.51	22.96	28.94	4.12	115.65	46.00	69.65	Peak	Horizontal
1	902.00	43.97	22.96	28.94	4.12	42.11	46.00	-3.89	QP	Vertical
2	902.82	112.64	22.96	28.94	4.12	110.78	46.00	64.78	Peak	Vertical

Horizontal

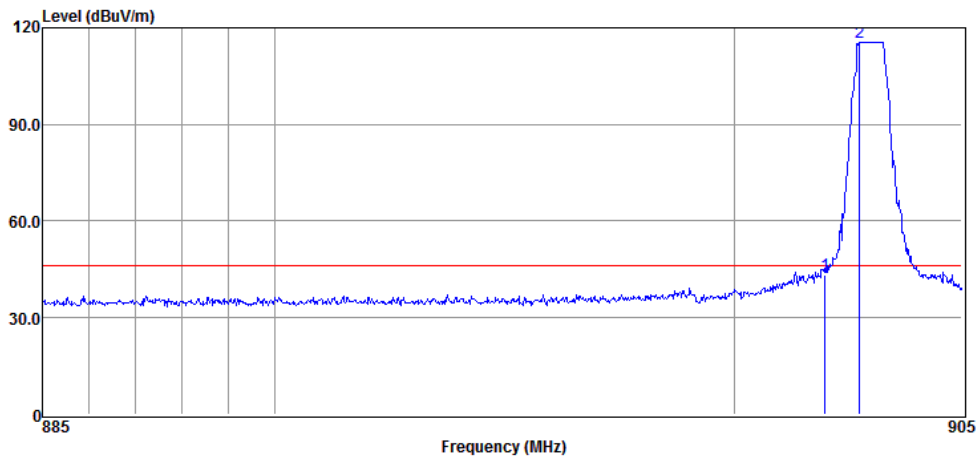

Vertical

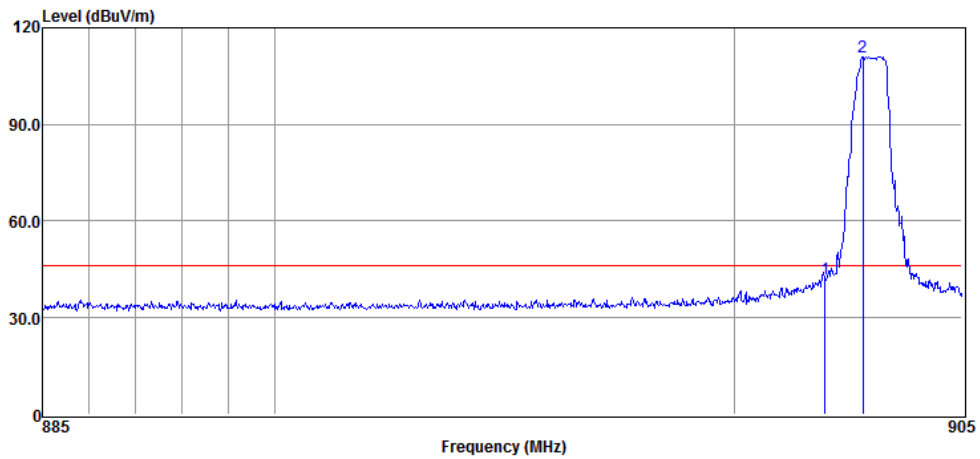

Test Mode: 500KHz Channel

Test Channel: 914.2MHz

MK.	Frequency (MHz)	Reading (dBuV/m)	Antenna Factor (dB/m)	Preamp Factor (dB)	Cable Loss (dB)	Result (dBuV/m)	Limit (dBuV/m)	Over Limit (dB)	Detector	Polarization
1	913.98	116.70	23.22	28.92	4.13	115.13	46.00	69.13	Peak	Horizontal
2	928.00	37.86	23.40	28.89	4.15	36.52	46.00	-9.48	QP	Horizontal
1	914.45	112.88	23.22	28.92	4.13	111.31	46.00	65.31	Peak	Vertical
2	928.00	37.77	23.40	28.89	4.15	36.43	46.00	-9.57	QP	Vertical

Horizontal

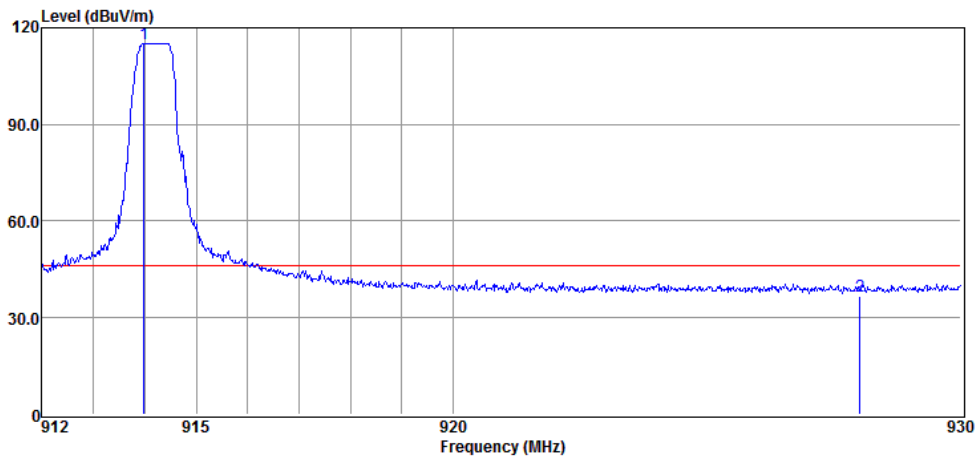

Vertical

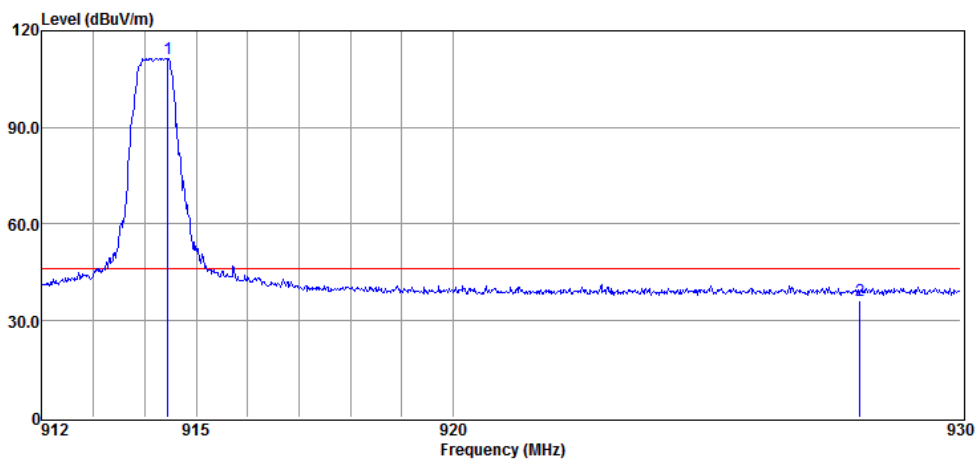



- Remark: 1). Test Level = Receiver Reading + Antenna Factor + Cable Loss- Preampifier Factor
2). If the Peak value below the AV Limit, the AV test doesn't perform for this submission.

All frequencies within the "Restricted bands" have been evaluated to compliance. Except as shown in paragraph of this section, only spurious emissions are permitted in any of the frequency bands listed below:

a. FCC Part 15, Subpart C Section 15.205 Restricted bands of operation.

MHz	MHz	MHz	GHz
0.090 - 0.110	16.42 - 16.423	399.9 - 410	4.5 - 5.15
¹ 0.495 - 0.505	16.69475 - 16.69525	608 - 614	5.35 - 5.46
2.1735 - 2.1905	16.80425 - 16.80475	960 - 1240	7.25 - 7.75
4.125 - 4.128	25.5 - 25.67	1300 - 1427	8.025 - 8.5
4.17725 - 4.17775	37.5 - 38.25	1435 - 1626.5	9.0 - 9.2
4.20725 - 4.20775	73 - 74.6	1645.5 - 1646.5	9.3 - 9.5
6.215 - 6.218	74.8 - 75.2	1660 - 1710	10.5 - 12.7
6.26775 - 6.26825	108 - 121.94	1718.8 - 1722.2	13.25 - 13.4
6.31175 - 6.31225	123 - 138	2200 - 2300	14.47 - 14.5
8.291 - 8.294	149.9 - 150.05	2310 - 2390	15.35 - 16.2
8.362 - 8.366	156.52475 - 156.52525	2483.5 - 2500	17.7 - 21.4
8.37625 - 8.38675	156.7 - 156.9	2655 - 2900	22.01 - 23.12
8.41425 - 8.41475	162.0125 - 167.17	3260 - 3267	23.6 - 24.0
12.29 - 12.293	167.72 - 173.2	3332 - 3339	31.2 - 31.8
12.51975 - 12.52025	240 - 285	3345.8 - 3358	36.43 - 36.5
12.57675 - 12.57725	322 - 335.4	3600 - 4400	
13.36 - 13.41			

6.13 99% Occupied Bandwidth

Test Configuration:

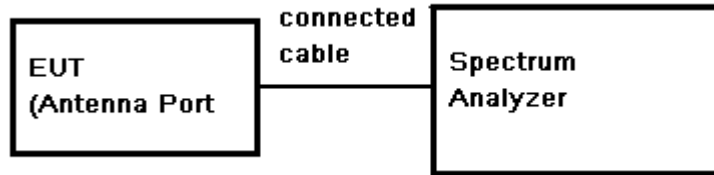

Test Procedure:

- 1) Remove the antenna from the EUT and then connect a low RF cable from the antenna port to the spectrum;
- 2) Set the spectrum analyzer: Span = approximately 1.5 to 5 times the OBW, centred on the test channel;
- 3) Set the spectrum analyzer: RBW = 1% to 5% of the OBW. VBW \geq 3 x RBW. Sweep = auto; Detector Function = Peak. Trace = Max Hold.
- 4) Mark the peak frequency and 99% bandwidth points.

Test Date:

Test Mode	Channel (MHz)	Bandwidth (KHz)
125KHz	902.3	126.00
	908.5	126.00
	914.9	125.60
500KHz	903	682.69
	907.8	682.69
	914.2	677.88

Test plot as follows:

125KHz Channel	Test Channel: 902.3MHz
----------------	------------------------

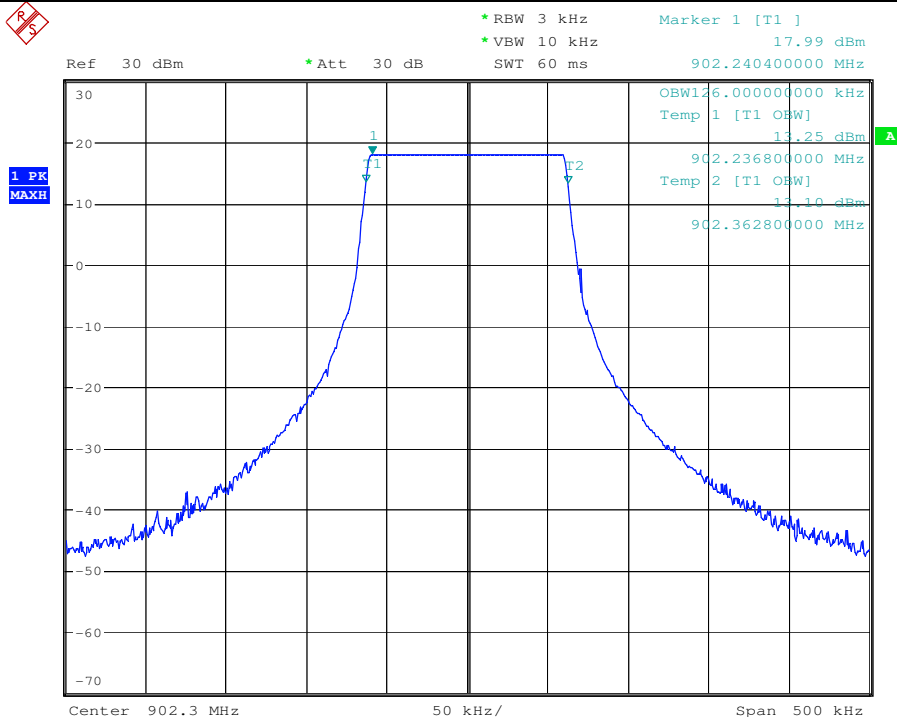

125KHz Channel	Test Channel: 908.5MHz
----------------	------------------------

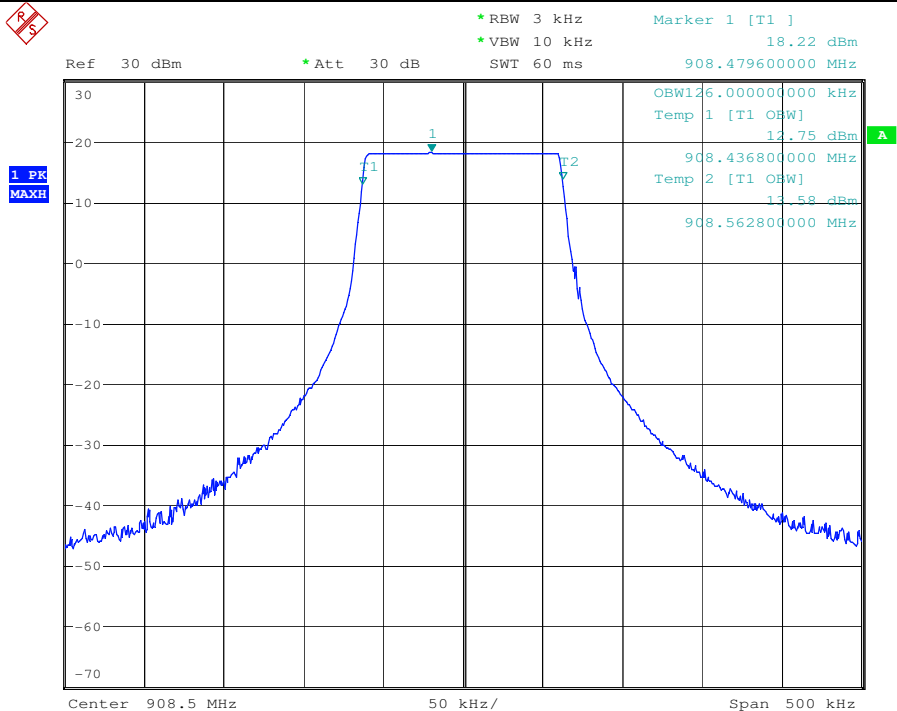

125KHz Channel **Test Channel: 914.9MHz**

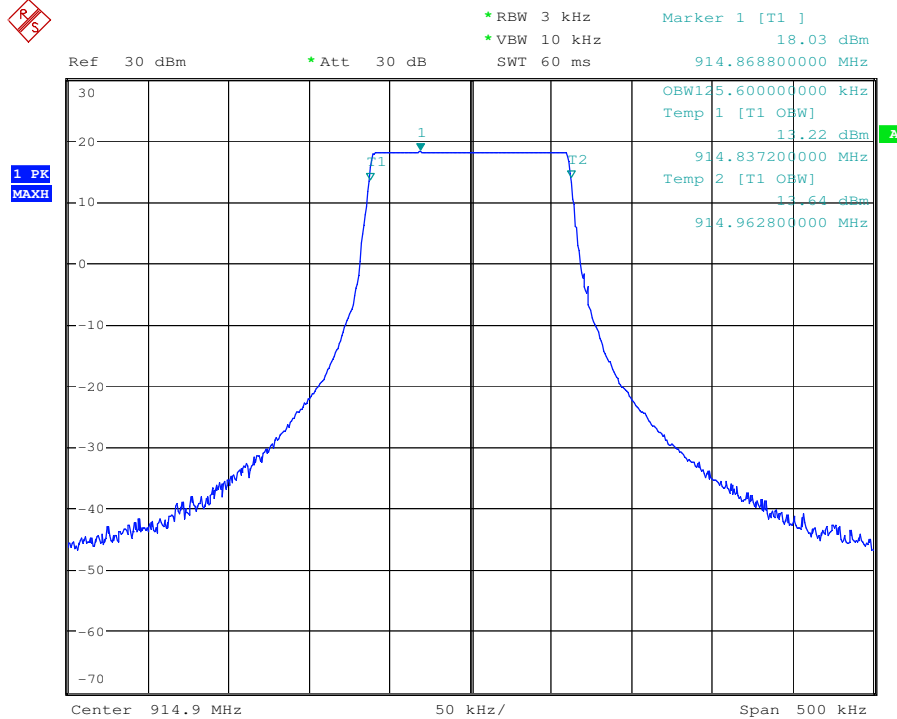

500KHz Channel **Test Channel: 903MHz**

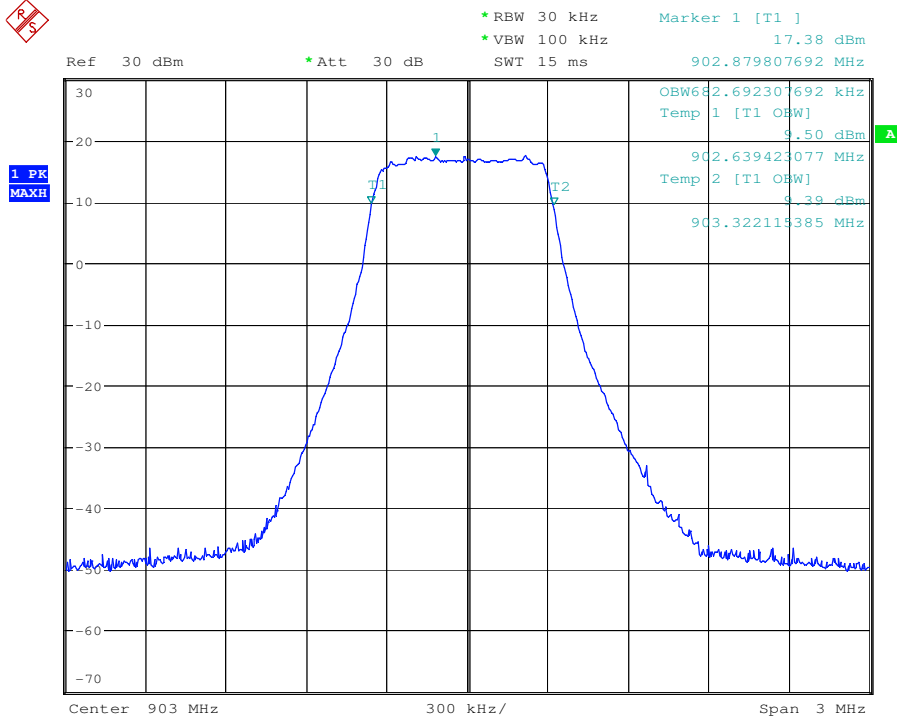

500KHz Channel Test Channel: 907.8MHz

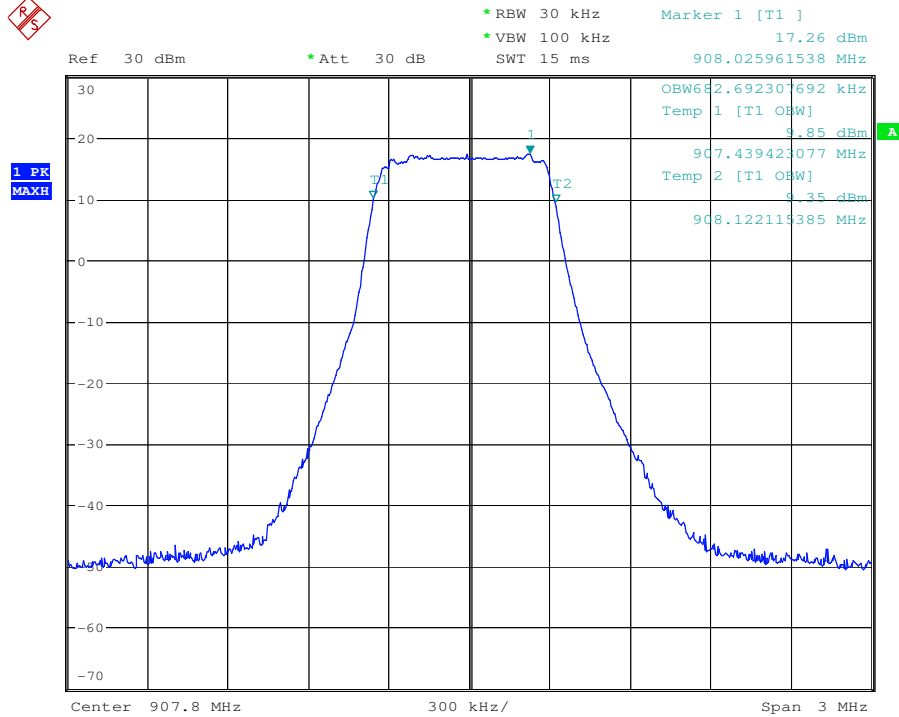

500KHz Channel Test Channel: 914.2MHz

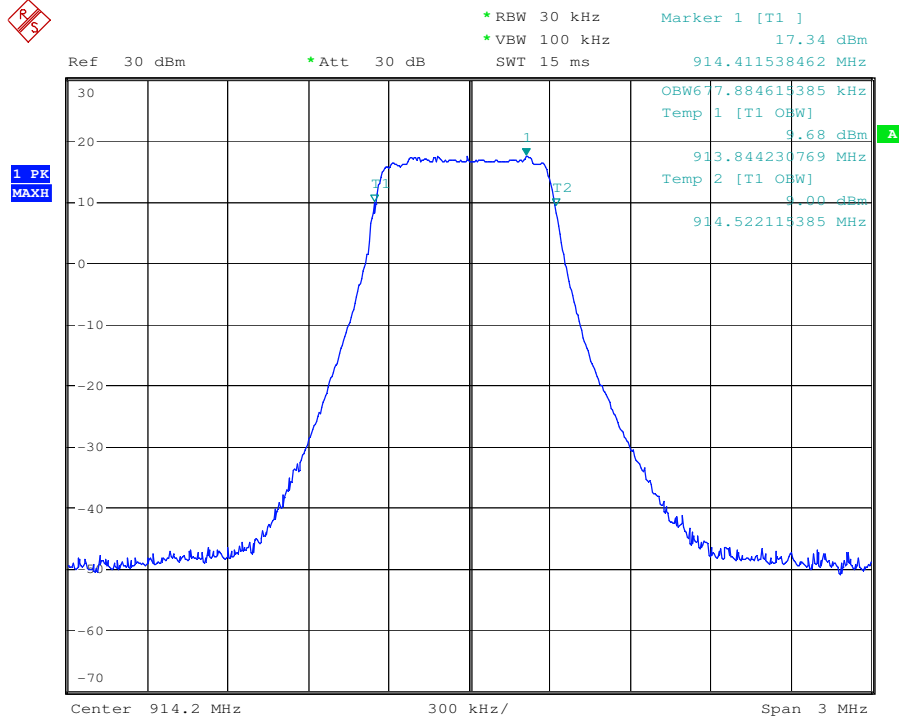



7 Test Setup Photographs

Refer to the < CMWX1ZZABZ _Test Setup photos-FCC>.

8 EUT Constructional Details

Refer to the < CMWX1ZZABZ Photos >

--End of the Report--