



Shenzhen Zhengdaxinwei Communication Equipment Co.,Ltd

APPROVAL

CUSTOMER: _____

WiFiaerial-2

DESCRIPTION: _____

ZDXV-0.81*85MM/IPEX First generation terminal

MODEL NO: _____

CUS PART NO: _____

2023-10-16

D A T E: _____

ZDXV Sign by sample

ENGINEERING DEPARTMENT	Q C DEPARTMENT	SALES DEPARTMENT
Li Qiannan	Deng zhengfang	Ding Yonggang

The customer presents the sample signature

ENGINEERING DEPARTMENT	Q C DEPARTMENT	SALES DEPARTMENT

※ Customer confirmation sample attached:

The name of the company: Shenzhen Zhengda Xinwei Communication Equipment Co., LTD
 The company address: No.486, Zhangbei Road, Zhangbei Community, Longcheng Street, Longgang District, Shenzhen
 The company web site: www.zdxwtx.com Contact phone number: 0755-28839286
 fax: 0755-89909291 mailbox: zds@zidasv.net

1. Product size

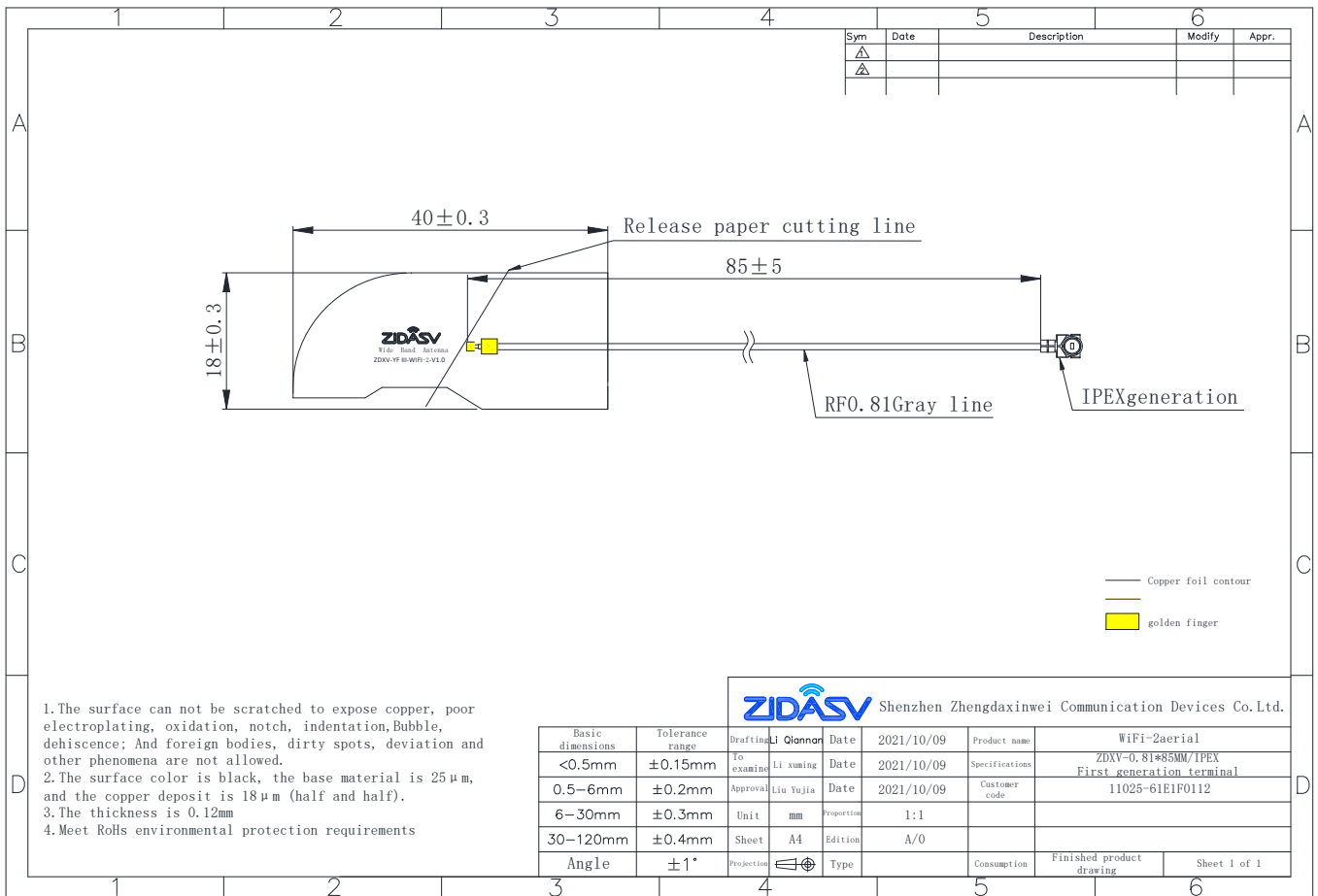

2. Electrical Specification :

Model	WiFi built-in aerial
Main Technical Specifications	
Frequency Range (MHz)	2400-2500MHz 5150-5850MHz
VSWR	≤ 2.5
Input Impedance (Ω)	50
Polarization Type	linear

Connector Type	IPEX
Working Humidity	20-80%
Working Temperature	-40°C~+85°C
Storage Temperature	-40°C~+85°C

2-1. Frequency Band:

Frequency Band	MHz
WIFI	2400-2500MHz 5150-5850MHz

2-2. Impedance

50 ohm nominal

2-3. VSWR

2-3-1.Measurement frequency points and VSWR value

Frequency (Unit MHz)	2400	2500	5150	5850
VSWR	1.5	1.7	1.2	1.3

2-3-2. VSWR

Frequency Band(MHz)	2400	2500	5150	5850
2-3-3. Typical Value:	≤2.5	≤2.5	≤2.5	≤2.5

<p>2-3-4 Measuring Method</p>	<ol style="list-style-type: none"> 1. A 50 Ω coaxial cable is connected to the Antenna. Then this cable is connected to a network analyzer to measure the VSWR. 2. Keeping this jig away from metal at least 20 cm
<p>2-3-5 Picture</p>	

2-4. Efficiency and Gain

- measuring instrument: microwave darkroom, network analyzer, standard antenna
- description of microwave darkroom:

This is the microwave darkroom set up by our company in Shenzhen. The microwave darkroom belongs to a set of far-field measurement system. The size of the darkroom is 7.0m x4.0m x3.0m, and the quiet zone size is 15cm x15cm x15cm.



图 1. 微波暗室内部仪器设置 r.4

Figure. 1 shows the connection diagram of the instrument setting and network analyzer in the microwave darkroom. The distance from the transmitting antenna to the antenna to be tested (AUT) is 1.35M. The antenna to be tested is placed on the rotating platform. By controlling the rotation angle of the turntable, the antenna to be tested can be measured roughly and accurately.

Place the antenna to be tested on the rotating table, and measure the 360 degree field strength data of each plane (ZY plane and ZX plane). Then, the antenna to be tested is replaced with a standard dipole antenna, and its 360 degree field strength data is measured as the conversion gain standard value. The gain value and pattern of the antenna to be tested can be obtained through the conversion of equation 1.

$$G_{AUT} = G_{stand} + P_{AUT} - P_{stand}$$

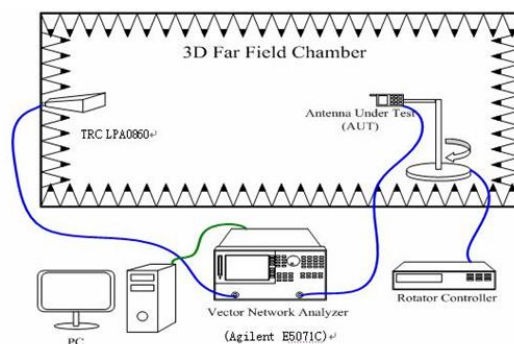
G_{AUT} : Gain of AUT
 G_{stand} : Gain of Standard Gain Antenna
 P_{AUT} : Measured Power of AUT
 P_{stand} : Measured Power of Standard Gain Antenna

2-4-1 Efficiency and Gain

Frequency (MHz)	Gain (dBi)	Efficiency(%)	Frequency (MHz)	Gain (dBi)	Efficiency(%)
2400	2.97	38.94	5150	2.44	30.81
2410	3.21	40.65	5200	1.63	28.35
2420	2.75	35.80	5250	2.30	33.19
2430	3.10	38.44	5300	2.47	31.60
2440	3.69	45.24	5350	3.83	39.78
2450	3.66	46.70	5400	4.97	50.53
2460	3.48	46.69	5450	4.79	49.17
2470	3.69	47.88	5500	4.87	48.91
2480	3.67	47.40	5550	4.50	46.83
2490	3.46	45.70	5600	3.97	45.28
2500	3.52	47.76	5650	3.19	45.29
			5700	3.19	47.27
			5750	3.59	45.96
			5800	4.08	48.39
			5850	3.27	39.51

2-5 OTA directional diagram

2-5-1 Antenna test scene diagram

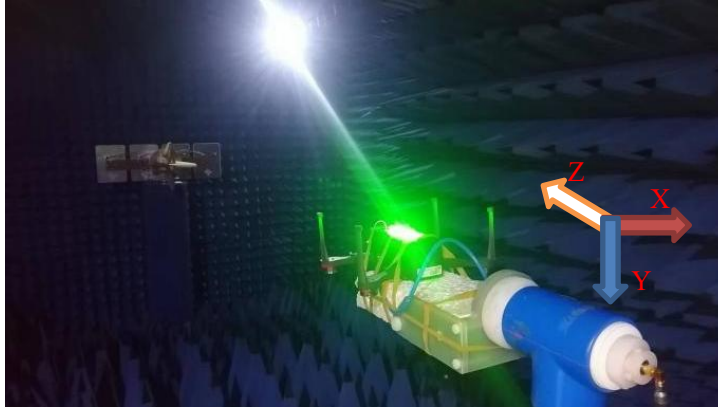

2-5-2 OTA directional diagram

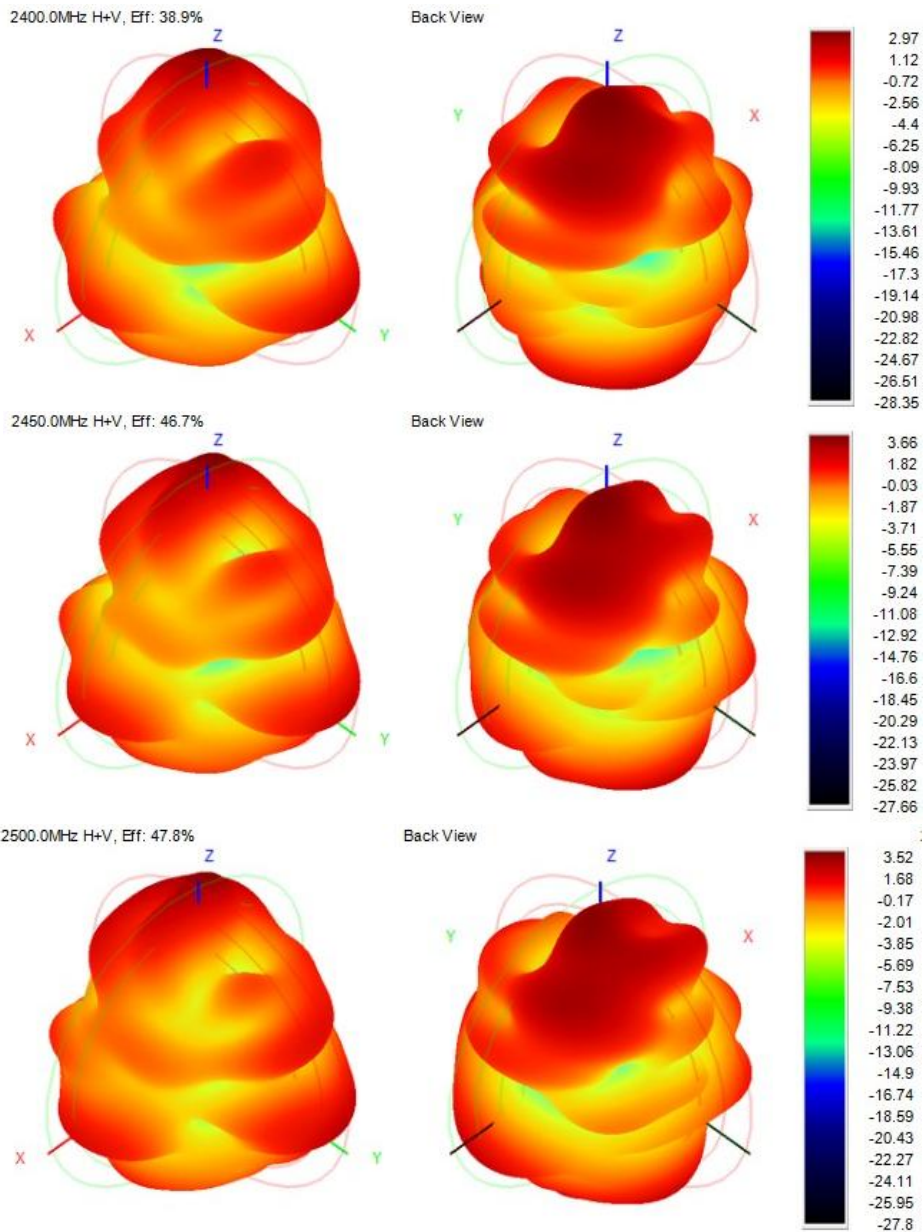

5150.0MHz H+V, Eff: 30.8%

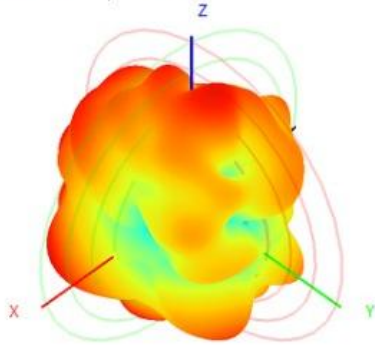

Back View

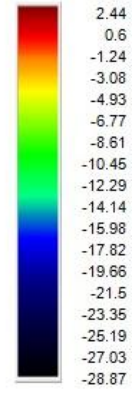
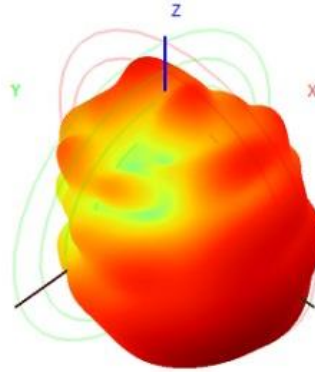

5500.0MHz H+V, Eff: 48.9%

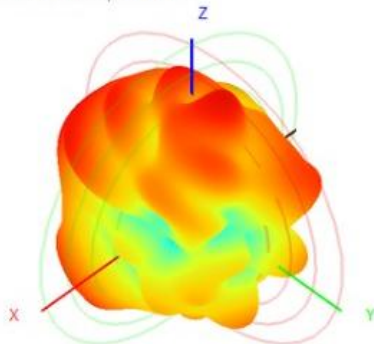

Back View

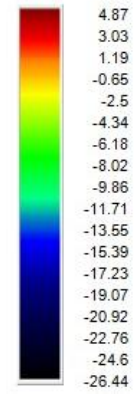
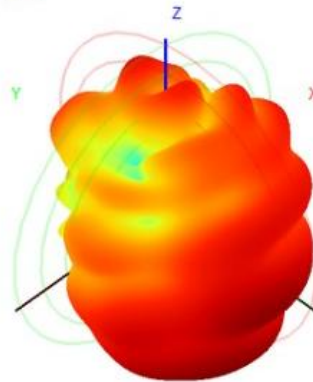

5850.0MHz H+V, Eff: 39.5%

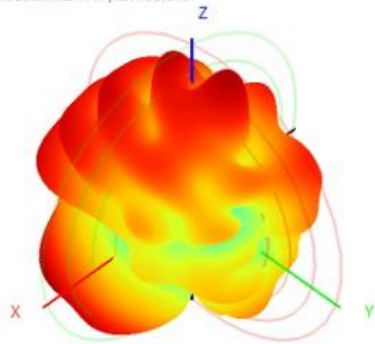

Back View

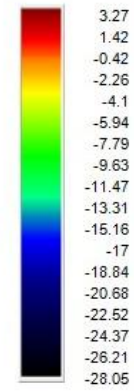
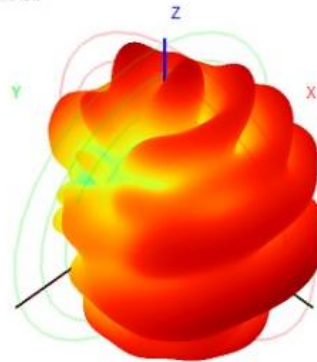

Thanks!