

**ELECTROMAGNETIC EMISSIONS COMPLIANCE REPORT
FCC PART 15 SUBPART C REQUIREMENT**

OF

Headphone

**Model No.: iKF King, iKF-King 2, iKF K2, iKF Show, iKF-Play, iKF-Titan,
iKF-Kids, iKF T1, iKF T2, iKF T3, iKF T4**

Trademark: N/A

FCC ID: 2A9CM-01

Report No.: E01A22110261F00102

Issue Date: November 17, 2022

Prepared for

Dongguan Awu Technology Co., Ltd.

**Room 315-317, Building 4, No. 86, Hongtu Road, Nancheng Street,
Dongguan City, Guangdong Province**

Prepared by

Dong Guan Anci Electronic Technology Co., Ltd.

**1-2 Floor, Building A, No.11, Headquarters 2 Road, Songshan, Lake Hi-tech
Industrial Development Zone, Dongguan City, Guangdong Pr., China..**

**This report shall not be reproduced, except in full, without the written approval of
Dong Guan Anci Electronic Technology Co., Ltd.**

VERIFICATION OF COMPLIANCE

Applicant:	Dongguan Awu Technology Co., Ltd. Room 315-317, Building 4, No. 86, Hongtu Road, Nancheng Street, Dongguan City, Guangdong Province
Manufacturer:	Dongguan Oumu Technology Co., Ltd. Room 312-314, Building D, Nanxin Industry International, Nancheng District, Dongguan City, Guangdong Province
Product Description:	Headphone
Trade Mark:	iKF
Model Number:	iKF King, iKF-King 2, iKF K2, iKF Show, iKF-Play, iKF-Titan, iKF-Kids, iKF T1, iKF T2, iKF T3, iKF T4 (All models are identical except model name, We choose model iKF King to do all tests.)

We hereby certify that:

The above equipment was tested by Dong Guan Anci Electronic Technology Co., Ltd. The test data, data evaluation, test procedures, and equipment configurations shown in this report were made in accordance with the procedures given in ANSI C63.10-2013 and the energy emitted by the sample EUT tested as described in this report is in compliance with conducted and radiated emission limits of FCC Rules Part 15.247(2022).

Date of Test : November 09, 2022 to November 15, 2022

Prepared by :

Duke Li / Editor

Reviewer & Authorized
Signer :

Tiger Xu / Supervisor



Modified Information

Version	Summary	Revision Date	Report No.
Ver.1.0	Original Report	/	E01A22110261F00102

Table of Contents

1.	GENERAL INFORMATION	6
1.1	PRODUCT DESCRIPTION	6
1.2	TEST METHODOLOGY	6
2.	TEST FACILITY	7
3.	DESCRIPTION OF TEST MODES	8
4.	SUMMARY OF TEST RESULTS.....	10
6DB BANDWIDTH MEASUREMENT		10
5.	TEST SYSTEM UNCERTAINTY.....	11
6.	CONDUCTED EMISSIONS TEST.....	12
6.1	MEASUREMENT PROCEDURE:	12
6.2	TEST SET-UP (BLOCK DIAGRAM OF CONFIGURATION).....	12
6.3	MEASUREMENT EQUIPMENT USED:	12
6.4	CONDUCTED EMISSION LIMIT	12
6.5	MEASUREMENT RESULT:	13
6.5	CONDUCTED MEASUREMENT PHOTOS:	15
7.	RADIATED EMISSION TEST.....	16
7.1	MEASUREMENT PROCEDURE	16
7.2	TEST SET-UP (BLOCK DIAGRAM OF CONFIGURATION).....	18
7.3	MEASUREMENT EQUIPMENT USED:	19
7.4	RADIATED EMISSION LIMIT	20
7.5	MEASUREMENT RESULT	21
7.6	RADIATED MEASUREMENT PHOTOS:	27
8.	6DB BANDWIDTH MEASUREMENT	28
8.1	MEASUREMENT PROCEDURE	28
8.2	TEST SET-UP (BLOCK DIAGRAM OF CONFIGURATION).....	28
8.3	MEASUREMENT EQUIPMENT USED:	28
8.4	LIMIT	28
8.5	MEASUREMENT RESULTS:	28
9.	MAXIMUM PEAK OUTPUT POWER TEST	29
9.1	MEASUREMENT PROCEDURE	31
9.2	TEST SET-UP (BLOCK DIAGRAM OF CONFIGURATION).....	31
9.3	MEASUREMENT EQUIPMENT USED:	31
9.4	PEAK POWER OUTPUT LIMIT	31
9.5	MEASUREMENT RESULTS:.....	31
10.	POWER SPECTRAL DENSITY MEASUREMENT	32
10.1	MEASUREMENT PROCEDURE	34
10.2	TEST SET-UP (BLOCK DIAGRAM OF CONFIGURATION).....	34

10.3 MEASUREMENT EQUIPMENT USED: 34

10.4 MEASUREMENT PROCEDURE 34

10.5 MEASUREMENT RESULTS: 35

11. BAND EDGE TEST 38

 11.1 MEASUREMENT PROCEDURE 38

 11.2 TEST SET-UP (BLOCK DIAGRAM OF CONFIGURATION) 39

 11.3 MEASUREMENT EQUIPMENT USED: 39

 11.4 MEASUREMENT RESULTS: 40

12. ANTENNA REQUIREMENT 45

 12.2 RESULT 45

13. PHOTOS OF EUT 46

1. GENERAL INFORMATION

1.1 Product Description

Characteristics	Description
Product Name	Headphone
Model number	iKF King
Input Rating	DC 5V, DC 3.7V
Power Supply	DC 5V from adapter and battery 3.7V
Kind of Device	Bluetooth Ver.5.3 BLE
Modulation	GFSK
Operating Frequency Range	2402-2480MHz
Number of Channels	40
Transmit Power Max(PK)	-0.93dBm(0.0008W)
Antenna Type	Chip Antenna
Antenna Gain	2.39dBi
Date of Sample Received	November 08, 2022

1.2 Test Methodology

All the test program has follow FCC new test procedure KDB 558074 D01 DTS Meas Guidance v05 and in accordance with the procedures given in ANSI C63.10-2013.

1. Test Facility

Site Description

Name of Firm : Dong Guan Anci Electronic Technology Co., Ltd.
Site Location : 1-2 Floor, Building A, No.11, Headquarters 2 Road, Songshan,
Lake Hi-tech Industrial Development Zone, Dongguan City,
Guangdong Pr., China.

2. Description of test modes

The EUT has been tested under its typical operating condition and fully-charged battery for EUT tested alone. Pre-defined engineering program for regulatory testing used to control the EUT for staying in continuous transmitting. Only the worst case data were reported.

For Radiated: The EUT's antenna was pre-tested under the following modes:

Test Mode	Description
Mode A	X-Y axis
Mode B	Y-Z axis
Mode C	X-Z axis

From the above modes, the worst case was found in Mode C. Therefore only the test data of the mode was recorded in this report.

The EUT has been associated with peripherals pursuant to ANSI C63.10-2013 and configuration operated in a manner tended to maximize its emission characteristics in a typical application. Frequency range investigated: radiation (9 KHz to the 10th harmonics of the highest fundamental frequency or to 40 GHz, whichever is lower).

Configuration of Tested System

EUT

Equipment Used in Tested System

Item	Equipment	Trademark	Model No.	FCC ID	Note
1.	Headphone	N/A	IKF King	2A9CM-01	EUT
2.	Adapter	MI	Model:MDY-08-EH Input: AC 100-240V, 50/60Hz Output: DC 5V/2.5A,DC 9/2A	N/A	Support EUT

The EUT has been tested under TX operating condition.

Channel List:

Channel	Frequency (MHz)	Channel	Frequency (MHz)	Channel	Frequency (MHz)
00	2402	14	2430	28	2458
01	2404	15	2432	29	2460
02	2406	16	2434	30	2462
03	2408	17	2436	31	2464
04	2410	18	2438	32	2466
05	2412	19	2440	33	2468
06	2414	20	2442	34	2470
07	2416	21	2444	35	2472
08	2418	22	2446	36	2474
09	2420	23	2448	37	2476
10	2422	24	2450	38	2478
11	2424	25	2452	39	2480
12	2426	26	2454		
13	2428	27	2456		

Note:

1. Test of channel was included the lowest 2402MHz, middle 2440MHz and highest frequency 2480MHz in highest data rate and to perform the test, then record on this report.

3. Summary of Test Results

FCC Rules	Description Of Test	Result
§15.207	AC Power Conducted Emission	Compliant
§15.247(d),§15.209	Radiated Emission	Compliant
§15.247(a)(2)	6dB Bandwidth Measurement	Compliant
§15.247(b)	MAXIMUM PEAK OUTPUT POWER TEST	Compliant
§15.247(e)	Power Spectral Density Measurement	Compliant
§15.247(d)	Band EDGE test	Compliant
§15.203	Antenna Requirement	Compliant
Remark: According to FCC OET KDB 558074, the report use radiated measurements in the restricted frequency bands. In addition, the radiated test is also performed to ensure the emissions emanating from the device cabinet also comply with the applicable limits.		

4. TEST SYSTEM UNCERTAINTY

The following measurement uncertainty levels have been estimated for tests performed on the apparatus:

Parameter	Uncertainty
Radio Frequency	$\pm 1 \times 10^{-5}$
Maximum Peak Output Power Test	$\pm 1.0\text{dB}$
Conducted Emissions Test	$\pm 2.0\text{dB}$
Radiated Emission Test	$\pm 2.0\text{dB}$
Power Density	$\pm 2.0\text{dB}$
Occupied Bandwidth Test	$\pm 1.0\text{dB}$
Band Edge Test	$\pm 3\text{dB}$
All emission, radiated	$\pm 3\text{dB}$
Antenna Port Emission	$\pm 3\text{dB}$
Temperature	$\pm 0.5^\circ\text{C}$
Humidity	$\pm 3\%$

Remark: The coverage Factor (k=2), and measurement Uncertainty for a level of Confidence of 95%

5. Conducted Emissions Test

6.1 Measurement Procedure:

1. The EUT was placed on a table, which is 0.8m above ground plane.
2. Maximum procedure was performed on the six highest emissions to ensure EUT compliance.
3. Repeat above procedures until all frequency measured was complete.

6.2 Test SET-UP (Block Diagram of Configuration)

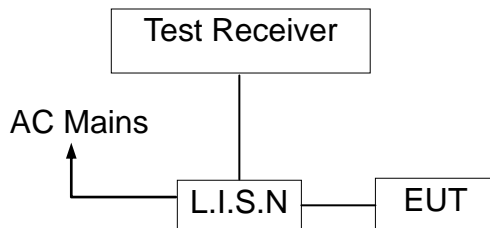

6.3 Measurement Equipment Used:

EQUIPMENT TYPE	MFR	MODEL NUMBER	SERIAL NUMBER	Calibrated until
L.I.S.N	SCHWARZBECK	NSLK 8127	8127-669	2023-05-12
10 db attenuator	JFW	50FP-010-H4	4360846-427-1	2023-05-12
RF Cable	N/A	N/A	2#	2023-05-12
EMI Test Receiver	ROHDE&SCHWARZ	ESCI	101358	2023-05-12
Test Software	Farad	EZ-EMC (Ver.ANCI-3A1)	N/A	N/A

6.4 Conducted Emission Limit

(7) Conducted Emission

Frequency(MHz)	Quasi-peak	Average
0.15-0.5	66-56	56-46
0.5-5.0	56	46
5.0-30.0	60	50

Note:

1. The lower limit shall apply at the transition frequencies
2. The limit decreases in line with the logarithm of the frequency in the range of 0.15 to 0.50MHz.

5.5 Measurement Result:

All the modulation modes were tested the data of the worst mode (BT Mode) are recorded in the following pages and the others modulation methods do not exceed the limits. Please refer to following pages.

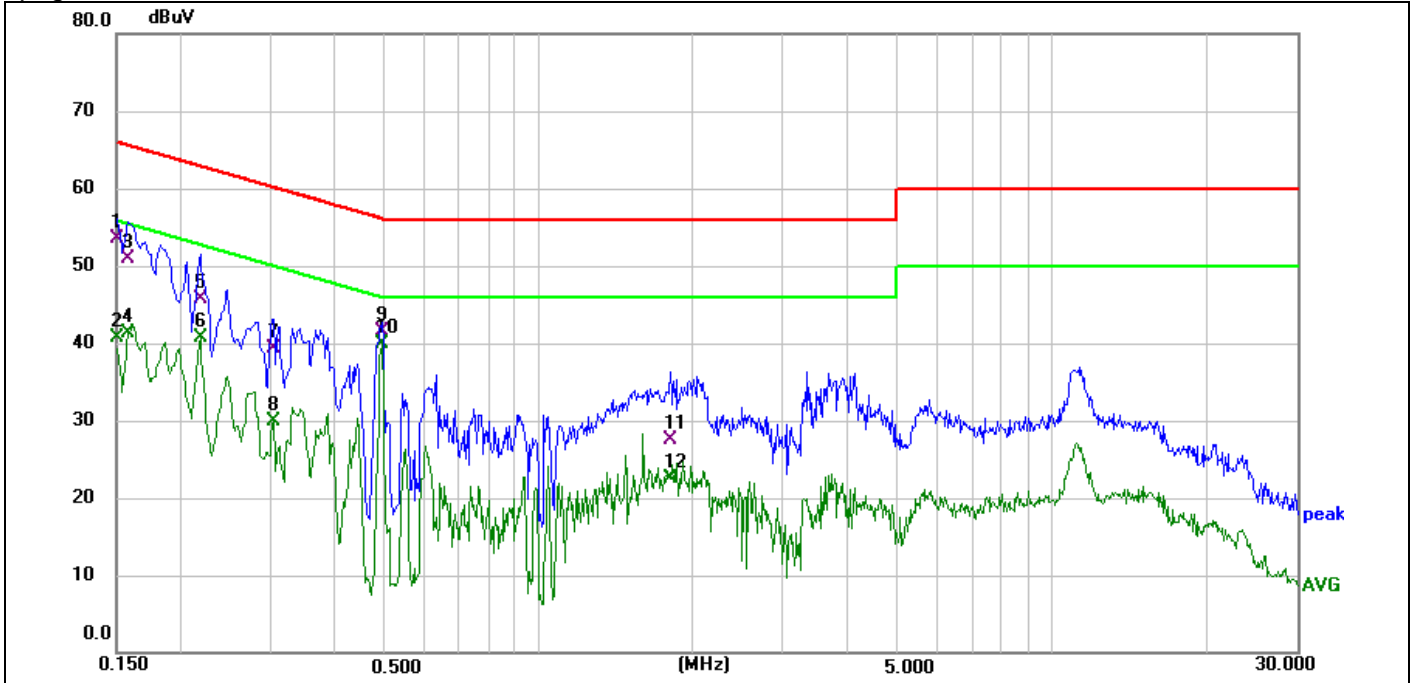

Site:	843	Phase:	IKF King	Temperature(C):	23.5(C)
Limit:	FCC PART 15C Conduction(QP)	Test Time:	2022-11-11	Humidity(%):	52.6%
EUT:	Headphone	Power Rating:	DC 5V From adapter	Test Engineer:	Sunshine
M/N.:	iKF King	Note:			
Mode:	BT mode				

No.	Frequency (MHz)	Reading Level(dBuV)	Factor (dB)	Measurement(dBuV)	Limit (dBuV)	Over (dB)	Detector	Comment
1	0.1500	43.63	9.96	53.59	66.00	-12.41	QP	
2	0.1500	30.78	9.96	40.74	56.00	-15.26	AVG	
3	0.1580	40.86	9.96	50.82	65.57	-14.75	QP	
4	0.1580	31.27	9.96	41.23	55.57	-14.34	AVG	
5	0.2180	35.87	9.93	45.80	62.89	-17.09	QP	
6	0.2180	30.69	9.93	40.62	52.89	-12.27	AVG	
7	0.3020	29.44	9.89	39.33	60.19	-20.86	QP	
8	0.3020	20.05	9.89	29.94	50.19	-20.25	AVG	
9	0.4940	31.79	9.69	41.48	56.10	-14.62	QP	
10	0.4940	30.18	9.69	39.87	46.10	-6.23	AVG	
11	1.8060	17.33	10.10	27.43	56.00	-28.57	QP	
12	1.8060	12.45	10.10	22.55	46.00	-23.45	AVG	

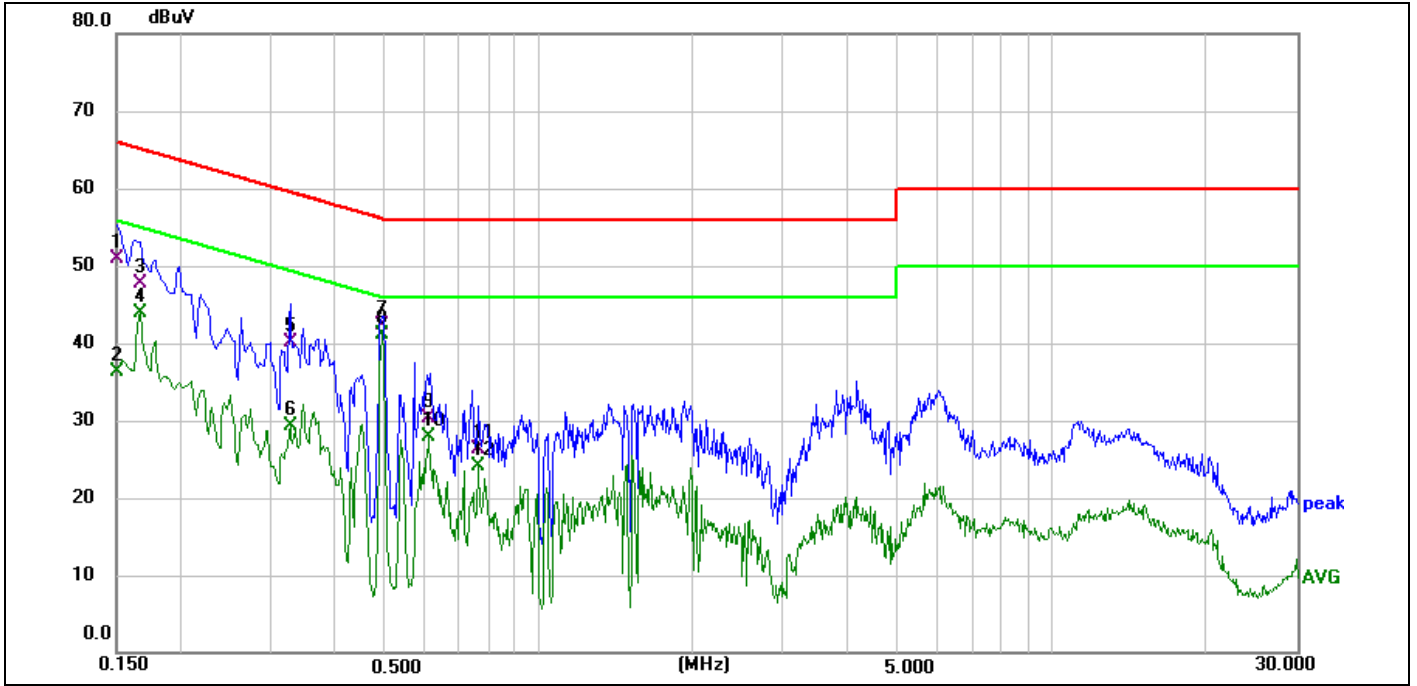

Site:	843	Phase:	N	Temperature(C):	23.5(C)
Limit:	FCC PART 15C Conduction(QP)	Test Time:		Humidity(%):	52.6%
EUT:	Headphone	Power Rating:		2022-11-11	
M/N.:	iKF King	Test Engineer:		DC 5V From adapter	
Mode:	BT mode			Sunshine	
Note:					

No.	Frequency (MHz)	Reading Level(dBuV)	Factor (dB)	Measurement(dBuV)	Limit (dBuV)	Over (dB)	Detector	Comment
1	0.1500	41.00	9.93	50.93	66.00	-15.07	QP	
2	0.1500	26.34	9.93	36.27	56.00	-19.73	AVG	
3	0.1660	37.72	9.92	47.64	65.16	-17.52	QP	
4	0.1660	33.91	9.92	43.83	55.16	-11.33	AVG	
5	0.3260	30.38	9.81	40.19	59.55	-19.36	QP	
6	0.3260	19.54	9.81	29.35	49.55	-20.20	AVG	
7	0.4954	32.58	9.66	42.24	56.08	-13.84	QP	
8	0.4954	31.43	9.66	41.09	46.08	-4.99	AVG	
9	0.6107	20.23	10.15	30.38	56.00	-25.62	QP	
10	0.6107	17.69	10.15	27.84	46.00	-18.16	AVG	
11	0.7631	16.24	10.16	26.40	56.00	-29.60	QP	
12	0.7631	13.95	10.16	24.11	46.00	-21.89	AVG	

6.5 Conducted Measurement Photos:



6. Radiated Emission Test

7.1 Measurement Procedure

1. The testing follows the guidelines in ANSI C63.10-2013.
2. Below 1000MHz, The EUT was placed on a turn table which is 0.8m above ground plane. And above 1000MHz, The EUT was placed on a styrofoam table which is 1.5m above ground plane.
3. The EUT was set 3 meters from the interference receiving antenna, which was mounted on the top of a variable height antenna tower.
4. The EUT was arranged to its worst case and then tune the Antenna tower (From 1m to 4m) and turntable (from 0 degree to 360 degrees) to find the maximum reading. A pre-amp and a high pass filter are used for the test in order to get better signal level.
5. For measurement below 1GHz, if the emission level of the EUT measured by the peak detector is 3dB lower than the applicable limit, the peak emission level will be reported. Otherwise, the emission measurement will be repeated using the quasi-peak detector and reported.
6. Final measurement (Above 1GHz): The frequency range will be divided into different sub ranges depending of the frequency range of the used horn antenna. The EMI Receiver set to peak and average mode and a resolution bandwidth of 1MHz. The measurement will be performed in horizontal and vertical polarization of the measuring antenna and while rotating the EUT in its vertical axis in the range of 0 degree to 360 degree in order to have the antenna inside the cone of radiation.
7. Test Procedure of measurement (For Above 1GHz):
 - 1) Monitor the frequency range at horizontal polarization and move the antenna over all sides of the EUT(if necessary move the EUT to another orthogonal axis).
 - 2) Change the antenna polarization and repeat 1) with vertical polarization.
 - 3) Make a hardcopy of the spectrum.
 - 4) Measure the frequency of the detected emissions with a lower span and resolution bandwidth to increase the accuracy and note the frequency value.
 - 5) Change the analyser mode to Clear/ Write and found the cone of emission.
 - 6) Rotate and move the EUT, so that the measuring distance can be enlarged to 3m and the antenna will be still inside the cone of emission.
 - 7) Measure the level of the detected frequency with the correct resolution bandwidth, with the antenna polarization and azimuth and the peak and average detector, which causes the maximum emission.
 - 8) Repeat steps 1) to 7) for the next antenna spot if the EUT is larger than the antenna beamwidth.

Use the following spectrum analyzer settings:

When spectrum scanned from 30MHz to 1GHz setting resolution bandwidth 120KHz and video bandwidth 300KHz:

EMI Test Receiver	Setting
Attenuation	Auto
RB	120KHz
VB	300KHz
Detector	QP
Trace	Max hold

When spectrum scanned above 1GHz setting resolution bandwidth 1MHz, video bandwidth 3MHz:

EMI Test Receiver	Setting
Attenuation	Auto
RB	1MHz
VB	3MHz
Detector	Peak
Trace	Max hold

When spectrum scanned above 1GHz setting resolution bandwidth 1MHz, video bandwidth 10Hz:

EMI Test Receiver	Setting
Attenuation	Auto
RB	1MHz
VB	10Hz
Detector	Average
Trace	Max hold

For Average Measurement:

VBW=10Hz, when duty cycle is no less than 98 percent.

$VBW \geq 1/T$, when duty cycle is less than 98 percent where T is the minimum transmission duration over which the transmitter is on and is transmitting at its maximum power control level for the tested mode of operation.

Band	Duty Cycle(%)	T(μ s)	1/T(KHz)	Average Correction Factor	VBW Setting
2402-2480	100	-	-	0	10Hz

7.2 Test SET-UP (Block Diagram of Configuration)

(A) Radiated Emission Test Set-Up, Frequency Below 30MHz

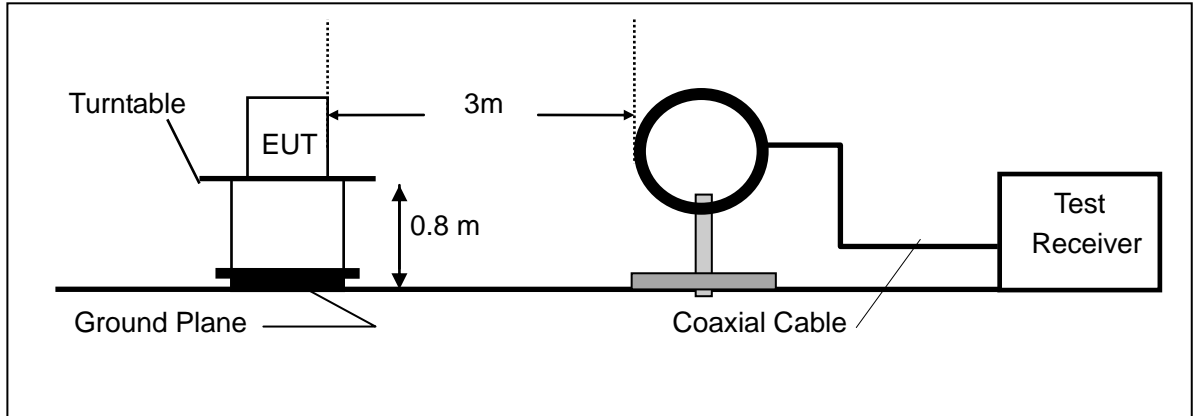

(B) Radiated Emission Test Set-Up, Frequency Below 1000MHz

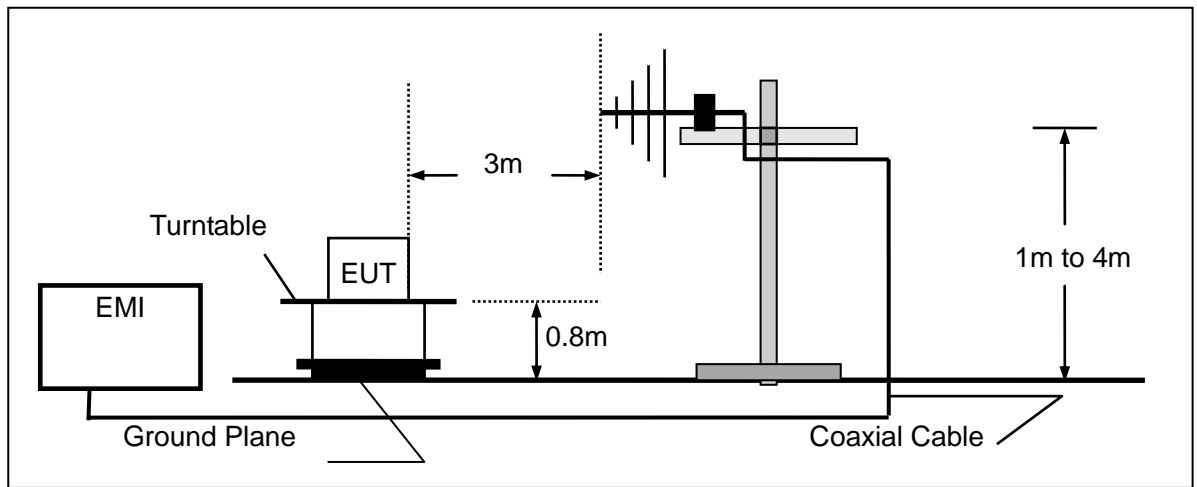

(C) Radiated Emission Test Set-Up, Frequency above 1000MHz

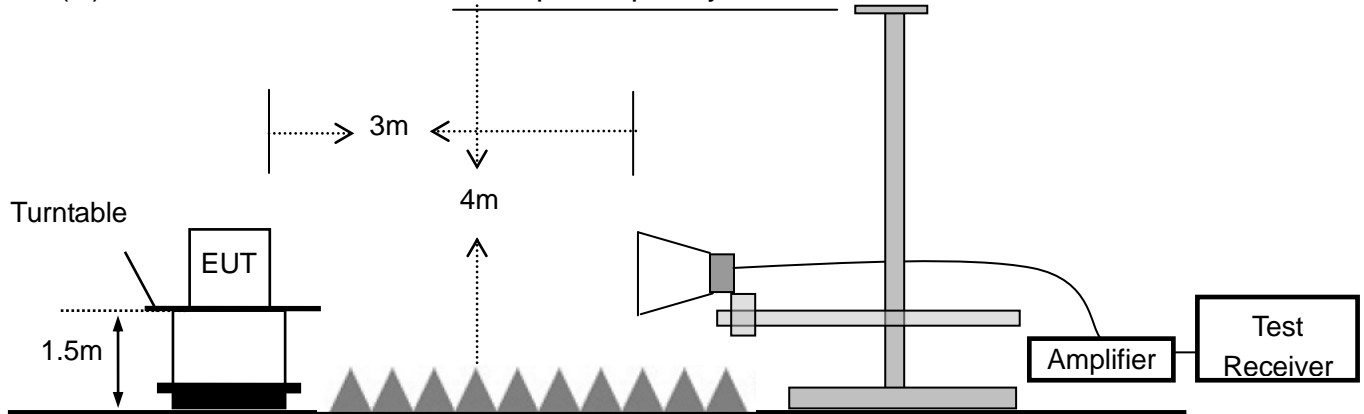

7.3 Measurement Equipment Used:

Item	Equipment	Manufacturer	Model No.	Serial No.	Calibrated until	Calibration interval
1.	EMI Test Receiver	Rohde & Schwarz	ESPI	100502	2022-11-12	1 year
2.	Pre-Amplifier	HP	8447D	2727A06172	2023-05-13	1 year
3.	Bilog Antenna	Schwarzbeck	VULB9163	VULB9163-588	2023-05-13	1 year
4.	Loop Antenna	Schwarzbeck	FMZB 1516	1516-141	2022-11-12	1 year
5.	Spectrum Analyzer	Rohde & Schwarz	FSV40	US40240623	2022-11-12	1 year
6.	Low noise Amplifiers	A-INFO	LA1018N4009	J101313052400 1	2023-05-13	1 year
7.	Horn antenna	A-INFO	LB-10180-SF	J203109061212 3	2023-05-13	1 year
8.	Broadband RF Power Amplifier	AEROFLEX	AEROFLEX10 0KHz-40GHz	J101313052400 1	2022-11-12	1 year
9.	DRG Horn Antenna	A.H.SYSTEMS	SAS-574	J203109061212 3	2022-11-12	1 year
10.	RF Cable	Gigalink Microwave	ZT40-2.92J-2. 92J-2m	N/A	2022-11-12	1 year
11.	RF Cable	Gigalink Microwave	ZT40-2.92J-2. 92J-0.3m	N/A	2022-11-12	1 year
12.	RF Cable	N/A	N/A	6#	2023-05-13	1 year
13.	RF Cable	N/A	N/A	1-1#	2023-05-13	1 year
14.	RF Cable	N/A	N/A	1-2#	2023-05-13	1 year
15.	RF Cable	N/A	N/A	7#	2023-05-13	1 year
16.	3m Semi-anechoic Chamber	chengyu	9m*6m*6m	N/A	2023-05-13	3 year
17.	Test Software	Farad	EZ-EMC Ver:ANCI-3A1	N/A	N/A	N/A

7.4 Radiated emission limit

The emissions from an intentional radiator shall not exceed the field strength levels specified in the following table 15.209(a):

Frequencies (MHz)	Field Strength (microrvolts/meter)	Measurement Distance (meters)
0.009~0.490	2400/F(KHz)	300
0.490~1.705	24000/F(KHz)	30
1.705~30.0	30	30
30~88	100	3
88~216	150	3
216~960	200	3
Above 960	500	3

15.205 Restricted bands of operation

MHz	MHz	MHz	GHz
0.090 - 0.110	16.42 - 16.423	399.9 - 410	4.5 - 5.15
¹ 0.495 - 0.505	16.69475 - 16.69525	608 - 614	5.35 - 5.46
2.1735 - 2.1905	16.80425 - 16.80475	960 - 1240	7.25 - 7.75
4.125 - 4.128	25.5 - 25.67	1300 - 1427	8.025 - 8.5
4.17725 - 4.17775	37.5 - 38.25	1435 - 1626.5	9.0 - 9.2
4.20725 - 4.20775	73 - 74.6	1645.5 - 1646.5	9.3 - 9.5
6.215 - 6.218	74.8 - 75.2	1660 - 1710	10.6 - 12.7
6.26775 - 6.26825	108 - 121.94	1718.8 - 1722.2	13.25 - 13.4
6.31175 - 6.31225	123 - 138	2200 - 2300	14.47 - 14.5
8.291 - 8.294	149.9 - 150.05	2310 - 2390	15.35 - 16.2
8.362 - 8.366	156.52475 - 156.52525	2483.5 - 2500	17.7 - 21.4
8.37625 - 8.38675	156.7 - 156.9	2690 - 2900	22.01 - 23.12
8.41425 - 8.41475	162.0125 - 167.17	3260 - 3267	23.6 - 24.0
12.29 - 12.293	167.72 - 173.2	3332 - 3339	31.2 - 31.8
12.51975 - 12.52025	240 - 285	3345.8 - 3358	36.43 - 36.5
12.57675 - 12.57725	322 - 335.4	3600 - 4400	(²)

Remark 1. Emission level in dBuV/m=20 log (uV/m)

- :
2. Measurement was performed at an antenna to the closed point of EUT distance of meters.
 3. Only spurious frequency is permitted to locate within the Restricted Bands specified in provision of § 15.205, and the emissions located in restricted bands also comply with 15.209 limit.

7.5 Measurement Result

Below 30MHz:

Operation Mode:	TX	Test Date :	2022-11-12
Frequency Range:	9KHz~30MHz	Temperature :	25°C
Test Result:	PASS	Humidity :	58 %
Measured Distance:	3m	Test By:	Best

Freq. (MHz)	Ant.Pol. H/V	Emission Level (dBuV/m)	Limit 3m (dBuV/m)	Over (dB)
--	--	--	--	--

Note: The low frequency, which started from 9KHz-30MHz, was pre-scanned and the result which was 20dB lower than the limit line per 15.31(o) was not reported.

Below 1000MHz:

Pass.

The data of the mode (GFSK 2402MHz) are recorded in the following pages.

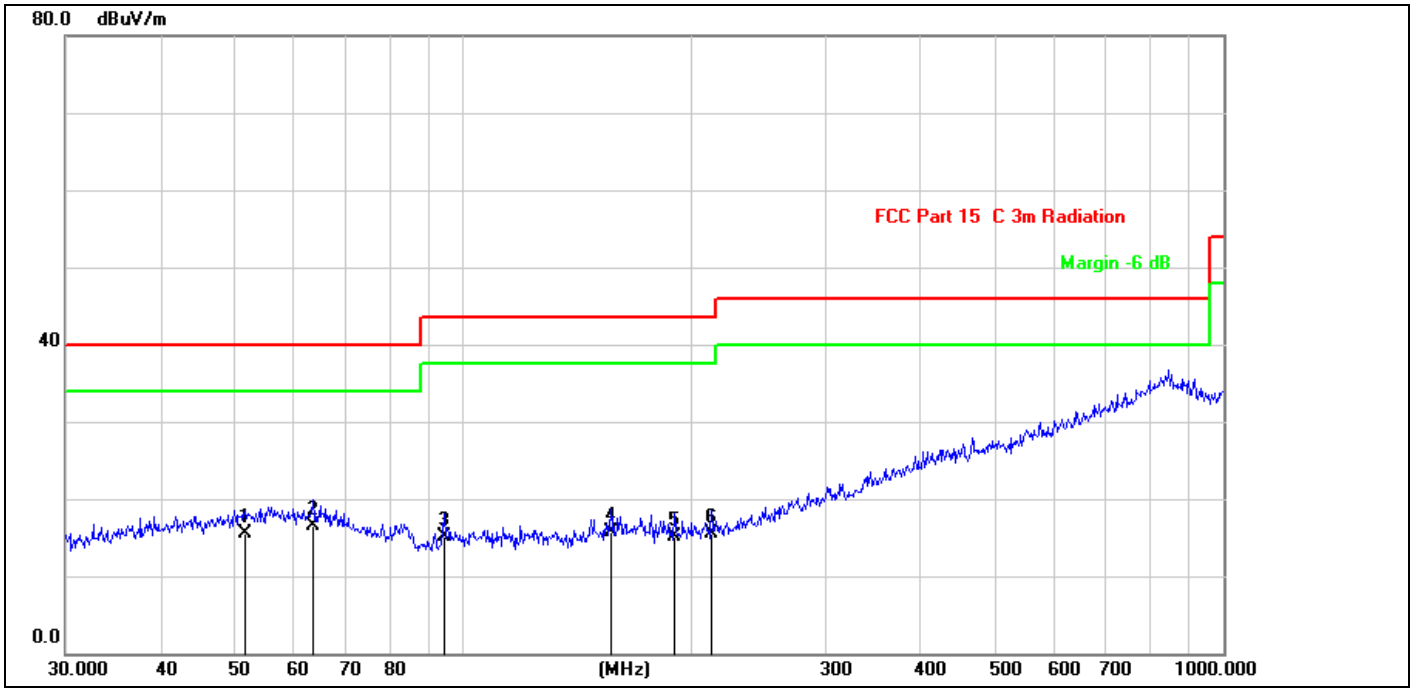

Site:	843.3	Antenna::	Vertical	Temperature(C):	26(C)
Limit:	FCC Part 15 C Conduction(QP)			Humidity(%):	54%
EUT:	Headphone	Test Time:	2022/11/12		
M/N.:	iKF King	Power Rating:	EUT DC 3.7V		
Mode:	TX2402	Test Engineer:	Sunshine		
Note:					

No.	Frequency (MHz)	Reading Level(dBuV)	Factor (dB)	Measurement(dBuV)	Limit (dBuV)	Over (dB)	Detector	Comment
1	51.6613	24.79	-9.32	15.47	40.00	-24.53	QP	
2	63.5356	25.50	-9.02	16.48	40.00	-23.52	QP	
3	94.4282	27.49	-12.39	15.10	43.50	-28.40	QP	
4	156.4576	27.19	-11.54	15.65	43.50	-27.85	QP	
5	189.7384	26.53	-11.37	15.16	43.50	-28.34	QP	
6	212.2693	26.56	-11.05	15.51	43.50	-27.99	QP	

*:Maximum data x:Over limit !:over margin

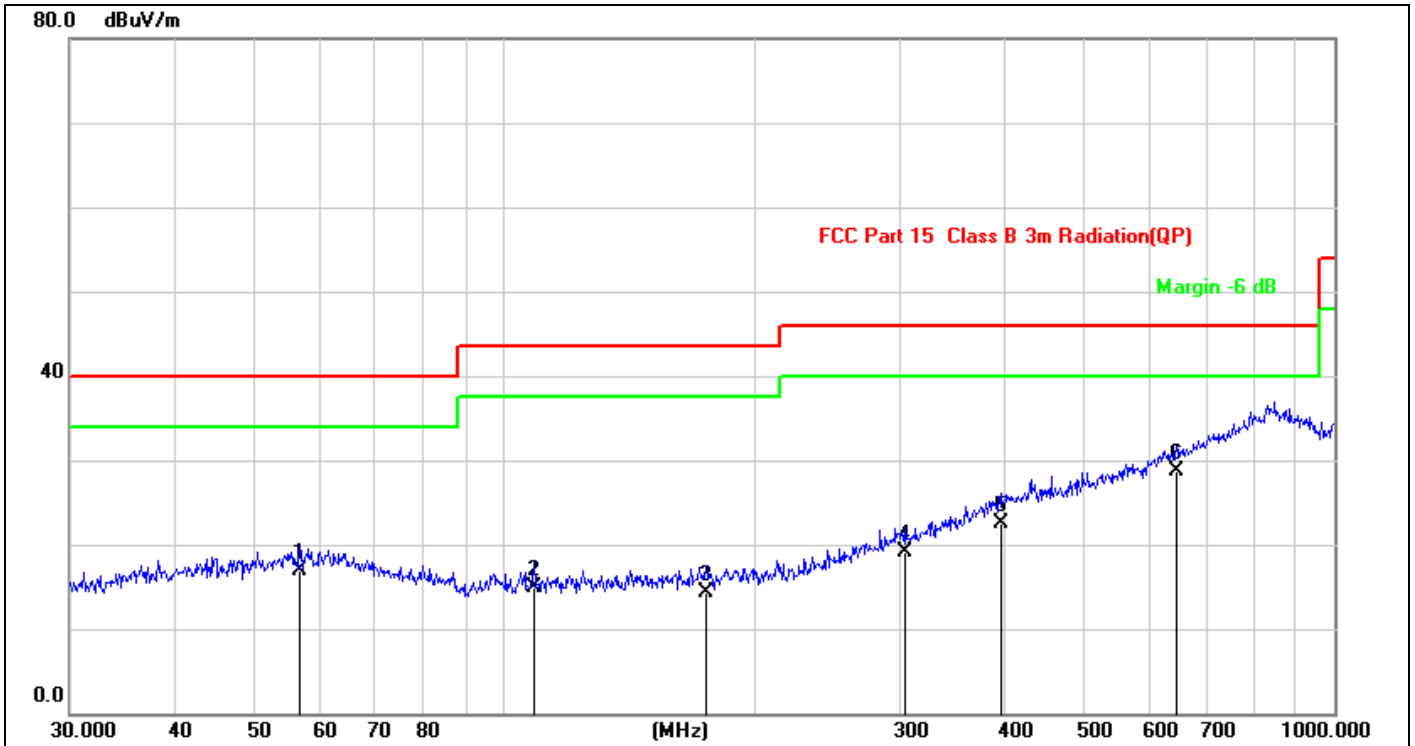

Site:	843.3	Antenna::	Horizonta	Temperature(C):	26(C)
Limit:	FCC Part 15 C Conduction(QP)	Test Time:	2022/11/12	Humidity(%):	60%
EUT:	Headphone	Power Rating:	EUT DC 3.7V	Test Engineer:	Sunshine
M/N.:	IKF King				
Mode:	TX2402				
Note:					

No.	Frequency (MHz)	Reading Level(dBuV)	Factor (dB)	Measure-ment(dBuV)	Limit (dBuV)	Over (dB)	Detector	Comment
1	56.7916	25.98	-9.14	16.84	40.00	-23.16	QP	
2	108.6470	26.50	-11.63	14.87	43.50	-28.63	QP	
3	175.0367	25.64	-11.24	14.40	43.50	-29.10	QP	
4	304.6099	25.83	-6.68	19.15	46.00	-26.85	QP	
5	394.8544	25.68	-3.15	22.53	46.00	-23.47	QP	
6 *	645.1195	26.41	2.22	28.63	46.00	-17.37	QP	

*:Maximum data x:Over limit !:over margin

Above 1000MHz~10th Harmonics:

Operation Mode: TX Mode (CH00: 2402MHz) Test Date : 2022-11-12
 Frequency Range: 1-25GHz Temperature : 25°C
 Test Result: PASS Humidity : 58 %
 Measured Distance: 3m Test By: Best

Freq. (MHz)	Ant. Pol.	Reading Level(dBuV/m)		Correct Factor dB	Emission Level(dBuV/m)		Limit 3m(dBuV/m)		Over(dB)	
		PK	AV		PK	AV	PK	AV	PK	AV
4804	V	94.02	75.55	-32.3	62.3	43.25	74	54	-11.7	-10.75
7206	V	97.4	76.72	-37.2	60.2	39.52	74	54	-13.8	-14.48
9608	V	97.45	78.05	-39.8	57.65	38.25	74	54	-16.35	-15.75
12010	V	96.13	77.08	-40.5	55.63	36.58	74	54	-18.37	-17.42
14412	V	97.72	77.89	-41.7	56.02	36.19	74	54	-17.98	-17.81
16814	V	95.69	76.11	-40	55.69	36.11	74	54	-18.31	-17.89
4804	H	94.01	74.72	-31.6	62.41	43.12	74	54	-11.59	-10.88
7206	H	95.52	75.63	-35.5	60.02	40.13	74	54	-13.98	-13.87
9608	H	95.95	76.55	-38.3	57.65	38.25	74	54	-16.35	-15.75
12010	H	95.13	76.02	-39	56.13	37.02	74	54	-17.87	-16.98
14412	H	98.02	79.14	-42	56.02	37.14	74	54	-17.98	-16.86
16814	H	94.62	75.71	-39.3	55.32	36.41	74	54	-18.68	-17.59

Other harmonics emissions are lower than 20dB below the allowable limit.

- Note:**
- (1) All Readings are Peak Value and AV.
 - (2) Emission Level= Reading Level+ Probe Factor +Cable Loss.
 - (3) The average measurement was not performed when the peak measured data under the limit of average detection.
 - (4) Measuring frequencies from 1GHz to 25GHz.

Operation Mode: TX Mode (CH19: 2440MHz) Test Date : 2022-11-12
 Frequency Range: 1-25GHz Temperature : 25°C
 Test Result: PASS Humidity : 58 %
 Measured Distance: 3m Test By: Best

Freq. (MHz)	Ant. Pol.	Reading Level(dBuV/m)		Correct Factor dB	Emission Level(dBuV/m)		Limit 3m(dBuV/m)		Margin(dB)	
		PK	AV		PK	AV	PK	AV	PK	AV
4880	V	96.31	76.53	-32.3	64.01	44.23	74	54	-9.99	-9.77
7320	V	97.56	79.45	-37.2	60.36	42.25	74	54	-13.64	-11.75
9760	V	97.97	79.21	-39.8	58.17	39.41	74	54	-15.83	-14.59
12200	V	96.82	78.09	-40.5	56.32	37.59	74	54	-17.68	-16.41
14640	V	97.22	78.26	-41	56.22	37.26	74	54	-17.78	-16.74
17080	V	96.81	77.15	-41.1	55.71	36.05	74	54	-18.29	-17.95
4880	H	95.29	75.75	-31.6	63.69	44.15	74	54	-10.31	-9.85
7320	H	95.81	76.61	-35.5	60.31	41.11	74	54	-13.69	-12.89
9760	H	96.36	77.35	-38.3	58.06	39.05	74	54	-15.94	-14.95
12200	H	95.25	76.58	-39	56.25	37.58	74	54	-17.75	-16.42
14640	H	97.36	78.47	-42	55.36	36.47	74	54	-18.64	-17.53
17080	H	97.28	78.08	-41.5	55.78	36.58	74	54	-18.22	-17.42

Other harmonics emissions are lower than 20dB below the allowable limit.

- Note:**
- (1) All Readings are Peak Value and AV.
 - (2) Emission Level= Reading Level+ Probe Factor +Cable Loss.
 - (3) The average measurement was not performed when the peak measured data under the limit of average detection.
 - (4) Measuring frequencies from 1GHz to 25GHz.

Operation Mode: TX Mode (CH39: 2480MHz) Test Date : 2022-11-12
 Frequency Range: 1-25GHz Temperature : 25°C
 Test Result: PASS Humidity : 58 %
 Measured Distance: 3m Test By: Best

Freq. (MHz)	Ant. Pol.	Reading Level(dBuV/m)		Correct Factor dB	Emission Level(dBuV/m)		Limit 3m(dBuV/m)		Margin(dB)	
		PK	AV		PK	AV	PK	AV	PK	AV
4960	V	95.82	76.46	-32.3	63.52	44.16	74	54	-10.48	-9.84
7440	V	97.34	78.22	-37.2	60.14	41.02	74	54	-13.86	-12.98
9920	V	98.12	79.38	-39.8	58.32	39.58	74	54	-15.68	-14.42
12400	V	96.75	78.02	-40.5	56.25	37.52	74	54	-17.75	-16.48
14880	V	96.14	77.47	-41	55.14	36.47	74	54	-18.86	-17.53
17360	V	96.33	77.57	-41.1	55.23	36.47	74	54	-18.77	-17.53
4960	H	94.77	75.56	-31.6	63.17	43.96	74	54	-10.83	-10.04
7440	H	95.82	76.78	-35.5	60.32	41.28	74	54	-13.68	-12.72
9920	H	96.71	77.55	-38.3	58.41	39.25	74	54	-15.59	-14.75
12400	H	95.36	76.62	-39	56.36	37.62	74	54	-17.64	-16.38
14880	H	97.32	78.41	-42	55.32	36.41	74	54	-18.68	-17.59
17360	H	96.79	77.75	-41.5	55.29	36.25	74	54	-18.71	-17.75

Other harmonics emissions are lower than 20dB below the allowable limit.

- Note:**
- (1) All Readings are Peak Value and AV.
 - (2) Emission Level= Reading Level+ Probe Factor +Cable Loss.
 - (3) The average measurement was not performed when the peak measured data under the limit of average detection.
 - (4) Measuring frequencies from 1GHz to 25GHz.

7.6 Radiated Measurement Photos:



7. 6dB Bandwidth Measurement

8.1 Measurement Procedure

The EUT was operating in Bluetooth mode or could be controlled its channel. Printed out the test result from the spectrum by hard copy function.

8.2 Test SET-UP (Block Diagram of Configuration)

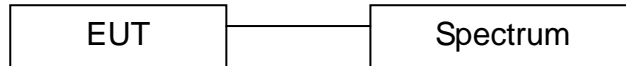

8.3 Measurement Equipment Used:

EQUIPMENT TYPE	MFR	MODEL NUMBER	SERIAL NUMBER	CALIBRATED UNTIL
Spectrum Analyzer	Rohde & Schwarz	FSV40	US40240623	2022-11-12
Coaxial Cable	Gigalink Microwave	ZT40	19022092	2022-11-12
Antenna Connector	ARTHUR-YANG	2244-N1TG1	N/A	2022-11-12

Remark: The temporary antenna connector is soldered on the PCB board in order to perform conducted tests and this temporary antenna connector is listed in the equipment list.

8.4 Limit

The minimum 6dB bandwidth shall be at least 500kHz.

8.5 Measurement Results:

Refer to attached data chart.

Spectrum Detector:	PK	Test Date :	2022-11-12
Test By:	Best	Temperature :	24 °C
Test Result:	PASS	Humidity :	53 %

Condition	Mode	Frequency (MHz)	Antenna	-6 dB Bandwidth (MHz)	Limit -6 dB Bandwidth (MHz)	Verdict
NVNT	BLE 1M	2402	Ant1	0.523	0.5	Pass
NVNT	BLE 1M	2440	Ant1	0.511	0.5	Pass
NVNT	BLE 1M	2480	Ant1	0.512	0.5	Pass

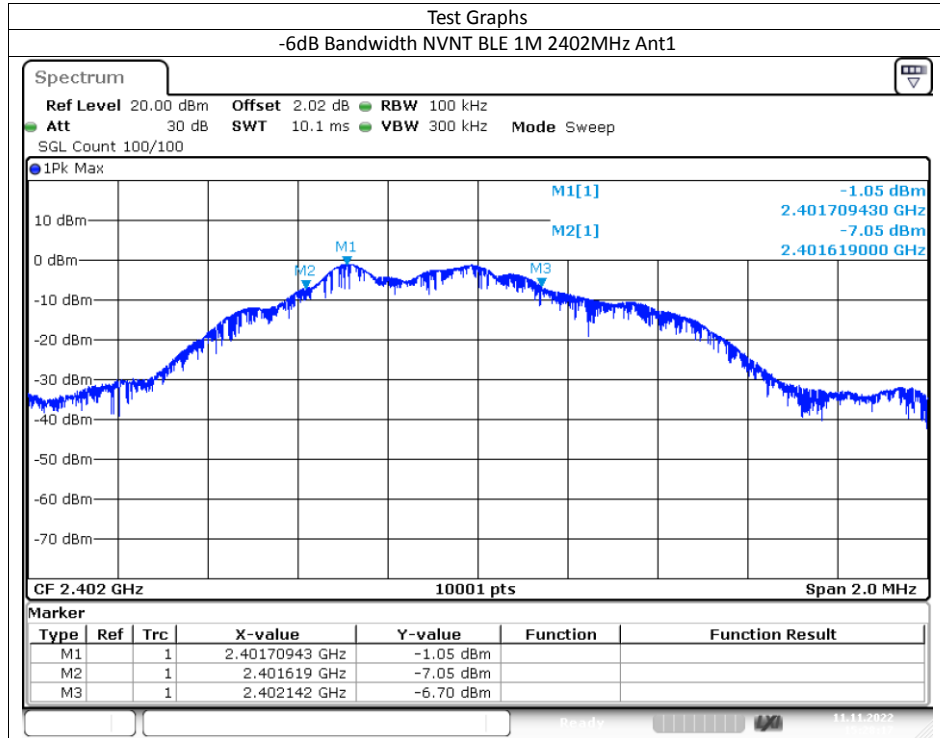

Date: 11.NOV.2022 15:28:16

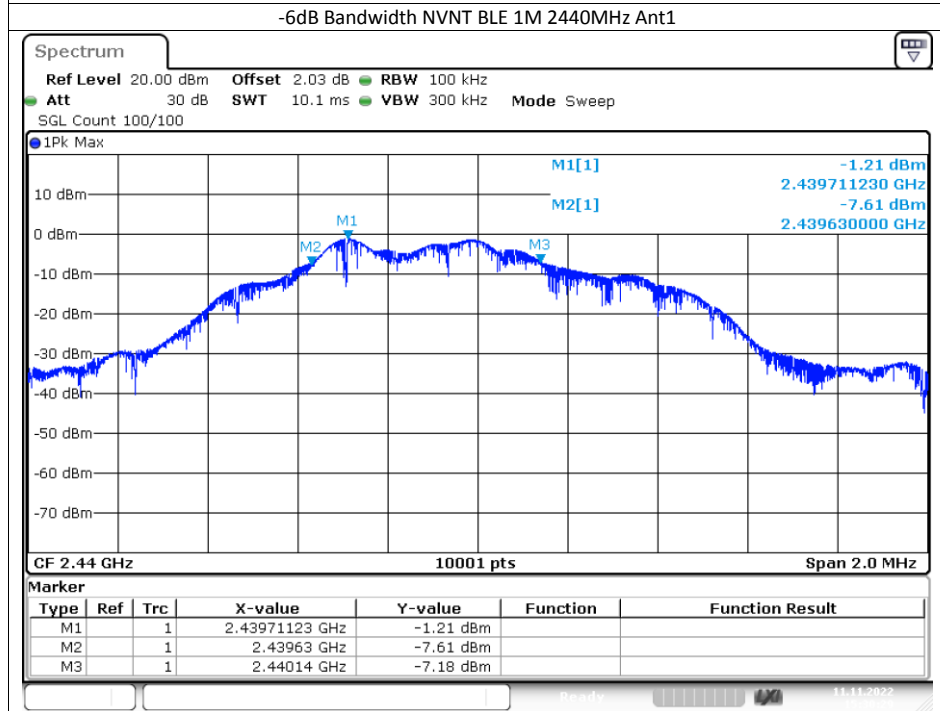

Date: 11.NOV.2022 15:30:29

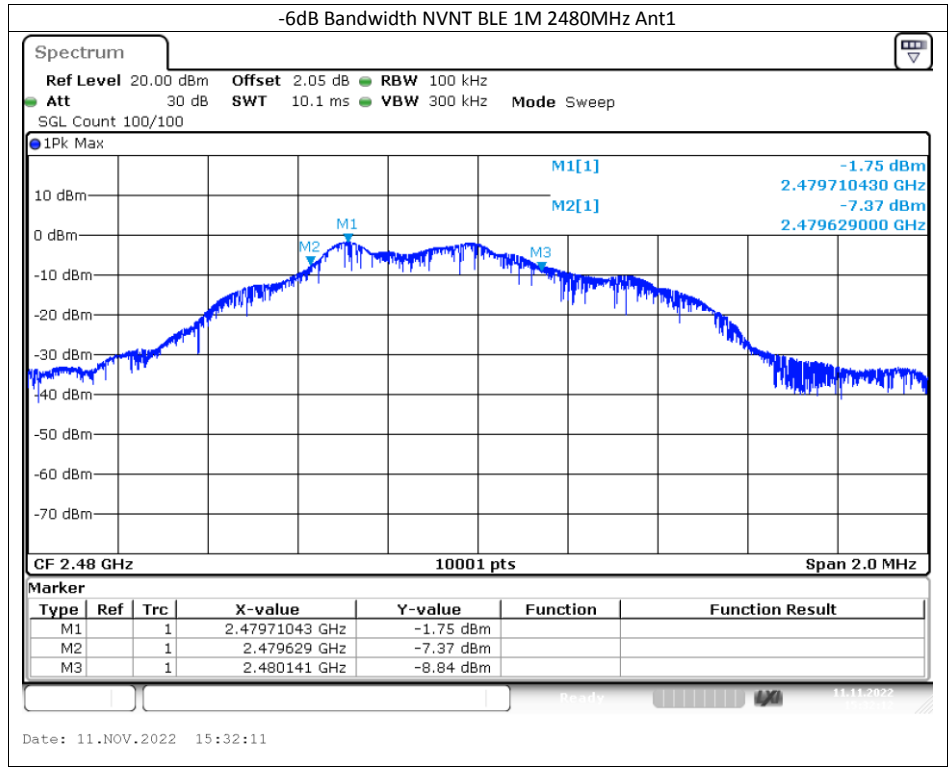

9. MAXIMUM PEAK OUTPUT POWER TEST

9.1 Measurement Procedure

- The Transmitter output (antenna port) was connected to the spectrum Analyzer.
- Turn on the EUT and then record the peak power value.
- Repeat above procedures on all channels needed to be tested.

9.2 Test SET-UP (Block Diagram of Configuration)

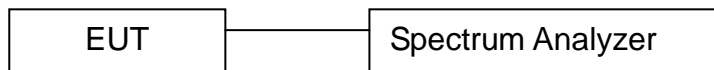

9.3 Measurement Equipment Used:

EQUIPMENT TYPE	MFR	MODEL NUMBER	SERIAL NUMBER	CALIBRATED UNTIL
Spectrum Analyzer	Rohde & Schwarz	FSV40	US40240623	2022-11-12
Coaxial Cable	Gigalink Microwave	ZT40	19022092	2022-11-12
Antenna Connector	ARTHUR-YANG	2244-N1TG1	N/A	2022-11-12

Remark: The temporary antenna connector is soldered on the PCB board in order to perform conducted tests and this temporary antenna connector is listed in the equipment list.

9.4 Peak Power output limit

The maximum peak power shall be less 1Watt.

9.5 Measurement Results:

Refer to attached data chart.

Spectrum Detector:	PK	Test Date :	2022-11-11
Test By:	Best	Temperature :	24 °C
Test Result:	PASS	Humidity :	53 %

Condition	Mode	Frequency (MHz)	Antenna	Conducted Power (dBm)	Duty Factor (dB)	Total Power (dBm)	Limit (dBm)	Verdict
NVNT	BLE 1M	2402	Ant1	-0.93	0	-0.93	30	Pass
NVNT	BLE 1M	2440	Ant1	-1.05	0	-1.05	30	Pass
NVNT	BLE 1M	2480	Ant1	-1.56	0	-1.56	30	Pass

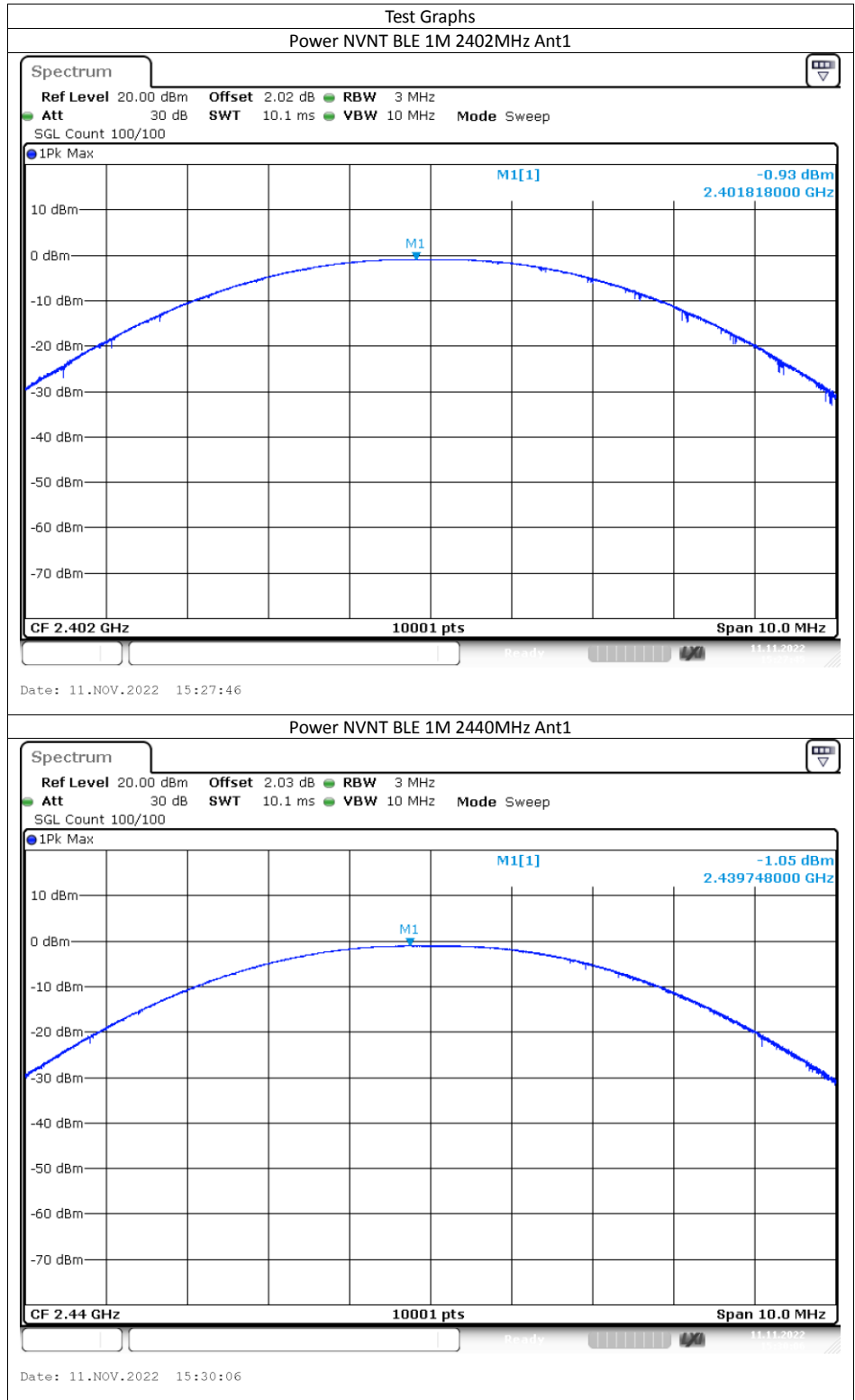

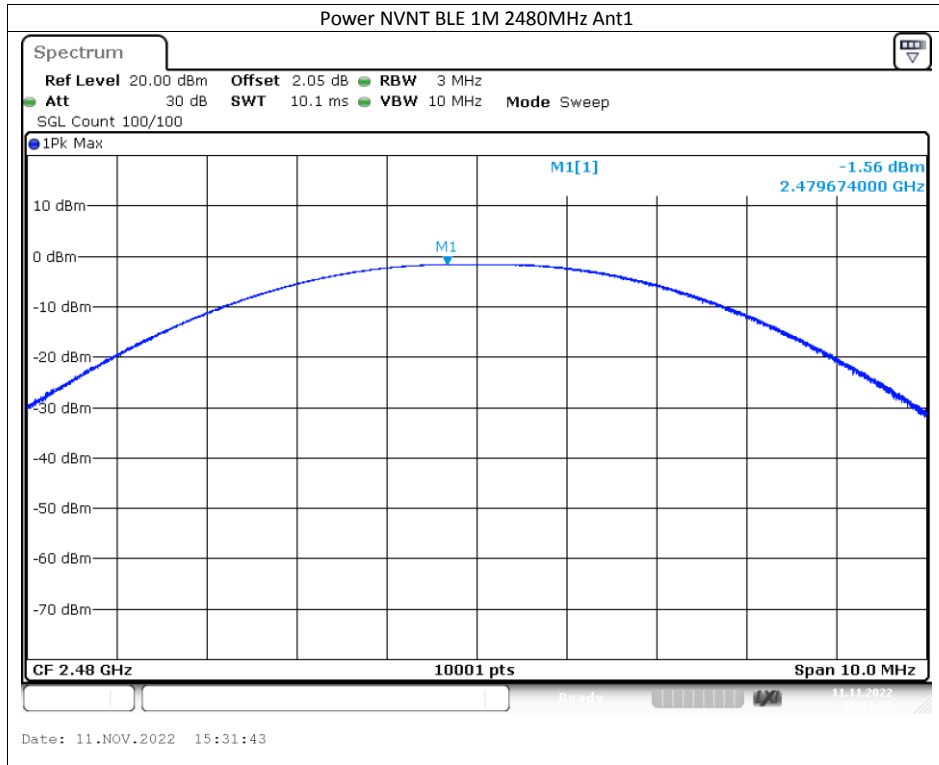

10. Power Spectral Density Measurement

10.1 Measurement Procedure

The EUT was operating in Bluetooth mode or could be controlled its channel. Printed out the test result from the spectrum by hard copy function.

10.2 Test SET-UP (Block Diagram of Configuration)

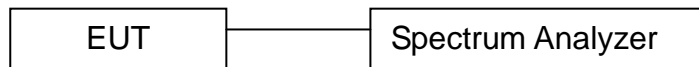

10.3 Measurement Equipment Used:

EQUIPMENT TYPE	MFR	MODEL NUMBER	SERIAL NUMBER	CALIBRATED UNTIL
Spectrum Analyzer	Rohde & Schwarz	FSV40	US40240623	2022-11-12
Coaxial Cable	Gigalink Microwave	ZT40	19022092	2022-11-12
Antenna Connector	ARTHUR-YANG	2244-N1TG1	N/A	2022-11-12

Remark: The temporary antenna connector is soldered on the PCB board in order to perform conducted tests and this temporary antenna connector is listed in the equipment list.

10.4 Measurement Procedure

10.4.1 The RF output of EUT was connected to the spectrum analyzer by RF cable and attenuator. The path loss was compensated to the results for each measurement.

10.4.2. Set to the maximum power setting and enable the EUT transmit continuously.

10.4.3. Make the measurement with the spectrum analyzer's resolution bandwidth (RBW) = 3 kHz. Video bandwidth VBW = 10 kHz In order to make an accurate measurement, set the span to 1.5 times DTS Channel Bandwidth. (6dB BW)

10.4.4. Detector = peak, Sweep time = auto couple, Trace mode = max hold, Allow trace to fully stabilize. Use the peak marker function to determine the maximum power level.

10.4.5. Measure and record the results in the test report.

10.4.6. The Measured power density (dBm)/ 100KHz is a reference level and used as 20dBc down limit line for Conducted Band Edges and Conducted Spurious Emission.

10.5 Measurement Results:

The following table is the setting of spectrum analyzer.

Spectrum analyzer	Setting
Attenuation	Auto
Span Frequency	Set the span to 1.5 times the DTS bandwidth.
RB	3KHz
VB	10KHz
Detector	Peak
Trace	Max hold
Sweep Time	Automatic

Refer to attached data chart.

Spectrum Detector:	PK	Test Date :	2022-11-11
Test By:	Best	Temperature :	24 °C
Test Result:	PASS	Humidity :	53 %

Condition	Mode	Frequency (MHz)	Antenna	Conducted PSD (dBm/3kHz)	Duty Factor (dB)	Total PSD (dBm/3kHz)	Limit (dBm/3kHz)	Verdict
NVNT	BLE 1M	2402	Ant1	-20.51	0	-20.51	8	Pass
NVNT	BLE 1M	2440	Ant1	-20.81	0	-20.81	8	Pass
NVNT	BLE 1M	2480	Ant1	-21.07	0	-21.07	8	Pass

Note:

1. Measured power density(dBm) has offset with cable loss.
2. The measured power density(dBm)/100KHz is reference level and used as 20dBc down for Conducted Band Edges and Conducted Spurious Emission limit line.

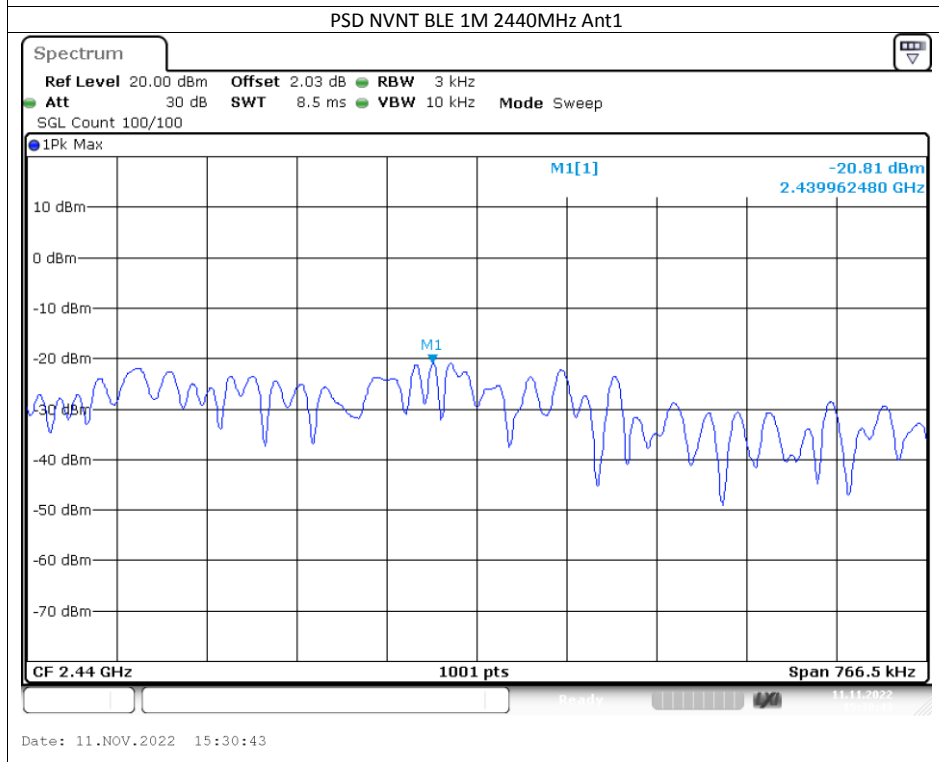
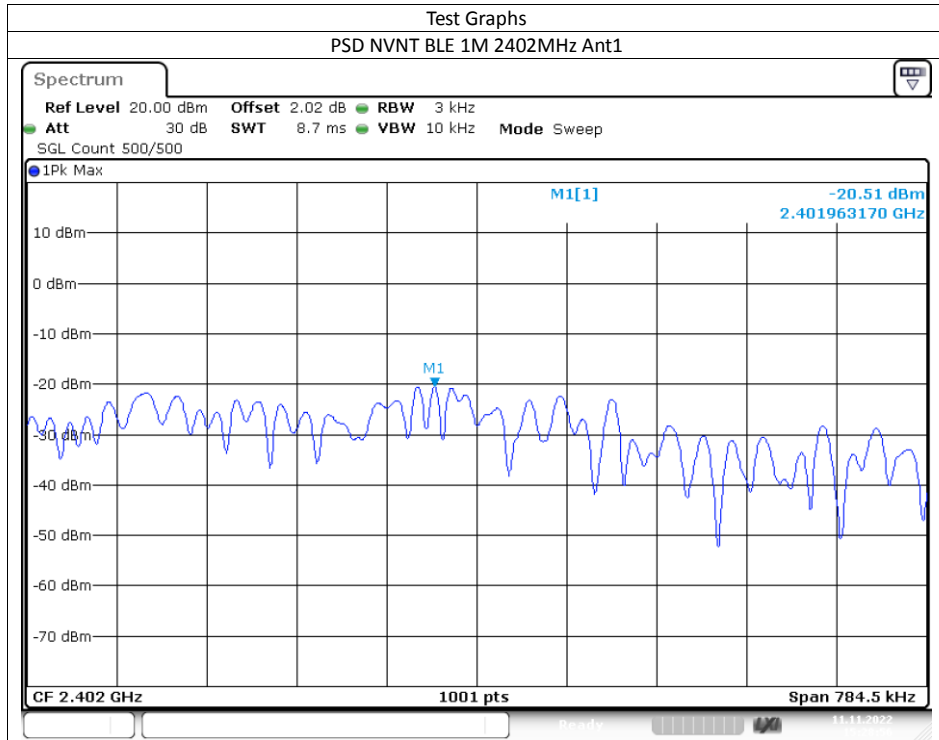

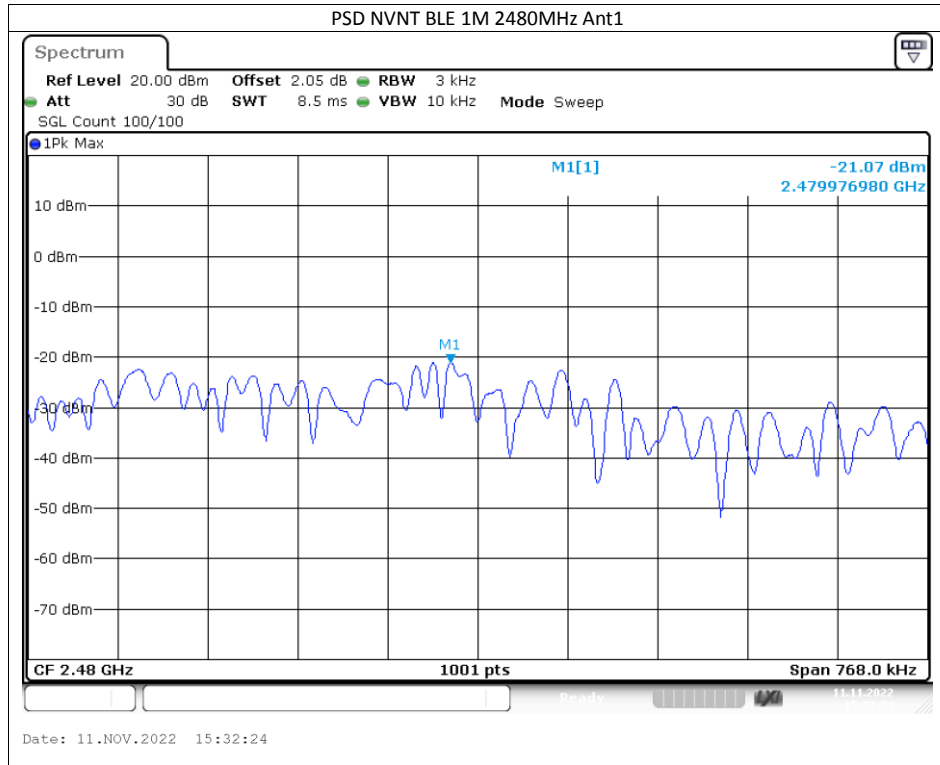

11. Band EDGE test

11.1 Measurement Procedure

For Conducted Test

1. The transmitter output is connected to a spectrum analyzer. The resolution bandwidth is set to 100KHz. The video bandwidth is set to 300KHz.
2. The spectrum from 30MHz to 26 GHz is investigated with the transmitter set to the lowest, middle, and highest channels.

EMI Test Receiver	Setting
Attenuation	Auto
RBW	100KHz
VBW	300KHz
Detector	Peak
Trace	Max hold

For Radiated emission Test

The EUT was placed on a styrofoam table which is 1.5m above ground plane.

The measurement procedure at the band edges was simplified by performing the measurement in just one plot. Both, the in-band-emission and the unwanted emission were encompassed by the span. After trace stabilization, the maximum peak was determined by a peak detector and the value was marked by an appropriate limit line. The second limit line, which is 20dB below the first, marks the limit for the emissions in the unrestricted band. A maximum-peak-detector marks the highest emission in the unrestricted band next to the band edge.

The measurements were performed at the lower end of the 2.4GHz band.

Use the following spectrum analyzer settings:

For Restricted Band, When spectrum scanned above 1GHz setting resolution bandwidth 1MHz, video bandwidth 3MHz:

EMI Test Receiver	Setting
Attenuation	Auto
RBW	1MHz
VBW	3MHz
Detector	Peak
Trace	Max hold

For Non-Restricted Band, When spectrum scanned above 1GHz setting resolution bandwidth 100KHz, video bandwidth 300KHz:

EMI Test Receiver	Setting
Attenuation	Auto
RBW	100KHz
VBW	300KHz
Detector	Peak
Trace	Max hold

11.2 Test SET-UP (Block Diagram of Configuration)

For Conducted Test

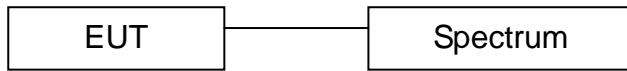

For Radiated emission Test

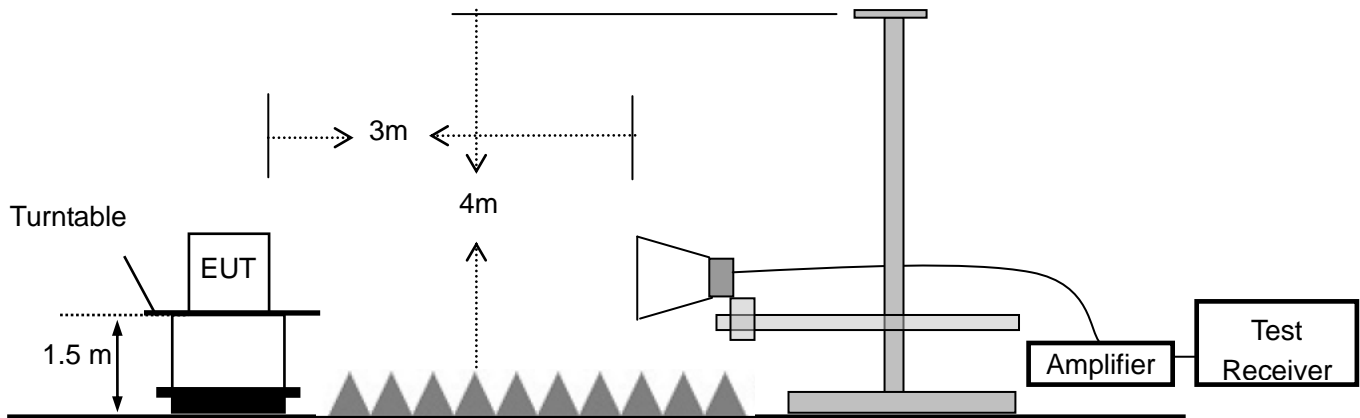

11.3 Measurement Equipment Used:

For Conducted Test

EQUIPMENT TYPE	MFR	MODEL NUMBER	SERIAL NUMBER	CALIBRATED UNTIL
Spectrum Analyzer	Rohde & Schwarz	FSV40	US40240623	2022-11-12
Coaxial Cable	Gigalink Microwave	ZT40	19022092	2022-11-12
Antenna Connector	ARTHUR-YANG	2244-N1TG1	N/A	2022-11-12

Remark: The temporary antenna connector is soldered on the PCB board in order to perform conducted tests and this temporary antenna connector is listed in the equipment list.

For Radiated emission Test

Item	Equipment	Manufacturer	Model No.	Serial No.	Calibrated Until
1	Signal Analyzer	Rohde & Schwarz	FSV40	US40240623	2022-11-12
2	Broadband RF Power Amplifier	AEROFLEX	AEROFLEX100KHz-40G Hz	J1013130524 001	2022-11-12
3	DRG Horn Antenna	A.H.SYSTEMS	SAS-574	J2031090612 123	2022-11-12
4	RF Cable	Gigalink Microwave	ZT40-2.92J-2.92J-2m	N/A	2022-11-12
5	RF Cable	Gigalink Microwave	ZT40-2.92J-2.92J-0.3m	N/A	2022-11-12

11.4 Measurement Results:

Refer to attached data chart.

Spectrum Detector: PK Test Date : 2022-11-11
Test By: Best Temperature : 24 °C
Test Result: PASS Humidity : 53 %

1. Conducted Test

Condition	Mode	Frequency (MHz)	Antenna	Max Value (dBc)	Limit (dBc)	Verdict
NVNT	BLE 1M	2402	Ant1	-50.6	-20	Pass
NVNT	BLE 1M	2480	Ant1	-55.92	-20	Pass

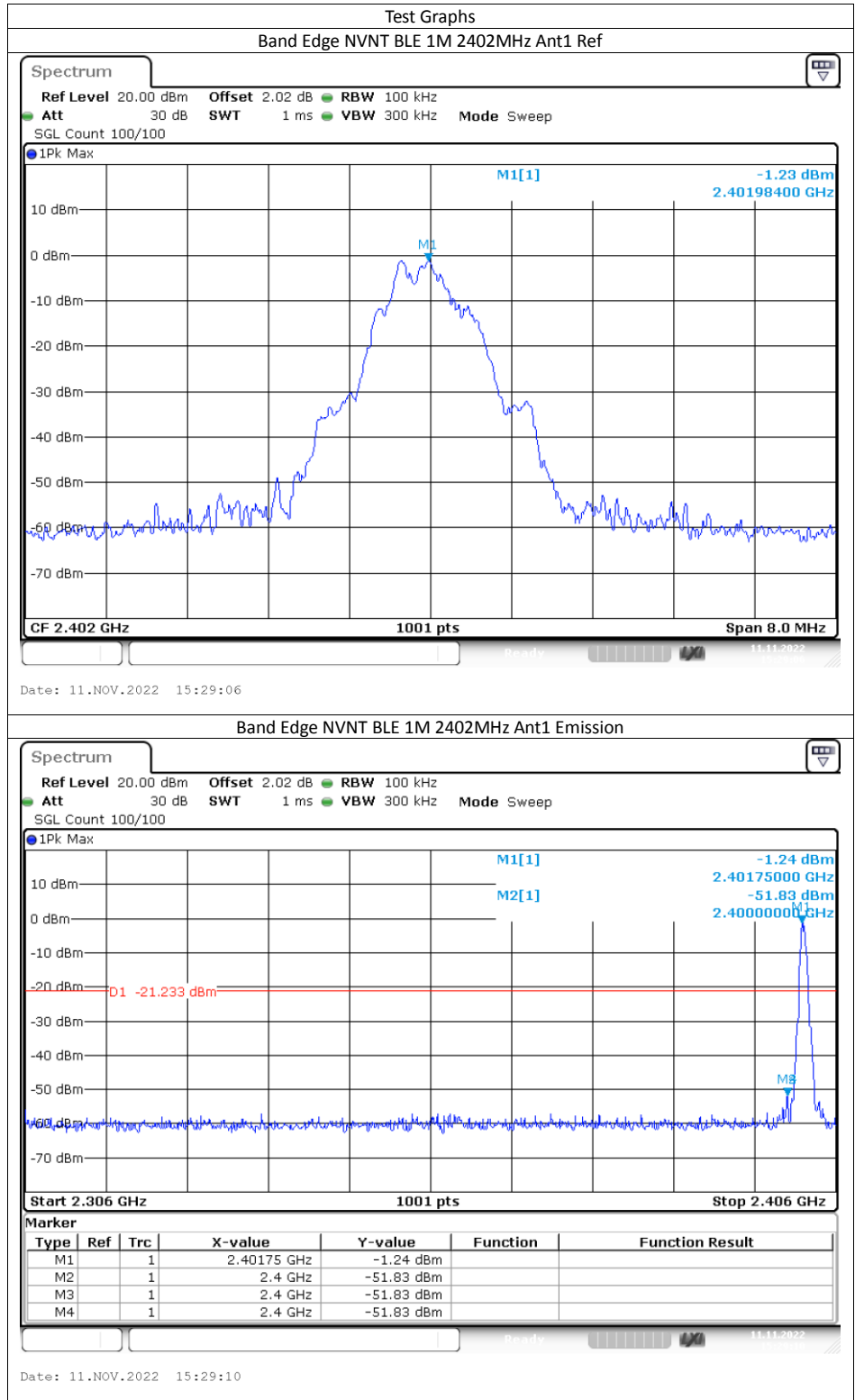

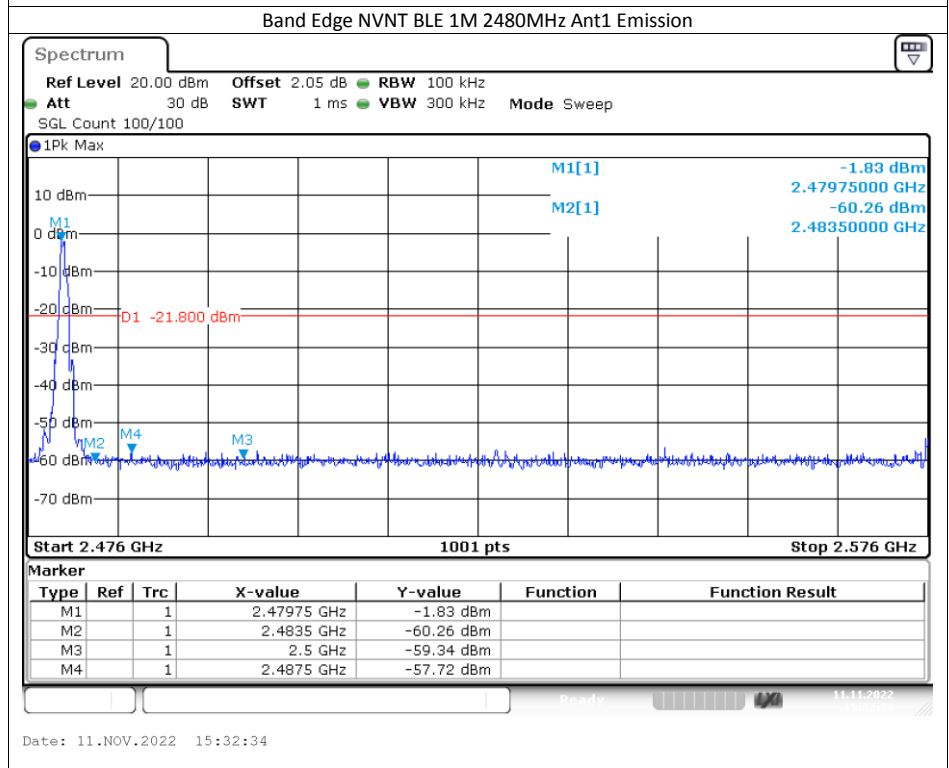
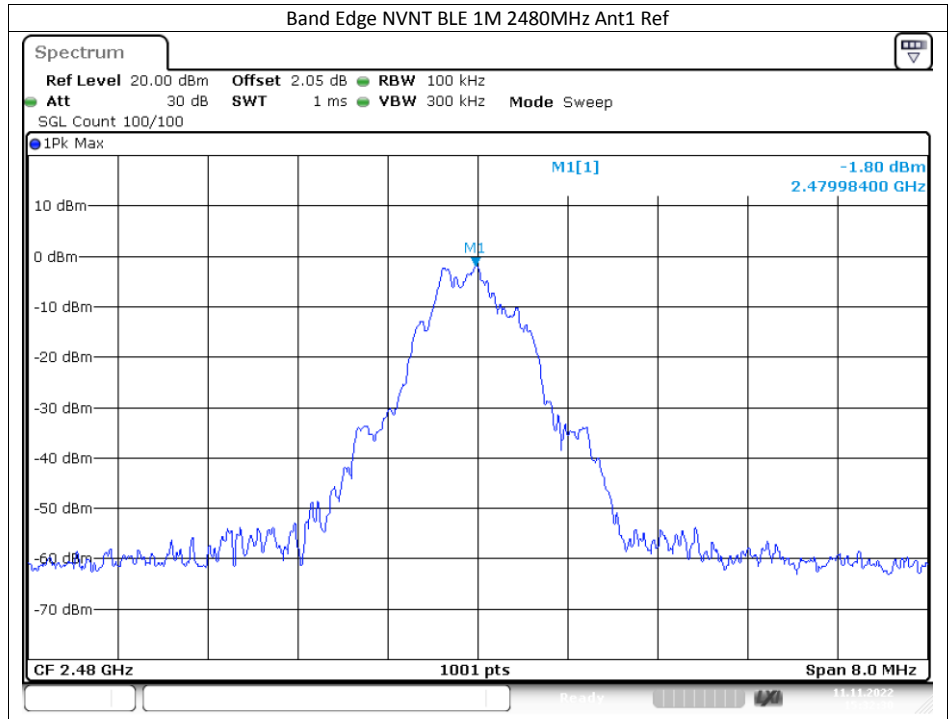

2. Radiated emission Test

Polarization: Vertical

Test Mode:

GFSK-Low

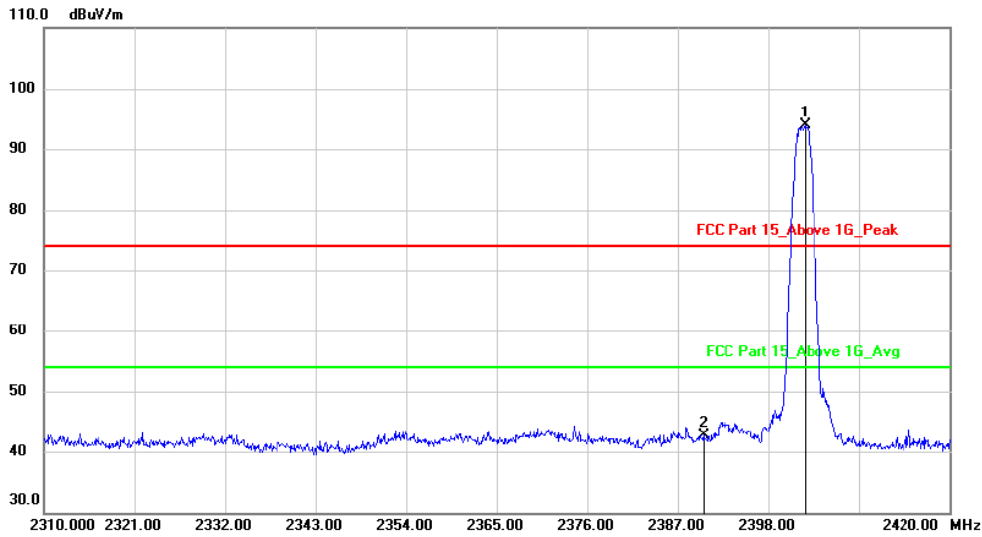

No.	Mk.	Freq.	Reading Level	Correct Factor	Measurement	Limit	Margin	Antenna Height	Table Degree	
		MHz	dBuV	dB	dBuV/m	dBuV/m	dB	cm	degree	Comment
1	*	2402.400	97.23	-3.41	93.82	74.00	19.82			peak
2		2390.000	46.10	-3.40	42.70	74.00	-31.30			peak

Polarization: Horizontal

Test Mode:

GFSK-Low

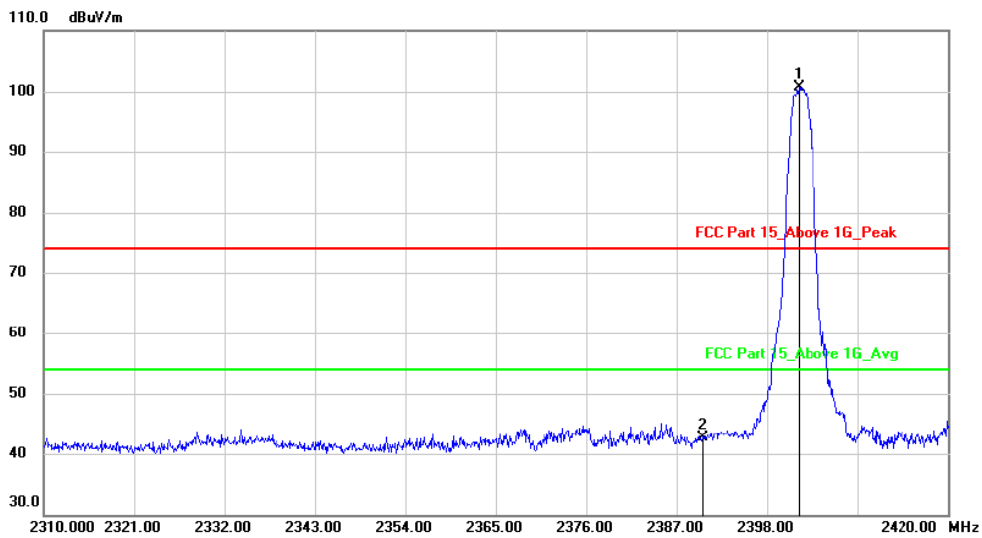

No.	Mk.	Freq.	Reading Level	Correct Factor	Measurement	Limit	Margin	Antenna Height	Table Degree	
		MHz	dBuV	dB	dBuV/m	dBuV/m	dB	cm	degree	Comment
1	*	2401.850	104.19	-3.41	100.78	74.00	26.78			peak
2		2390.000	46.00	-3.40	42.60	74.00	-31.40			peak

Polarization: Vertical

Test Mode: GFSK-High

GFSK-High

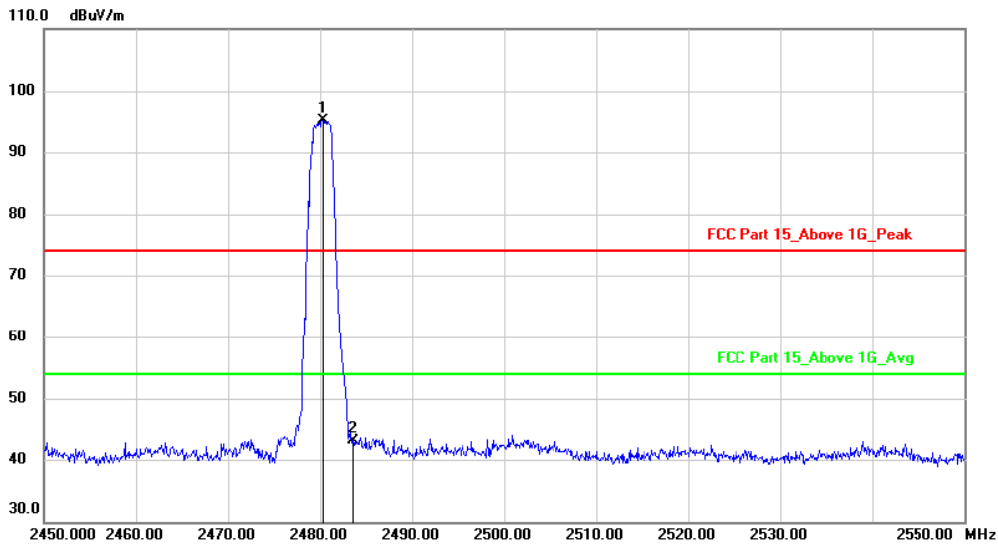

No.	Mk.	Freq.	Reading Level	Correct Factor	Measurement	Limit	Margin	Antenna Height	Table Degree
		MHz	dBuV	dB	dBuV/m	dBuV/m	dB	cm	degree
1	*	2480.300	98.50	-3.38	95.12	74.00	21.12	peak	
2		2483.500	46.39	-3.38	43.01	74.00	-30.99	peak	

Polarization: Horizontal

Test Mode: GFSK-High

GFSK-High

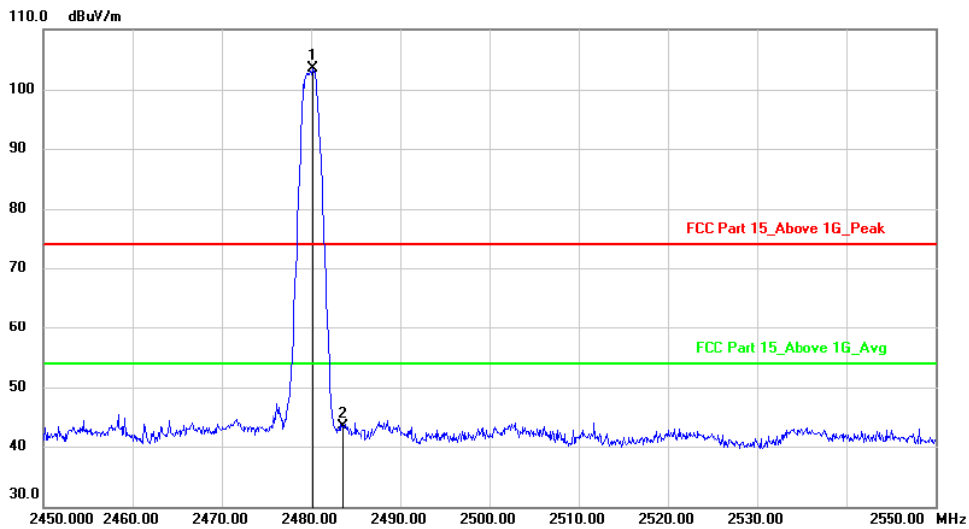

No.	Mk.	Freq.	Reading Level	Correct Factor	Measurement	Limit	Margin	Antenna Height	Table Degree
		MHz	dBuV	dB	dBuV/m	dBuV/m	dB	cm	degree
1	*	2480.200	106.91	-3.38	103.53	74.00	29.53	peak	
2		2483.500	46.84	-3.38	43.46	74.00	-30.54	peak	

12. Antenna requirement

The EUT'S antenna is met the requirement of FCC part 15C section 15.203 and 15.247.

FCC part 15C section 15.247 requirements:

Systems operating in the 2402-2480MHz band that are used exclusively for fixed, point-to-point operations may employ transmitting antennas with directional gain greater than 6dBi provided the maximum peak output power of the intentional radiator is reduced by 1dB for every 3dB that the directional gain of the antenna exceeds 6dBi.

12.2 Result

The EUT's antenna, permanent attached antenna, used a chip antenna and integrated on PCB, The antenna's gain is 2.39dBi and meets the requirement.

13.Photos of EUT





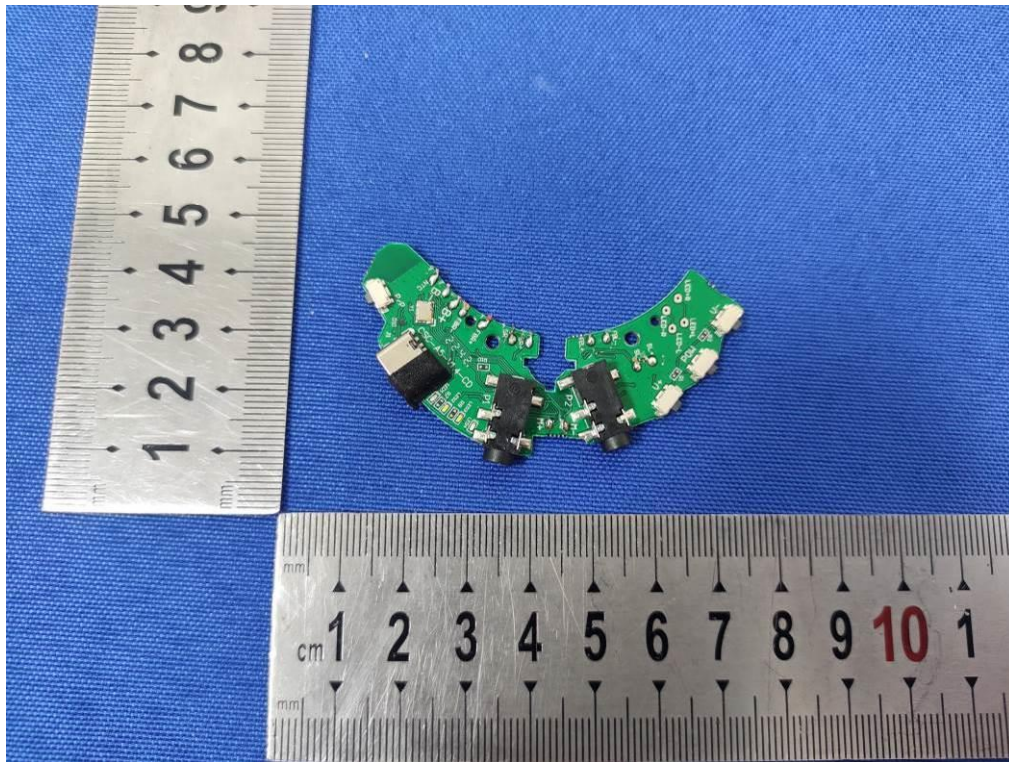
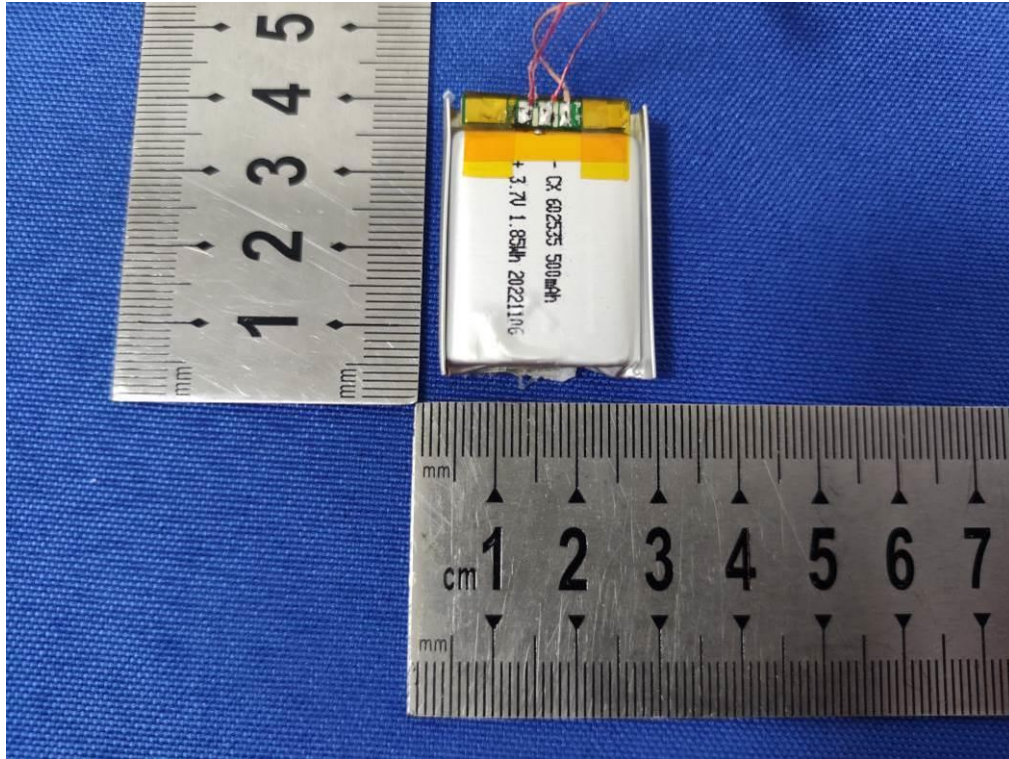

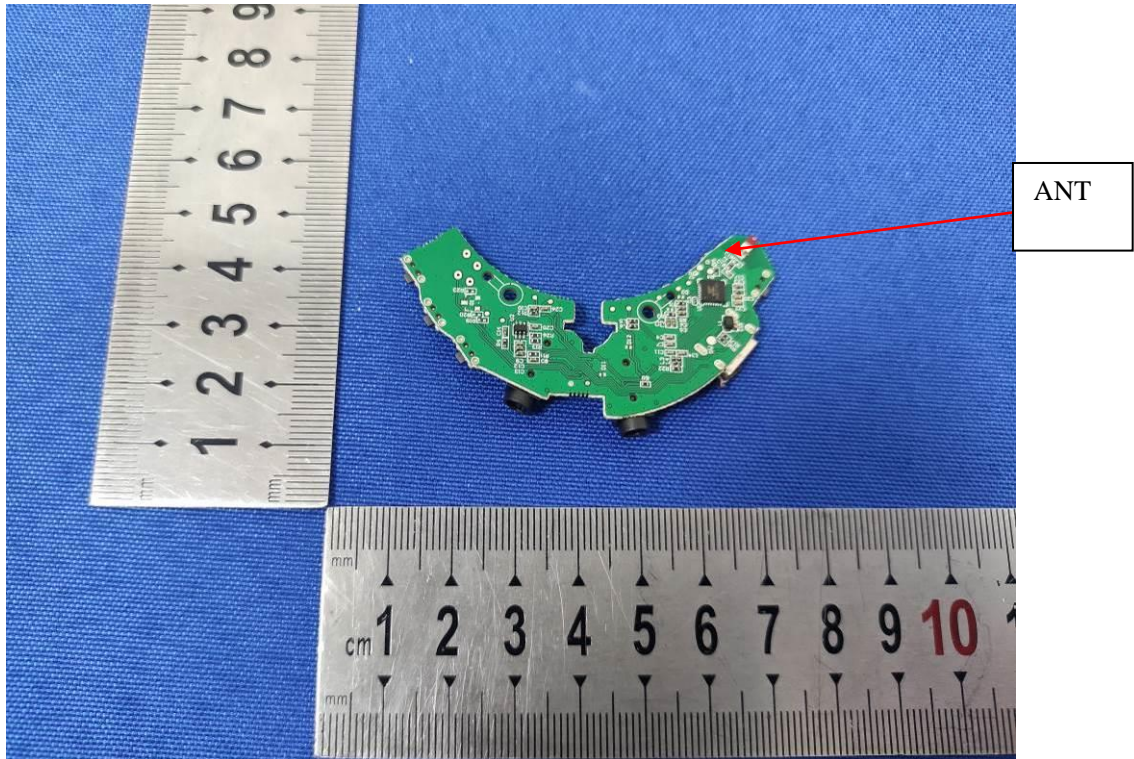

--- End of Report ---