

产品规格承认书

SPECIFICATIONS

客户:

CUSTOMER: _____

产品名称:

DESCRIPTION: Chip antenna

客户型号:

CUSTOMER PART No: _____

产品型号:

OUR MODEL NO: **PBX3216HC01**

日期:

DATE: _____

确认签字, 盖章后请返回承认书一份

PLEASE RETURN TO US ONE COPY OF "SPECIFICATION FOR APPROVAL"

WITH YOUR APPROVED SIGNATURES

| | | |
|--|-----------------|---|
| UNLESS OTHER SPECIFIED TOLERANCES ON: X=± X.X=± X.XX= | |  深圳市朋伴兴业科技有限公司 <small>PENGBANXING</small> |
| ANGLES = ± HOLEDIA = ± | | |
| SCALE: N/A | UNIT: mm | THESE DRAWINGS AND SPECIFICATIONS ARE THE PROPERTY OF PBXY TECHNOLOGY Limited AND SHALL NOT BE REPRODUCED OR USED AS THE BASIS FOR THE MANUFACTURE OR SALE OF APPARATUS OR DEVICES WITHOUT PERMISSION |
| DRAWN BY: Sera | CHECKED BY: XD | |
| DESIGNED BY: Sera | APPROVED BY: XD | |
| TITLE: CHIP2450-3216 Specification | | DOCUMENT NO. 3216 SPEC REV. P1 |

PBX3216HC01 Specification

Operating Temp. : -40°C~+85°C

1. FEATURES:

- Light weight, compact
- Wide bandwidth, low cost
- Built-in antenna with high gain

2. APPLICATIONS:

- Bluetooth, Wireless LAN, Mobile TV
- Home RF System, etc

3. PRODUCT IDENTIFICATION

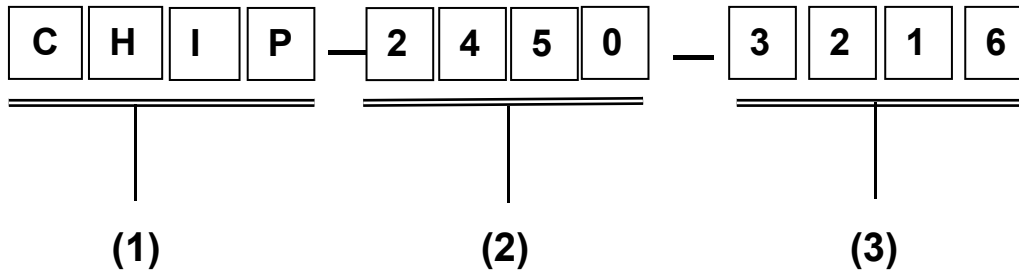

- (1) Product type: Multilayer chip Antenna
 (2) Center Frequency: 2450MHz
 (3) External Dimensions (L×W) (mm): 3.2*1.6

4. SHAPE AND DIMENSIONS:

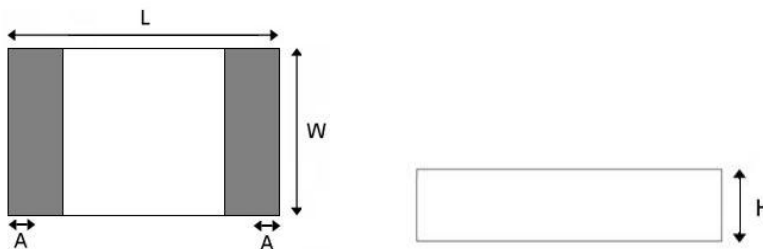

| L | W | H | A |
|---------|---------|----------|---------|
| 3.2±0.2 | 1.6±0.2 | 0.52±0.1 | 0.4±0.1 |

| | | | | |
|---|------------------------|---|-------------|-------------------------------|
| UNLESS OTHER SPECIFIED TOLERANCES ON: X=± X.X=± X.XX= ANGLES = ± HOLEDIA = ± | |  深圳市朋伴兴业科技有限公司 <small>PENGBANXING</small> | | |
| SCALE: N/A | UNIT: mm | THESE DRAWINGS AND SPECIFICATIONS ARE THE PROPERTY OF PBXY TECHNOLOGY Limited AND SHALL NOT BE REPRODUCED OR USED AS THE BASIS FOR THE MANUFACTURE OR SALE OF APPARATUS OR DEVICES WITHOUT PERMISSION | | |
| DRAWN BY: Sera | CHECKED BY: XD | | | |
| DESIGNED BY: Sera | APPROVED BY: XD | | | |
| TITLE: CHIP2450-3216 Specification | | DOCUMENT NO. | 3216 | SPEC REV. P1 |

Unit: mm

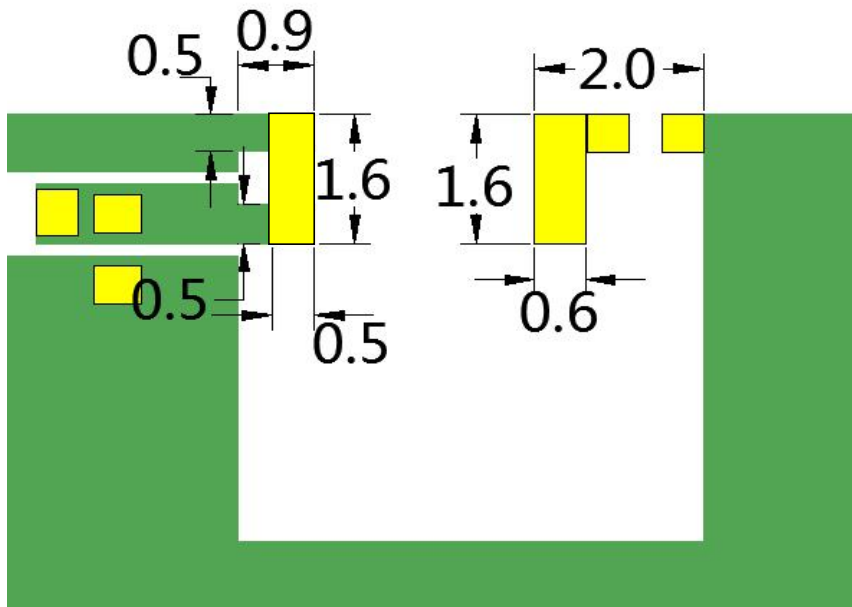
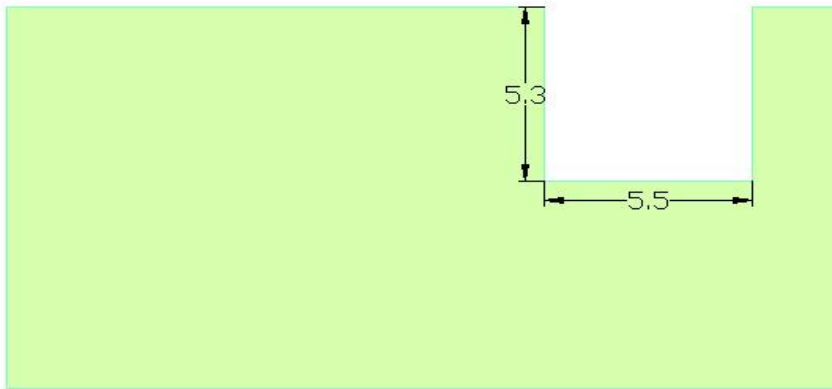
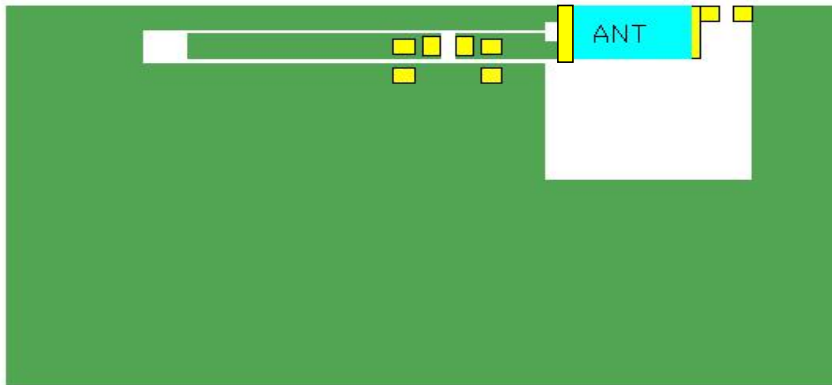

| | | | |
|--|-----------------|---|-----------------|
| UNLESS OTHER SPECIFIED TOLERANCES ON: X=± X.X=± X.XX= | |  深圳市朋伴兴业科技有限公司 | |
| ANGLES = ± HOLEDIA = ± | | | |
| SCALE: N/A | UNIT: mm | THESE DRAWINGS AND SPECIFICATIONS ARE THE PROPERTY OF PBXY TECHNOLOGY Limited AND SHALL NOT BE REPRODUCED OR USED AS THE BASIS FOR THE MANUFACTURE OR SALE OF APPARATUS OR DEVICES WITHOUT PERMISSION | |
| DRAWN BY : Sera | CHECKED BY: XD | | |
| DESIGNED BY: Sera | APPROVED BY: XD | | |
| TITLE: CHIP2450-3216 Specification | DOCUMENT NO. | 3216 | SPEC REV. P1 |

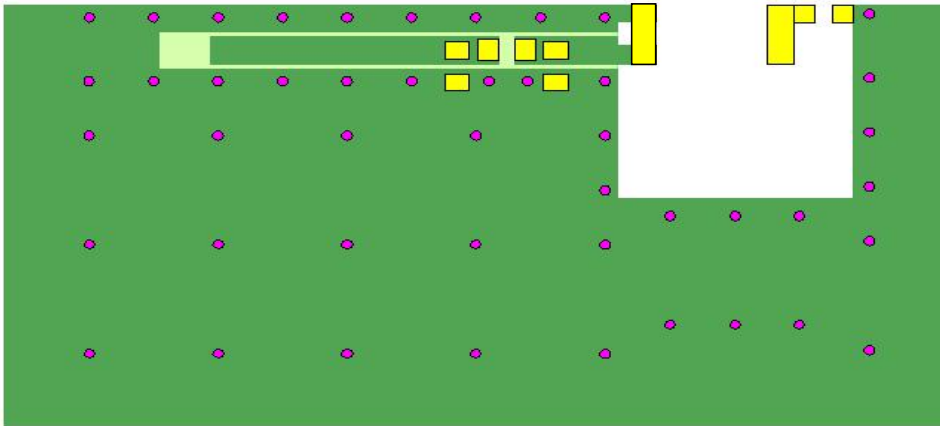

APPLICATION GUIDE

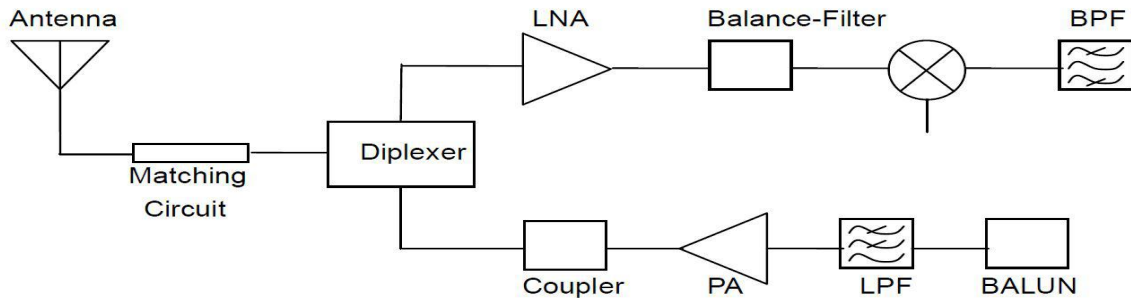

5. SPECIFICATIONS:

| Test item 测试项 | Specification 规格 |
|-------------------|---------------------|
| Bandwidth 带宽 | 2400~2483MHz |
| Polarization mode | Linear polarization |
| Max gain *最大增益 | 2.67dBi |
| Efficiency *效率 | 72.30% |
| Input impedance | 50 Ω |

* Test condition: Test board size 90*40 mm

Matching circuit: Pi matching circuit will be required

| | | |
|--|-----------------|---|
| UNLESS OTHER SPECIFIED TOLERANCES ON: X=± X.X=± X.XX= | |  深圳市朋伴兴业科技有限公司 |
| ANGLES = ± HOLEDIA = ± | | |
| SCALE: N/A | UNIT: mm | THESE DRAWINGS AND SPECIFICATIONS ARE THE PROPERTY OF PBXY TECHNOLOGY Limited AND SHALL NOT BE REPRODUCED OR USED AS THE BASIS FOR THE MANUFACTURE OR SALE OF APPARATUS OR DEVICES WITHOUT PERMISSION |
| DRAWN BY : Sera | CHECKED BY: XD | |
| DESIGNED BY: Sera | APPROVED BY: XD | |
| TITLE: CHIP2450-3216 Specification | | DOCUMENT NO. 3216 |
| | | SPEC REV. P1 |

6. Electrical Characteristics :

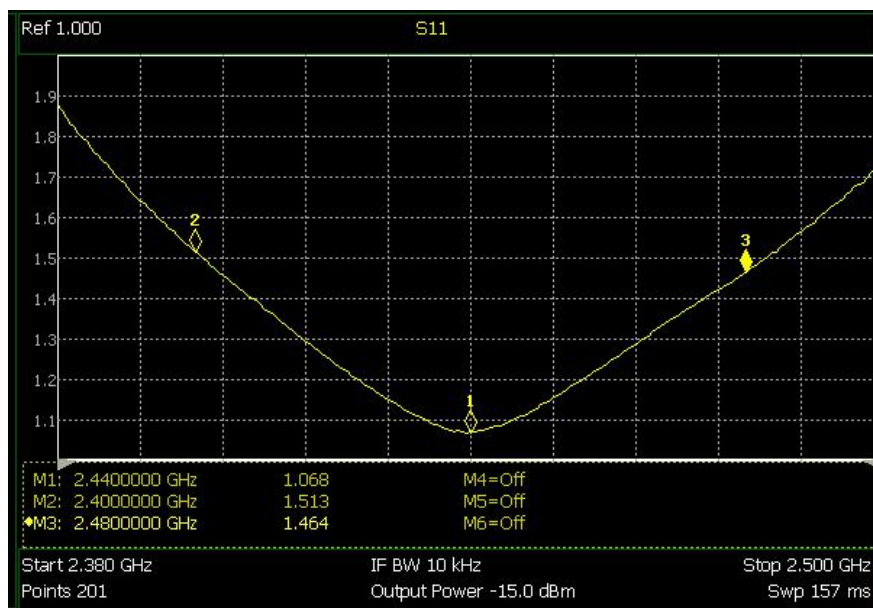
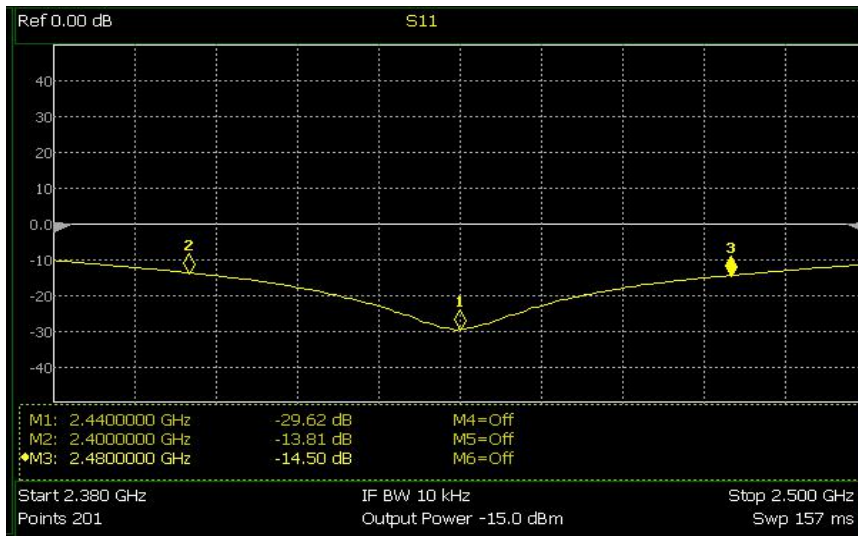

| Mark | Frequency | VSWR |
|------|-----------|-------|
| 1 | 2400 MHz | 1.513 |
| 2 | 2440 MHz | 1.068 |
| 3 | 2480 MHz | 1.464 |

UNLESS OTHER SPECIFIED TOLERANCES ON:

X=± X.X=± X.XX=

ANGLES = ± HOLEDIA = ±

SCALE: N/A

UNIT: mm

DRAWN BY: Sera

CHECKED BY: XD

DESIGNED BY: Sera

APPROVED BY: XD

TITLE: CHIP2450-3216 Specification



深圳市朋伴兴业科技有限公司

THESE DRAWINGS AND SPECIFICATIONS ARE THE PROPERTY OF PBXY TECHNOLOGY Limited AND SHALL NOT BE REPRODUCED OR USED AS THE BASIS FOR THE MANUFACTURE OR SALE OF APPARATUS OR DEVICES WITHOUT PERMISSION

DOCUMENT NO.

3216

SPEC REV.

P1

Radiation Pattern

The Gain pattern is measured in FAR-field chamber. DUT is placed on the table of rotator, a standard horn antenna and Vector Network Analyzer is used to collect data.

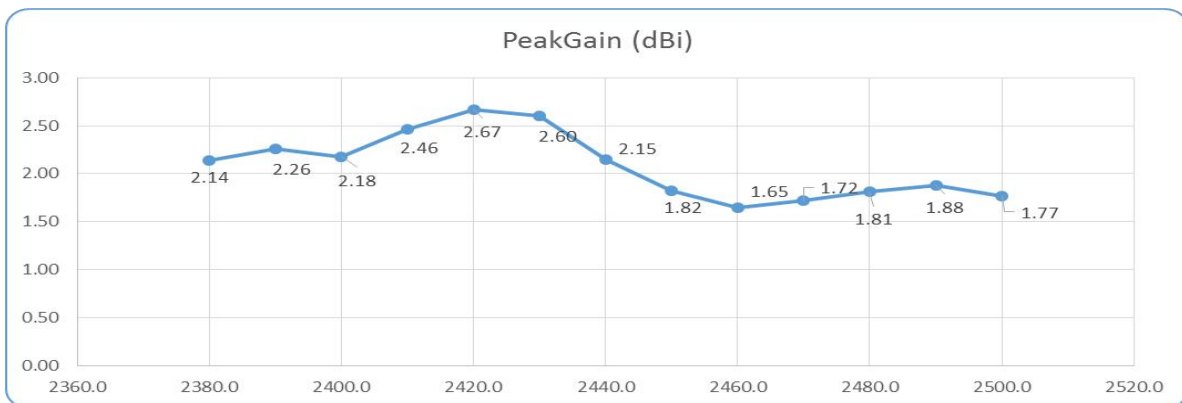
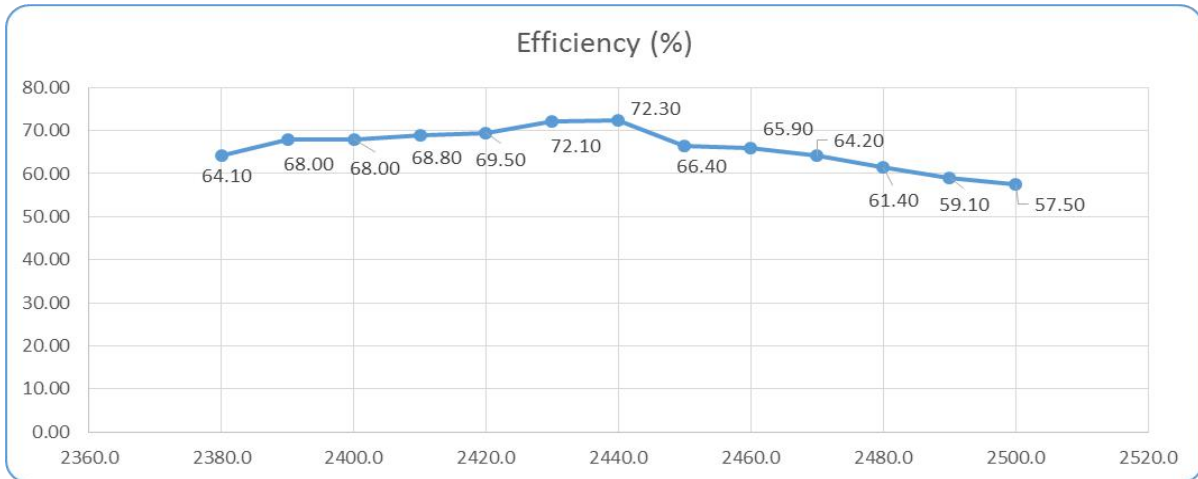
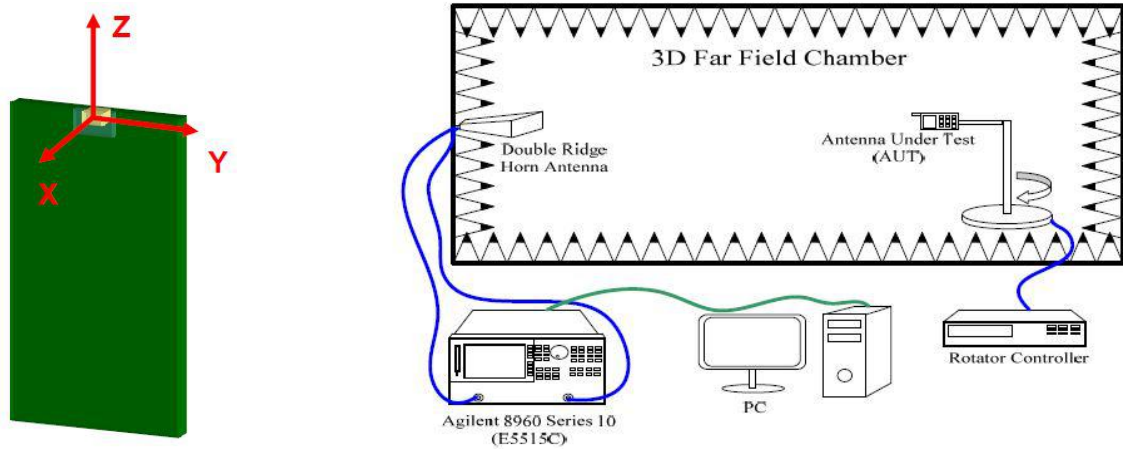

UNLESS OTHER SPECIFIED TOLERANCES ON:

X=± X.X=± X.XX=

ANGLES = ± HOLEDIA = ±

SCALE: N/A UNIT: mm

DRAWN BY: Sera CHECKED BY: XD

DESIGNED BY: Sera APPROVED BY: XD

TITLE: CHIP2450-3216 Specification



深圳市朋伴兴业科技有限公司

THESE DRAWINGS AND SPECIFICATIONS ARE THE PROPERTY OF PBXY TECHNOLOGY Limited AND SHALL NOT BE REPRODUCED OR USED AS THE BASIS FOR THE MANUFACTURE OR SALE OF APPARATUS OR DEVICES WITHOUT PERMISSION

DOCUMENT NO.

3216

SPEC REV.

P1

◎ 3D Gain Pattern (2400 MHz)

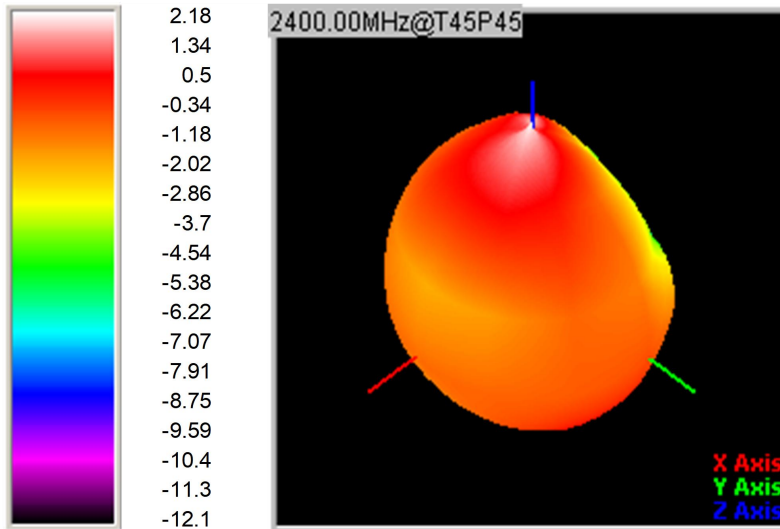

◎ 3D Gain Pattern (2440 MHz)

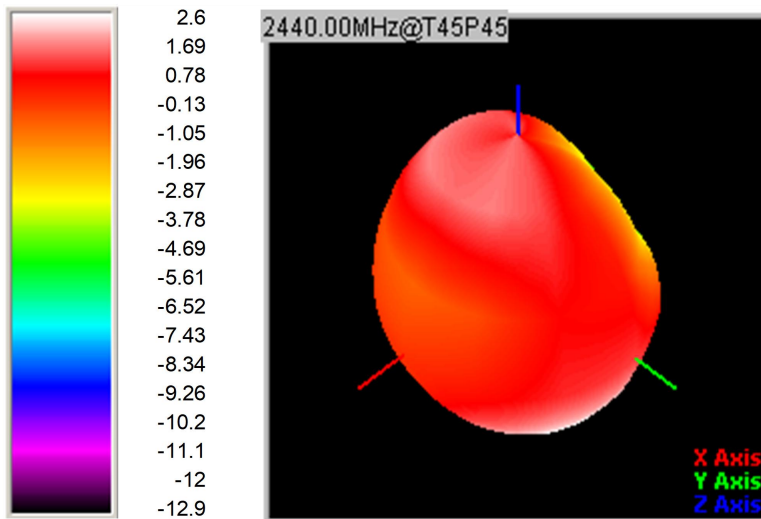

◎ 3D Gain Pattern (2480 MHz)

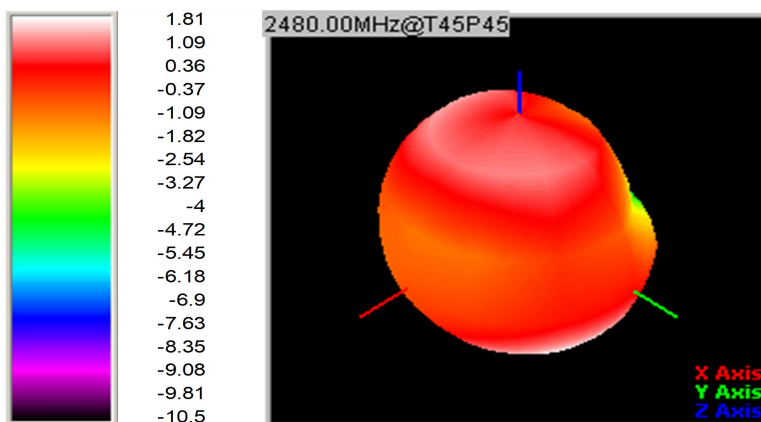

UNLESS OTHER SPECIFIED TOLERANCES ON:

X=± X.X=± X.XX=

ANGLES = ± HOLEDIA = ±



深圳市朋伴兴业科技有限公司

SCALE: N/A

UNIT: mm

DRAWN BY : Sera

CHECKED BY: XD

DESIGNED BY: Sera

APPROVED BY: XD

THESE DRAWINGS AND SPECIFICATIONS ARE THE PROPERTY OF PBXY TECHNOLOGY Limited AND SHALL NOT BE REPRODUCED OR USED AS THE BASIS FOR THE MANUFACTURE OR SALE OF APPARATUS OR DEVICES WITHOUT PERMISSION

TITLE: CHIP2450-3216 Specification

DOCUMENT NO.

3216

SPEC REV.

P1

7. Environmental Characteristics

(1) Reliability Test

| Item | Condition | Specification |
|-----------------------------|--|--|
| Thermal shock | 1. 30±3 minutes at -40° C±5° C, 2. Convert to +105° C (5 minutes) 3. 30±3 minutes at +105° C±5° C, 4. Convert to -40° C (5 minutes) 5. Total 100 continuous cycles | No apparent damage Fulfill the electrical spec. after test. |
| Humidity resistance | 1. Humidity: 85% R.H. 2. Temperature: 85±5° C 3. Time: 1000 hours. | No apparent damage Fulfill the electrical spec. after test. |
| High temperature resistance | 1. Temperature: 150° C±5° C 2. Time: 1000 hours. | No apparent damage Fulfill the electrical spec. after test. |
| Low temperature resistance | 1. Temperature: -40° C±5° C 2. Time: 1000 hours. | No apparent damage Fulfill the electrical spec. after test. |
| Soldering heat resistance | 1. Solder bath temperature : 260±5°C 2. Bathing time: 10±1 seconds | No apparent damage |
| Solderability | The dipped surface of the terminal shall be at least 95% covered with solder after dipped in solder bath of 245±5°C for 3±1 seconds. | No apparent damage |

(2) Storage Condition

(a) At warehouse:

The temperature should be within 0 ~ 30°C and humidity should be less than 60% RH.

The product should be used within 1 year from the time of delivery.

(b) On board:

The temperature should be within -40~85°C and humidity should be less than 85% RH.

(3) Operating Temperature Range

Operating temperature range : -40°C to +105°C.

UNLESS OTHER SPECIFIED TOLERANCES ON:

X=± X.X=± X.XX=

ANGLES = ± HOLEDIA = ±

SCALE: N/A

UNIT: mm

DRAWN BY : Sera

CHECKED BY: XD

DESIGNED BY: Sera

APPROVED BY: XD



深圳市朋伴兴业科技有限公司

THESE DRAWINGS AND SPECIFICATIONS ARE THE PROPERTY OF PBXY TECHNOLOGY Limited AND SHALL NOT BE REPRODUCED OR USED AS THE BASIS FOR THE MANUFACTURE OR SALE OF APPARATUS OR DEVICES WITHOUT PERMISSION

TITLE: CHIP2450-3216 Specification

DOCUMENT NO.

3216

SPEC REV.

P1

8. Recommended Reflow Soldering

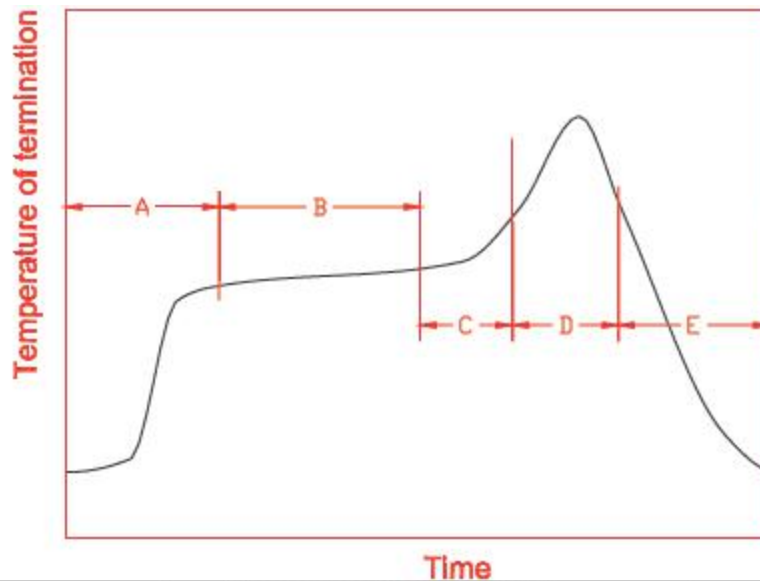

| | | | |
|---|------------------------------------|--------------------------------------|---------------|
| A | 1 st rising temperature | The normal to Preheating temperature | 30s to 60s |
| B | Preheating | 140°C to 160°C | 60s to 120s |
| C | 2 nd rising temperature | Preheating to 200°C | 20s to 40s |
| D | Main heating | if 220°C | 50s~60s |
| | | if 230°C | 40s~50s |
| | | if 240°C | 30s~40s |
| | | if 250°C | 20s~40s |
| | | if 260°C | 20s~40s |
| E | Regular cooling | 200°C to 100°C | 1°C/s ~ 4°C/s |

*reference: J-STD-020C

(1) Soldering Gun Procedure

Note the follows, in case of using solder gun for replacement.

- (a) The tip temperature must be less than 350° C for the period within 3 seconds by using soldering gun under 30 W.
- (b) The soldering gun tip shall not touch this product directly.

(2) Soldering Volume

Note that excess of soldering volume will easily get crack the body of this product.

| | | | |
|--|-----------------|---|-----------------|
| UNLESS OTHER SPECIFIED TOLERANCES ON: X=± X.X=± X.XX= | |  深圳市朋伴兴业科技有限公司 | |
| ANGLES = ± HOLEDIA = ± | | | |
| SCALE: N/A | UNIT: mm | THESE DRAWINGS AND SPECIFICATIONS ARE THE PROPERTY OF PBXY TECHNOLOGY Limited AND SHALL NOT BE REPRODUCED OR USED AS THE BASIS FOR THE MANUFACTURE OR SALE OF APPARATUS OR DEVICES WITHOUT PERMISSION | |
| DRAWN BY : Sera | CHECKED BY: XD | | |
| DESIGNED BY: Sera | APPROVED BY: XD | | |
| TITLE: CHIP2450-3216 Specification | DOCUMENT NO. | 3216 | SPEC REV. P1 |

9. Taping Package and Label Marking: (unit: mm)

(1) Quantity/Reel: 5000pcs/Reel

(2) Carrier tape dimensions

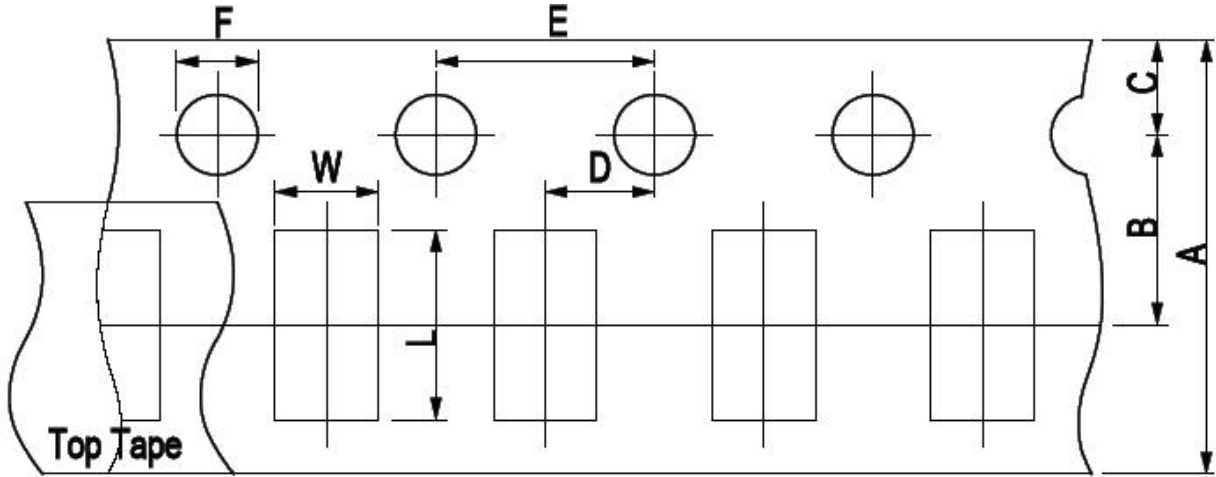

| Type | A | B | C | D | E | F | L | W |
|---------|----------|-----------|----------|-----------|----------|----------|----------|----------|
| 2450-21 | 8.00±0.3 | 3.50±0.05 | 1.75±0.1 | 2.00±0.05 | 4.00±0.1 | 1.50±0.1 | 2.30±0.1 | 1.55±0.1 |

(3) Taping reel dimensions

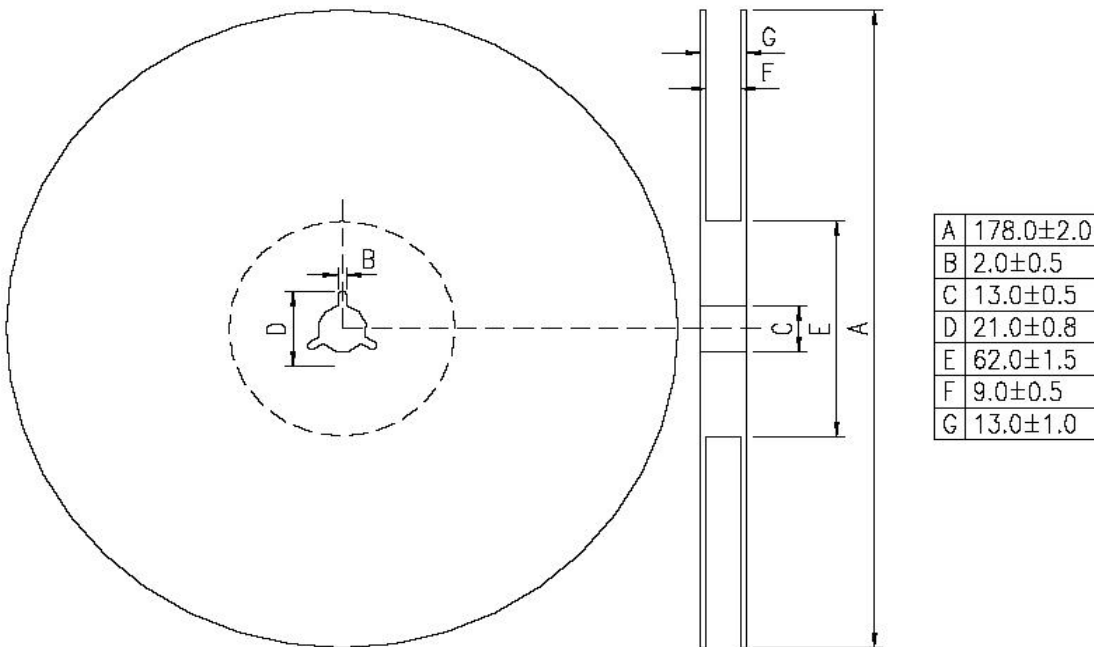

UNLESS OTHER SPECIFIED TOLERANCES ON:

X=± X.X=± X.XX=

ANGLES = ± HOLEDIA = ±

SCALE: N/A

UNIT: mm

DRAWN BY: Sera

CHECKED BY: XD

DESIGNED BY: Sera

APPROVED BY: XD

TITLE: CHIP2450-3216 Specification

DOCUMENT NO.

3216

SPEC REV.

P1



深圳市朋伴兴业科技有限公司

THESE DRAWINGS AND SPECIFICATIONS ARE THE PROPERTY OF PBXY TECHNOLOGY Limited AND SHALL NOT BE REPRODUCED OR USED AS THE BASIS FOR THE MANUFACTURE OR SALE OF APPARATUS OR DEVICES WITHOUT PERMISSION