

- 1.LED lights
- 2.LED on/off
- 3.LCD
- 4.AC output 120V
- 5.AC power button
- 6.DC output power button
- 7.Anderson output port 378W
- 8.Main power button
- 9.Cigarette Lighter Port 120W
- 10.WIFI/Bluetooth pairing button
- 11.. USB-C 100W output port*2
- 12.USB-A*1 12W, scalable
- 13.USB-A 18W fast charging output port*3
- 14.USB output power button
- 15.DC5521 output port*2
- 16.Solar/Car charging input port
- 17.AC charging input port 1800W
- 18.AC input overload protector
- 19.AC charge speed switch
- 20.Power Pack Connection Interface*2 3.6kwh

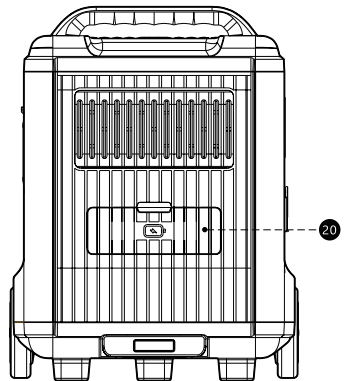

LCD

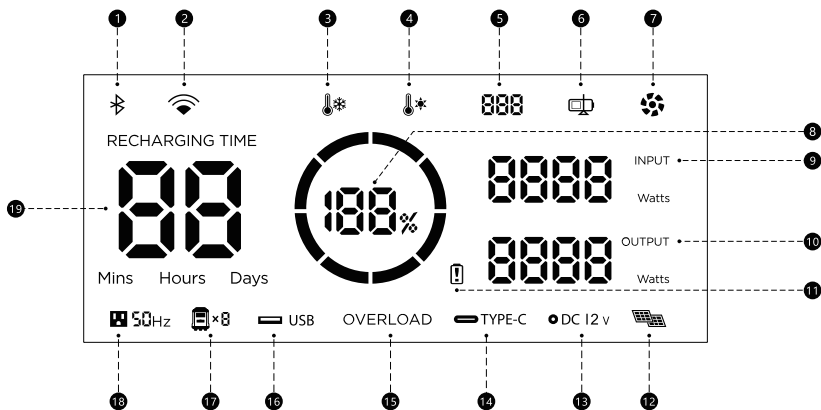

1 Bluetooth

2 WIFI

3 Low temperature warning

4 High temperature warning

5 Error code

11 Battery pack failure warning

12 Solar charging

13 DC output

14 USB output

15 OVERLOAD Output overload warning

6 Charging state

7 Fan

8 Battery percentage

9 INPUT Input power

10 OUTPUT Output power

16 USB-A output

17 Power Pack Access

18 AC output

19 Remaining charge/discharge time

01 Power On/Off

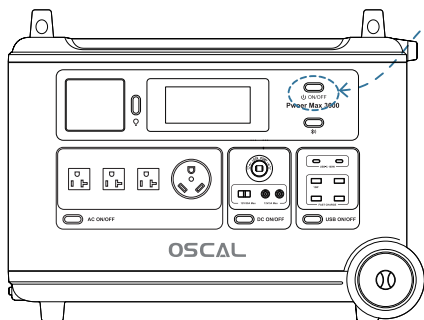

ON

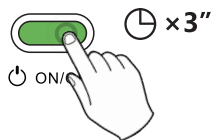

OFF

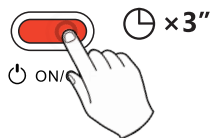

02 Power Pack Connection Charging

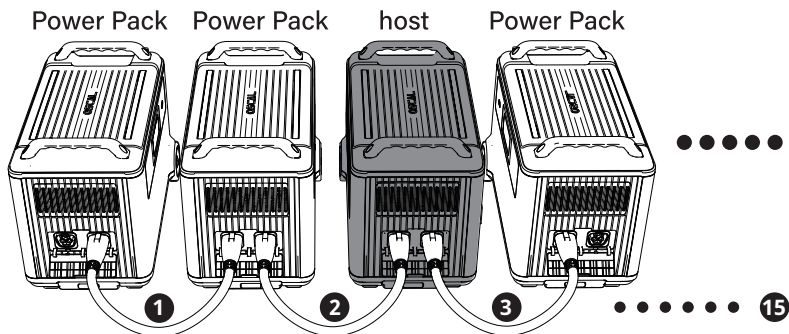

① ② ③ ... ⑮ Three different connection methods can increase battery capacity

03

Charging Your Devices

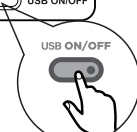
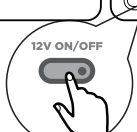
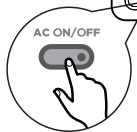
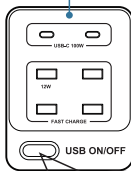
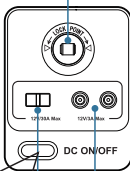
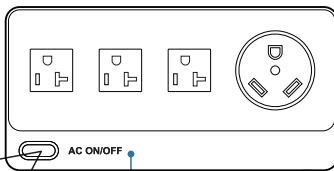
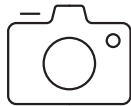
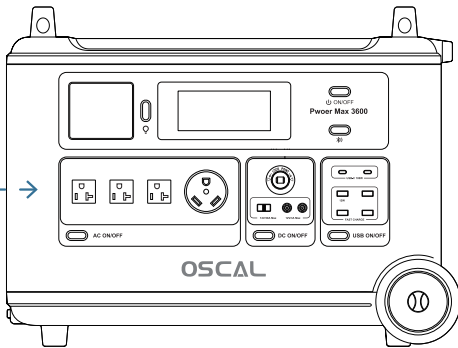

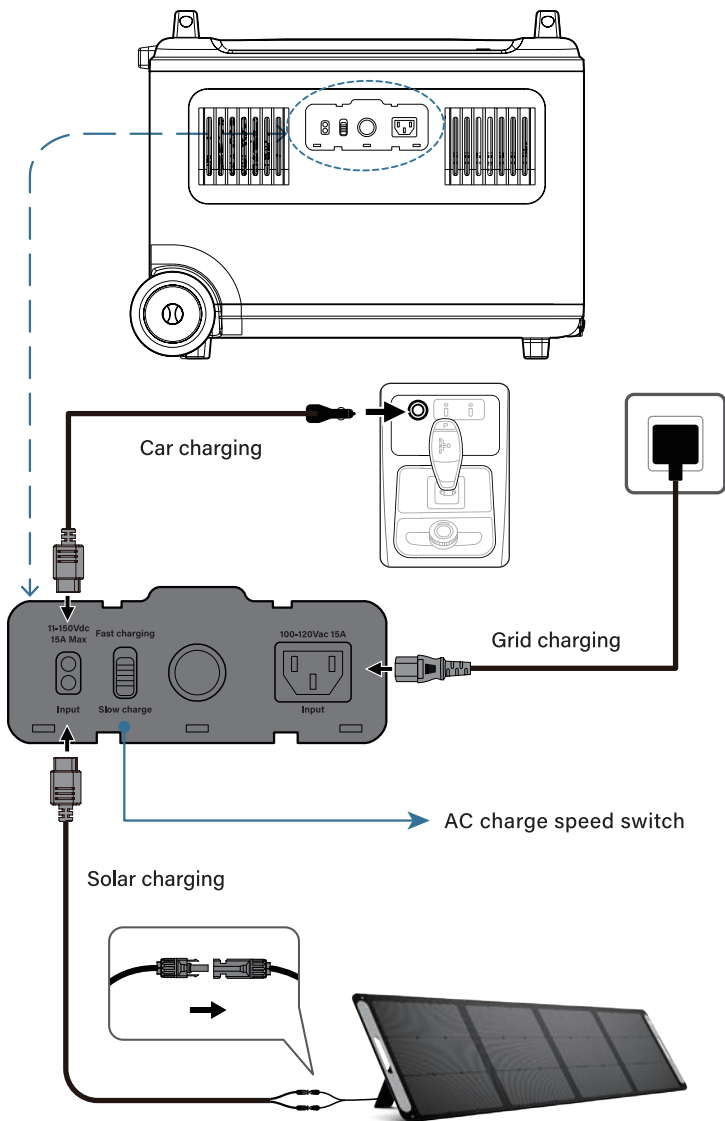

Specifications

General Info

Net Weight	Approximately 44.45kg
Dimension (L × W × H)	590×350×441mm(23.2×13.8×17.5in)
Capacity	3600Wh
Wi-Fi	Frequency Range:2412-2462MHz Maximum Output Power:0.05862W
Bluetooth	Frequency Range:2402-2480MHz Maximum Output Power:0.0006W

Output Ports

AC (×4)	Pure sinewave,3000W total,3*20A+1*30A,100-120V ~ (50Hz/60Hz)
USB-A (×1)	12W Max
USB-A Fast Charging (×3)	18W Max per port,total 54W
USB-C (×2)	100W Max per port,total 200W
Car Charger	12V=10A,120W Max
DC5521 Output (×2)	12V=3A,36W
Anderson Output	12.6V=30A,378W Max

Input Ports

AC Charge	Fast charging 1800W,Slow charging 1200W
AC Input Voltage	100-120V~15A
Solar Charger	11-150V=15A Max,1,600W Max
Car Charger	12V/24V=8A Max,192W Max

Battery Info

Cell Chemistry	LFP
Cycle Life	3,500 cycles to 80% + capacity
Protection Type	Over Voltage Protection, Overload Protection, Over Temperature Protection, Short Circuit Protection, Low Temperature Protection, Low Voltage Protection, Overcurrent Protection

Operating Temperature

Optimal Operating Temperature	20°C~30°C (68°F~86°F)
Discharging Temperature	-10°C~45°C (14°F~113°F)
Charging Temperature	0°C~45°C (32°F~113°F)
Storage Temperature	-10°C~45°C (14°F~113°)

Add-ons (sold separately)

Lithium battery charging package	Up to fifteen units, the total capacity is 16 * 3.6kwh=57.6kwh, and the power pack is sold separately
solar panel	Support solar charging, 11-150V15A Max, 1600W Max, sold separately



Safety Instructions

Usage

1. Do not use the product near a heat source, such as a fire source or a heating furnace.
2. Avoid contact with any liquid. Do not immerse the product in water or get it wet. Do not use the product in rain or humid environments.
3. Do not use the product in an environment with strong static electricity/magnetic fields.
4. Do not disassemble the product in any way or pierce the product with sharp objects.
5. Avoid using wires or other metal objects that may result in a short circuit.
6. Do not use unofficial components or accessories. If you need to replace any components or accessories, please visit official channels to check relevant information.
7. When using the product, please strictly follow the operating environment temperature specified in this user manual. If the temperature is too high, it may result in a fire or explosion; if the temperature is too low, the product performance may be severely reduced, or the product may cease to work.
8. Do not stack any heavy objects on the product.
9. Do not lock the fan forcibly during use.
10. Please avoid impact, falls, or severe vibrations when using the product. In case of a severe external impact, turn off the power supply immediately and stop using the product. Ensure the product is well fastened during transportation to avoid vibrations and impacts.
11. If you accidentally drop the product into water during use, please place it in a safe open area, and stay away from it until it is completely dry. The dried product should not be used again, and should be properly disposed of according to section "Disposal Guide" below. If the product catches fire, we recommend that you use the fire extinguishers in the following order: water or water mist, sand, fire blanket, dry powder, and finally a carbon dioxide fire extinguisher.
12. Use a dry cloth to clean off dirt on the product ports.
13. Rest the product on a flat surface to avoid damages caused by the product falling over. If the product is overturned and severely damaged, turn it off immediately, place the battery in an open area, keep it away from combustible matter and people, and dispose of it in accordance with local laws and regulations.
14. Ensure that the product is kept out of reach of children and pets.
15. Store the product in a dry and ventilated place.
16. It is recommended to use moisture barrier bags in wet environments (for example, places by the sea or waterways) to prevent the product from getting soaked. If water is found inside the product, it must not be used or turned on again. Please take anti-electric shock measures before touching the product. Following this, place the product in a safe, waterproof and open area. Once complete contact CustomerService immediately.
17. This product is not recommended for powering medical emergency equipment related to personal safety, including but not limited to medical grade ventilators (hospital version CPAP: Continuous Positive Airway Pressure), artificial lungs (ECMO, Extracorporeal Membrane Please follow your doctor's instructions and consult with the manufacturer for restrictions on the use of the equipment. If used for general medical equipment, please be sure to monitor the power status to ensure that the power does not run out.
18. When in use, power supply products will generate electromagnetic fields, which are likely to affect the normal operation of medical implants or personal medical equipment such as pacemakers, cochlear implants, hearing aids, defibrillators etc. If these types of medical equipment are being used, please contact the manufacturer to inquire about any restrictions on the use of such equipment. These measure are fundamental to ensure a safe distance between the medical implants (for example, pacemakers, cochlear implants, hearing aids, defibrillators etc.) and this product while in use.
19. When the power supply is connected in normal mode to a refrigerator, power fluctuations may cause the power supply to automatically shut down. When connecting the power supply to a refrigerator that stores medicine, vaccines or other valuable items, it is recommended to set the AC output to "Always on" in the app. This helps support a continuous power supply and ensures a safe and efficient power consumption state.

Disposal Guide

1. If conditions permit, make sure that the battery is fully discharged before disposing it in a designated battery recycling bin. The product contains batteries with potentially dangerous chemicals, so it is strictly prohibited to dispose it in ordinary trash cans. For more details, please follow the local laws and regulations on battery recycling and disposal.
2. If the battery cannot be fully discharged due to a product failure, please do not dispose of the battery directly in the battery recycling box. In such case, you should contact a professional battery recycling company for further processing.
3. Please dispose of over-discharged batteries that cannot be recharged.

Error code and handling

DTC	Exception	Abnormal recovery method
001	Over Voltage Protection	Stop charging and let stand for a period of time, or automatically restore after discharge
002	Low Voltage Protection	Recovery after charging with mains power
003	Discharge current overload	Remove abnormal load and automatically recover after normal load
004	Charging current overload	Automatic recovery after disconnecting charging
005	Short circuit protection	Please contact after-sales
006	Battery collection disconnection	Please contact after-sales
007	Low temperature of battery charging	The battery temperature recovers automatically after it returns above 0°C
008	Battery charging high temperature	The battery recovers automatically after cooling down
009	Battery discharge low temperature	The battery automatically recovers when the temperature is higher than -20 °C
010	Battery discharge high temperature	The battery recovers automatically after cooling down
013	The total battery voltage is too high	Automatic recovery after stopping charging
014	The total battery voltage is too low	Automatic recovery after charging
015	MPPT failure	Please contact after-sales
016	Prohibit photovoltaic charging	The system automatically recovers after a period of delay
018	Battery failure	Automatic recovery after discharge

UPS

The product supports UPS. When you connect the grid power to the AC Input Port of the product through an AC cable, you can power electrical devices through the AC Output Port (AC power will come from the grid and not the power station in this situation). In case of a sudden blackout, the product can automatically switch to the battery powered supply mode within 10ms.



As a basic UPS function, this function does not support Oms switching. Please do not connect the product to any device that requires Oms UPS, such as data servers and workstations. Please test and confirm the compatibility before using the product. We recommend that you only charge one device at a time and avoid using multiple ones at the same time to avoid overload protection. OSCAL takes no responsibilities for any device failures or data losses caused by failures to follow instructions.

APP Connection

① Download Smart Life APP

Download Method 1

Go to the App Store and
Android app store search
Download and install "Smart
Life"

Download method 2



- ② Select the appropriate version according to the country and register and log in to the Smart Life app.
- ③ Turn on the Bluetooth button and press it for more than 5 seconds to initialize Bluetooth

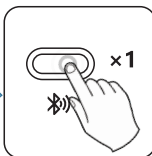
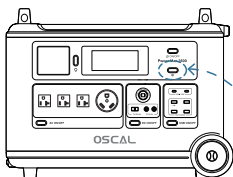

Click the button to
open Bluetooth



Long press the button
to reset Bluetooth

④ Click APP to add a device.

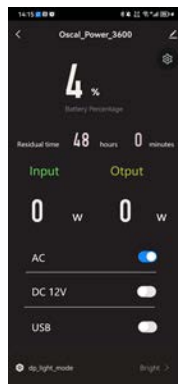
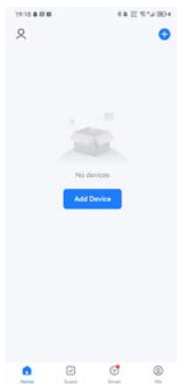

Disclaimer

Before use, please read the user manual of this product to ensure that it is used correctly after full understanding. After reading, please keep the user manual safe for future reference. If this product is not handled correctly, you may cause serious injury to yourself or others, or cause product damage and property damage. Once you use this product, you are deemed to have understood, recognized and accepted all the terms and contents of this document. The user undertakes to be responsible for his actions and all consequences arising therefrom. The company shall not be liable for all losses caused by the user's failure to use the product in accordance with the "User Manual".

In accordance with laws and regulations, the company reserves the right to make the final interpretation of this document and all documents related to this product. This document is subject to change (update, amendment or termination) without notice. Please visit the OSCAL official website for the latest product information.

FCC Caution:

This device complies with part 15 of the FCC Rules. Operation is subject to the following two conditions:(1) this device may not cause harmful interference, and (2) this device must accept any interference received, including interference that may cause undesired operation.

Any changes or modifications not expressly approved by the party responsible for compliance could void the user's authority to operate the equipment.

NOTE: This equipment has been tested and found to comply with the limits for a Class B digital device, pursuant to Part 15 of the FCC Rules. These limits are designed to provide reasonable protection against harmful interference in a residential installation. This equipment generates, uses and can radiate radio frequency energy and, if not installed and used in accordance with the instructions, may cause harmful interference to radio communications. However, there is no guarantee that interference will not occur in a particular installation.

If this equipment does cause harmful interference to radio or television reception, which can be determined by turning the equipment off and on, the user is encouraged to try to correct the interference by one or more of the following measures:

- Reorient or relocate the receiving antenna.
- Increase the separation between the equipment and receiver.
- Connect the equipment into an outlet on a circuit different from that to which the receiver is connected.
- Consult the dealer or an experienced radio/TV technician for help.

To maintain compliance with FCC's RF Exposure guidelines, This equipment should be installed and operated with minimum distance 20cm between the radiator and your body: Use only the supplied antenna.