



中认信通

CHINA CERTIFICATION ICT CO., LTD (DONGGUAN)

ANTENNA TEST REPORT

Manufacture: Dongguan maixun electronics co., ltd

Address: 405,4th Floor,No.6, Qilin East Road, Daning Community, Humen Town,Dongguan City,China

Product Name: WIFI Antenna

Product Model: FW4907-113B-IX110A

Report Number: 2403S33016E-RF

Test Date: 2024/4/28

Tested by: Luke Yuan

Date Of Issue: 2024/4/30

Approved By: *Sun Zhong*

Test Laboratory: China Certification ICT Co., Ltd (Dongguan)

No. 113, Pingkang Road, Dalang Town, Dongguan,
Guangdong, China

Tel: +86-769-82016888

Test Facility

The Test site used by China Certification ICT Co., Ltd (Dongguan) to collect test data is located on the No. 113, Pingkang Road, Dalang Town, Dongguan, Guangdong, China.

Declarations

China Certification ICT Co., Ltd (Dongguan) is not responsible for the authenticity of any test data provided by the applicant. Data included from the applicant that may affect test results are marked with a triangle symbol “▲”. Customer model name, addresses, names, trademarks etc. are not considered data.

Unless otherwise stated the results shown in this test report refer only to the sample(s) tested.

This report cannot be reproduced except in full, without prior written approval of the Company.

This report is valid only with a valid digital signature. The digital signature may be available only under the Adobe software above version 7.0.

This report may contain data that are not covered by the accreditation scope and shall be marked with an asterisk “★”.

CONTENTS

DOCUMENT REVISION HISTORY	4
1. GENERAL INFORMATION.....	5
2. TEST CONFIGURATIONS.....	6
2.1 TEST ENVIRONMENT.....	6
2.2 TEST ENVIRONMENT.....	6
3. TEST RESULTS.....	7
3.1 GAIN AND EFFICIENCY	7
3.2 RADIATION PATTERN	9
4. EUT PHOTOGRAPHS	56
5. TEST SETUP PHOTOGRAPHS.....	57

DOCUMENT REVISION HISTORY

Revision Number	Report Number	Description of Revision	Date of Revision
1.0	2403S33016E-RF	Original Report	2024/4/30

1. GENERAL INFORMATION

Product Name:	WIFI Antenna
Product Model:	FW4907-113B-IX110A
Antenna Type:	PCB
Test Items:	Gain; Efficiency; Radiation Pattern
Test Frequency(MHz):	2400MHz to 2500 MHz step 10 MHz; 5150MHz to 5850 MHz step 20 MHz
Serial Number:	2KGQ-1
EUT Received Date:	2024.4.30
EUT Received Status:	Good

2. TEST CONFIGURATIONS

2.1 Test Environment

Temperature (°C)	24.0
Humidity (%RH)	68.0
Atmospheric Pressure (kPa)	100.5

2.2 Test Environment

Test Instrument	R&S ZNB8
------------------------	----------

3. TEST RESULTS

3.1 Gain and Efficiency

Frequency (MHz)	Peak Gain (dBi)	Efficiency (%)
2400.0	3.47	46.74
2410.0	3.29	44.44
2420.0	3.17	43.22
2430.0	3.26	42.17
2440.0	3.40	40.88
2450.0	3.18	38.69
2460.0	3.46	39.87
2470.0	3.23	39.07
2480.0	3.13	37.76
2490.0	3.43	40.77
2500.0	3.31	40.96
5150.0	1.89	43.05
5170.0	1.84	43.5
5190.0	1.45	40.79
5210.0	1.47	41.72
5230.0	1.54	43.53
5250.0	1.51	43.49
5270.0	1.62	45.18
5290.0	1.70	45.90
5310.0	1.78	45.99
5330.0	2.00	47.30
5350.0	1.82	45.04
5370.0	1.77	43.17
5390.0	1.76	43.81
5410.0	1.71	42.59
5430.0	1.61	42.58

5450.0	1.84	44.27
5470.0	1.77	42.88
5490.0	1.91	44.50
5510.0	2.06	46.41
5530.0	1.96	44.09
5550.0	1.66	43.91
5570.0	1.77	45.34
5590.0	1.51	45.12
5610.0	1.40	45.46
5630.0	1.30	43.88
5650.0	1.55	46.17
5670.0	1.43	44.79
5690.0	1.38	43.79
5710.0	1.35	44.58
5730.0	1.28	42.74
5750.0	1.06	42.62
5770.0	1.26	41.57
5790.0	1.11	41.61
5810.0	1.23	42.57
5830.0	1.28	43.48
5850.0	1.18	42.93

3.2 Radiation Pattern

2400MHz 3D

Theta = 90, Phi = 0

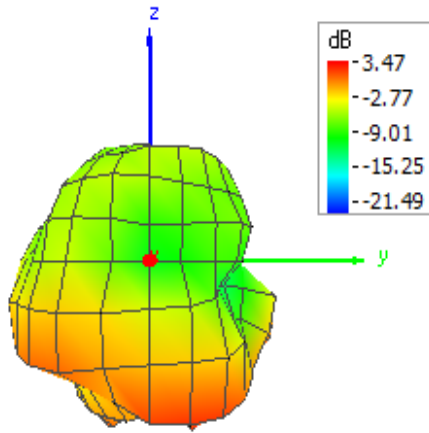

Theta = 90, Phi = 90

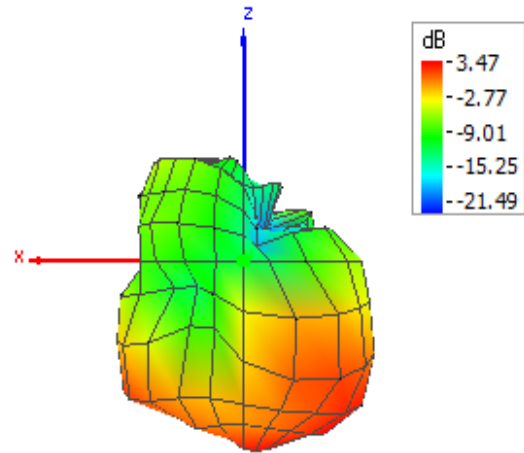

Theta = 0, Phi = 0

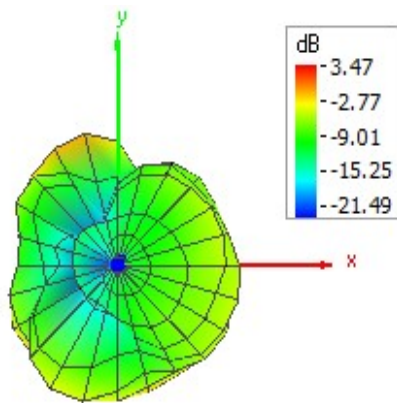

Theta = 90, Phi = 180

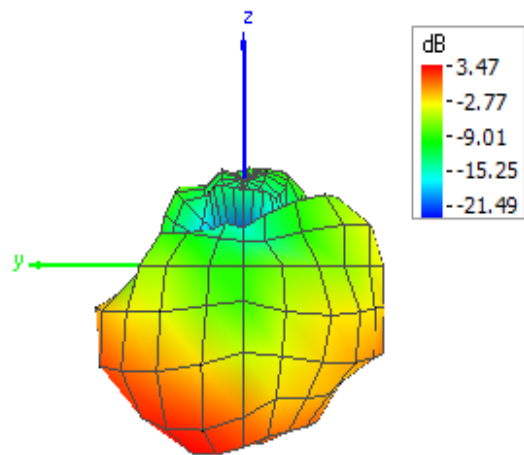

Theta = 90, Phi = 270

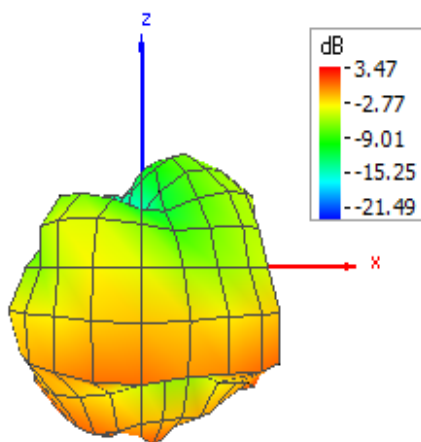

Theta = 180, Phi = 0

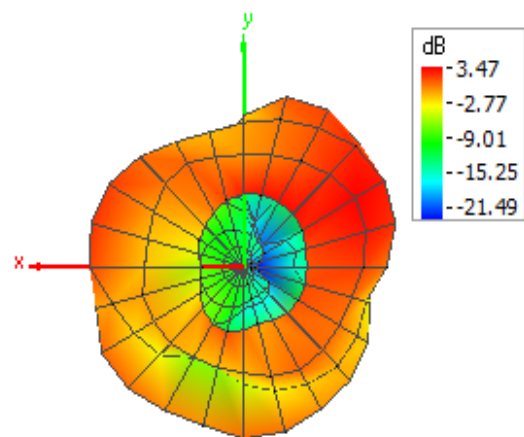

2410MHz 3D

Theta = 90, Phi = 0

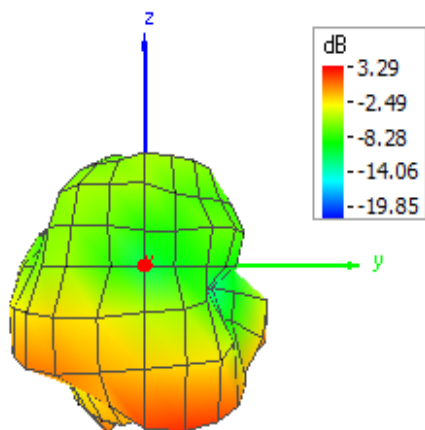

Theta = 90, Phi = 90

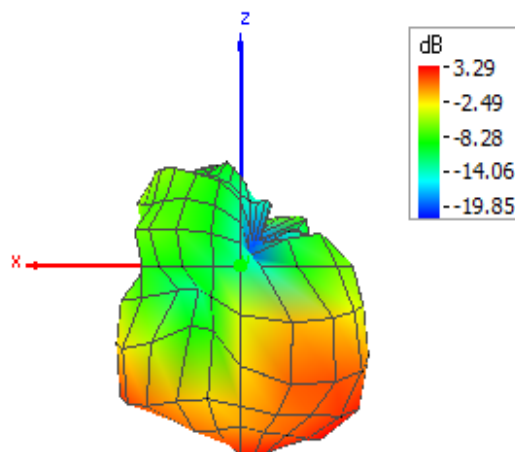

Theta = 0, Phi = 0

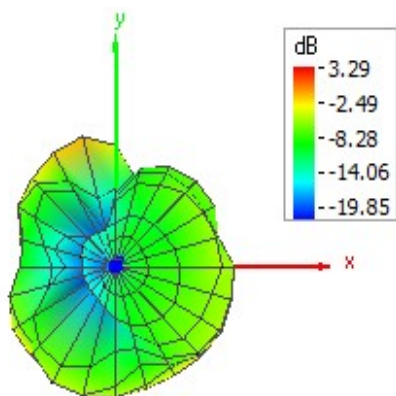

Theta = 90, Phi = 180

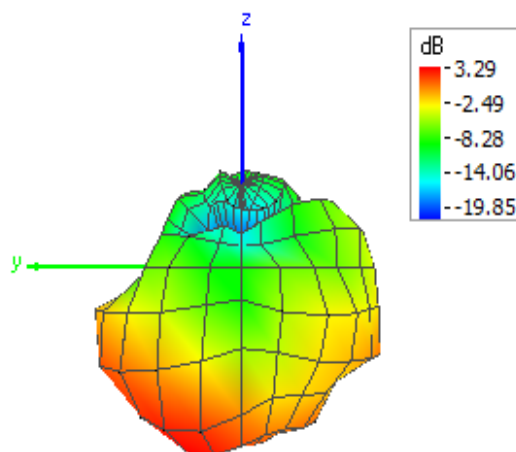

Theta = 90, Phi = 270

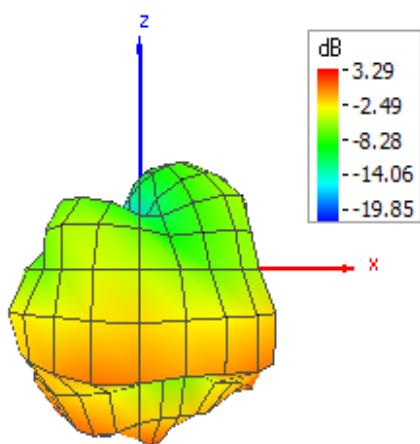

Theta = 180, Phi = 0

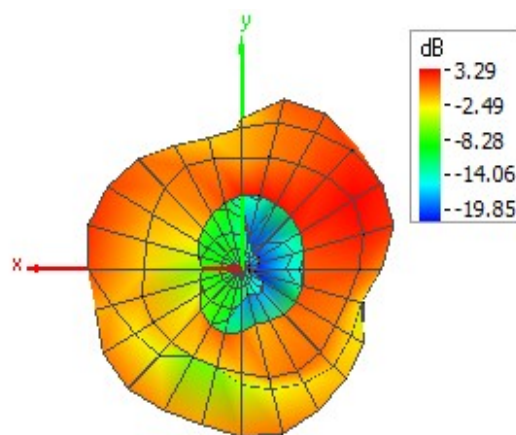

2420MHz 3D

Theta = 90, Phi = 0

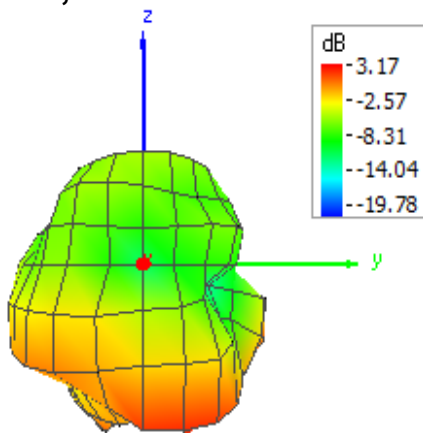

Theta = 90, Phi = 90

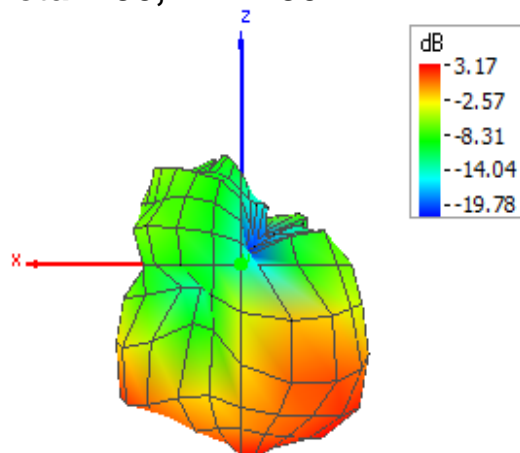

Theta = 0, Phi = 0

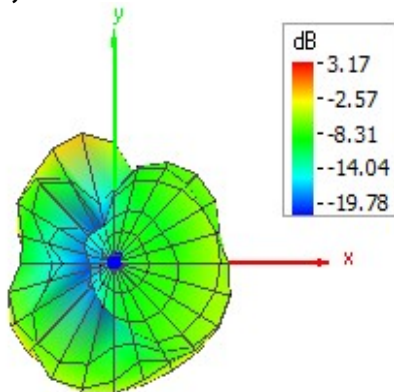

Theta = 90, Phi = 180

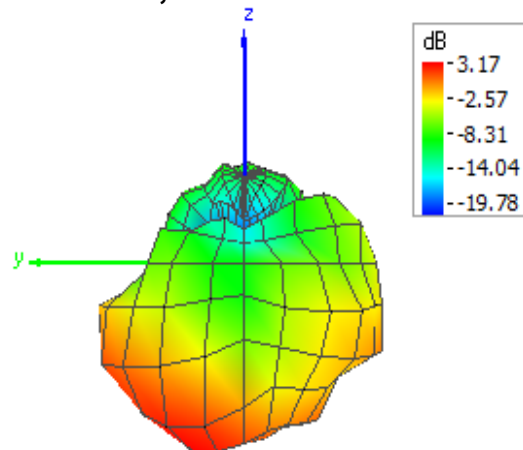

Theta = 90, Phi = 270

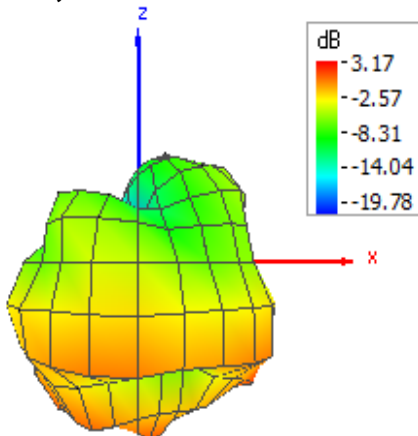

Theta = 180, Phi = 0

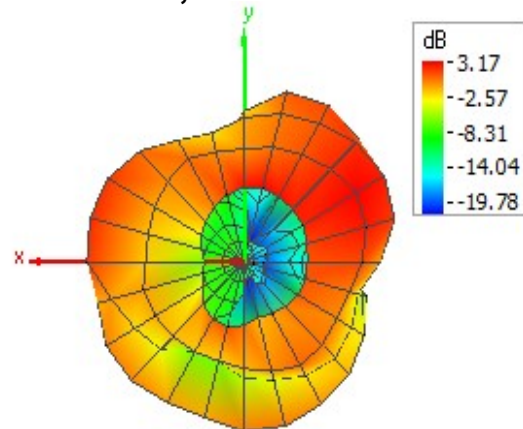

2430MHz 3D

Theta = 90, Phi = 0

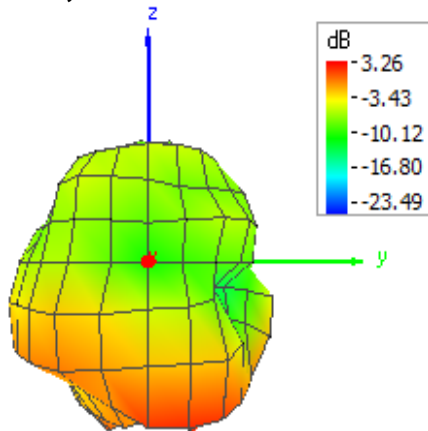

Theta = 90, Phi = 90

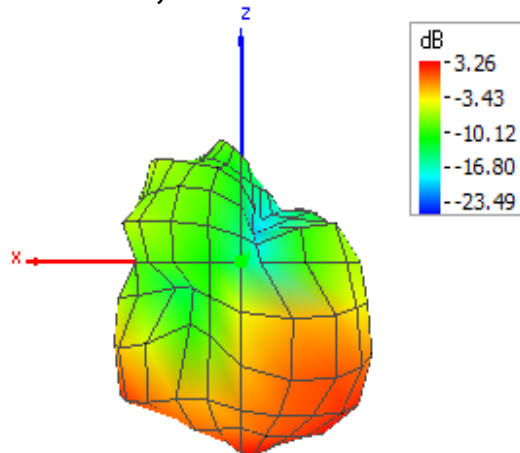

Theta = 0, Phi = 0

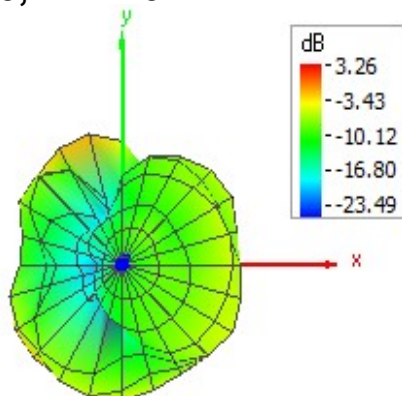

Theta = 90, Phi = 180

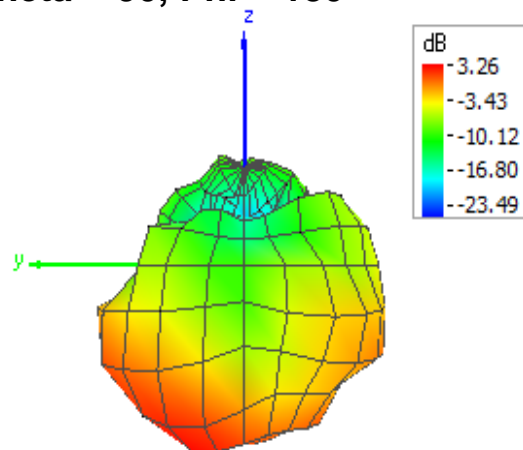

Theta = 90, Phi = 270

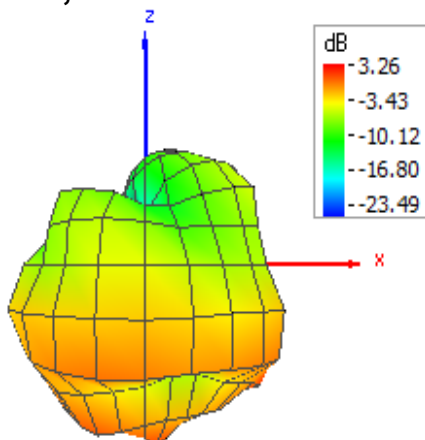

Theta = 180, Phi = 0

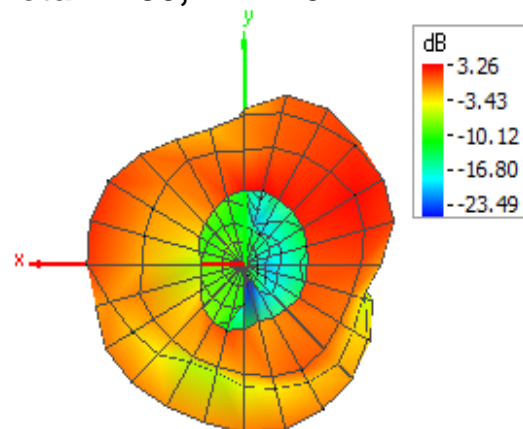

2440MHz 3D

Theta = 90, Phi = 0

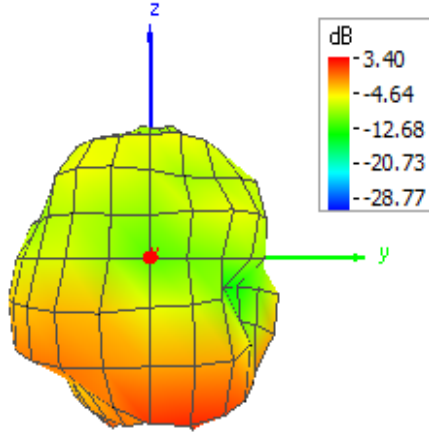

Theta = 90, Phi = 90

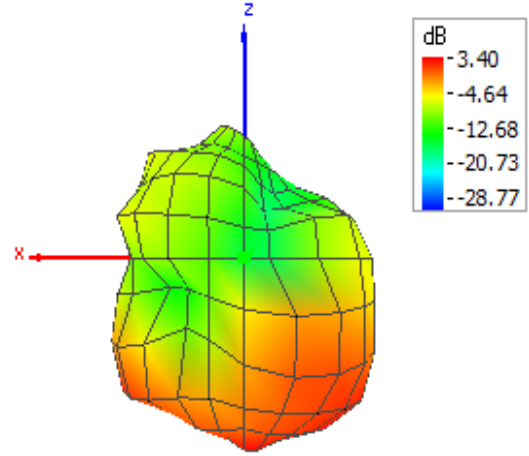

Theta = 0, Phi = 0

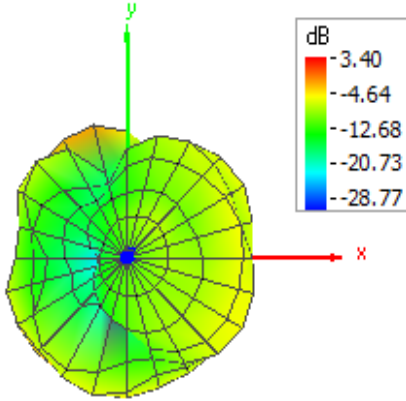

Theta = 90, Phi = 180

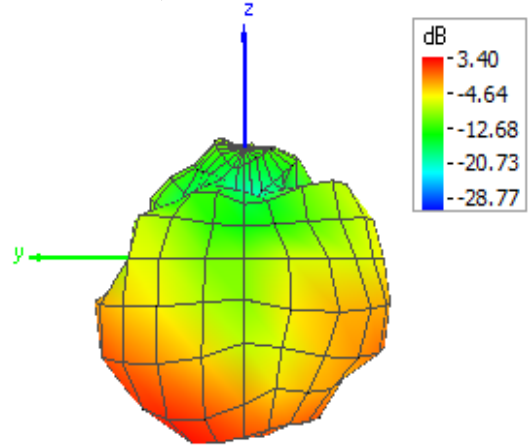

Theta = 90, Phi = 270

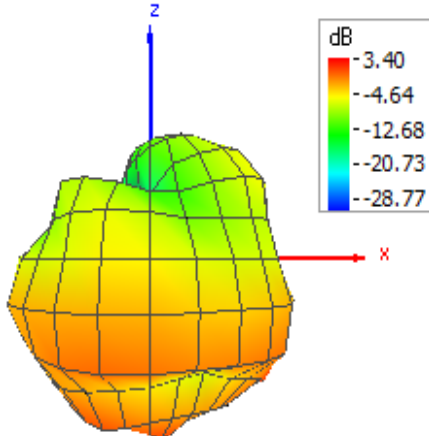

Theta = 180, Phi = 0

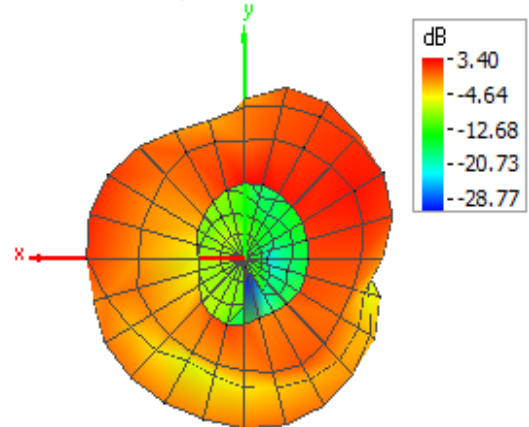

2450MHz 3D

Theta = 90, Phi = 0

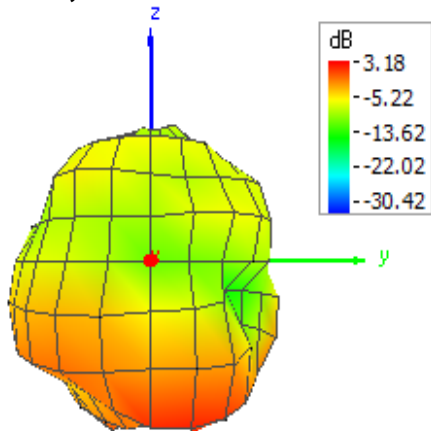

Theta = 90, Phi = 90

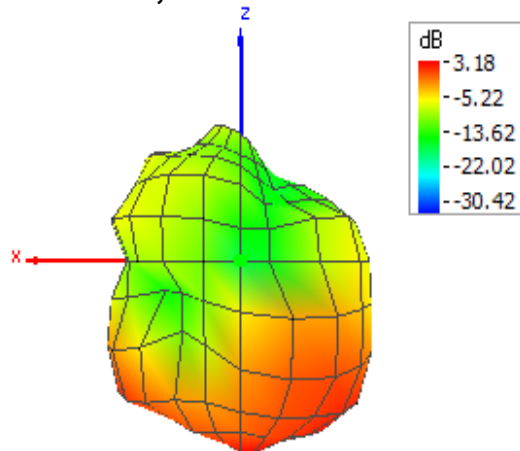

Theta = 0, Phi = 0

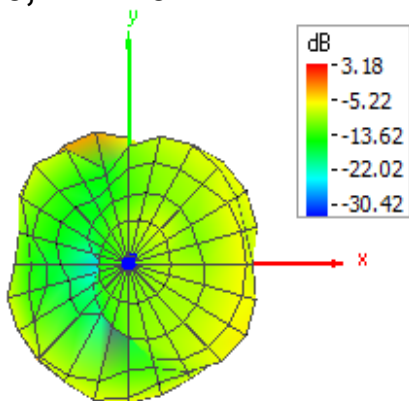

Theta = 90, Phi = 180

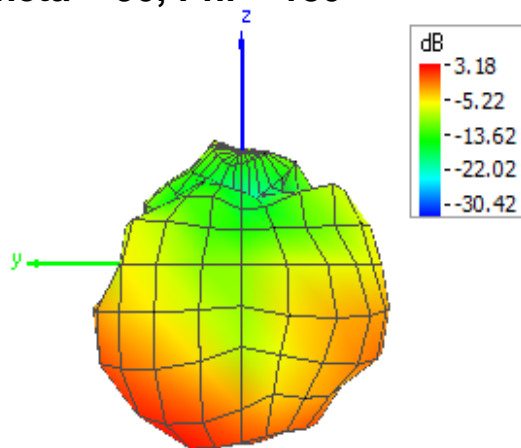

Theta = 90, Phi = 270

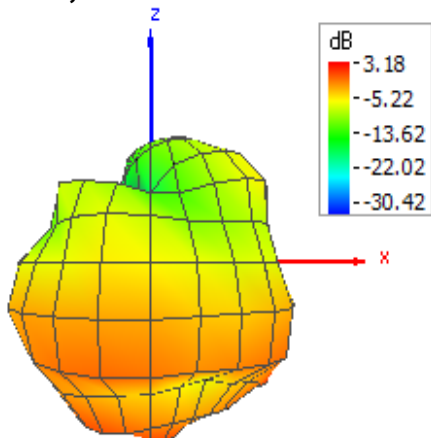

Theta = 180, Phi = 0

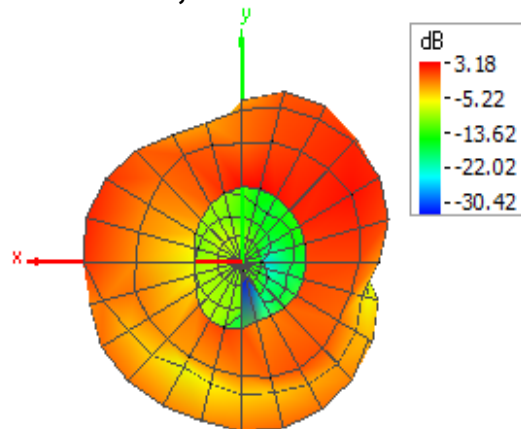

2460MHz 3D

Theta = 90, Phi = 0

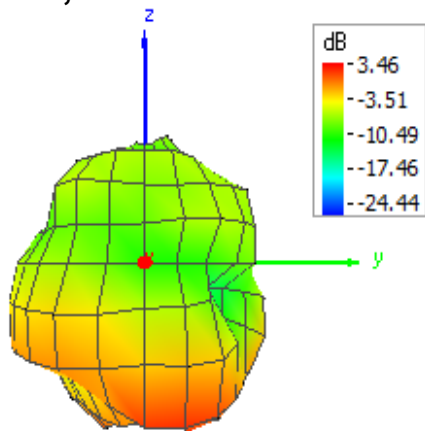

Theta = 90, Phi = 90

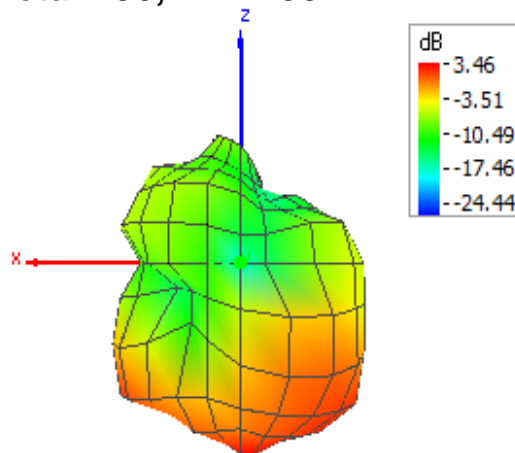

Theta = 0, Phi = 0

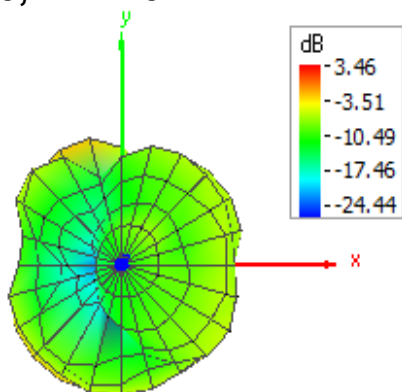

Theta = 90, Phi = 180

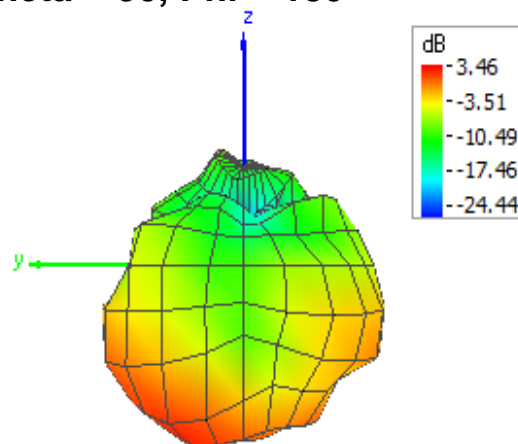

Theta = 90, Phi = 270

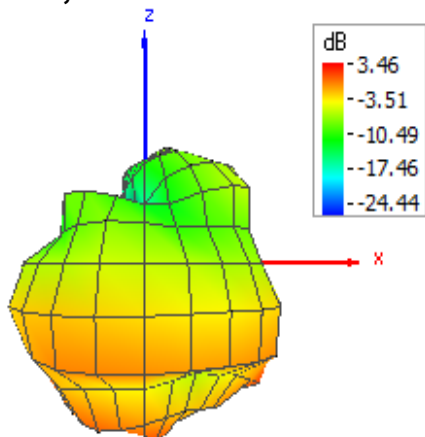

Theta = 180, Phi = 0

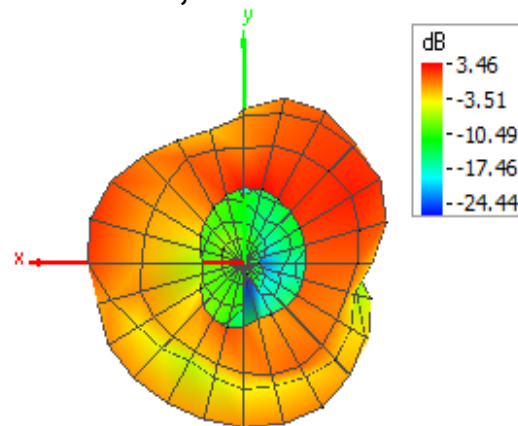

2470MHz 3D

Theta = 90, Phi = 0

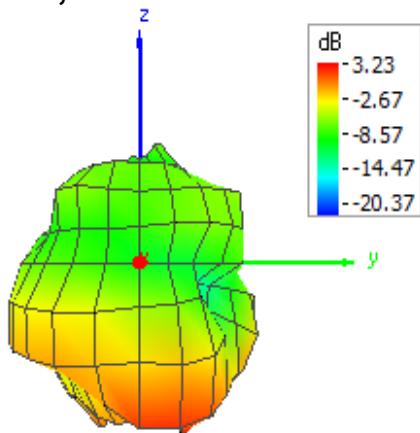

Theta = 90, Phi = 90

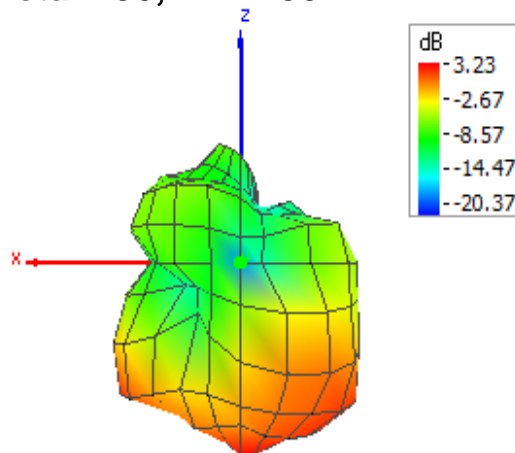

Theta = 0, Phi = 0

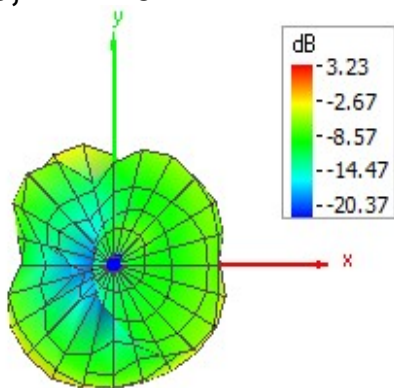

Theta = 90, Phi = 180

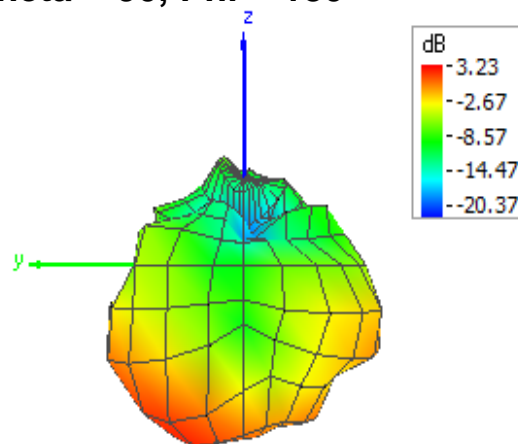

Theta = 90, Phi = 270

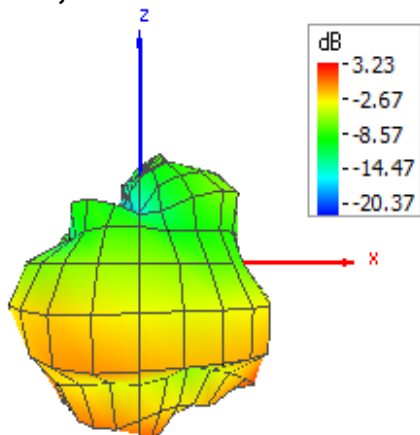

Theta = 180, Phi = 0

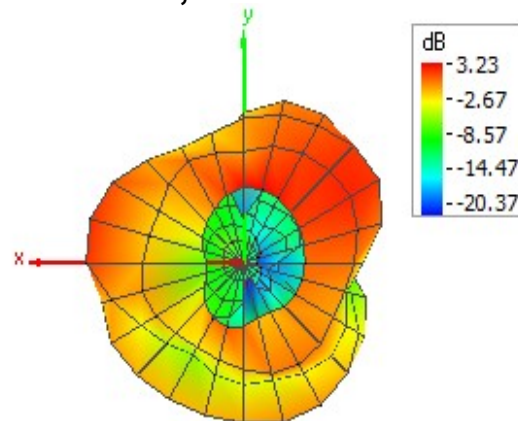

2480MHz 3D

Theta = 90, Phi = 0

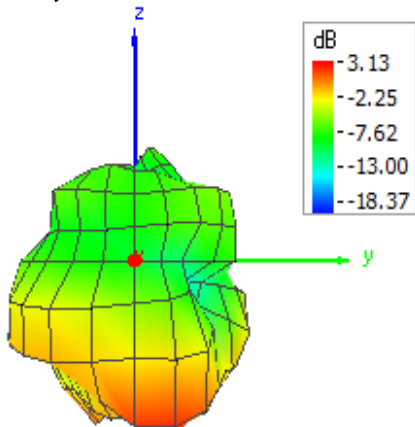

Theta = 90, Phi = 90

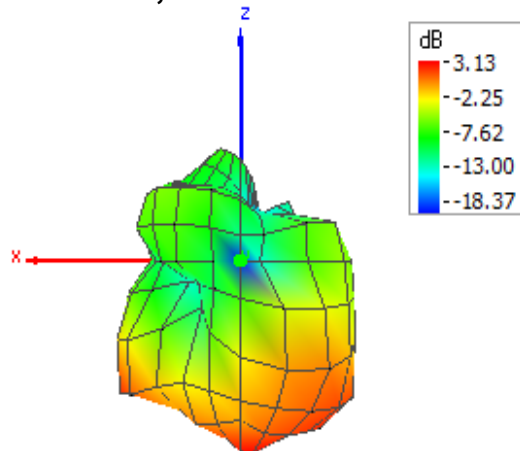

Theta = 0, Phi = 0

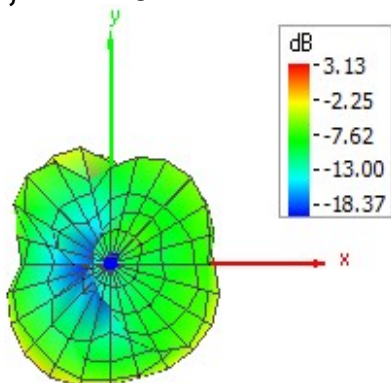

Theta = 90, Phi = 180

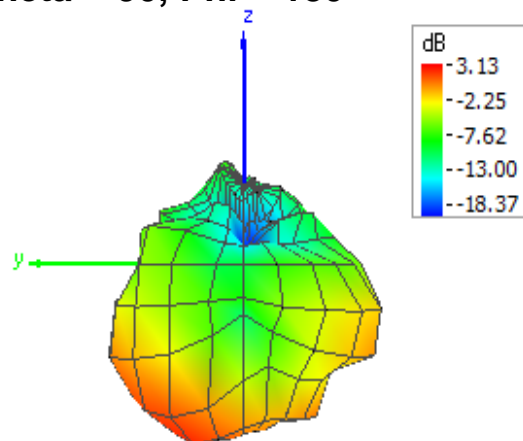

Theta = 90, Phi = 270

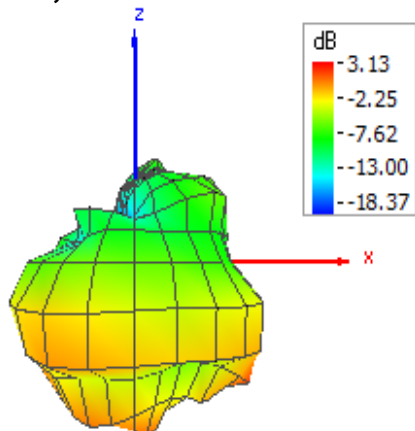

Theta = 180, Phi = 0

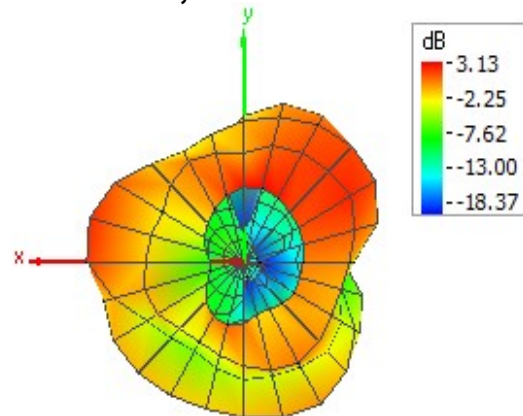

2490MHz 3D

Theta = 90, Phi = 0

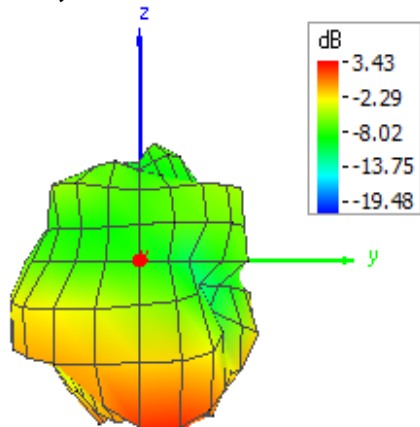

Theta = 90, Phi = 90

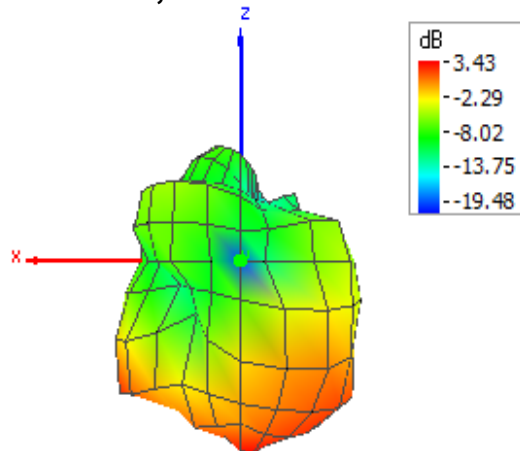

Theta = 0, Phi = 0

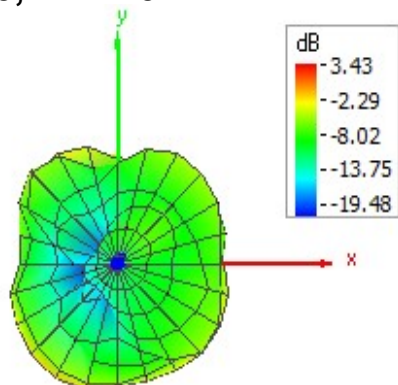

Theta = 90, Phi = 180

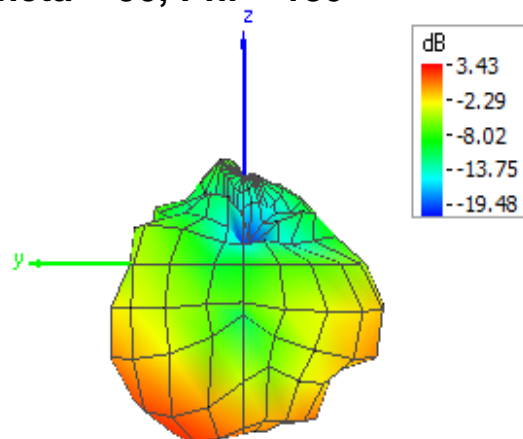

Theta = 90, Phi = 270

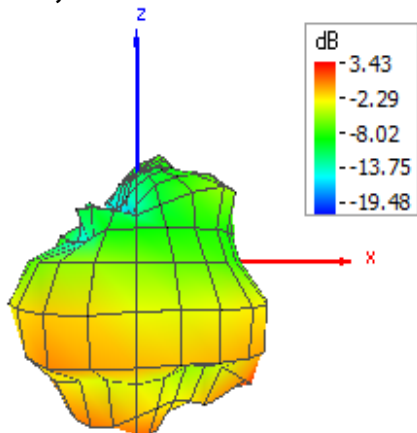

Theta = 180, Phi = 0

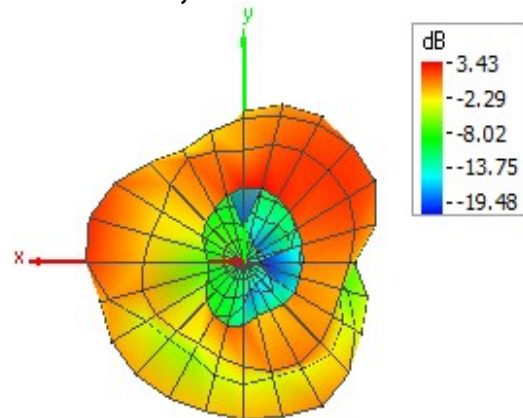

2500MHz 3D

Theta = 90, Phi = 0

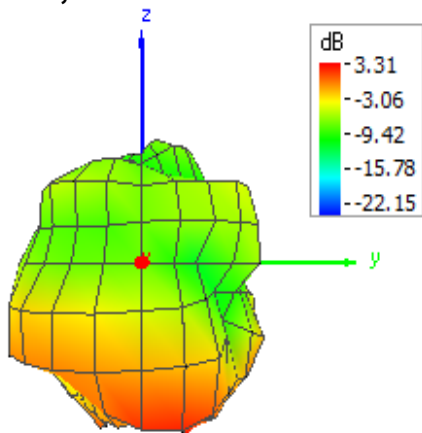

Theta = 90, Phi = 90

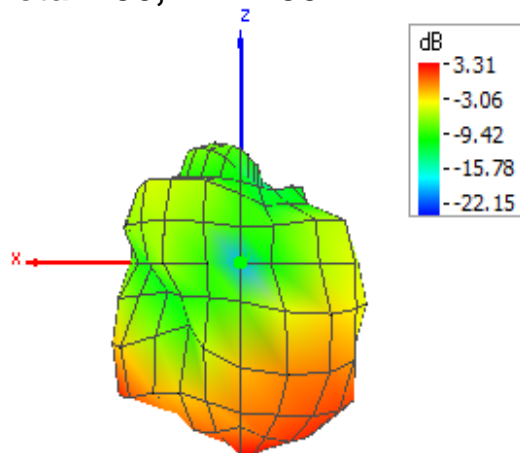

Theta = 0, Phi = 0

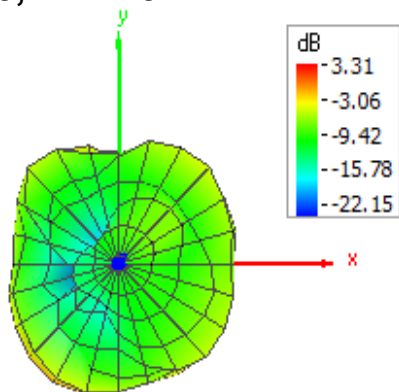

Theta = 90, Phi = 180

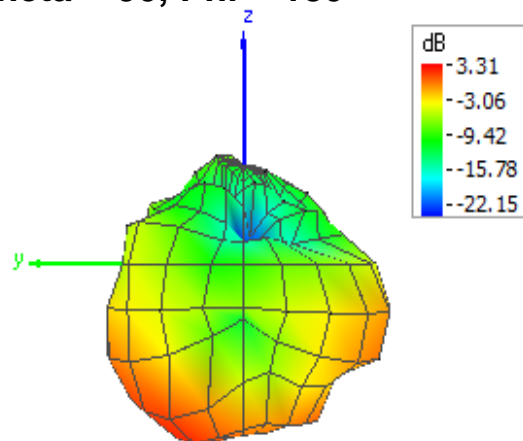

Theta = 90, Phi = 270

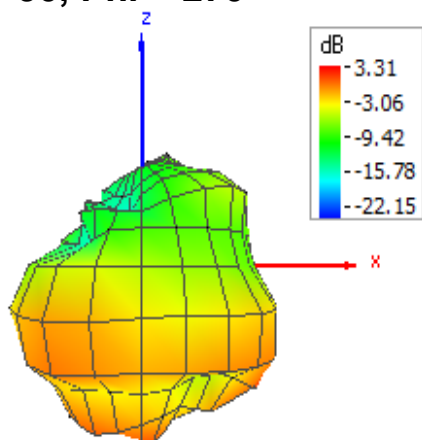

Theta = 180, Phi = 0

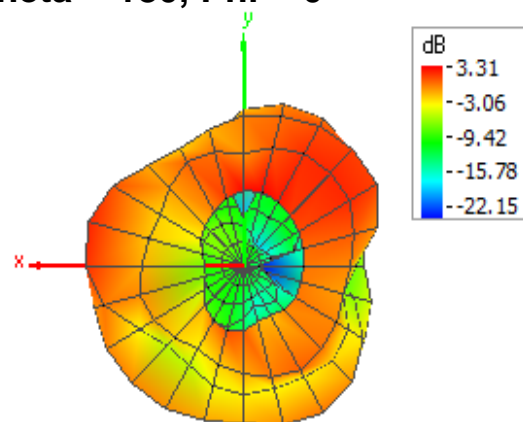

5150MHz 3D

Theta = 90, Phi = 0

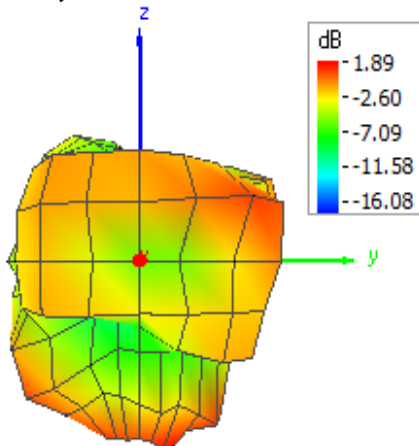

Theta = 90, Phi = 90

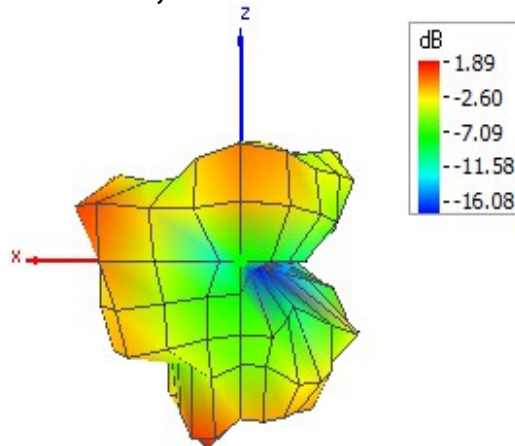

Theta = 0, Phi = 0

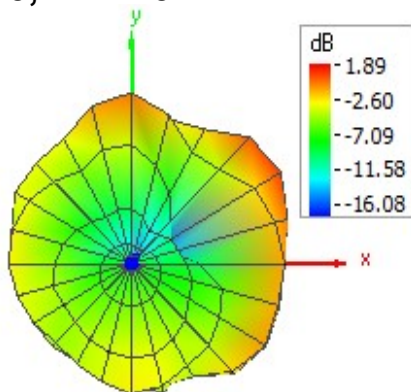

Theta = 90, Phi = 180

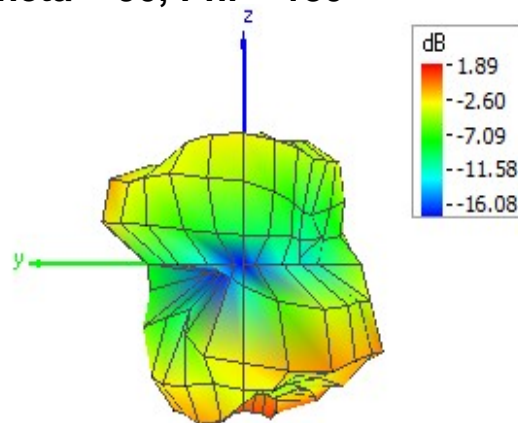

Theta = 90, Phi = 270

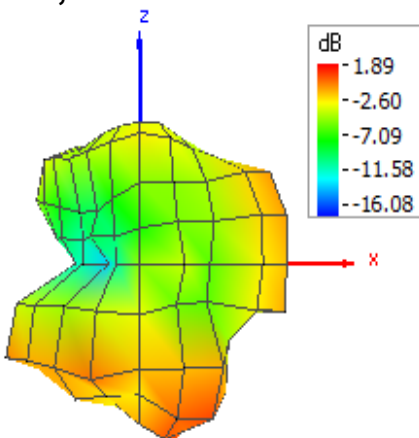

Theta = 180, Phi = 0

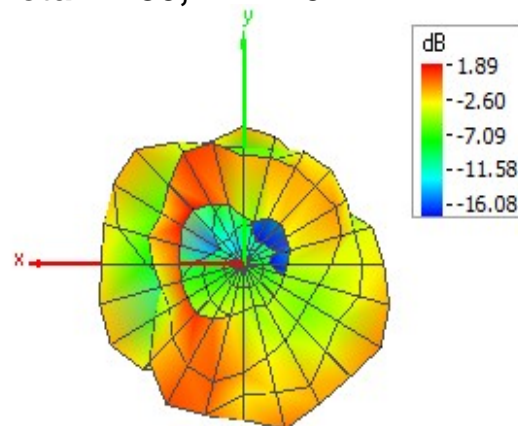

5170MHz 3D

Theta = 90, Phi = 0

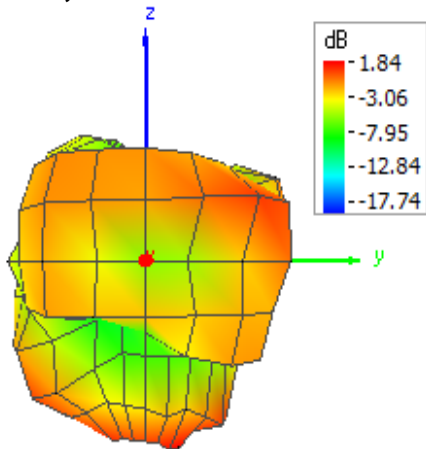

Theta = 90, Phi = 90

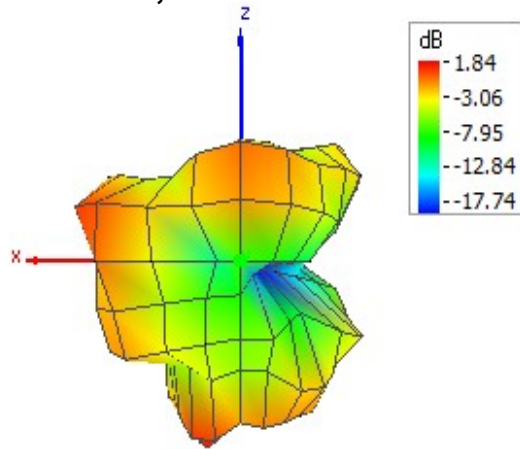

Theta = 0, Phi = 0

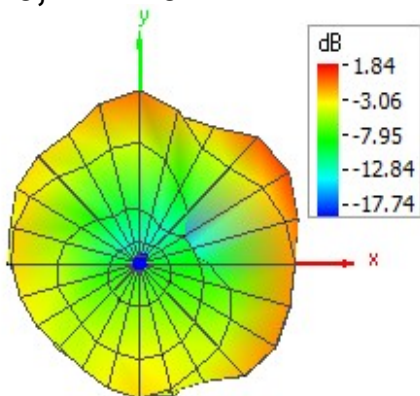

Theta = 90, Phi = 180

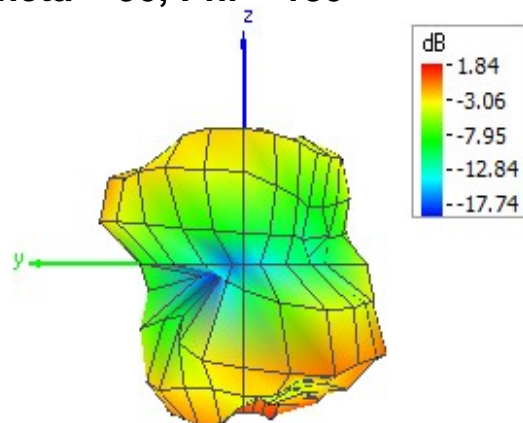

Theta = 90, Phi = 270

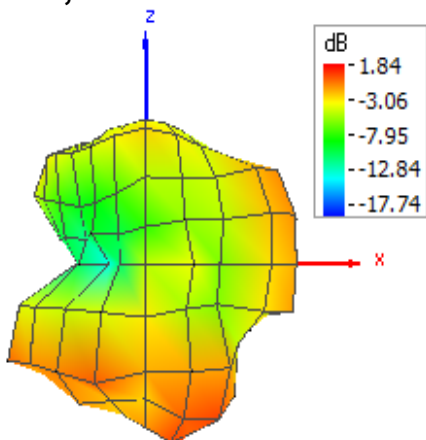

Theta = 180, Phi = 0

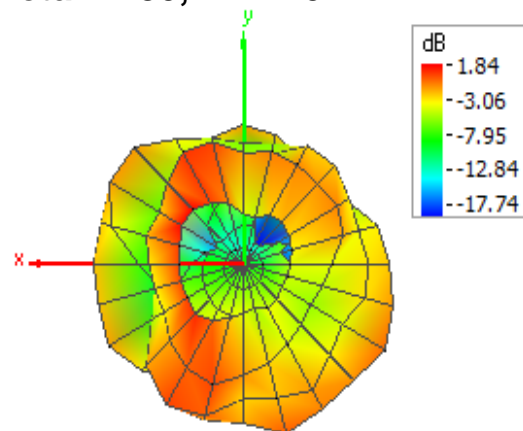

5190MHz 3D

Theta = 90, Phi = 0

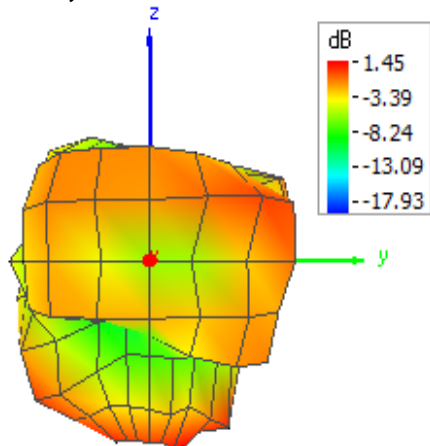

Theta = 90, Phi = 90

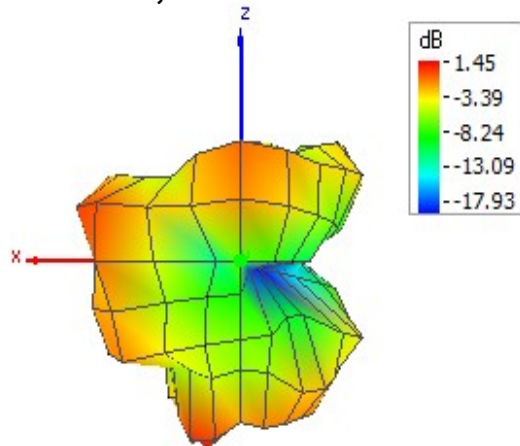

Theta = 0, Phi = 0

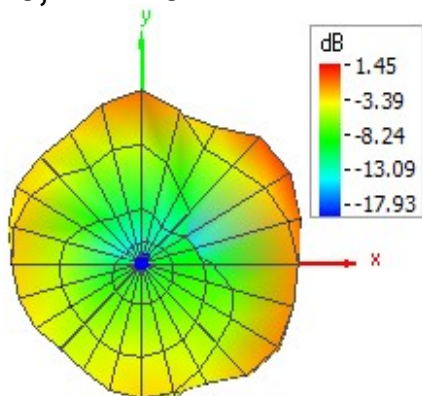

Theta = 90, Phi = 180

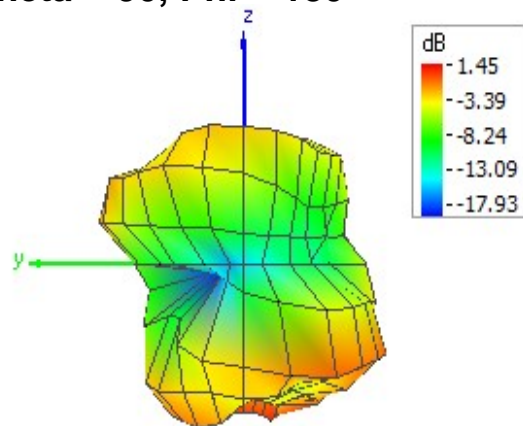

Theta = 90, Phi = 270

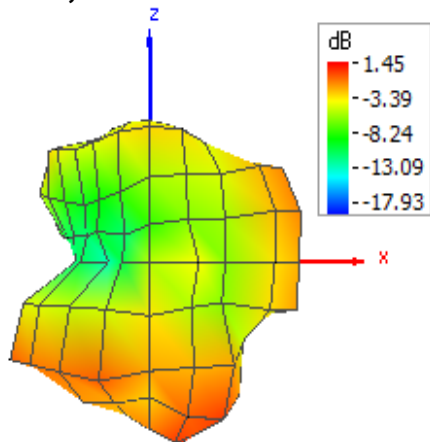

Theta = 180, Phi = 0

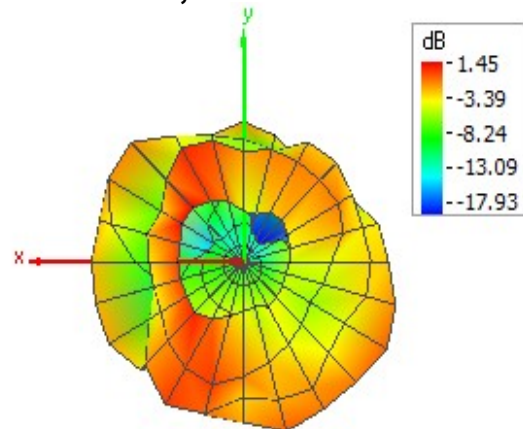

5210MHz 3D

Theta = 90, Phi = 0

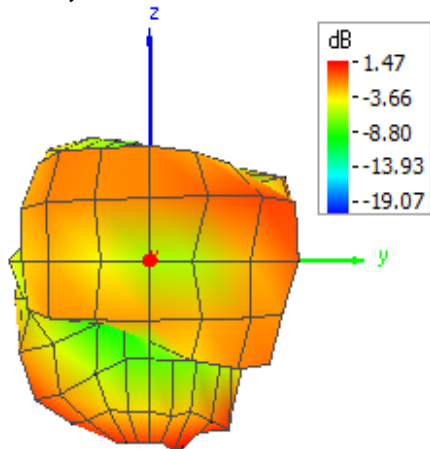

Theta = 90, Phi = 90

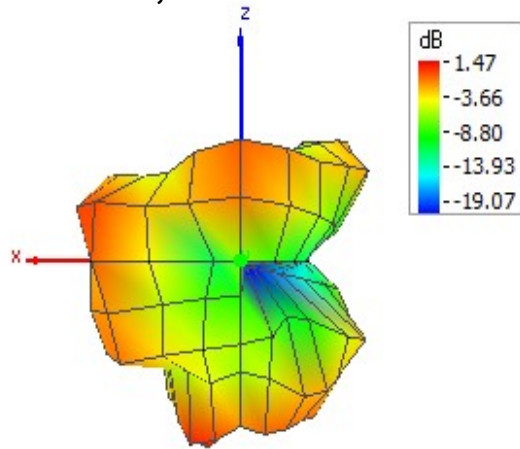

Theta = 0, Phi = 0

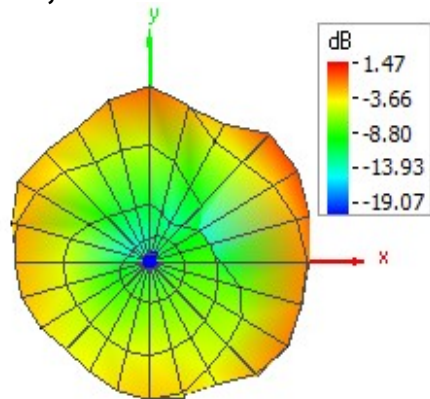

Theta = 90, Phi = 180

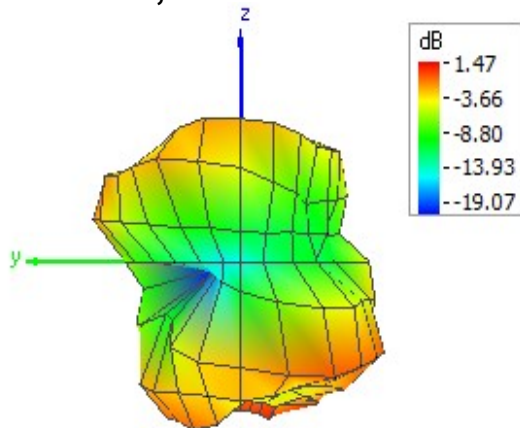

Theta = 90, Phi = 270

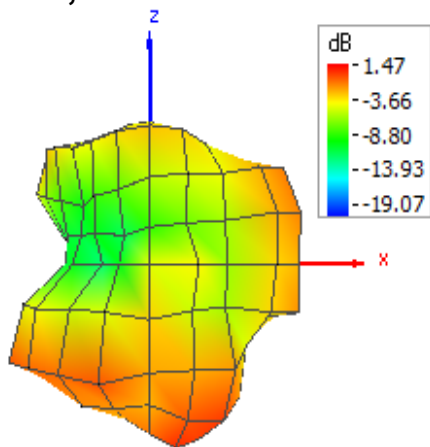

Theta = 180, Phi = 0

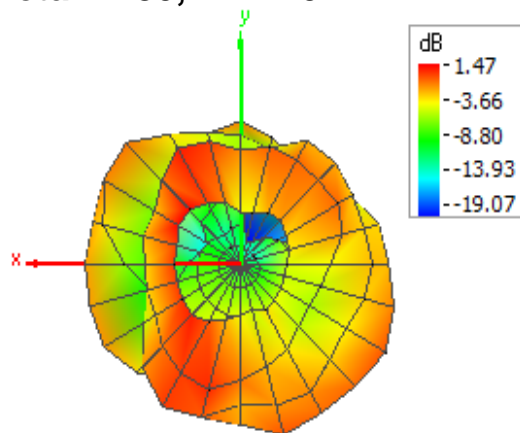

5230MHz 3D

Theta = 90, Phi = 0

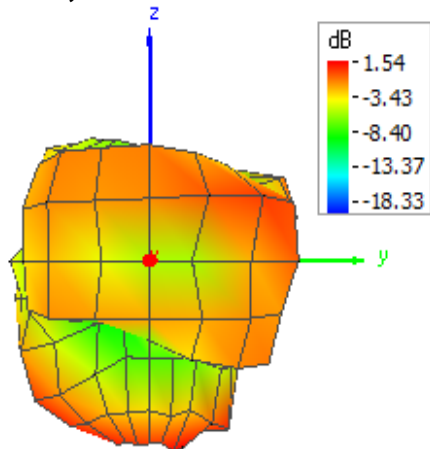

Theta = 90, Phi = 90

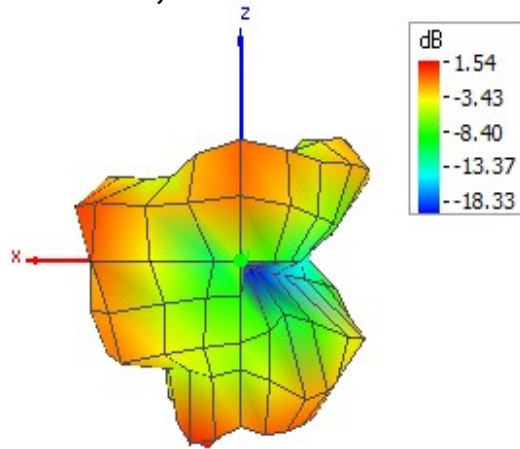

Theta = 0, Phi = 0

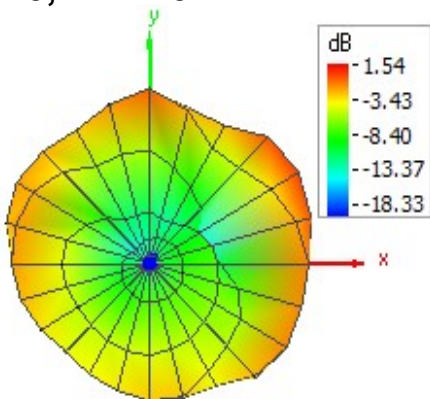

Theta = 90, Phi = 180

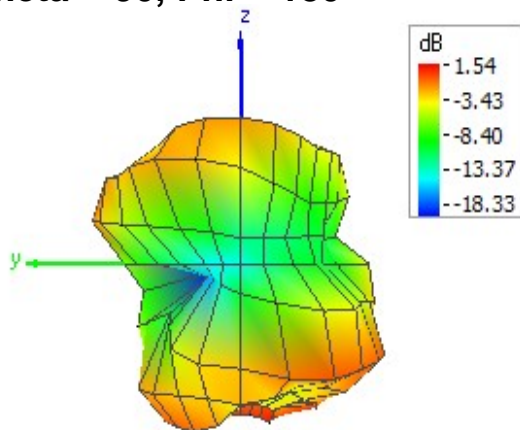

Theta = 90, Phi = 270

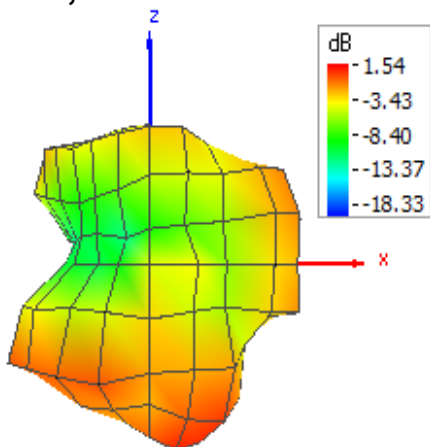

Theta = 180, Phi = 0

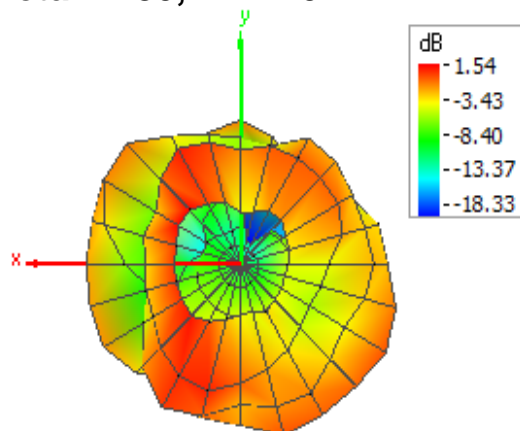

5250MHz 3D

Theta = 90, Phi = 0

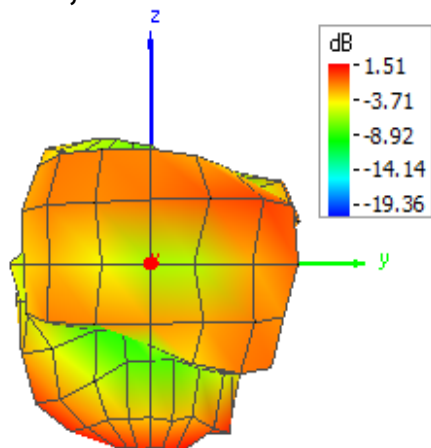

Theta = 90, Phi = 90

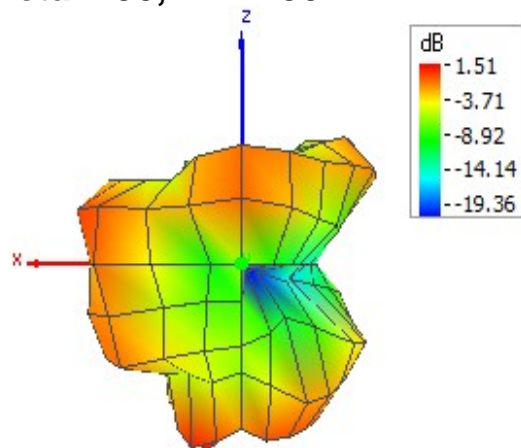

Theta = 0, Phi = 0

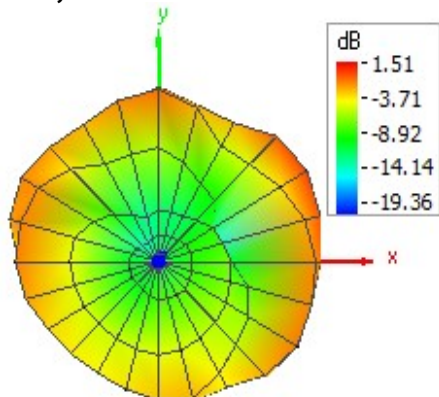

Theta = 90, Phi = 180

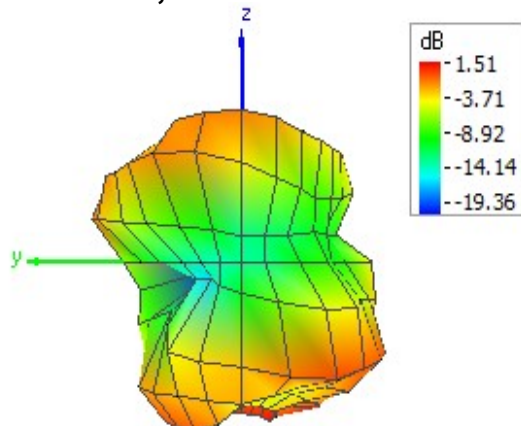

Theta = 90, Phi = 270

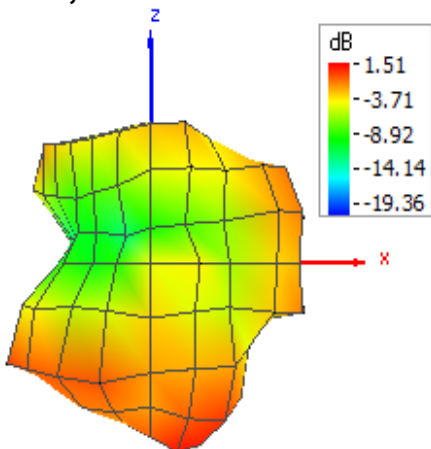

Theta = 180, Phi = 0

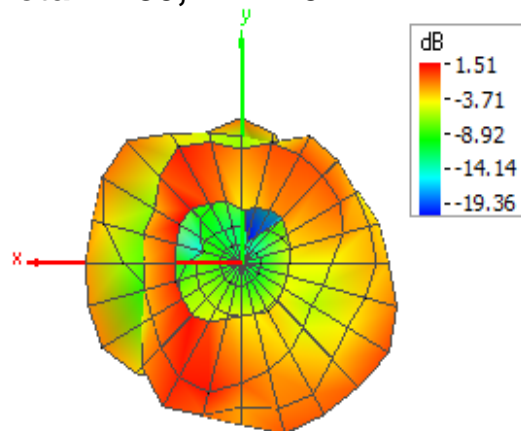

5270MHz 3D

Theta = 90, Phi = 0

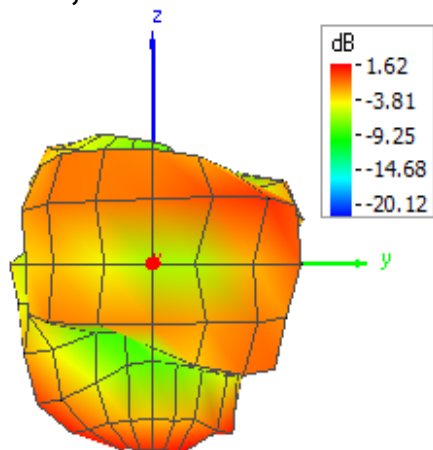

Theta = 90, Phi = 90

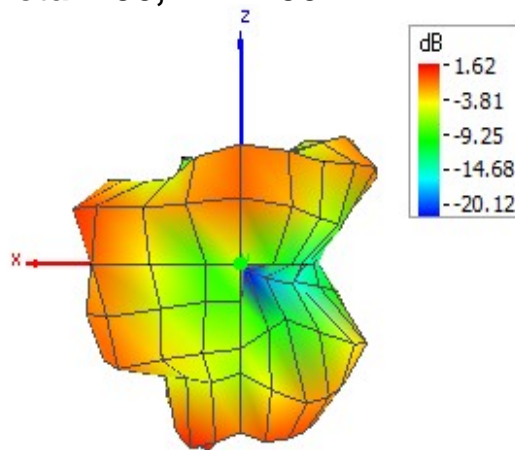

Theta = 0, Phi = 0

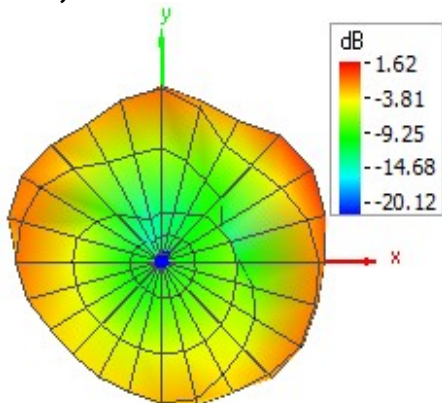

Theta = 90, Phi = 180

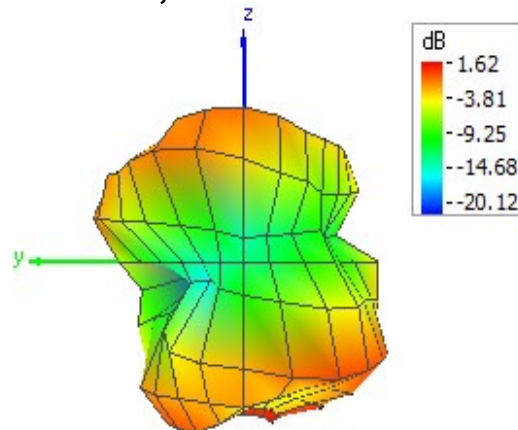

Theta = 90, Phi = 270

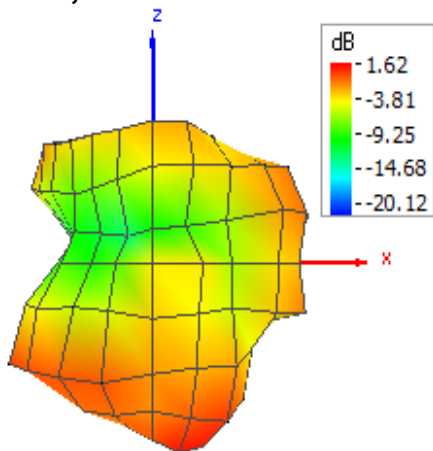

Theta = 180, Phi = 0

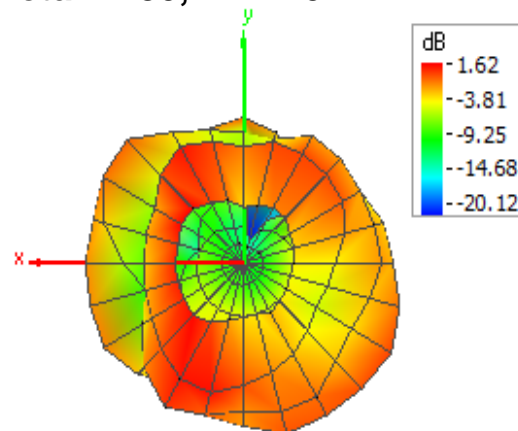

5290MHz 3D

Theta = 90, Phi = 0

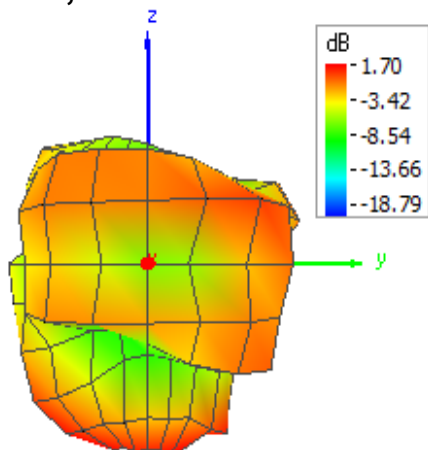

Theta = 90, Phi = 90

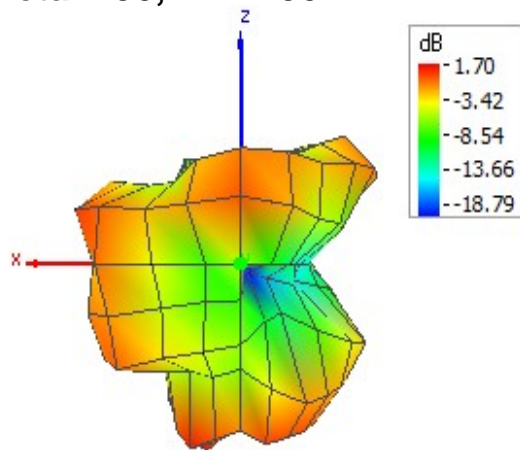

Theta = 0, Phi = 0

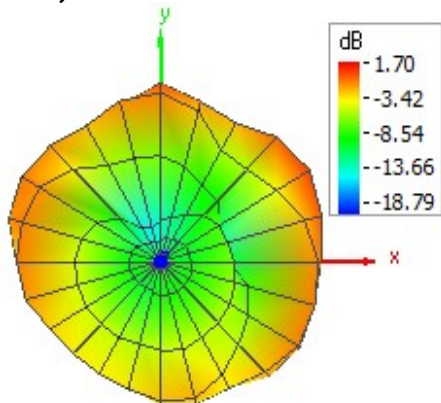

Theta = 90, Phi = 180

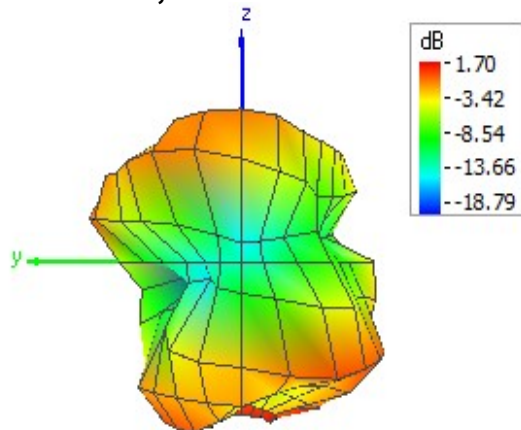

Theta = 90, Phi = 270

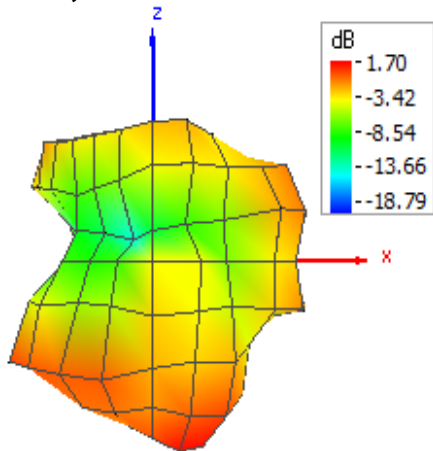

Theta = 180, Phi = 0

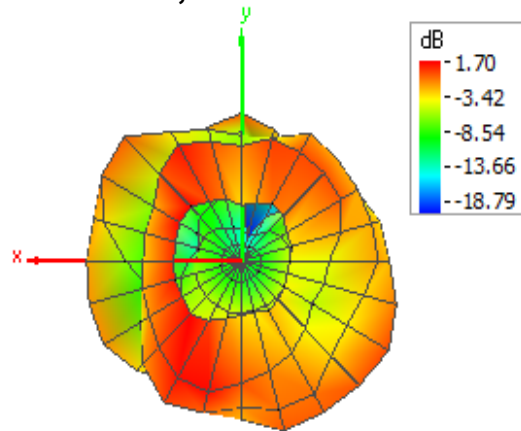

5310MHz 3D

Theta = 90, Phi = 0

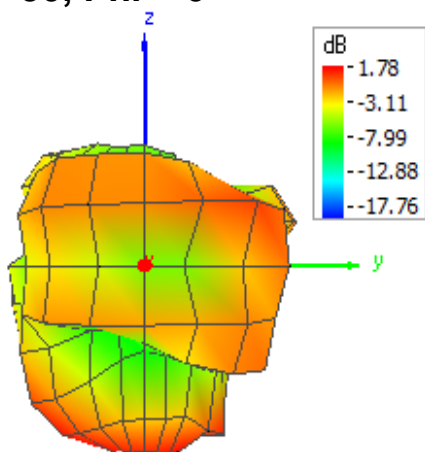

Theta = 90, Phi = 90

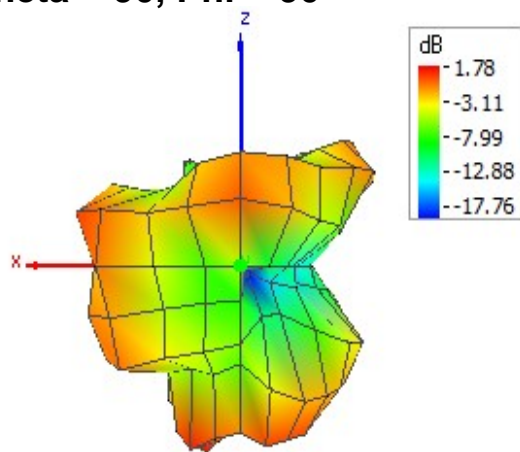

Theta = 0, Phi = 0

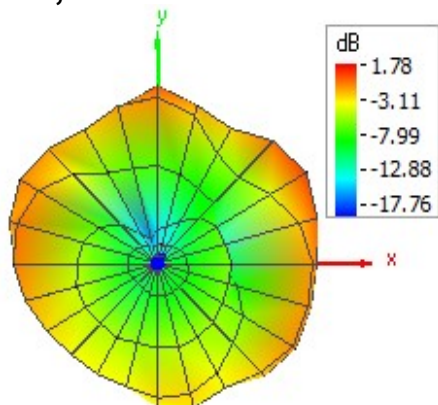

Theta = 90, Phi = 180

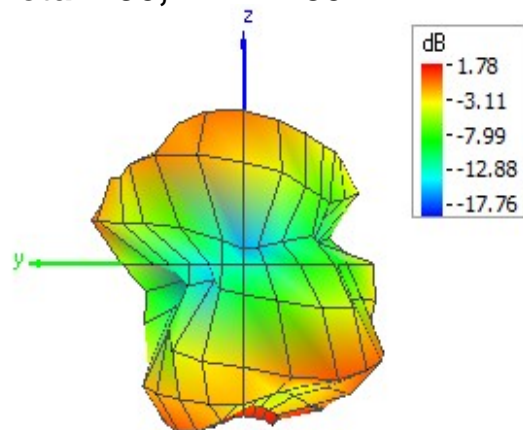

Theta = 90, Phi = 270

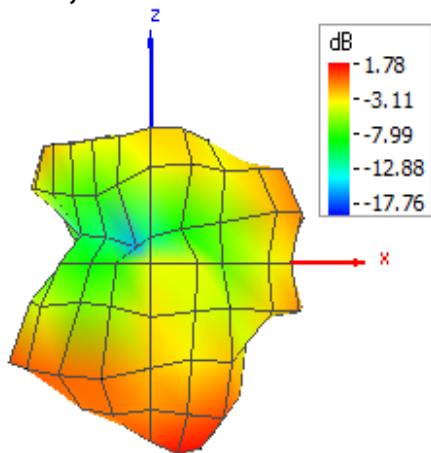

Theta = 180, Phi = 0

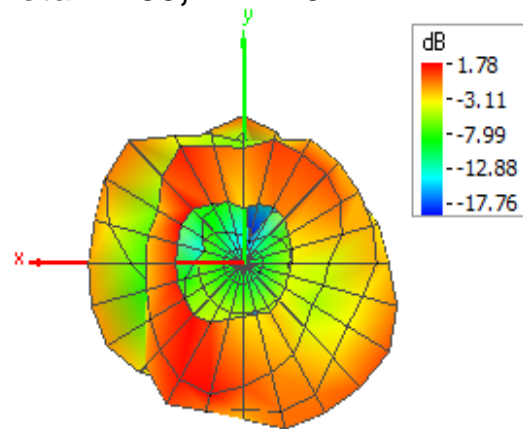

5330MHz 3D

Theta = 90, Phi = 0

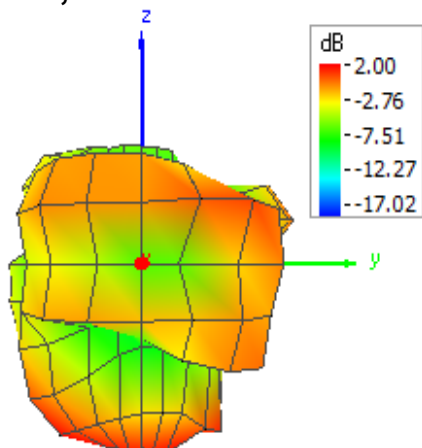

Theta = 90, Phi = 90

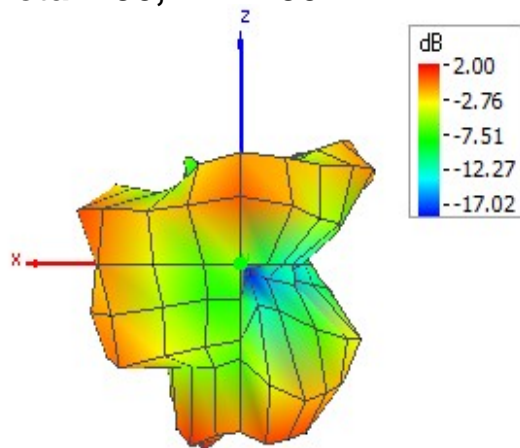

Theta = 0, Phi = 0

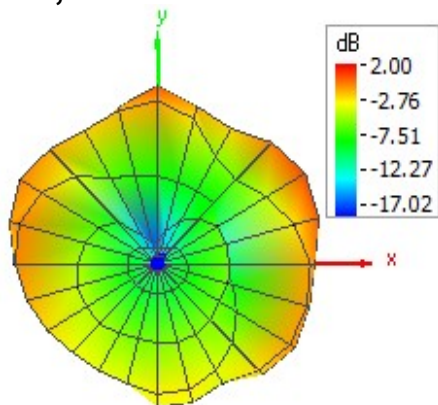

Theta = 90, Phi = 180

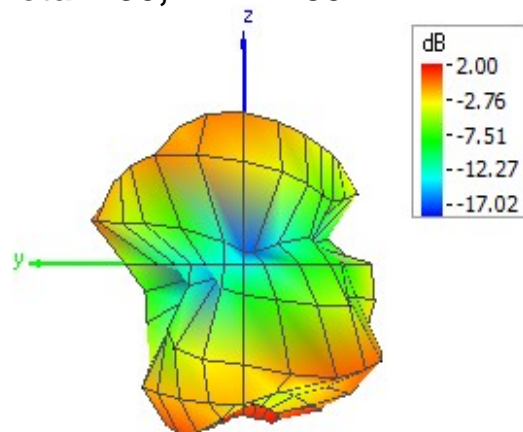

Theta = 90, Phi = 270

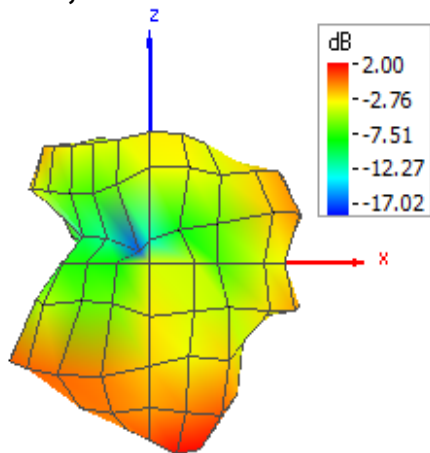

Theta = 180, Phi = 0

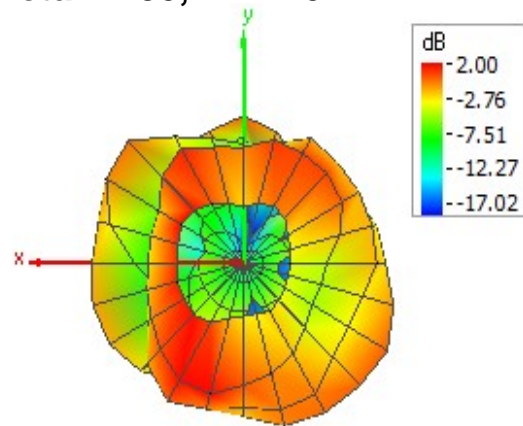

5350MHz 3D

Theta = 90, Phi = 0

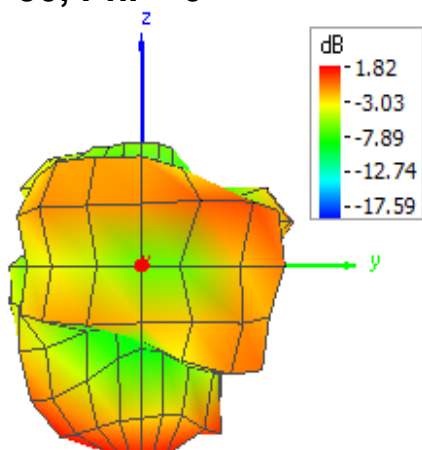

Theta = 90, Phi = 90

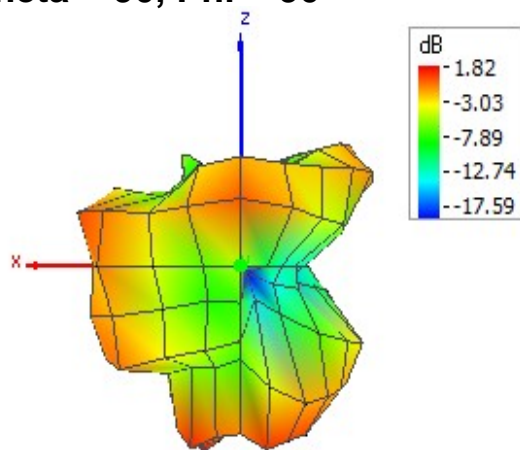

Theta = 0, Phi = 0

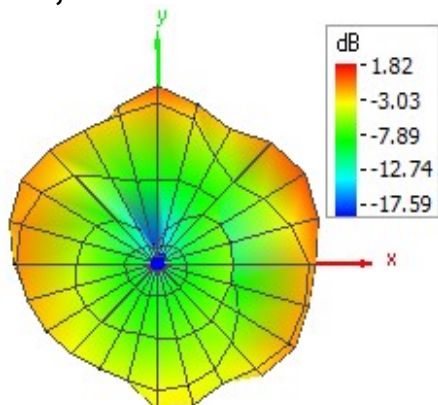

Theta = 90, Phi = 180

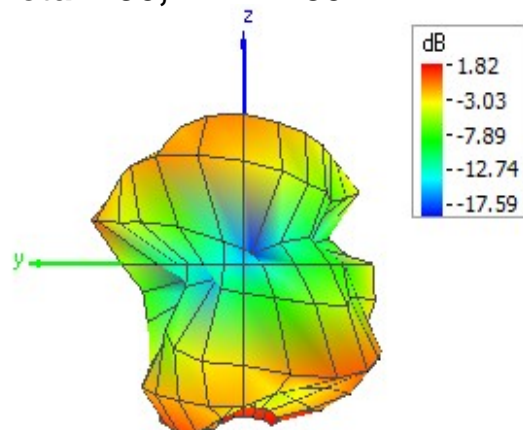

Theta = 90, Phi = 270

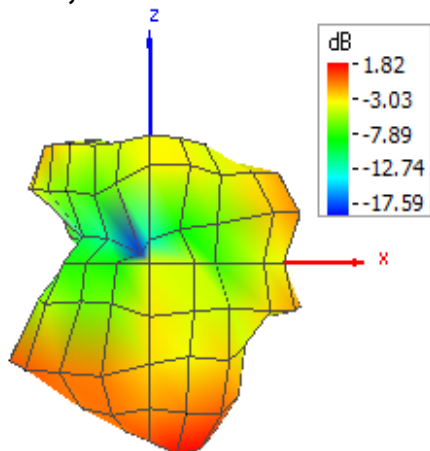

Theta = 180, Phi = 0

