

# FCC Test Report

**Applicant** : **SprintRay Inc**

---

**Address** : **2710 Media Center Dr, Suite 100A, Los Angeles,  
CA, 90065-1700, United States**

---

**Product Name** : **Midas**

---

**Report Date** : **May 24, 2024**

---

**Shenzhen Anbotek Compliance Laboratory Limited**



**Shenzhen Anbotek Compliance Laboratory Limited**

Address: 1/F., Building D, Sogood Science and Technology Park, Sanwei Community,  
Hangcheng Street, Bao'an District, Shenzhen, Guangdong, China.  
Tel: (86)0755-26066440 Fax: (86)0755-26014772 Email: service@anbotek.com



Hotline  
400-003-0500  
www.anbotek.com.cn



# Contents

1. General Information .....	6
1.1. Client Information .....	6
1.2. Description of Device (EUT) .....	6
1.3. Auxiliary Equipment Used During Test .....	8
1.4. Operation channel list .....	8
1.5. Description of Test Modes .....	9
1.6. Measurement Uncertainty .....	10
1.7. Test Summary .....	10
1.8. Description of Test Facility .....	11
1.9. Disclaimer .....	11
1.10. Test Equipment List .....	12
2. Conducted Emission at AC power line .....	14
2.1. EUT Operation .....	14
2.2. Test Setup .....	14
2.3. Test Data .....	15
3. Duty Cycle .....	23
3.1. EUT Operation .....	23
3.2. Test Setup .....	23
3.3. Test Data .....	23
4. Maximum conducted output power .....	24
4.1. EUT Operation .....	24
4.2. Test Setup .....	25
4.3. Test Data .....	25
5. Power spectral density .....	26
5.1. EUT Operation .....	26
5.2. Test Setup .....	27
5.3. Test Data .....	27
6. Emission bandwidth and occupied bandwidth .....	28
6.1. EUT Operation .....	29
6.2. Test Setup .....	30
6.3. Test Data .....	30
7. Channel Move Time, Channel Closing Transmission Time .....	31
7.1. EUT Operation .....	32
7.2. Test Setup .....	32
7.3. Test Data .....	32
8. DFS Detection Thresholds .....	33
8.1. EUT Operation .....	33
8.2. Test Setup .....	34
8.3. Test Data .....	34
9. Band edge emissions (Radiated) .....	35
9.1. EUT Operation .....	37

**Shenzhen Anbotek Compliance Laboratory Limited**

Address: 1/F., Building D, Sogood Science and Technology Park, Sanwei Community, Hangcheng Street, Bao'an District, Shenzhen, Guangdong, China.  
Tel: (86)0755-26066440 Fax: (86)0755-26014772 Email: service@anbotek.com



Hotline  
400-003-0500  
www.anbotek.com.cn



9.2. Test Setup .....	38
9.3. Test Data .....	39
10. Band edge emissions (Conducted) .....	49
10.1. EUT Operation .....	49
10.2. Test Setup .....	49
10.3. Test Data .....	49
11. Undesirable emission limits (below 1GHz) .....	50
11.1. EUT Operation .....	52
11.2. Test Setup .....	53
11.3. Test Data .....	54
12. Undesirable emission limits (above 1GHz) .....	62
12.1. EUT Operation .....	64
12.2. Test Setup .....	65
12.3. Test Data .....	66
APPENDIX I -- TEST SETUP PHOTOGRAPH .....	70
APPENDIX II -- EXTERNAL PHOTOGRAPH .....	70
APPENDIX III -- INTERNAL PHOTOGRAPH .....	70





Report No.: 18220WC40089602

FCC ID: 2A96L-SRP2304A

Page 4 of 70

# TEST REPORT

Applicant : SprintRay Inc  
Manufacturer : Zhejiang Xunshi Technology Co., Ltd  
Product Name : Midas  
Test Model No. : SRP2304A  
Reference Model No. : N/A

Trade Mark :



Rating(s) : Input: 100-240VAC, 140W, 50/60Hz

**47 CFR Part 15E**  
**ANSI C63.10-2020**  
**KDB 789033 D02 General UNII Test Procedures New Rules v02r01**  
**Test Standard(s) : KDB 905462 D02 UNII DFS Compliance Procedures New Rules v02**  
**KDB 905462 D03 UNII Clients Without Radar Detection New Rules v01r02**  
**KDB 662911 D01 Multiple Transmitter Output v02r01**

The device described above is tested by Shenzhen Anbotek Compliance Laboratory Limited to determine the maximum emission levels emanating from the device and the severe levels of the device can endure and its performance criterion. The measurement results are contained in this test report and Shenzhen Anbotek Compliance Laboratory Limited is assumed full of responsibility for the accuracy and completeness of these measurements. Also, this report shows that the EUT (Equipment Under Test) is technically compliant with above listed standard(s) requirements. This report applies to above tested sample only and shall not be reproduced in part without written approval of Shenzhen Anbotek Compliance Laboratory Limited.

Date of Receipt:

May 08, 2024

Date of Test:

May 08, 2024 to May 17, 2024

Prepared By:

A handwritten signature in black ink that reads "Ella Liang".

(Ella Liang)

Approved &amp; Authorized Signer:

A handwritten signature in black ink that reads "Edward Pan".

(Edward Pan)

**Shenzhen Anbotek Compliance Laboratory Limited**

Address: 1/F., Building D, Sogood Science and Technology Park, Sanwei Community, Hangcheng Street, Bao'an District, Shenzhen, Guangdong, China.  
Tel: (86)0755-26066440 Fax: (86)0755-26014772 Email: service@anbotek.com



Hotline

400-003-0500

www.anbotek.com.cn

安博  
翰測

**Revision History**

Report Version	Description	Issued Date
R00	Original Issue.	May 24, 2024

**Shenzhen Anbotek Compliance Laboratory Limited**

Address: 1/F., Building D, Sogood Science and Technology Park, Sanwei Community, Hangcheng Street, Bao'an District, Shenzhen, Guangdong, China.  
Tel: (86)0755-26066440 Fax: (86)0755-26014772 Email: service@anbotek.com



Hotline  
400-003-0500  
www.anbotek.com.cn



## 1. General Information

### 1.1. Client Information

Applicant	:	SprintRay Inc
Address	:	2710 Media Center Dr, Suite 100A, Los Angeles, CA 90065-1700, USA
Manufacturer	:	Zhejiang Xunshi Technology Co., Ltd
Address	:	4 / F, building 2, Qihang building, science and Technology Park, 586 Xihuan Road, Kebei Economic Development Zone, Keqiao District, Shaoxing City, China
Factory	:	Zhejiang Xunshi Technology Co., Ltd
Address	:	4 / F, building 2, Qihang building, science and Technology Park, 586 Xihuan Road, Kebei Economic Development Zone, Keqiao District, Shaoxing City, China

### 1.2. Description of Device (EUT)

Product Name	:	Midas
Test Model No.	:	SRP2304A
Reference Model No.	:	N/A
Trade Mark	:	
Test Power Supply	:	AC 120V/60Hz
Test Sample No.	:	1-2-1(Normal Sample), 1-2-2(Engineering Sample)
Adapter	:	N/A
<b>RF Specification</b>		
Operation Frequency	:	<p>802.11a/n(HT20)/ac(VHT20)/ax(HEW20):            U-NII Band 1: 5180MHz to 5240MHz;            U-NII Band 2A: 5260MHz to 5320MHz;            U-NII Band 2C: 5500MHz to 5700MHz;            U-NII Band 3: 5745MHz to 5825MHz;</p> <p>802.11n(HT40)/ac(VHT40)/ax(HEW40):            U-NII Band 1: 5190MHz to 5230MHz;            U-NII Band 2A: 5270MHz to 5310MHz;            U-NII Band 2C: 5510MHz to 5670MHz;            U-NII Band 3: 5755MHz to 5795MHz;</p> <p>802.11ac(VHT80)/ax(HEW80):            U-NII Band 1: 5210MHz;            U-NII Band 2A: 5290MHz;            U-NII Band 2C: 5530MHz to 5610MHz;            U-NII Band 3: 5775MHz</p>

#### Shenzhen Anbotek Compliance Laboratory Limited

Address: 1/F., Building D, Sogood Science and Technology Park, Sanwei Community, Hangcheng Street, Bao'an District, Shenzhen, Guangdong, China.  
 Tel: (86)0755-26066440 Fax: (86)0755-26014772 Email: service@anbotek.com



Hotline  
 400-003-0500  
 www.anbotek.com.cn







### 1.3. Auxiliary Equipment Used During Test

Title	Manufacturer	Model No.	Serial No.
ROG Rapture Quad-band Gaming Router	ASUSTeK Computer Inc	GT-AXE16000 (FCC ID: MSQ-RTAX5D00 IC: 3568A-RTAX5D00)	RAIG5D2020695NL

### 1.4. Operation channel list

Operation Band: U-NII Band 1

Bandwidth:	20MHz	Bandwidth:	40MHz	Bandwidth:	80MHz
Channel	Frequency (MHz)	Channel	Frequency (MHz)	Channel	Frequency (MHz)
36	5180	38	5190	42	5210
40	5200	46	5230	/	/
44	5220	/	/	/	/
48	5240	/	/	/	/

Operation Band: U-NII Band 2A

Bandwidth:	20MHz	Bandwidth:	40MHz	Bandwidth:	80MHz
Channel	Frequency (MHz)	Channel	Frequency (MHz)	Channel	Frequency (MHz)
52	5260	54	5270	58	5290
56	5280	62	5310	/	/
60	5300	/	/	/	/
64	5320	/	/	/	/

Operation Band: U-NII Band 2C

Bandwidth:	20MHz	Bandwidth:	40MHz	Bandwidth:	80MHz
Channel	Frequency (MHz)	Channel	Frequency (MHz)	Channel	Frequency (MHz)
100	5500	102	5510	106	5530
104	5520	110	5550	122	5610
108	5540	118	5590	/	/
112	5560	126	5630	/	/
116	5580	134	5670	/	/
120	5600	/	/	/	/
124	5620	/	/	/	/

#### Shenzhen Anbotek Compliance Laboratory Limited

Address: 1/F., Building D, Sogood Science and Technology Park, Sanwei Community, Hangcheng Street, Bao'an District, Shenzhen, Guangdong, China.  
Tel: (86)0755-26066440 Fax: (86)0755-26014772 Email: service@anbotek.com



Hotline  
400-003-0500  
www.anbotek.com.cn





128	5640	/	/	/	/
132	5660	/	/	/	/
136	5680	/	/	/	/
140	5700	/	/	/	/

Operation Band: U-NII Band 3

Bandwidth:	20MHz	Bandwidth:	40MHz	Bandwidth:	80MHz
Channel	Frequency (MHz)	Channel	Frequency (MHz)	Channel	Frequency (MHz)
149	5745	151	5755	155	5775
153	5765	159	5795	/	/
157	5785	/	/	/	/
161	5805	/	/	/	/
165	5825	/	/	/	/

### 1.5. Description of Test Modes

Pretest Modes	Descriptions
TM1	Keep the EUT connect to AC power line and works in continuously transmitting mode with 802.11a modulation type. All data rates has been tested and found the data rate @ 6Mbps is the worst case. Only the data of worst case is recorded in the report.
TM2	Keep the EUT connect to AC power line and works in continuously transmitting mode with 802.11n modulation type. All bandwidth and data rates has been tested and found the data rate @ MCS0 is the worst case. Only the data of worst case is recorded in the report.
TM3	Keep the EUT connect to AC power line and works in continuously transmitting mode with 802.11ac modulation type. All bandwidth and data rates has been tested and found the data rate @ MCS0 is the worst case. Only the data of worst case is recorded in the report.
TM4	Keep the EUT connect to AC power line and works in continuously transmitting mode with 802.11ax modulation type. All bandwidth and data rates has been tested and found the data rate @ MCS0 is the worst case. Only the data of worst case is recorded in the report.
TM5	Keep the EUT works in normal operating mode and connect to companion device

Note: 80211ax mode only support full resource unit size.



## 1.6. Measurement Uncertainty

Parameter	Uncertainty
Conducted emissions (AMN 150kHz~30MHz)	3.4dB
Conducted Output Power	0.76dB
Power Spectral Density	0.76dB
Occupied Bandwidth	925Hz
Radiated spurious emissions (above 1GHz)	1G-6GHz: 4.78dB; 6G-18GHz: 4.88dB 18G-40GHz: 5.68dB
Radiated emissions (Below 30MHz)	3.53dB
Radiated spurious emissions (30MHz~1GHz)	Horizontal: 3.92dB; Vertical: 4.52dB
The measurement uncertainty and decision risk evaluated according to AB/WI-RF-F-032. This uncertainty represents an expanded uncertainty expressed at approximately the 95% confidence level using a coverage factor of k=2.	

## 1.7. Test Summary

Test Items	Test Modes	Status
Conducted Emission at AC power line	Mode1,2,3,4	P
Duty Cycle	Mode1,2,3,4	P
Maximum conducted output power	Mode1,2,3,4	P
Power spectral density	Mode1,2,3,4	P
Emission bandwidth and occupied bandwidth	Mode1,2,3,4	P
Channel Move Time, Channel Closing Transmission Time	Mode5	P
DFS Detection Thresholds	Mode5	P
Band edge emissions (Radiated)	Mode1,2,3,4	P
Band edge emissions (Conducted)	Mode1,2,3,4	P
Undesirable emission limits (below 1GHz)	Mode1,2,3,4	P
Undesirable emission limits (above 1GHz)	Mode1,2,3,4	P
Note: P: Pass N: N/A, not applicable		

### Shenzhen Anbotek Compliance Laboratory Limited

Address: 1/F., Building D, Sogood Science and Technology Park, Sanwei Community, Hangcheng Street, Bao'an District, Shenzhen, Guangdong, China.  
 Tel: (86)0755-26066440 Fax: (86)0755-26014772 Email: service@anbotek.com



Hotline  
 400-003-0500  
[www.anbotek.com.cn](http://www.anbotek.com.cn)



## 1.8. Description of Test Facility

The test facility is recognized, certified, or accredited by the following organizations:

### FCC-Registration No.:434132

Shenzhen Anbotek Compliance Laboratory Limited, EMC Laboratory has been registered and fully described in a report filed with the (FCC) Federal Communications Commission. The acceptance letter from the FCC is maintained in our files. Registration No. 434132.

### ISED-Registration No.: 8058A

Shenzhen Anbotek Compliance Laboratory Limited, EMC Laboratory has been registered and fully described in a report filed with the (ISED) Innovation, Science and Economic Development Canada. The acceptance letter from the ISED is maintained in our files. Registration 8058A.

### Test Location

Shenzhen Anbotek Compliance Laboratory Limited.

1/F, Building D, Sogood Science and Technology Park, Sanwei community, Hangcheng Street, Bao'an District, Shenzhen, Guangdong, China.

## 1.9. Disclaimer

1. The test report is invalid if not marked with the signatures of the persons responsible for preparing and approving the test report.
2. The test report is invalid if there is any evidence and/or falsification.
3. The results documented in this report apply only to the tested sample, under the conditions and modes of operation as described herein.
4. This document may not be altered or revised in any way unless done so by Anbotek and all revisions are duly noted in the revisions section.
5. Content of the test report, in part or in full, cannot be used for publicity and/or promotional purposes without prior written approval from the laboratory.
6. The authenticity of the information provided by the customer is the responsibility of the customer and the laboratory is not responsible for its authenticity.

The laboratory is only responsible for the data released by the laboratory, except for the part provided by the applicant.

### Shenzhen Anbotek Compliance Laboratory Limited

Address:1/F.,Building D,Sogood Science and Technology Park, Sanwei Community,  
Hangcheng Street, Bao'an District, Shenzhen, Guangdong, China.  
Tel:(86)0755-26066440 Fax:(86)0755-26014772 Email:service@anbotek.com



Hotline  
400-003-0500  
www.anbotek.com.cn





**1.10. Test Equipment List**

Conducted Emission at AC power line						
Item	Equipment	Manufacturer	Model No.	Serial No.	Last Cal.	Cal.Due Date
1	L.I.S.N. Artificial Mains Network	Rohde & Schwarz	ENV216	100055	2024-01-18	2025-01-17
2	Three Phase V-type Artificial Power Network	CYBERTEK	EM5040DT	E215040D T001	2024-01-17	2025-01-16
3	Software Name EZ-EMC	Farad Technology	ANB-03A	N/A	/	/
4	EMI Test Receiver	Rohde & Schwarz	ESPI3	100926	2023-10-12	2024-10-11

**Duty Cycle**

Maximum conducted output power

Power spectral density

Emission bandwidth and occupied bandwidth

Channel Move Time, Channel Closing Transmission Time

DFS Detection Thresholds

Band edge emissions (Conducted)

Item	Equipment	Manufacturer	Model No.	Serial No.	Last Cal.	Cal.Due Date
1	Constant Temperature Humidity Chamber	ZHONGJIAN	ZJ-KHWS80B	N/A	2023-10-16	2024-10-15
2	DC Power Supply	IVYTECH	IV3605	1804D360 510	2023-10-20	2024-10-19
3	Spectrum Analyzer	Rohde & Schwarz	FSV40-N	101792	2024-05-06	2025-05-05
4	MXA Spectrum Analysis	KEYSIGHT	N9020A	MY505318 23	2024-02-22	2025-02-21
5	Oscilloscope	Tektronix	MDO3012	C020298	2023-10-12	2024-10-11
6	MXG RF Vector Signal Generator	Agilent	N5182A	MY474206 47	2024-02-04	2025-02-03

**Shenzhen Anbotek Compliance Laboratory Limited**

Address: 1/F., Building D, Sogood Science and Technology Park, Sanwei Community, Hangcheng Street, Bao'an District, Shenzhen, Guangdong, China.  
 Tel: (86)0755-26066440 Fax: (86)0755-26014772 Email: service@anbotek.com



Hotline  
400-003-0500  
www.anbotek.com.cn



Band edge emissions (Radiated) Undesirable emission limits (above 1GHz)						
Item	Equipment	Manufacturer	Model No.	Serial No.	Last Cal.	Cal.Due Date
1	EMI Test Receiver	Rohde & Schwarz	ESR26	101481	2024-01-23	2025-01-22
2	EMI Preamplifier	SKET Electronic	LNPA-0118G-45	SKET-PA-002	2024-01-17	2025-01-16
3	Double Ridged Horn Antenna	SCHWARZBECK	BBHA 9120D	02555	2022-10-16	2025-10-15
4	EMI Test Software EZ-EMC	SHURPLE	N/A	N/A	/	/
5	Horn Antenna	A-INFO	LB-180400-KF	J211060628	2023-10-12	2024-10-11
6	Spectrum Analyzer	Rohde & Schwarz	FSV40-N	101792	2024-05-06	2025-05-05
7	Amplifier	Talent Microwave	TLLA18G40 G-50-30	23022802	2024-05-07	2025-05-06

Undesirable emission limits (below 1GHz)						
Item	Equipment	Manufacturer	Model No.	Serial No.	Last Cal.	Cal.Due Date
1	EMI Test Receiver	Rohde & Schwarz	ESR26	101481	2024-01-23	2025-01-22
2	Pre-amplifier	SONOMA	310N	186860	2024-01-17	2025-01-16
3	Bilog Broadband Antenna	Schwarzbeck	VULB9163	345	2022-10-23	2025-10-22
4	Loop Antenna (9K-30M)	Schwarzbeck	FMZB1519 B	00053	2023-10-12	2024-10-11
5	EMI Test Software EZ-EMC	SHURPLE	N/A	N/A	/	/

**Shenzhen Anbotek Compliance Laboratory Limited**

Address: 1/F., Building D, Sogood Science and Technology Park, Sanwei Community, Hangcheng Street, Bao'an District, Shenzhen, Guangdong, China.  
 Tel: (86)0755-26066440 Fax: (86)0755-26014772 Email: service@anbotek.com



Hotline  
 400-003-0500  
[www.anbotek.com.cn](http://www.anbotek.com.cn)



## 2. Conducted Emission at AC power line

Test Requirement:	47 CFR Part 15.207(a)		
Test Limit:	Frequency of emission (MHz)	Conducted limit (dBμV)	
		Quasi-peak	Average
	0.15-0.5	66 to 56*	56 to 46*
	0.5-5	56	46
	5-30	60	50
*Decreases with the logarithm of the frequency.			
Test Method:	ANSI C63.10-2020 section 6.2		

### 2.1. EUT Operation

Operating Environment:	
Test mode:	<p>1: 802.11a mode: Keep the EUT connect to AC power line and works in continuously transmitting mode with 802.11a modulation type. All data rates has been tested and found the data rate @ 6Mbps is the worst case. Only the data of worst case is recorded in the report.</p> <p>2: 802.11n mode: Keep the EUT connect to AC power line and works in continuously transmitting mode with 802.11n modulation type. All bandwidth and data rates has been tested and found the data rate @ MCS0 is the worst case. Only the data of worst case is recorded in the report.</p> <p>3: 802.11ac mode: Keep the EUT connect to AC power line and works in continuously transmitting mode with 802.11ac modulation type. All bandwidth and data rates has been tested and found the data rate @ MCS0 is the worst case. Only the data of worst case is recorded in the report.</p> <p>4: 802.11ax mode: Keep the EUT connect to AC power line and works in continuously transmitting mode with 802.11ax modulation type. All bandwidth and data rates has been tested and found the data rate @ MCS0 is the worst case. Only the data of worst case is recorded in the report.</p>

### 2.2. Test Setup

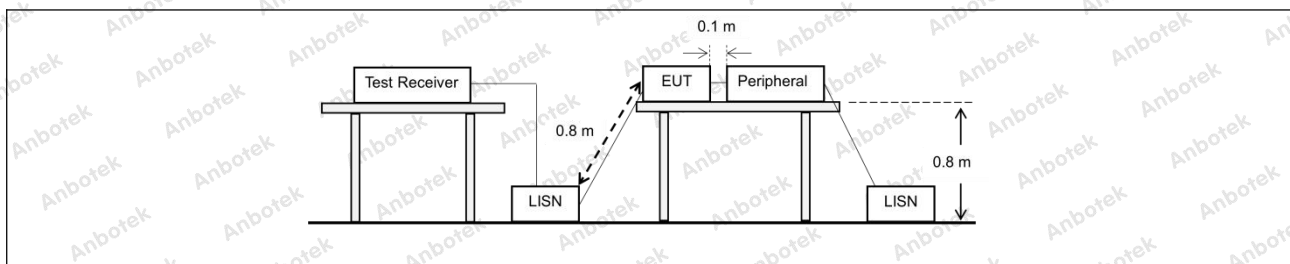



### 2.3. Test Data

Temperature:	24.7 °C	Humidity:	48.1 %	Atmospheric Pressure:	101 kPa
--------------	---------	-----------	--------	-----------------------	---------

TM4 / Line: Line / Band: 5180-5240 MHz / BW: 20 / CH: L/ MIMO

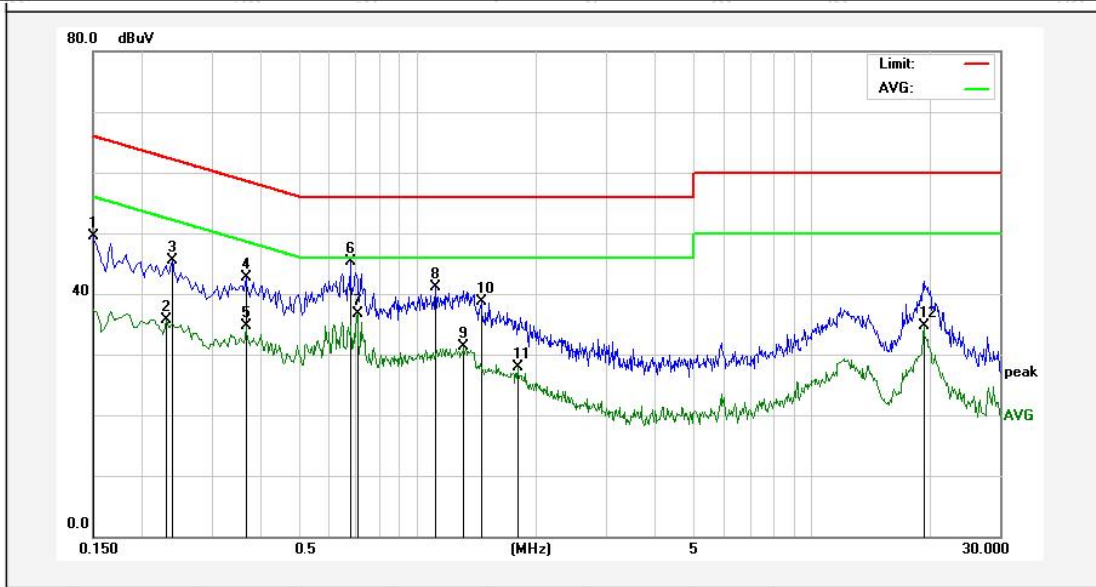

No.	Freq. (MHz)	Reading (dBuV)	Factor (dB)	Result (dBuV)	Limit (dBuV)	Over Limit (dB)	Detector	Remark
1	0.1500	31.76	17.82	49.58	65.99	-16.41	QP	
2	0.2300	17.95	17.82	35.77	52.45	-16.68	AVG	
3	0.2380	27.66	17.82	45.48	62.16	-16.68	QP	
4	0.3660	24.90	17.82	42.72	58.59	-15.87	QP	
5	0.3660	16.88	17.82	34.70	48.59	-13.89	AVG	
6	0.6780	27.42	17.87	45.29	56.00	-10.71	QP	
7	0.7060	18.90	17.87	36.77	46.00	-9.23	AVG	
8	1.1140	23.15	17.86	41.01	56.00	-14.99	QP	
9	1.3099	13.40	17.86	31.26	46.00	-14.74	AVG	
10	1.4500	20.77	17.86	38.63	56.00	-17.37	QP	
11	1.7980	9.97	17.86	27.83	46.00	-18.17	AVG	
12	19.2740	16.42	18.27	34.69	50.00	-15.31	AVG	



Temperature: 24.7 °C

Humidity: 48.1 %

Atmospheric Pressure: 101 kPa

TM4 / Line: Neutral / Band: 5180-5240 MHz / BW: 20 / CH: L / MIMO

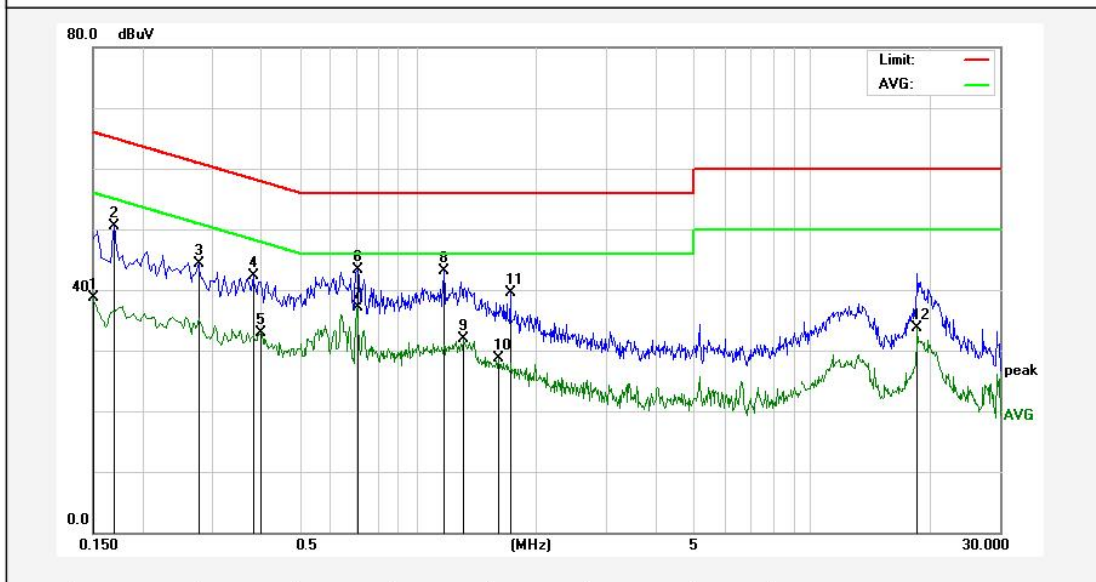

No.	Freq. (MHz)	Reading (dBuV)	Factor (dB)	Result (dBuV)	Limit (dBuV)	Over Limit (dB)	Detector	Remark
1	0.1500	20.93	17.82	38.75	55.99	-17.24	AVG	
2	0.1700	32.58	17.83	50.41	64.96	-14.55	QP	
3	0.2779	26.53	17.84	44.37	60.88	-16.51	QP	
4	0.3820	24.58	17.81	42.39	58.23	-15.84	QP	
5	0.3980	15.13	17.81	32.94	47.89	-14.95	AVG	
6	0.7060	25.35	17.87	43.22	56.00	-12.78	QP	
7	0.7060	19.29	17.87	37.16	46.00	-8.84	AVG	
8	1.1700	25.17	17.85	43.02	56.00	-12.98	QP	
9	1.3060	14.13	17.86	31.99	46.00	-14.01	AVG	
10	1.6100	10.77	17.85	28.62	46.00	-17.38	AVG	
11	1.7180	21.57	17.85	39.42	56.00	-16.58	QP	
12	18.5380	15.48	18.24	33.72	50.00	-16.28	AVG	

**Shenzhen Anbotek Compliance Laboratory Limited**

Address: 1/F., Building D, Sogood Science and Technology Park, Sanwei Community, Hangcheng Street, Bao'an District, Shenzhen, Guangdong, China.  
 Tel: (86)0755-26066440 Fax: (86)0755-26014772 Email: service@anbotek.com

Hotline 400-003-0500  
 www.anbotek.com.cn



Temperature: 24.7 °C

Humidity: 48.1 %

Atmospheric Pressure: 101 kPa

TM4 / Line: Line / Band: 5260-5320 MHz / BW: 20 / CH: L / MIMO

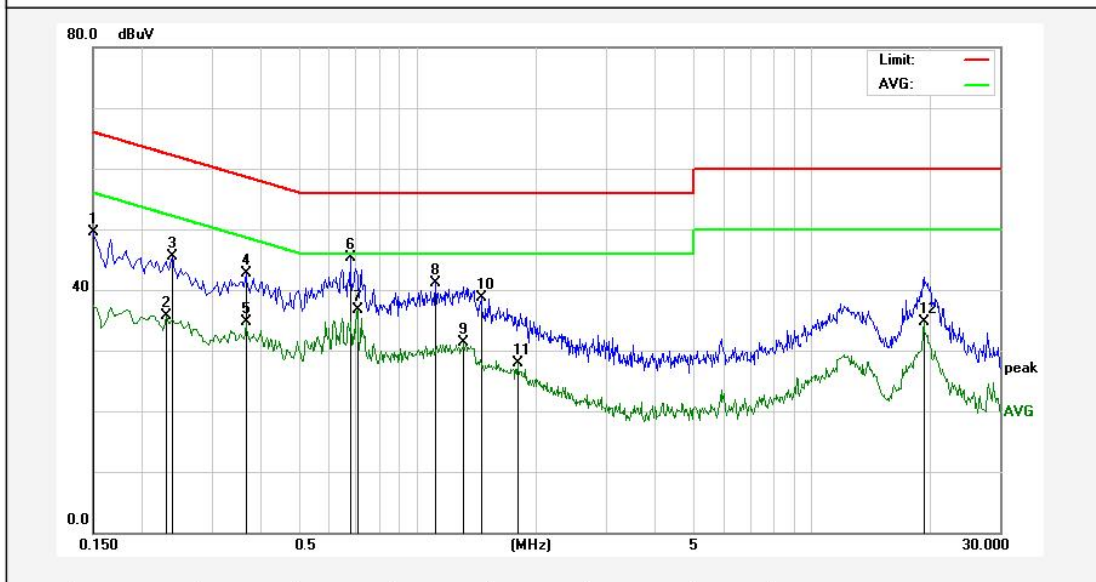

No.	Freq. (MHz)	Reading (dBuV)	Factor (dB)	Result (dBuV)	Limit (dBuV)	Over Limit (dB)	Detector	Remark
1	0.1500	31.76	17.82	49.58	65.99	-16.41	QP	
2	0.2300	17.95	17.82	35.77	52.45	-16.68	AVG	
3	0.2380	27.66	17.82	45.48	62.16	-16.68	QP	
4	0.3660	24.90	17.82	42.72	58.59	-15.87	QP	
5	0.3660	16.88	17.82	34.70	48.59	-13.89	AVG	
6	0.6780	27.42	17.87	45.29	56.00	-10.71	QP	
7	0.7060	18.90	17.87	36.77	46.00	-9.23	AVG	
8	1.1140	23.15	17.86	41.01	56.00	-14.99	QP	
9	1.3099	13.40	17.86	31.26	46.00	-14.74	AVG	
10	1.4500	20.77	17.86	38.63	56.00	-17.37	QP	
11	1.7980	9.97	17.86	27.83	46.00	-18.17	AVG	
12	19.2740	16.42	18.27	34.69	50.00	-15.31	AVG	

**Shenzhen Anbotek Compliance Laboratory Limited**

Address: 1/F., Building D, Sogood Science and Technology Park, Sanwei Community, Hangcheng Street, Bao'an District, Shenzhen, Guangdong, China.  
 Tel: (86)0755-26066440 Fax: (86)0755-26014772 Email: service@anbotek.com



Hotline  
 400-003-0500  
 www.anbotek.com.cn





Temperature:	24.7 °C	Humidity:	48.1 %	Atmospheric Pressure:	101 kPa
--------------	---------	-----------	--------	-----------------------	---------

TM4 / Line: Neutral / Band: 5260-5320 MHz / BW: 20 / CH: L / MIMO

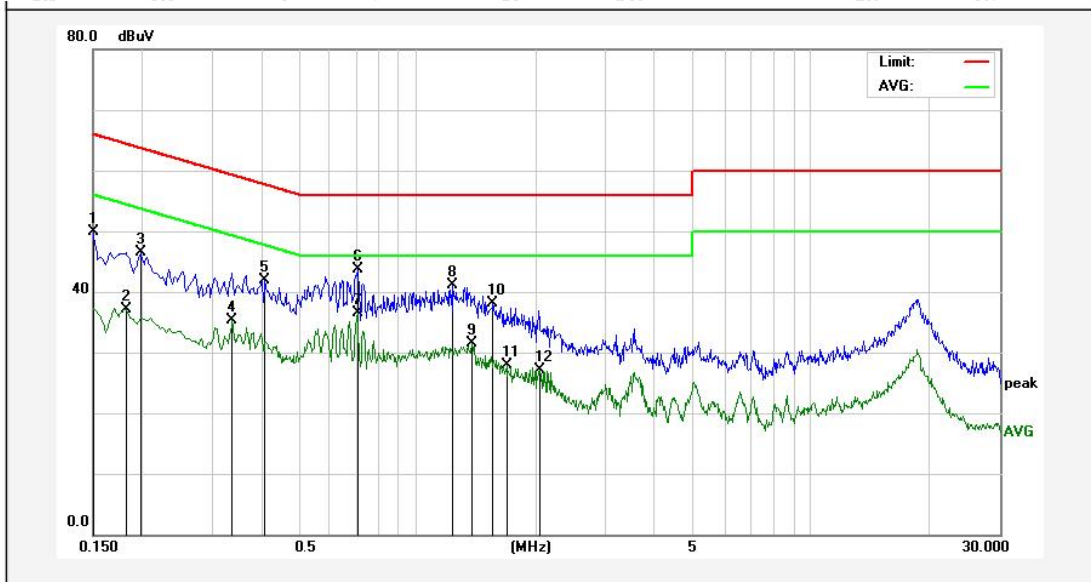

No.	Freq. (MHz)	Reading (dBuV)	Factor (dB)	Result (dBuV)	Limit (dBuV)	Over Limit (dB)	Detector	Remark
1	0.1500	32.12	17.82	49.94	65.99	-16.05	QP	
2	0.1819	19.33	17.83	37.16	54.39	-17.23	AVG	
3	0.1980	28.76	17.83	46.59	63.69	-17.10	QP	
4	0.3379	17.43	17.82	35.25	49.25	-14.00	AVG	
5	0.4100	24.07	17.81	41.88	57.65	-15.77	QP	
6	0.7060	25.89	17.87	43.76	56.00	-12.24	QP	
7	0.7060	18.56	17.87	36.43	46.00	-9.57	AVG	
8	1.2340	23.23	17.84	41.07	56.00	-14.93	QP	
9	1.3779	13.73	17.84	31.57	46.00	-14.43	AVG	
10	1.5580	20.17	17.84	38.01	56.00	-17.99	QP	
11	1.6820	9.99	17.84	27.83	46.00	-18.17	AVG	
12	2.0340	9.21	17.83	27.04	46.00	-18.96	AVG	

**Shenzhen Anbotek Compliance Laboratory Limited**

Address: 1/F., Building D, Sogood Science and Technology Park, Sanwei Community, Hangcheng Street, Bao'an District, Shenzhen, Guangdong, China.  
 Tel: (86)0755-26066440 Fax: (86)0755-26014772 Email: service@anbotek.com

Hotline 400-003-0500  
 www.anbotek.com.cn



Temperature:	24.7 °C	Humidity:	48.1 %	Atmospheric Pressure:	101 kPa
--------------	---------	-----------	--------	-----------------------	---------

TM4 / Line: Line / Band: 5500-5700 MHz / BW: 20 / CH: L/ MIMO

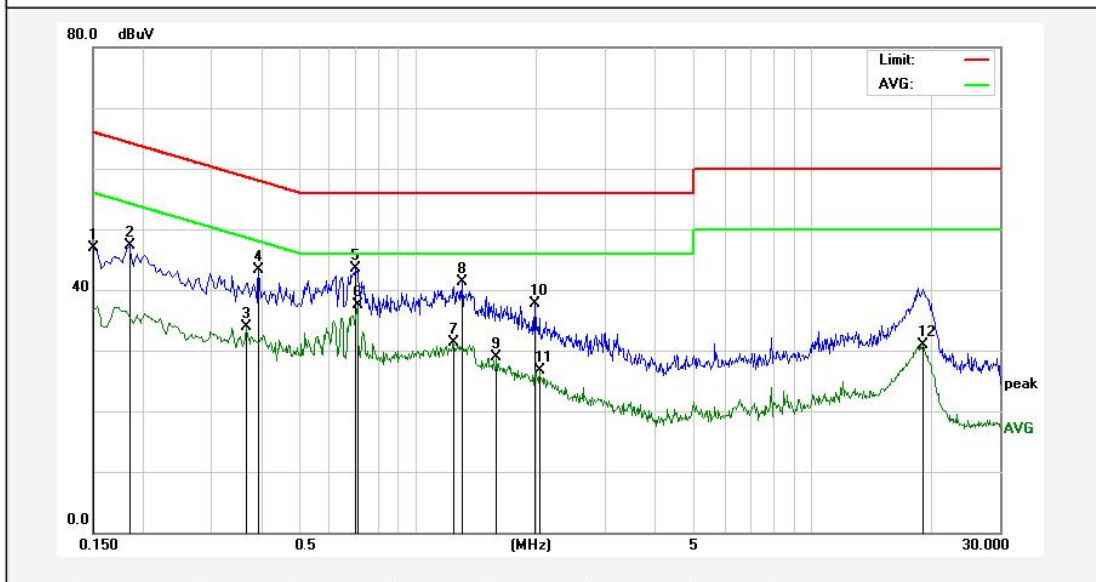

No.	Freq. (MHz)	Reading (dBuV)	Factor (dB)	Result (dBuV)	Limit (dBuV)	Over Limit (dB)	Detector	Remark
1	0.1500	29.14	17.82	46.96	65.99	-19.03	QP	
2	0.1860	29.44	17.83	47.27	64.21	-16.94	QP	
3	0.3660	16.08	17.82	33.90	48.59	-14.69	AVG	
4	0.3940	25.52	17.81	43.33	57.98	-14.65	QP	
5	0.6980	25.58	17.87	43.45	56.00	-12.55	QP	
6	0.7060	19.61	17.87	37.48	46.00	-8.52	AVG	
7	1.2340	13.39	17.84	31.23	46.00	-14.77	AVG	
8	1.2980	23.55	17.84	41.39	56.00	-14.61	QP	
9	1.5859	10.98	17.84	28.82	46.00	-17.18	AVG	
10	1.9860	19.83	17.83	37.66	56.00	-18.34	QP	
11	2.0340	8.82	17.83	26.65	46.00	-19.35	AVG	
12	19.1740	12.71	18.28	30.99	50.00	-19.01	AVG	

**Shenzhen Anbotek Compliance Laboratory Limited**

Address: 1/F., Building D, Sogood Science and Technology Park, Sanwei Community, Hangcheng Street, Bao'an District, Shenzhen, Guangdong, China.  
 Tel: (86)0755-26066440 Fax: (86)0755-26014772 Email: service@anbotek.com

Hotline 400-003-0500  
 www.anbotek.com.cn



Temperature:	24.7 °C	Humidity:	48.1 %	Atmospheric Pressure:	101 kPa
--------------	---------	-----------	--------	-----------------------	---------

TM4 / Line: Neutral / Band: 5500-5700 MHz / BW: 20 / CH: L/ MIMO

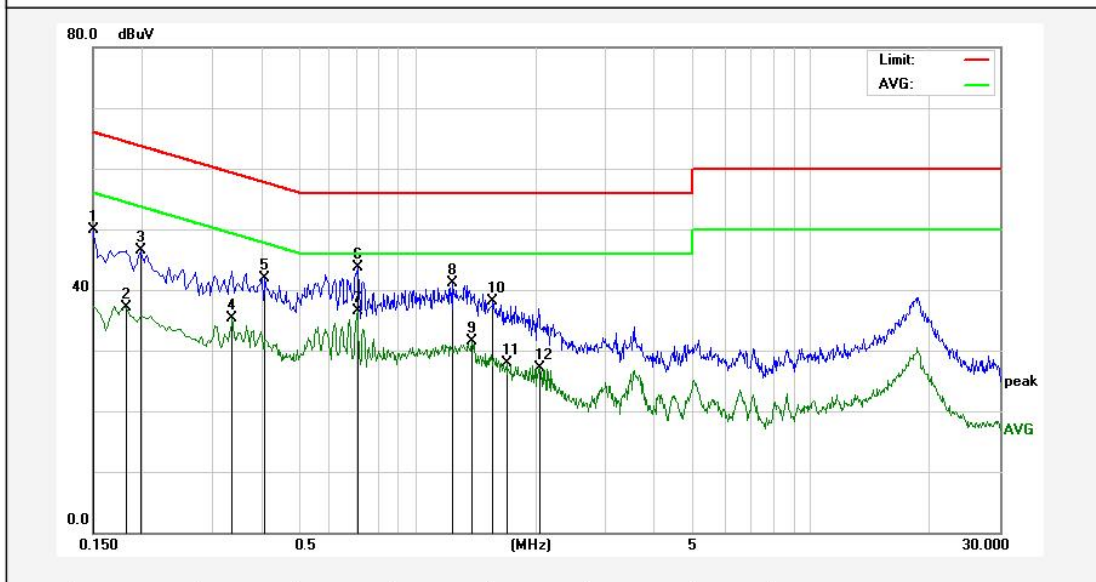

No.	Freq. (MHz)	Reading (dBuV)	Factor (dB)	Result (dBuV)	Limit (dBuV)	Over Limit (dB)	Detector	Remark
1	0.1500	32.12	17.82	49.94	65.99	-16.05	QP	
2	0.1819	19.33	17.83	37.16	54.39	-17.23	AVG	
3	0.1980	28.76	17.83	46.59	63.69	-17.10	QP	
4	0.3379	17.43	17.82	35.25	49.25	-14.00	AVG	
5	0.4100	24.07	17.81	41.88	57.65	-15.77	QP	
6	0.7060	25.89	17.87	43.76	56.00	-12.24	QP	
7	0.7060	18.56	17.87	36.43	46.00	-9.57	AVG	
8	1.2340	23.23	17.84	41.07	56.00	-14.93	QP	
9	1.3779	13.73	17.84	31.57	46.00	-14.43	AVG	
10	1.5580	20.17	17.84	38.01	56.00	-17.99	QP	
11	1.6820	9.99	17.84	27.83	46.00	-18.17	AVG	
12	2.0340	9.21	17.83	27.04	46.00	-18.96	AVG	

**Shenzhen Anbotek Compliance Laboratory Limited**

Address: 1/F., Building D, Sogood Science and Technology Park, Sanwei Community, Hangcheng Street, Bao'an District, Shenzhen, Guangdong, China.  
 Tel: (86)0755-26066440 Fax: (86)0755-26014772 Email: service@anbotek.com

Hotline 400-003-0500  
 www.anbotek.com.cn





Temperature: 24.7 °C

Humidity: 48.1 %

Atmospheric Pressure: 101 kPa

TM4 / Line: Line / Band: 5745-5825 MHz / BW: 20 / CH: L/ MIMO

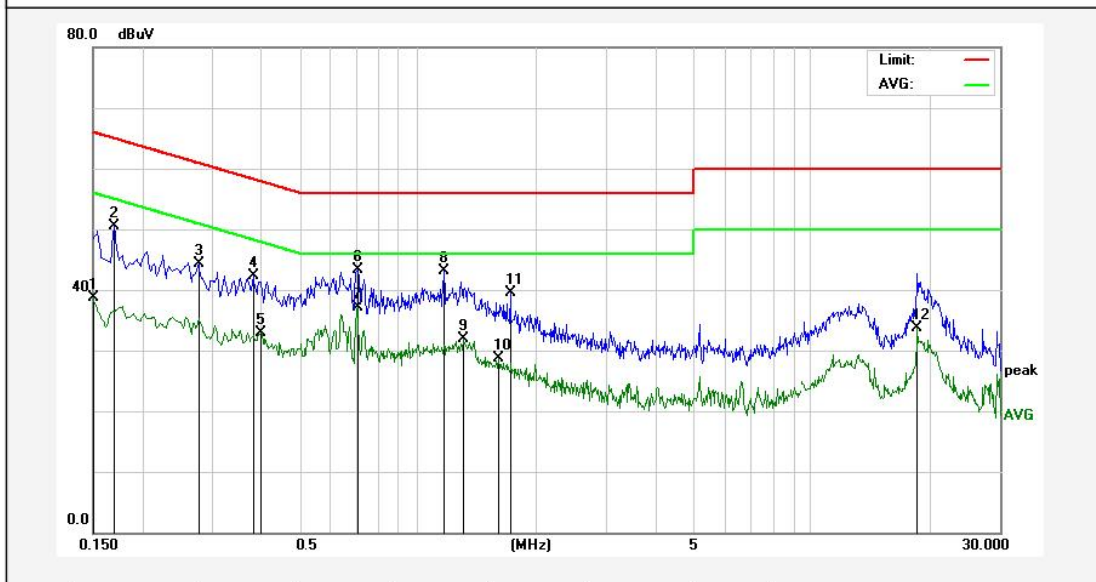

No.	Freq. (MHz)	Reading (dBuV)	Factor (dB)	Result (dBuV)	Limit (dBuV)	Over Limit (dB)	Detector	Remark
1	0.1500	20.93	17.82	38.75	55.99	-17.24	AVG	
2	0.1700	32.58	17.83	50.41	64.96	-14.55	QP	
3	0.2779	26.53	17.84	44.37	60.88	-16.51	QP	
4	0.3820	24.58	17.81	42.39	58.23	-15.84	QP	
5	0.3980	15.13	17.81	32.94	47.89	-14.95	AVG	
6	0.7060	25.35	17.87	43.22	56.00	-12.78	QP	
7	0.7060	19.29	17.87	37.16	46.00	-8.84	AVG	
8	1.1700	25.17	17.85	43.02	56.00	-12.98	QP	
9	1.3060	14.13	17.86	31.99	46.00	-14.01	AVG	
10	1.6100	10.77	17.85	28.62	46.00	-17.38	AVG	
11	1.7180	21.57	17.85	39.42	56.00	-16.58	QP	
12	18.5380	15.48	18.24	33.72	50.00	-16.28	AVG	

**Shenzhen Anbotek Compliance Laboratory Limited**

Address: 1/F., Building D, Sogood Science and Technology Park, Sanwei Community, Hangcheng Street, Bao'an District, Shenzhen, Guangdong, China.  
 Tel: (86)0755-26066440 Fax: (86)0755-26014772 Email: service@anbotek.com

Hotline 400-003-0500  
 www.anbotek.com.cn



Temperature:	24.7 °C	Humidity:	48.1 %	Atmospheric Pressure:	101 kPa
--------------	---------	-----------	--------	-----------------------	---------

TM4 / Line: Neutral / Band: 5745-5825 MHz / BW: 20 / CH: L/ MIMO

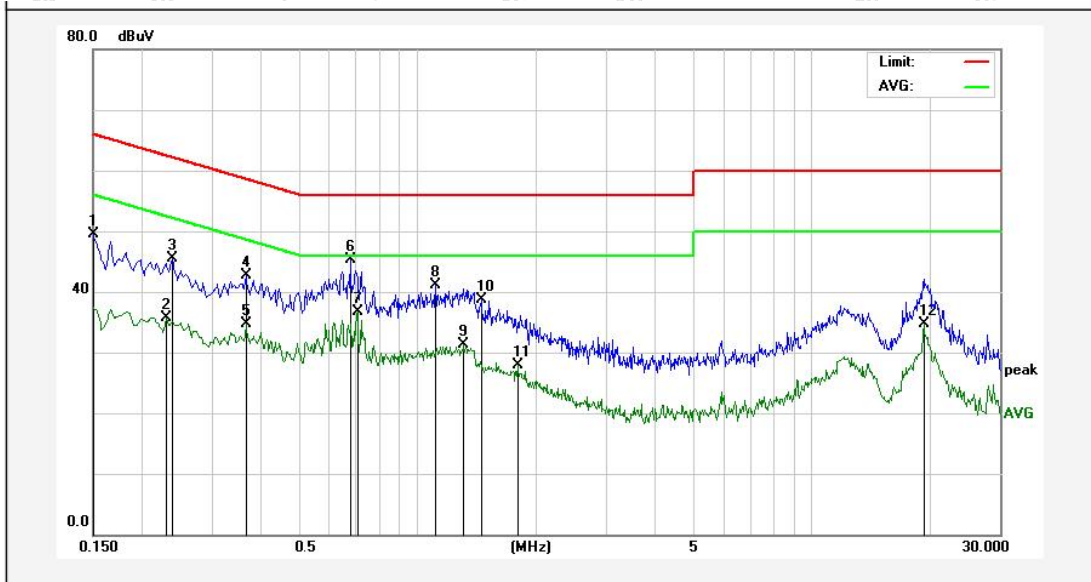

No.	Freq. (MHz)	Reading (dBuV)	Factor (dB)	Result (dBuV)	Limit (dBuV)	Over Limit (dB)	Detector	Remark
1	0.1500	31.76	17.82	49.58	65.99	-16.41	QP	
2	0.2300	17.95	17.82	35.77	52.45	-16.68	AVG	
3	0.2380	27.66	17.82	45.48	62.16	-16.68	QP	
4	0.3660	24.90	17.82	42.72	58.59	-15.87	QP	
5	0.3660	16.88	17.82	34.70	48.59	-13.89	AVG	
6	0.6780	27.42	17.87	45.29	56.00	-10.71	QP	
7	0.7060	18.90	17.87	36.77	46.00	-9.23	AVG	
8	1.1140	23.15	17.86	41.01	56.00	-14.99	QP	
9	1.3099	13.40	17.86	31.26	46.00	-14.74	AVG	
10	1.4500	20.77	17.86	38.63	56.00	-17.37	QP	
11	1.7980	9.97	17.86	27.83	46.00	-18.17	AVG	
12	19.2740	16.42	18.27	34.69	50.00	-15.31	AVG	

Note: Only record the worst data (802.11ax(HEW20) MIMO) in the report.

### Shenzhen Anbotek Compliance Laboratory Limited

Address: 1/F., Building D, Sogood Science and Technology Park, Sanwei Community, Hangcheng Street, Bao'an District, Shenzhen, Guangdong, China.  
 Tel: (86)0755-26066440 Fax: (86)0755-26014772 Email: service@anbotek.com

Hotline  
 400-003-0500  
 www.anbotek.com.cn



### 3. Duty Cycle

Test Requirement:	All measurements are to be performed with the EUT transmitting at 100% duty cycle at its maximum power control level; however, if 100% duty cycle cannot be achieved, measurements of duty cycle, x, and maximum-power transmission duration, T, are required for each tested mode of operation.
Test Limit:	No limits, only for report use.
Test Method:	ANSI C63.10-2020 section 12.2 (b)
Procedure:	<ul style="list-style-type: none"> <li>i) Set the center frequency of the instrument to the center frequency of the transmission.</li> <li>ii) Set RBW <math>\geq</math> EBW if possible; otherwise, set RBW to the largest available value.</li> <li>iii) Set VBW <math>\geq</math> RBW.</li> <li>iv) Set detector = peak.</li> <li>v) The zero-span measurement method shall not be used unless both RBW and VBW are <math>&gt; 50/T</math>, where T is defined in item a1) of 12.2, and the number of sweep points across duration T exceeds 100.</li> </ul>

#### 3.1. EUT Operation

Operating Environment:	
Test mode:	<ul style="list-style-type: none"> <li>1: 802.11a mode: Keep the EUT connect to AC power line and works in continuously transmitting mode with 802.11a modulation type. All data rates has been tested and found the data rate @ 6Mbps is the worst case. Only the data of worst case is recorded in the report.</li> <li>2: 802.11n mode: Keep the EUT connect to AC power line and works in continuously transmitting mode with 802.11n modulation type. All bandwidth and data rates has been tested and found the data rate @ MCS0 is the worst case. Only the data of worst case is recorded in the report.</li> <li>3: 802.11ac mode: Keep the EUT connect to AC power line and works in continuously transmitting mode with 802.11ac modulation type. All bandwidth and data rates has been tested and found the data rate @ MCS0 is the worst case. Only the data of worst case is recorded in the report.</li> <li>4: 802.11ax mode: Keep the EUT connect to AC power line and works in continuously transmitting mode with 802.11ax modulation type. All bandwidth and data rates has been tested and found the data rate @ MCS0 is the worst case. Only the data of worst case is recorded in the report.</li> </ul>

#### 3.2. Test Setup

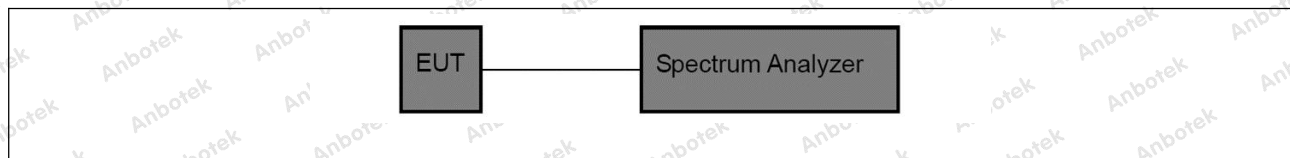

#### 3.3. Test Data

Temperature:	24.6 °C	Humidity:	46 %	Atmospheric Pressure:	101 kPa
--------------	---------	-----------	------	-----------------------	---------

Please Refer to Appendix for Details.





## 4. Maximum conducted output power

Test Requirement:	47 CFR Part 15.407(a)(1)(iv) 47 CFR Part 15.407(a)(2) 47 CFR Part 15.407(a)(3)(i)
Test Limit:	<p>For client devices in the 5.15-5.25 GHz band, the maximum conducted output power over the frequency band of operation shall not exceed 250 mW provided the maximum antenna gain does not exceed 6 dBi. If transmitting antennas of directional gain greater than 6 dBi are used, the maximum conducted output power shall be reduced by the amount in dB that the directional gain of the antenna exceeds 6 dBi.</p> <p>For the 5.25-5.35 GHz and 5.47-5.725 GHz bands, the maximum conducted output power over the frequency bands of operation shall not exceed the lesser of 250 mW or 11 dBm + 10 log B, where B is the 26 dB emission bandwidth in megahertz. If transmitting antennas of directional gain greater than 6 dBi are used, the maximum conducted output power shall be reduced by the amount in dB that the directional gain of the antenna exceeds 6 dBi.</p> <p>For the band 5.725-5.850 GHz, the maximum conducted output power over the frequency band of operation shall not exceed 1 W. If transmitting antennas of directional gain greater than 6 dBi are used, the maximum conducted output power shall be reduced by the amount in dB that the directional gain of the antenna exceeds 6 dBi. However, fixed point-to-point U-NII devices operating in this band may employ transmitting antennas with directional gain greater than 6 dBi without any corresponding reduction in transmitter conducted power. Fixed, point-to-point operations exclude the use of point-to-multipoint systems, omnidirectional applications, and multiple collocated transmitters transmitting the same information. The operator of the U-NII device, or if the equipment is professionally installed, the installer, is responsible for ensuring that systems employing high gain directional antennas are used exclusively for fixed, point-to-point operations.</p>
Test Method:	ANSI C63.10-2013, section 12.4
Procedure:	Refer to ANSI C63.10-2020 section 12.4

### 4.1. EUT Operation

Operating Environment:	
Test mode:	<p>1: 802.11a mode: Keep the EUT connect to AC power line and works in continuously transmitting mode with 802.11a modulation type. All data rates has been tested and found the data rate @ 6Mbps is the worst case. Only the data of worst case is recorded in the report.</p> <p>2: 802.11n mode: Keep the EUT connect to AC power line and works in continuously transmitting mode with 802.11n modulation type. All bandwidth and data rates has been tested and found the data rate @ MCS0 is the worst case. Only the data of worst case is recorded in the report.</p> <p>3: 802.11ac mode: Keep the EUT connect to AC power line and works in continuously transmitting mode with 802.11ac modulation type. All bandwidth and data rates has been tested and found the data rate @ MCS0 is the worst case. Only</p>



the data of worst case is recorded in the report.  
4: 802.11ax mode: Keep the EUT connect to AC power line and works in continuously transmitting mode with 802.11ax modulation type. All bandwidth and data rates has been tested and found the data rate @ MCS0 is the worst case. Only the data of worst case is recorded in the report.

## 4.2. Test Setup

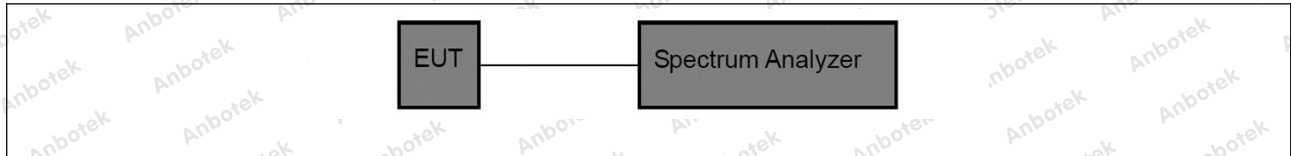

## 4.3. Test Data

Temperature:	24.6 °C	Humidity:	46 %	Atmospheric Pressure:	101 kPa
--------------	---------	-----------	------	-----------------------	---------

Please Refer to Appendix for Details.





## 5. Power spectral density

Test Requirement:	47 CFR Part 15.407(a)(1)(iv) 47 CFR Part 15.407(a)(2) 47 CFR Part 15.407(a)(3)(i)
Test Limit:	<p>For client devices in the 5.15-5.25 GHz band, the maximum power spectral density shall not exceed 11 dBm in any 1 megahertz band. If transmitting antennas of directional gain greater than 6 dBi are used, the maximum power spectral density shall be reduced by the amount in dB that the directional gain of the antenna exceeds 6 dBi.</p> <p>For the 5.25-5.35 GHz and 5.47-5.725 GHz bands, the maximum power spectral density shall not exceed 11 dBm in any 1 megahertz band. If transmitting antennas of directional gain greater than 6 dBi are used, the maximum power spectral density shall be reduced by the amount in dB that the directional gain of the antenna exceeds 6 dBi.</p> <p>For the band 5.725-5.850 GHz, the maximum power spectral density shall not exceed 30 dBm in any 500-kHz band. If transmitting antennas of directional gain greater than 6 dBi are used, the maximum power spectral density shall be reduced by the amount in dB that the directional gain of the antenna exceeds 6 dBi. However, fixed point-to-point U-NII devices operating in this band may employ transmitting antennas with directional gain greater than 6 dBi without any corresponding reduction in transmitter conducted power.</p> <p>Fixed, point-to-point operations exclude the use of point-to-multipoint systems, omnidirectional applications, and multiple collocated transmitters transmitting the same information. The operator of the U-NII device, or if the equipment is professionally installed, the installer, is responsible for ensuring that systems employing high gain directional antennas are used exclusively for fixed, point-to-point operations.</p>
Test Method:	ANSI C63.10-2020, section 12.6
Procedure:	Refer to ANSI C63.10-2020, section 12.6

### 5.1. EUT Operation

Operating Environment:	
Test mode:	<p>1: 802.11a mode: Keep the EUT connect to AC power line and works in continuously transmitting mode with 802.11a modulation type. All data rates has been tested and found the data rate @ 6Mbps is the worst case. Only the data of worst case is recorded in the report.</p> <p>2: 802.11n mode: Keep the EUT connect to AC power line and works in continuously transmitting mode with 802.11n modulation type. All bandwidth and data rates has been tested and found the data rate @ MCS0 is the worst case. Only the data of worst case is recorded in the report.</p> <p>3: 802.11ac mode: Keep the EUT connect to AC power line and works in continuously transmitting mode with 802.11ac modulation type. All bandwidth and data rates has been tested and found the data rate @ MCS0 is the worst case. Only the data of worst case is recorded in the report.</p> <p>4: 802.11ax mode: Keep the EUT connect to AC power line and works in continuously transmitting mode with 802.11ax modulation type. All bandwidth and</p>





data rates has been tested and found the data rate @ MCS0 is the worst case. Only the data of worst case is recorded in the report.

## 5.2. Test Setup

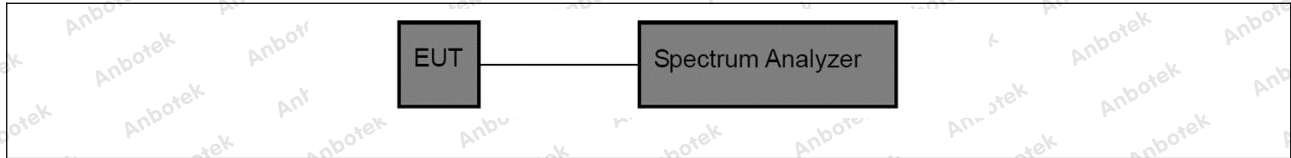

## 5.3. Test Data

Temperature:	24.6 °C	Humidity:	46 %	Atmospheric Pressure:	101 kPa
--------------	---------	-----------	------	-----------------------	---------

Please Refer to Appendix for Details.



## 6. Emission bandwidth and occupied bandwidth

Test Requirement:	U-NII 1, U-NII 2A, U-NII 2C: No limits, only for report use. U-NII 3, U-NII 4: 47 CFR Part 15.407(e)
Test Limit:	U-NII 1, U-NII 2A, U-NII 2C: No limits, only for report use. U-NII 3, U-NII 4: Within the 5.725-5.850 GHz and 5.850-5.895 GHz bands, the minimum 6 dB bandwidth of U-NII devices shall be at least 500 kHz.
Test Method:	ANSI C63.10-2020, section 6.9 & 12.5 KDB 789033 D02, Clause C.2
Procedure:	<p>Emission bandwidth:</p> <ol style="list-style-type: none"> <li>Set RBW = approximately 1% of the emission bandwidth.</li> <li>Set the VBW &gt; RBW.</li> <li>Detector = peak.</li> <li>Trace mode = max hold.</li> <li>Measure the maximum width of the emission that is 26 dB down from the peak of the emission. Compare this with the RBW setting of the instrument. Readjust RBW and repeat measurement as needed until the RBW/EBW ratio is approximately 1%.</li> </ol> <p>Occupied bandwidth:</p> <ol style="list-style-type: none"> <li>The instrument center frequency is set to the nominal EUT channel center frequency. The frequency span for the spectrum analyzer shall be between 1.5 times and 5.0 times the OBW.</li> <li>The nominal IF filter bandwidth (3 dB RBW) shall be in the range of 1% to 5% of the OBW, and VBW shall be approximately three times the RBW, unless otherwise specified by the applicable requirement.</li> <li>Set the reference level of the instrument as required, keeping the signal from exceeding the maximum input mixer level for linear operation. In general, the peak of the spectral envelope shall be more than <math>[10 \log (OBW/RBW)]</math> below the reference level. Specific guidance is given in 4.1.5.2.</li> <li>Step a) through step c) might require iteration to adjust within the specified range.</li> <li>Video averaging is not permitted. Where practical, a sample detection and single sweep mode shall be used. Otherwise, peak detection and max hold mode (until the trace stabilizes) shall be used.</li> <li>Use the 99% power bandwidth function of the instrument (if available) and report the measured bandwidth.</li> <li>If the instrument does not have a 99% power bandwidth function, then the trace data points are recovered and directly summed in linear power terms. The recovered amplitude data points,</li> </ol>



	<p>beginning at the lowest frequency, are placed in a running sum until 0.5% of the total is reached; that frequency is recorded as the lower frequency. The process is repeated until 99.5% of the total is reached; that frequency is recorded as the upper frequency. The 99% power bandwidth is the difference between these two frequencies.</p> <p>h) The occupied bandwidth shall be reported by providing plot(s) of the measuring instrument display; the plot axes and the scale units per division shall be clearly labeled. Tabular data may be reported in addition to the plot(s).</p> <p>6 dB emission bandwidth:</p> <ol style="list-style-type: none"> <li>a) Set RBW = 100 kHz.</li> <li>b) Set the video bandwidth (VBW) <math>\geq 3 \times</math> RBW.</li> <li>c) Detector = Peak.</li> <li>d) Trace mode = max hold.</li> <li>e) Sweep = auto couple.</li> <li>f) Allow the trace to stabilize.</li> <li>g) Measure the maximum width of the emission that is constrained by the frequencies associated with the two outermost amplitude points (upper and lower frequencies) that are attenuated by 6 dB relative to the maximum level measured in the fundamental emission.</li> </ol>
--	---

## 6.1. EUT Operation

Operating Environment:	
Test mode:	<ol style="list-style-type: none"> <li>1: 802.11a mode: Keep the EUT connect to AC power line and works in continuously transmitting mode with 802.11a modulation type. All data rates has been tested and found the data rate @ 6Mbps is the worst case. Only the data of worst case is recorded in the report.</li> <li>2: 802.11n mode: Keep the EUT connect to AC power line and works in continuously transmitting mode with 802.11n modulation type. All bandwidth and data rates has been tested and found the data rate @ MCS0 is the worst case. Only the data of worst case is recorded in the report.</li> <li>3: 802.11ac mode: Keep the EUT connect to AC power line and works in continuously transmitting mode with 802.11ac modulation type. All bandwidth and data rates has been tested and found the data rate @ MCS0 is the worst case. Only the data of worst case is recorded in the report.</li> <li>4: 802.11ax mode: Keep the EUT connect to AC power line and works in continuously transmitting mode with 802.11ax modulation type. All bandwidth and data rates has been tested and found the data rate @ MCS0 is the worst case. Only the data of worst case is recorded in the report.</li> </ol>





## 6.2. Test Setup

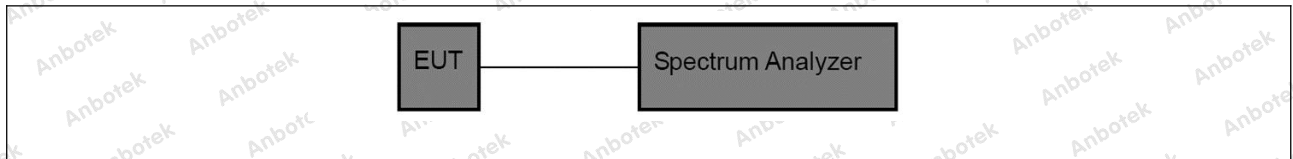

## 6.3. Test Data

Temperature:	24.6 °C	Humidity:	46 %	Atmospheric Pressure:	101 kPa
--------------	---------	-----------	------	-----------------------	---------

Please Refer to Appendix for Details.



## 7. Channel Move Time, Channel Closing Transmission Time

Test Requirement:	47 CFR Part 15.407(h)(2)(iii)
Test Limit:	Channel Move Time: within 10 seconds Channel Closing Transmission Time: 200 milliseconds + an aggregate of 60 milliseconds over remaining 10 second period. (The Channel Closing Transmission Time is comprised of 200 milliseconds starting at the beginning of the Channel Move Time plus any additional intermittent control signals required to facilitate a Channel move (an aggregate of 60 milliseconds) during the remainder of the 10 second period. The aggregate duration of control signals will not count quiet periods in between transmissions.)
Test Method:	KDB 905462 D02, Clause 7.8.3
Procedure:	<p>The steps below define the procedure to determine the above-mentioned parameters when a radar <i>Burst</i> with a level equal to the <i>DFS Detection Threshold</i> + 1dB is generated on the <i>Operating Channel</i> of the U-NII device (<i>In-Service Monitoring</i>).</p> <ol style="list-style-type: none"> <li>One frequency will be chosen from the <i>Operating Channels</i> of the UUT within the 5250-5350 MHz or 5470-5725 MHz bands. For 802.11 devices, the test frequency must contain control signals. This can be verified by disabling channel loading and monitoring the spectrum analyzer. If no control signals are detected, another frequency must be selected within the emission bandwidth where control signals are detected.</li> <li>In case the UUT is a U-NII device operating as a <i>Client Device</i> (with or without DFS), a U-NII device operating as a <i>Master Device</i> will be used to allow the UUT (Client device) to <i>Associate</i> with the <i>Master Device</i>. In case the UUT is a <i>Master Device</i>, a U-NII device operating as a <i>Client Device</i> will be used and it is assumed that the Client will <i>Associate</i> with the UUT (Master). In both cases for conducted tests, the <i>Radar Waveform</i> generator will be connected to the <i>Master Device</i>. For radiated tests, the emissions of the <i>Radar Waveform</i> generator will be directed towards the <i>Master Device</i>. If the <i>Master Device</i> has antenna gain, the main beam of the antenna will be directed toward the radar emitter. Vertical polarization is used for testing.</li> <li>Stream the channel loading test file from the <i>Master Device</i> to the <i>Client Device</i> on the test <i>Channel</i> for the entire period of the test.</li> <li>At time T0 the <i>Radar Waveform</i> generator sends a <i>Burst</i> of pulses for one of the Radar Type 0 in <b>Table 5</b> at levels defined in <b>Table 3</b>, on the <i>Operating Channel</i>. An additional 1 dB is added to the radar test signal to ensure it is at or above the <i>DFS Detection Threshold</i>, accounting for equipment variations/errors.</li> <li>Observe the transmissions of the UUT at the end of the radar <i>Burst</i> on the <i>Operating Channel</i> for duration greater than 10 seconds. Measure and record the transmissions from the UUT during the observation time (<i>Channel Move Time</i>). Measure and record the <i>Channel Move Time</i> and <i>Channel Closing Transmission Time</i> if radar detection occurs. <b>Figure 17</b> illustrates <i>Channel Closing Transmission Time</i>.</li> <li>When operating as a <i>Master Device</i>, monitor the UUT for more than 30 minutes following instant T2 to verify that the UUT does not resume any transmissions on this <i>Channel</i>. Perform this test once and record the measurement result.</li> <li>In case the UUT is a U-NII device operating as a <i>Client Device</i> with <i>In-Service Monitoring</i>, perform steps 1 to 6.</li> </ol>



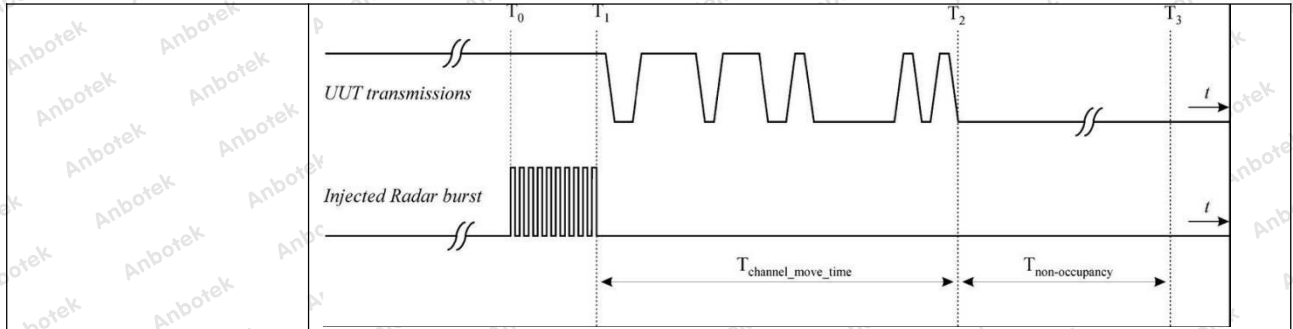

Figure 17: Example of Channel Closing Transmission Time & Channel Closing Time

7. The time for the EUT to fully restart up is 65s.

8. The time for the master device to fully restart up is 65s.

### 7.1. EUT Operation

Operating Environment:

Test mode: 5: Normal Operating: Keep the EUT works in normal operating mode and connect to companion device

### 7.2. Test Setup

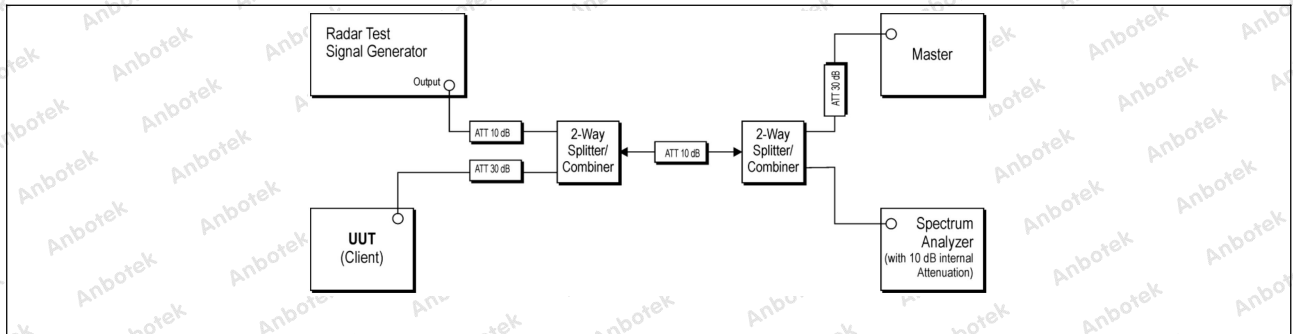

### 7.3. ATest Data

Temperature:	24.6 °C	Humidity:	46 %	Atmospheric Pressure:	101 kPa
--------------	---------	-----------	------	-----------------------	---------

Please Refer to Appendix for Details.





## 8. DFS Detection Thresholds

Test Requirement:	KDB 905462 D02, Clause 5.2 Table 3								
Test Limit:	<p>Table 3: DFS Detection Thresholds for Master Devices and Client Devices with Radar Detection</p> <p style="text-align: center;"><b>Table 3: DFS Detection Thresholds for Master Devices and Client Devices with Radar Detection</b></p> <table border="1"> <thead> <tr> <th>Maximum Transmit Power</th> <th>Value (See Notes 1, 2, and 3)</th> </tr> </thead> <tbody> <tr> <td>EIRP ≥ 200 milliwatt</td> <td>-64 dBm</td> </tr> <tr> <td>EIRP &lt; 200 milliwatt and power spectral density &lt; 10 dBm/MHz</td> <td>-62 dBm</td> </tr> <tr> <td>EIRP &lt; 200 milliwatt that do not meet the power spectral density requirement</td> <td>-64 dBm</td> </tr> </tbody> </table> <p><b>Note 1:</b> This is the level at the input of the receiver assuming a 0 dBi receive antenna.  <b>Note 2:</b> Throughout these test procedures an additional 1 dB has been added to the amplitude of the test transmission waveforms to account for variations in measurement equipment. This will ensure that the test signal is at or above the detection threshold level to trigger a DFS response.  <b>Note 3:</b> EIRP is based on the highest antenna gain. For MIMO devices refer to KDB Publication 662911 D01.</p>	Maximum Transmit Power	Value (See Notes 1, 2, and 3)	EIRP ≥ 200 milliwatt	-64 dBm	EIRP < 200 milliwatt and power spectral density < 10 dBm/MHz	-62 dBm	EIRP < 200 milliwatt that do not meet the power spectral density requirement	-64 dBm
Maximum Transmit Power	Value (See Notes 1, 2, and 3)								
EIRP ≥ 200 milliwatt	-64 dBm								
EIRP < 200 milliwatt and power spectral density < 10 dBm/MHz	-62 dBm								
EIRP < 200 milliwatt that do not meet the power spectral density requirement	-64 dBm								
Test Method:	KDB 905462 D02, Clause 7.4.1.1								
Procedure:	<p>1) A 50 ohm load is connected in place of the spectrum analyzer, and the spectrum analyzer is connected to place of the master</p> <p>2) The interference Radar Detection Threshold Level is TH+ 0dBi +1dB that had been taken into account the output power range and antenna gain.</p> <p>3) The following equipment setup was used to calibrate the conducted radar waveform. A vector signal generator was utilized to establish the test signal level for radar type 0. During this process, there were no transmissions by either the master or client device. The spectrum analyzer was switched to the zero spans (time domain) at the frequency of the radar waveform generator. Peak detection was used. The spectrum analyzer resolution bandwidth (RBW) and video bandwidth (VBW) were set to 3 MHz. The spectrum analyzer had offset -1.0dB to compensate RF cable loss 1.0dB.</p> <p>4) The vector signal generator amplitude was set so that the power level measured at the spectrum analyzer was TH + 0dBi +1dB = -63dBm. Capture the spectrum analyzer plots on short pulse radar waveform.</p> <p>Note: TH=-64 dBm or -62 dBm</p>								

### 8.1. EUT Operation

Operating Environment:	
Test mode:	5: Normal Operating: Keep the EUT works in normal operating mode and connect to companion device



## 8.2. Test Setup

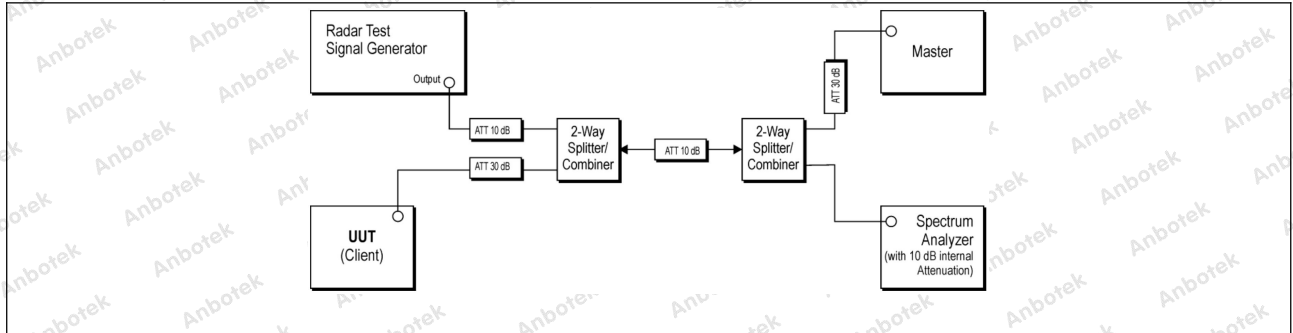

## 8.3. Test Data

Temperature:	24.6 °C	Humidity:	46 %	Atmospheric Pressure:	101 kPa
--------------	---------	-----------	------	-----------------------	---------

Please Refer to Appendix for Details.



## 9. Band edge emissions (Radiated)

<p>Test Requirement:</p>	<p>47 CFR Part 15.407(b)(1) 47 CFR Part 15.407(b)(2) 47 CFR Part 15.407(b)(3) 47 CFR Part 15.407(b)(4) 47 CFR Part 15.407(b)(10)</p>																																																																											
<p>Test Limit:</p>	<p>For transmitters operating in the 5.15-5.25 GHz band: All emissions outside of the 5.15-5.35 GHz band shall not exceed an e.i.r.p. of -27 dBm/MHz.</p> <p>For transmitters operating in the 5.25-5.35 GHz band: All emissions outside of the 5.15-5.35 GHz band shall not exceed an e.i.r.p. of -27 dBm/MHz.</p> <p>For transmitters operating in the 5.47-5.725 GHz band: All emissions outside of the 5.47-5.725 GHz band shall not exceed an e.i.r.p. of -27 dBm/MHz.</p> <p>For transmitters operating solely in the 5.725-5.850 GHz band: All emissions shall be limited to a level of -27 dBm/MHz at 75 MHz or more above or below the band edge increasing linearly to 10 dBm/MHz at 25 MHz above or below the band edge, and from 25 MHz above or below the band edge increasing linearly to a level of 15.6 dBm/MHz at 5 MHz above or below the band edge, and from 5 MHz above or below the band edge increasing linearly to a level of 27 dBm/MHz at the band edge.</p> <table border="1" data-bbox="491 1070 1433 1832"> <thead> <tr> <th>MHz</th> <th>MHz</th> <th>MHz</th> <th>GHz</th> </tr> </thead> <tbody> <tr> <td>0.090-0.110</td> <td>16.42-16.423</td> <td>399.9-410</td> <td>4.5-5.15</td> </tr> <tr> <td><sup>1</sup>0.495-0.505</td> <td>16.69475-16.69525</td> <td>608-614</td> <td>5.35-5.46</td> </tr> <tr> <td>2.1735-2.1905</td> <td>16.80425-16.80475</td> <td>960-1240</td> <td>7.25-7.75</td> </tr> <tr> <td>4.125-4.128</td> <td>25.5-25.67</td> <td>1300-1427</td> <td>8.025-8.5</td> </tr> <tr> <td>4.17725-4.17775</td> <td>37.5-38.25</td> <td>1435-1626.5</td> <td>9.0-9.2</td> </tr> <tr> <td>4.20725-4.20775</td> <td>73-74.6</td> <td>1645.5-1646.5</td> <td>9.3-9.5</td> </tr> <tr> <td>6.215-6.218</td> <td>74.8-75.2</td> <td>1660-1710</td> <td>10.6-12.7</td> </tr> <tr> <td>6.26775-6.26825</td> <td>108-121.94</td> <td>1718.8-1722.2</td> <td>13.25-13.4</td> </tr> <tr> <td>6.31175-6.31225</td> <td>123-138</td> <td>2200-2300</td> <td>14.47-14.5</td> </tr> <tr> <td>8.291-8.294</td> <td>149.9-150.05</td> <td>2310-2390</td> <td>15.35-16.2</td> </tr> <tr> <td>8.362-8.366</td> <td>156.52475-156.52525</td> <td>2483.5-2500</td> <td>17.7-21.4</td> </tr> <tr> <td>8.37625-8.38675</td> <td>156.7-156.9</td> <td>2690-2900</td> <td>22.01-23.12</td> </tr> <tr> <td>8.41425-8.41475</td> <td>162.0125-167.17</td> <td>3260-3267</td> <td>23.6-24.0</td> </tr> <tr> <td>12.29-12.293</td> <td>167.72-173.2</td> <td>3332-3339</td> <td>31.2-31.8</td> </tr> <tr> <td>12.51975-12.52025</td> <td>240-285</td> <td>3345.8-3358</td> <td>36.43-36.5</td> </tr> <tr> <td>12.57675-12.57725</td> <td>322-335.4</td> <td>3600-4400</td> <td>(<sup>2</sup>)</td> </tr> <tr> <td>13.36-13.41</td> <td></td> <td></td> <td></td> </tr> </tbody> </table> <p><sup>1</sup>Until February 1, 1999, this restricted band shall be 0.490-0.510 MHz.</p> <p><sup>2</sup>Above 38.6</p>				MHz	MHz	MHz	GHz	0.090-0.110	16.42-16.423	399.9-410	4.5-5.15	<sup>1</sup> 0.495-0.505	16.69475-16.69525	608-614	5.35-5.46	2.1735-2.1905	16.80425-16.80475	960-1240	7.25-7.75	4.125-4.128	25.5-25.67	1300-1427	8.025-8.5	4.17725-4.17775	37.5-38.25	1435-1626.5	9.0-9.2	4.20725-4.20775	73-74.6	1645.5-1646.5	9.3-9.5	6.215-6.218	74.8-75.2	1660-1710	10.6-12.7	6.26775-6.26825	108-121.94	1718.8-1722.2	13.25-13.4	6.31175-6.31225	123-138	2200-2300	14.47-14.5	8.291-8.294	149.9-150.05	2310-2390	15.35-16.2	8.362-8.366	156.52475-156.52525	2483.5-2500	17.7-21.4	8.37625-8.38675	156.7-156.9	2690-2900	22.01-23.12	8.41425-8.41475	162.0125-167.17	3260-3267	23.6-24.0	12.29-12.293	167.72-173.2	3332-3339	31.2-31.8	12.51975-12.52025	240-285	3345.8-3358	36.43-36.5	12.57675-12.57725	322-335.4	3600-4400	( <sup>2</sup> )	13.36-13.41			
MHz	MHz	MHz	GHz																																																																									
0.090-0.110	16.42-16.423	399.9-410	4.5-5.15																																																																									
<sup>1</sup> 0.495-0.505	16.69475-16.69525	608-614	5.35-5.46																																																																									
2.1735-2.1905	16.80425-16.80475	960-1240	7.25-7.75																																																																									
4.125-4.128	25.5-25.67	1300-1427	8.025-8.5																																																																									
4.17725-4.17775	37.5-38.25	1435-1626.5	9.0-9.2																																																																									
4.20725-4.20775	73-74.6	1645.5-1646.5	9.3-9.5																																																																									
6.215-6.218	74.8-75.2	1660-1710	10.6-12.7																																																																									
6.26775-6.26825	108-121.94	1718.8-1722.2	13.25-13.4																																																																									
6.31175-6.31225	123-138	2200-2300	14.47-14.5																																																																									
8.291-8.294	149.9-150.05	2310-2390	15.35-16.2																																																																									
8.362-8.366	156.52475-156.52525	2483.5-2500	17.7-21.4																																																																									
8.37625-8.38675	156.7-156.9	2690-2900	22.01-23.12																																																																									
8.41425-8.41475	162.0125-167.17	3260-3267	23.6-24.0																																																																									
12.29-12.293	167.72-173.2	3332-3339	31.2-31.8																																																																									
12.51975-12.52025	240-285	3345.8-3358	36.43-36.5																																																																									
12.57675-12.57725	322-335.4	3600-4400	( <sup>2</sup> )																																																																									
13.36-13.41																																																																												





	<p>The field strength of emissions appearing within these frequency bands shall not exceed the limits shown in § 15.209. At frequencies equal to or less than 1000 MHz, compliance with the limits in § 15.209 shall be demonstrated using measurement instrumentation employing a CISPR quasi-peak detector. Above 1000 MHz, compliance with the emission limits in § 15.209 shall be demonstrated based on the average value of the measured emissions. The provisions in § 15.35 apply to these measurements.</p> <p>Except as provided elsewhere in this subpart, the emissions from an intentional radiator shall not exceed the field strength levels specified in the following table:</p> <table border="1" data-bbox="491 672 1433 1003"> <thead> <tr> <th>Frequency (MHz)</th> <th>Field strength (microvolts/meter)</th> <th>Measurement distance (meters)</th> </tr> </thead> <tbody> <tr> <td>0.009-0.490</td> <td>2400/F(kHz)</td> <td>300</td> </tr> <tr> <td>0.490-1.705</td> <td>24000/F(kHz)</td> <td>30</td> </tr> <tr> <td>1.705-30.0</td> <td>30</td> <td>30</td> </tr> <tr> <td>30-88</td> <td>100 **</td> <td>3</td> </tr> <tr> <td>88-216</td> <td>150 **</td> <td>3</td> </tr> <tr> <td>216-960</td> <td>200 **</td> <td>3</td> </tr> <tr> <td>Above 960</td> <td>500</td> <td>3</td> </tr> </tbody> </table> <p>** Except as provided in paragraph (g), fundamental emissions from intentional radiators operating under this section shall not be located in the frequency bands 54-72 MHz, 76-88 MHz, 174-216 MHz or 470-806 MHz. However, operation within these frequency bands is permitted under other sections of this part, e.g., §§ 15.231 and 15.241. In the emission table above, the tighter limit applies at the band edges. The emission limits shown in the above table are based on measurements employing a CISPR quasi-peak detector except for the frequency bands 9–90 kHz, 110–490 kHz and above 1000 MHz. Radiated emission limits in these three bands are based on measurements employing an average detector.</p>	Frequency (MHz)	Field strength (microvolts/meter)	Measurement distance (meters)	0.009-0.490	2400/F(kHz)	300	0.490-1.705	24000/F(kHz)	30	1.705-30.0	30	30	30-88	100 **	3	88-216	150 **	3	216-960	200 **	3	Above 960	500	3
Frequency (MHz)	Field strength (microvolts/meter)	Measurement distance (meters)																							
0.009-0.490	2400/F(kHz)	300																							
0.490-1.705	24000/F(kHz)	30																							
1.705-30.0	30	30																							
30-88	100 **	3																							
88-216	150 **	3																							
216-960	200 **	3																							
Above 960	500	3																							
<p>Test Method:</p>	<p>ANSI C63.10-2020, section 12.7.4, 12.7.6, 12.7.7</p>																								
<p>Procedure:</p>	<p>Above 1GHz:</p> <ol style="list-style-type: none"> <li>For above 1GHz, the EUT was placed on the top of a rotating table 1.5 meters above the ground at a 3 meter fully-anechoic chamber. The table was rotated 360 degrees to determine the position of the highest radiation.</li> <li>The EUT was set 3 meters away from the interference-receiving antenna, which was mounted on the top of a variable-height antenna tower.</li> <li>The antenna height is varied from one meter to four meters above the ground to determine the maximum value of the field strength. Both horizontal and vertical polarizations of the antenna are set to make the measurement.</li> <li>For each suspected emission, the EUT was arranged to its worst case and then the antenna was tuned to heights from 1 meter to 4 meters (for the test frequency of below 30MHz, the antenna was tuned to heights 1 meter) and the rotatable table was turned from 0 degrees to 360 degrees to find the maximum reading.</li> <li>The test-receiver system was set to Peak Detect Function and Specified Bandwidth with Maximum Hold Mode.</li> <li>If the emission level of the EUT in peak mode was 10dB lower than the limit specified, then testing could be stopped and the peak values of the EUT</li> </ol>																								



	<p>would be reported. Otherwise the emissions that did not have 10dB margin would be re-tested one by one using peak or average method as specified and then reported in a data sheet.</p> <p>g. Test the EUT in the lowest channel, the middle channel, the Highest channel.</p> <p>h. The radiation measurements are performed in X, Y, Z axis positioning for Transmitting mode, and found the X axis positioning which it is the worst case.</p> <p>i. Repeat above procedures until all frequencies measured was complete.</p> <p>Remark:</p> <ol style="list-style-type: none"> <li>1. Level= Read Level+ Cable Loss+ Antenna Factor- Preamp Factor</li> <li>2. Scan from 18GHz to 40GHz, the disturbance above 18GHz was very low. The points marked on above plots are the highest emissions could be found when testing, so only above points had been displayed. The amplitude of spurious emissions from the radiator which are attenuated more than 20dB below the limit need not be reported.</li> <li>3. As shown in this section, for frequencies above 1GHz, the field strength limits are based on average limits. However, the peak field strength of any emission shall not exceed the maximum permitted average limits specified above by more than 20 dB under any condition of modulation. For the emissions whose peak level is lower than the average limit, only the peak measurement is shown in the report.</li> <li>4. The disturbance above 18GHz were very low and the harmonics were the highest point could be found when testing, so only the above harmonics had been displayed.</li> </ol>
--	---

## 9.1. EUT Operation

Operating Environment:	
	<p>1: 802.11a mode: Keep the EUT connect to AC power line and works in continuously transmitting mode with 802.11a modulation type. All data rates has been tested and found the data rate @ 6Mbps is the worst case. Only the data of worst case is recorded in the report.</p> <p>2: 802.11n mode: Keep the EUT connect to AC power line and works in continuously transmitting mode with 802.11n modulation type. All bandwidth and data rates has been tested and found the data rate @ MCS0 is the worst case. Only the data of worst case is recorded in the report.</p> <p>3: 802.11ac mode: Keep the EUT connect to AC power line and works in continuously transmitting mode with 802.11ac modulation type. All bandwidth and data rates has been tested and found the data rate @ MCS0 is the worst case. Only the data of worst case is recorded in the report.</p> <p>4: 802.11ax mode: Keep the EUT connect to AC power line and works in continuously transmitting mode with 802.11ax modulation type. All bandwidth and data rates has been tested and found the data rate @ MCS0 is the worst case. Only the data of worst case is recorded in the report.</p>
Test mode:	



## 9.2. Test Setup

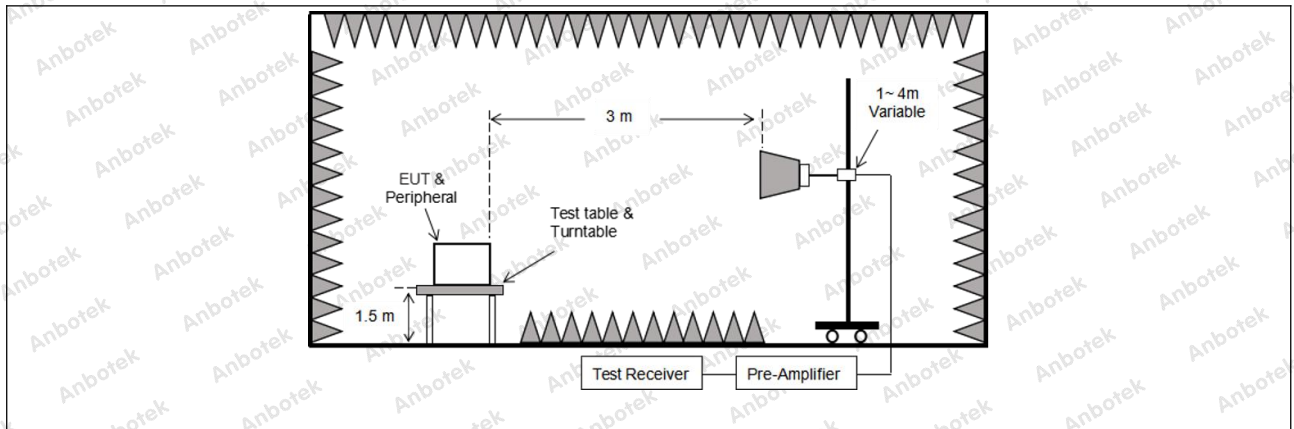

### Shenzhen Anbotek Compliance Laboratory Limited

Address: 1/F., Building D, Sogood Science and Technology Park, Sanwei Community, Hangcheng Street, Bao'an District, Shenzhen, Guangdong, China.  
Tel: (86)0755-26066440 Fax: (86)0755-26014772 Email: service@anbotek.com

Hotline  
400-003-0500  
www.anbotek.com.cn





**9.3. Test Data**

Temperature:	24.6 °C	Humidity:	46 %	Atmospheric Pressure:	101 kPa
--------------	---------	-----------	------	-----------------------	---------

TM1 / Band: 5150-5350 MHz / BW: 20 / L							
Frequency (MHz)	Reading (dBuV)	Factor (dB/m)	Result (dBuV/m)	Limit (dBuV/m)	Over limit (dB)	Antenna Pol.	Detector
5150.00	37.16	15.99	53.15	68.20	-15.05	H	Peak
5150.00	39.26	15.99	55.25	68.20	-12.95	V	Peak
5150.00	27.05	15.99	43.04	54.00	-10.96	H	AVG
5150.00	29.15	15.99	45.14	54.00	-8.86	V	AVG
TM1 / Band: 5150-5350 MHz / BW: 20 / H							
Frequency (MHz)	Reading (dBuV)	Factor (dB/m)	Result (dBuV/m)	Limit (dBuV/m)	Over limit (dB)	Antenna Pol.	Detector
5350.00	37.56	16.43	53.99	68.20	-14.21	H	Peak
5350.00	40.62	16.43	57.05	68.20	-11.15	V	Peak
5350.00	28.95	16.43	45.38	54.00	-8.62	H	AVG
5350.00	29.78	16.43	46.21	54.00	-7.79	V	AVG

Remark:

1. Result=Reading + Factor
2. During the test, all antenna chains has been tested, and only worst case (ANT1) data is listed in the report.

TM2 / Band: 5150-5350 MHz / BW: 20 / L							
Frequency (MHz)	Reading (dBuV)	Factor (dB/m)	Result (dBuV/m)	Limit (dBuV/m)	Over limit (dB)	Antenna Pol.	Detector
5150.00	36.04	15.99	52.03	68.20	-16.17	H	Peak
5150.00	37.48	15.99	53.47	68.20	-14.73	V	Peak
5150.00	26.76	15.99	42.75	54.00	-11.25	H	AVG
5150.00	27.73	15.99	43.72	54.00	-10.28	V	AVG
TM2 / Band: 5150-5350 MHz / BW: 20 / H							
Frequency (MHz)	Reading (dBuV)	Factor (dB/m)	Result (dBuV/m)	Limit (dBuV/m)	Over limit (dB)	Antenna Pol.	Detector
5350.00	37.89	16.43	54.32	68.20	-13.88	H	Peak
5350.00	38.90	16.43	55.33	68.20	-12.87	V	Peak
5350.00	27.94	16.43	44.37	54.00	-9.63	H	AVG
5350.00	29.44	16.43	45.87	54.00	-8.13	V	AVG

Remark:

1. Result=Reading + Factor
2. During the test, SISO and MIMO modes have been tested, and only worst case (MIMO) data is listed in the report.

**Shenzhen Anbotek Compliance Laboratory Limited**

Address: 1/F., Building D, Sogood Science and Technology Park, Sanwei Community, Hangcheng Street, Bao'an District, Shenzhen, Guangdong, China.  
Tel: (86)0755-26066440 Fax: (86)0755-26014772 Email: service@anbotek.com



Hotline  
400-003-0500  
www.anbotek.com.cn



TM2 / Band: 5150-5350 MHz / BW: 40 / L							
Frequency (MHz)	Reading (dBuV)	Factor (dB/m)	Result (dBuV/m)	Limit (dBuV/m)	Over limit (dB)	Antenna Pol.	Detector
5150.00	36.67	15.99	52.66	68.20	-15.54	H	Peak
5150.00	38.50	15.99	54.49	68.20	-13.71	V	Peak
5150.00	27.25	15.99	43.24	54.00	-10.76	H	AVG
5150.00	28.83	15.99	44.82	54.00	-9.18	V	AVG
TM2 / Band: 5150-5350 MHz / BW: 40 / H							
Frequency (MHz)	Reading (dBuV)	Factor (dB/m)	Result (dBuV/m)	Limit (dBuV/m)	Over limit (dB)	Antenna Pol.	Detector
5350.00	38.21	16.43	54.64	68.20	-13.56	H	Peak
5350.00	37.03	16.43	53.46	68.20	-14.74	V	Peak
5350.00	28.50	16.43	44.93	54.00	-9.07	H	AVG
5350.00	29.74	16.43	46.17	54.00	-7.83	V	AVG

## Remark:

1. Result=Reading + Factor
2. During the test, SISO and MIMO modes have been tested, and only worst case (MIMO) data is listed in the report.

TM3 / Band: 5150-5350 MHz / BW: 20 / L							
Frequency (MHz)	Reading (dBuV)	Factor (dB/m)	Result (dBuV/m)	Limit (dBuV/m)	Over limit (dB)	Antenna Pol.	Detector
5150.00	37.14	15.99	53.13	68.20	-15.07	H	Peak
5150.00	38.93	15.99	54.92	68.20	-13.28	V	Peak
5150.00	26.67	15.99	42.66	54.00	-11.34	H	AVG
5150.00	28.93	15.99	44.92	54.00	-9.08	V	AVG
TM3 / Band: 5150-5350 MHz / BW: 20 / H							
Frequency (MHz)	Reading (dBuV)	Factor (dB/m)	Result (dBuV/m)	Limit (dBuV/m)	Over limit (dB)	Antenna Pol.	Detector
5350.00	37.99	16.43	54.42	68.20	-13.78	H	Peak
5350.00	38.22	16.43	54.65	68.20	-13.55	V	Peak
5350.00	27.93	16.43	44.36	54.00	-9.64	H	AVG
5350.00	28.56	16.43	44.99	54.00	-9.01	V	AVG

## Remark:

1. Result=Reading + Factor
2. During the test, SISO and MIMO modes have been tested, and only worst case (MIMO) data is listed in the report.

## Shenzhen Anbotek Compliance Laboratory Limited

Address: 1/F., Building D, Sogood Science and Technology Park, Sanwei Community, Hangcheng Street, Bao'an District, Shenzhen, Guangdong, China.  
Tel: (86)0755-26066440 Fax: (86)0755-26014772 Email: service@anbotek.com



Hotline  
400-003-0500  
www.anbotek.com.cn



TM3 / Band: 5150-5350 MHz / BW: 40 / L							
Frequency (MHz)	Reading (dBuV)	Factor (dB/m)	Result (dBuV/m)	Limit (dBuV/m)	Over limit (dB)	Antenna Pol.	Detector
5150.00	36.08	15.99	52.07	68.20	-16.13	H	Peak
5150.00	36.46	15.99	52.45	68.20	-15.75	V	Peak
5150.00	26.34	15.99	42.33	54.00	-11.67	H	AVG
5150.00	27.00	15.99	42.99	54.00	-11.01	V	AVG
TM3 / Band: 5150-5350 MHz / BW: 40 / H							
Frequency (MHz)	Reading (dBuV)	Factor (dB/m)	Result (dBuV/m)	Limit (dBuV/m)	Over limit (dB)	Antenna Pol.	Detector
5350.00	38.19	16.43	54.62	68.20	-13.58	H	Peak
5350.00	37.29	16.43	53.72	68.20	-14.48	V	Peak
5350.00	27.60	16.43	44.03	54.00	-9.97	H	AVG
5350.00	27.72	16.43	44.15	54.00	-9.85	V	AVG

**Remark:**

1. Result=Reading + Factor
2. During the test, SISO and MIMO modes have been tested, and only worst case (MIMO) data is listed in the report.

TM3 / Band: 5150-5350 MHz / BW: 80 / L							
Frequency (MHz)	Reading (dBuV)	Factor (dB/m)	Result (dBuV/m)	Limit (dBuV/m)	Over limit (dB)	Antenna Pol.	Detector
5150.00	36.13	15.99	52.12	68.20	-16.08	H	Peak
5150.00	36.67	15.99	52.66	68.20	-15.54	V	Peak
5150.00	26.82	15.99	42.81	54.00	-11.19	H	AVG
5150.00	27.01	15.99	43.00	54.00	-11.00	V	AVG
TM3 / Band: 5150-5350 MHz / BW: 80 / H							
Frequency (MHz)	Reading (dBuV)	Factor (dB/m)	Result (dBuV/m)	Limit (dBuV/m)	Over limit (dB)	Antenna Pol.	Detector
5350.00	38.53	16.43	54.96	68.20	-13.24	H	Peak
5350.00	37.63	16.43	54.06	68.20	-14.14	V	Peak
5350.00	29.07	16.43	45.50	54.00	-8.50	H	AVG
5350.00	28.28	16.43	44.71	54.00	-9.29	V	AVG

**Remark:**

1. Result=Reading + Factor
2. During the test, SISO and MIMO modes have been tested, and only worst case (MIMO) data is listed in the report.





TM4 / Band: 5150-5350 MHz / BW: 20 / L							
Frequency (MHz)	Reading (dBuV)	Factor (dB/m)	Result (dBuV/m)	Limit (dBuV/m)	Over limit (dB)	Antenna Pol.	Detector
5150.00	37.33	15.99	53.32	68.20	-14.88	H	Peak
5150.00	39.14	15.99	55.13	68.20	-13.07	V	Peak
5150.00	26.77	15.99	42.76	54.00	-11.24	H	AVG
5150.00	29.09	15.99	45.08	54.00	-8.92	V	AVG
TM4 / Band: 5150-5350 MHz / BW: 20 / H							
Frequency (MHz)	Reading (dBuV)	Factor (dB/m)	Result (dBuV/m)	Limit (dBuV/m)	Over limit (dB)	Antenna Pol.	Detector
5350.00	38.09	16.43	54.52	68.20	-13.68	H	Peak
5350.00	38.31	16.43	54.74	68.20	-13.46	V	Peak
5350.00	28.06	16.43	44.49	54.00	-9.51	H	AVG
5350.00	28.75	16.43	45.18	54.00	-8.82	V	AVG

## Remark:

1. Result=Reading + Factor
2. During the test, SISO and MIMO modes have been tested, and only worst case (MIMO) data is listed in the report.

TM4 / Band: 5150-5350 MHz / BW: 40 / L							
Frequency (MHz)	Reading (dBuV)	Factor (dB/m)	Result (dBuV/m)	Limit (dBuV/m)	Over limit (dB)	Antenna Pol.	Detector
5150.00	36.25	15.99	52.24	68.20	-15.96	H	Peak
5150.00	36.57	15.99	52.56	68.20	-15.64	V	Peak
5150.00	26.58	15.99	42.57	54.00	-11.43	H	AVG
5150.00	27.17	15.99	43.16	54.00	-10.84	V	AVG
TM4 / Band: 5150-5350 MHz / BW: 40 / H							
Frequency (MHz)	Reading (dBuV)	Factor (dB/m)	Result (dBuV/m)	Limit (dBuV/m)	Over limit (dB)	Antenna Pol.	Detector
5350.00	38.33	16.43	54.76	68.20	-13.44	H	Peak
5350.00	37.39	16.43	53.82	68.20	-14.38	V	Peak
5350.00	27.70	16.43	44.13	54.00	-9.87	H	AVG
5350.00	27.95	16.43	44.38	54.00	-9.62	V	AVG

## Remark:

1. Result=Reading + Factor
2. During the test, SISO and MIMO modes have been tested, and only worst case (MIMO) data is listed in the report.

## Shenzhen Anbotek Compliance Laboratory Limited

Address: 1/F., Building D, Sogood Science and Technology Park, Sanwei Community, Hangcheng Street, Bao'an District, Shenzhen, Guangdong, China.  
Tel: (86)0755-26066440 Fax: (86)0755-26014772 Email: service@anbotek.com



Hotline  
400-003-0500  
www.anbotek.com.cn



TM4 / Band: 5150-5350 MHz / BW: 80 / L							
Frequency (MHz)	Reading (dBuV)	Factor (dB/m)	Result (dBuV/m)	Limit (dBuV/m)	Over limit (dB)	Antenna Pol.	Detector
5150.00	36.23	15.99	52.22	68.20	-15.98	H	Peak
5150.00	36.88	15.99	52.87	68.20	-15.33	V	Peak
5150.00	27.05	15.99	43.04	54.00	-10.96	H	AVG
5150.00	27.17	15.99	43.16	54.00	-10.84	V	AVG
TM4 / Band: 5150-5350 MHz / BW: 80 / H							
Frequency (MHz)	Reading (dBuV)	Factor (dB/m)	Result (dBuV/m)	Limit (dBuV/m)	Over limit (dB)	Antenna Pol.	Detector
5350.00	38.74	16.43	55.17	68.20	-13.03	H	Peak
5350.00	37.80	16.43	54.23	68.20	-13.97	V	Peak
5350.00	29.33	16.43	45.76	54.00	-8.24	H	AVG
5350.00	28.44	16.43	44.87	54.00	-9.13	V	AVG

**Remark:**

1. Result=Reading + Factor
2. During the test, SISO and MIMO modes have been tested, and only worst case (MIMO) data is listed in the report.

**Shenzhen Anbotek Compliance Laboratory Limited**

Address: 1/F., Building D, Sogood Science and Technology Park, Sanwei Community, Hangcheng Street, Bao'an District, Shenzhen, Guangdong, China.  
 Tel: (86)0755-26066440 Fax: (86)0755-26014772 Email: service@anbotek.com

Hotline  
 400-003-0500  
 www.anbotek.com.cn



TM1 / Band: 5470-5850 MHz / BW: 20 / L							
Frequency (MHz)	Reading (dBuV)	Factor (dB/m)	Result (dBuV/m)	Limit (dBuV/m)	Over limit (dB)	Antenna Pol.	Detector
5460.00	38.19	16.37	54.56	68.20	-13.64	H	Peak
5460.00	39.58	16.37	55.95	68.20	-12.25	V	Peak
5470.00	39.12	16.70	55.82	68.20	-12.38	H	Peak
5470.00	39.87	16.70	56.57	68.20	-11.63	V	Peak
5460.00	28.78	16.37	45.15	54.00	-8.85	H	AVG
5460.00	28.65	16.37	45.02	54.00	-8.98	V	AVG
5470.00	29.05	16.70	45.75	54.00	-8.25	H	AVG
5470.00	30.16	16.70	46.86	54.00	-7.14	V	AVG
TM1 / Band: 5470-5850 MHz / BW: 20 / H							
Frequency (MHz)	Reading (dBuV)	Factor (dB/m)	Result (dBuV/m)	Limit (dBuV/m)	Over limit (dB)	Antenna Pol.	Detector
5850.00	39.14	17.21	56.35	68.20	-11.85	H	Peak
5850.00	39.51	17.21	56.72	68.20	-11.48	V	Peak
5850.00	29.12	17.21	46.33	54.00	-7.67	H	AVG
5850.00	29.13	17.21	46.34	54.00	-7.66	V	AVG

Remark:

1. Result=Reading + Factor
2. During the test, all antenna chains has been tested, and only worst case (ANT1) data is listed in the report.

TM2 / Band: 5470-5850 MHz / BW: 20 / L							
Frequency (MHz)	Reading (dBuV)	Factor (dB/m)	Result (dBuV/m)	Limit (dBuV/m)	Over limit (dB)	Antenna Pol.	Detector
5460.00	38.17	16.37	54.54	68.20	-13.66	H	Peak
5460.00	38.75	16.37	55.12	68.20	-13.08	V	Peak
5470.00	38.28	16.70	54.98	68.20	-13.22	H	Peak
5470.00	38.70	16.70	55.40	68.20	-12.80	V	Peak
5460.00	27.17	16.37	43.54	54.00	-10.46	H	AVG
5460.00	27.60	16.37	43.97	54.00	-10.03	V	AVG
5470.00	27.61	16.70	44.31	54.00	-9.69	H	AVG
5470.00	28.14	16.70	44.84	54.00	-9.16	V	AVG
TM2 / Band: 5470-5850 MHz / BW: 20 / H							
Frequency (MHz)	Reading (dBuV)	Factor (dB/m)	Result (dBuV/m)	Limit (dBuV/m)	Over limit (dB)	Antenna Pol.	Detector
5850.00	37.38	17.21	54.59	68.20	-13.61	H	Peak
5850.00	37.99	17.21	55.20	68.20	-13.00	V	Peak
5850.00	27.66	17.21	44.87	54.00	-9.13	H	AVG
5850.00	28.48	17.21	45.69	54.00	-8.31	V	AVG

Remark:

1. Result=Reading + Factor
2. During the test, SISO and MIMO modes have been tested, and only worst case (MIMO) data is listed in the report.

#### Shenzhen Anbotek Compliance Laboratory Limited

Address: 1/F., Building D, Sogood Science and Technology Park, Sanwei Community, Hangcheng Street, Bao'an District, Shenzhen, Guangdong, China.  
Tel: (86)0755-26066440 Fax: (86)0755-26014772 Email: service@anbotek.com



Hotline  
400-003-0500  
www.anbotek.com.cn





TM2 / Band: 5470-5850 MHz / BW: 40 / L							
Frequency (MHz)	Reading (dBuV)	Factor (dB/m)	Result (dBuV/m)	Limit (dBuV/m)	Over limit (dB)	Antenna Pol.	Detector
5460.00	37.75	16.37	54.12	68.20	-14.08	H	Peak
5460.00	38.63	16.37	55.00	68.20	-13.20	V	Peak
5470.00	38.58	16.70	55.28	68.20	-12.92	H	Peak
5470.00	39.24	16.70	55.94	68.20	-12.26	V	Peak
5460.00	26.86	16.37	43.23	54.00	-10.77	H	AVG
5460.00	28.73	16.37	45.10	54.00	-8.90	V	AVG
5470.00	27.06	16.70	43.76	54.00	-10.24	H	AVG
5470.00	28.41	16.70	45.11	54.00	-8.89	V	AVG
TM2 / Band: 5470-5850 MHz / BW: 40 / H							
Frequency (MHz)	Reading (dBuV)	Factor (dB/m)	Result (dBuV/m)	Limit (dBuV/m)	Over limit (dB)	Antenna Pol.	Detector
5850.00	38.11	17.21	55.32	68.20	-12.88	H	Peak
5850.00	38.48	17.21	55.69	68.20	-12.51	V	Peak
5850.00	28.28	17.21	45.49	54.00	-8.51	H	AVG
5850.00	29.37	17.21	46.58	54.00	-7.42	V	AVG

Remark: 1. Result=Reading + Factor

TM3 / Band: 5470-5850 MHz / BW: 20 / L							
Frequency (MHz)	Reading (dBuV)	Factor (dB/m)	Result (dBuV/m)	Limit (dBuV/m)	Over limit (dB)	Antenna Pol.	Detector
5460.00	37.39	16.37	53.76	68.20	-14.44	H	Peak
5460.00	37.53	16.37	53.90	68.20	-14.30	V	Peak
5470.00	37.97	16.70	54.67	68.20	-13.53	H	Peak
5470.00	38.33	16.70	55.03	68.20	-13.17	V	Peak
5460.00	28.02	16.37	44.39	54.00	-9.61	H	AVG
5460.00	28.66	16.37	45.03	54.00	-8.97	V	AVG
5470.00	28.30	16.70	45.00	54.00	-9.00	H	AVG
5470.00	29.12	16.70	45.82	54.00	-8.18	V	AVG
TM3 / Band: 5470-5850 MHz / BW: 20 / H							
Frequency (MHz)	Reading (dBuV)	Factor (dB/m)	Result (dBuV/m)	Limit (dBuV/m)	Over limit (dB)	Antenna Pol.	Detector
5850.00	38.13	17.21	55.34	68.20	-12.86	H	Peak
5850.00	39.01	17.21	56.22	68.20	-11.98	V	Peak
5850.00	28.00	17.21	45.21	54.00	-8.79	H	AVG
5850.00	29.08	17.21	46.29	54.00	-7.71	V	AVG

Remark:

1. Result=Reading + Factor

2. During the test, SISO and MIMO modes have been tested, and only worst case (MIMO) data is listed in the report.

#### Shenzhen Anbotek Compliance Laboratory Limited

Address: 1/F., Building D, Sogood Science and Technology Park, Sanwei Community, Hangcheng Street, Bao'an District, Shenzhen, Guangdong, China.  
Tel: (86)0755-26066440 Fax: (86)0755-26014772 Email: service@anbotek.com



Hotline

400-003-0500

www.anbotek.com.cn



TM3 / Band: 5470-5850 MHz / BW: 40 / L							
Frequency (MHz)	Reading (dBuV)	Factor (dB/m)	Result (dBuV/m)	Limit (dBuV/m)	Over limit (dB)	Antenna Pol.	Detector
5460.00	36.33	16.37	52.70	68.20	-15.50	H	Peak
5460.00	37.85	16.37	54.22	68.20	-13.98	V	Peak
5470.00	36.76	16.70	53.46	68.20	-14.74	H	Peak
5470.00	38.19	16.70	54.89	68.20	-13.31	V	Peak
5460.00	27.33	16.37	43.70	54.00	-10.30	H	AVG
5460.00	27.46	16.37	43.83	54.00	-10.17	V	AVG
5470.00	27.58	16.70	44.28	54.00	-9.72	H	AVG
5470.00	28.27	16.70	44.97	54.00	-9.03	V	AVG
TM3 / Band: 5470-5850 MHz / BW: 40 / H							
Frequency (MHz)	Reading (dBuV)	Factor (dB/m)	Result (dBuV/m)	Limit (dBuV/m)	Over limit (dB)	Antenna Pol.	Detector
5850.00	37.68	17.21	54.89	68.20	-13.31	H	Peak
5850.00	38.52	17.21	55.73	68.20	-12.47	V	Peak
5850.00	27.68	17.21	44.89	54.00	-9.11	H	AVG
5850.00	27.31	17.21	44.52	54.00	-9.48	V	AVG

Remark: 1. Result=Reading + Factor

TM3 / Band: 5470-5850 MHz / BW: 80 / L							
Frequency (MHz)	Reading (dBuV)	Factor (dB/m)	Result (dBuV/m)	Limit (dBuV/m)	Over limit (dB)	Antenna Pol.	Detector
5460.00	35.61	16.37	51.98	68.20	-16.22	H	Peak
5460.00	37.14	16.37	53.51	68.20	-14.69	V	Peak
5470.00	35.97	16.70	52.67	68.20	-15.53	H	Peak
5470.00	38.09	16.70	54.79	68.20	-13.41	V	Peak
5460.00	25.88	16.37	42.25	54.00	-11.75	H	AVG
5460.00	26.99	16.37	43.36	54.00	-10.64	V	AVG
5470.00	26.63	16.70	43.33	54.00	-10.67	H	AVG
5470.00	27.20	16.70	43.90	54.00	-10.10	V	AVG
TM3 / Band: 5470-5850 MHz / BW: 80 / H							
Frequency (MHz)	Reading (dBuV)	Factor (dB/m)	Result (dBuV/m)	Limit (dBuV/m)	Over limit (dB)	Antenna Pol.	Detector
5850.00	37.65	17.21	54.86	68.20	-13.34	H	Peak
5850.00	37.94	17.21	55.15	68.20	-13.05	V	Peak
5850.00	28.05	17.21	45.26	54.00	-8.74	H	AVG
5850.00	28.31	17.21	45.52	54.00	-8.48	V	AVG

Remark:

1. Result=Reading + Factor
2. During the test, SISO and MIMO modes have been tested, and only worst case (MIMO) data is listed in the report.



TM4 / Band: 5470-5850 MHz / BW: 20 / L							
Frequency (MHz)	Reading (dBuV)	Factor (dB/m)	Result (dBuV/m)	Limit (dBuV/m)	Over limit (dB)	Antenna Pol.	Detector
5460.00	37.51	16.37	53.88	68.20	-14.32	H	Peak
5460.00	37.60	16.37	53.97	68.20	-14.23	V	Peak
5470.00	38.09	16.70	54.79	68.20	-13.41	H	Peak
5470.00	38.40	16.70	55.10	68.20	-13.10	V	Peak
5460.00	28.11	16.37	44.48	54.00	-9.52	H	AVG
5460.00	28.81	16.37	45.18	54.00	-8.82	V	AVG
5470.00	28.39	16.70	45.09	54.00	-8.91	H	AVG
5470.00	29.27	16.70	45.97	54.00	-8.03	V	AVG
TM4 / Band: 5470-5850 MHz / BW: 20 / H							
Frequency (MHz)	Reading (dBuV)	Factor (dB/m)	Result (dBuV/m)	Limit (dBuV/m)	Over limit (dB)	Antenna Pol.	Detector
5850.00	38.25	17.21	55.46	68.20	-12.74	H	Peak
5850.00	39.11	17.21	56.32	68.20	-11.88	V	Peak
5850.00	28.10	17.21	45.31	54.00	-8.69	H	AVG
5850.00	29.23	17.21	46.44	54.00	-7.56	V	AVG

Remark: 1. Result=Reading + Factor

TM4 / Band: 5470-5850 MHz / BW: 40 / L							
Frequency (MHz)	Reading (dBuV)	Factor (dB/m)	Result (dBuV/m)	Limit (dBuV/m)	Over limit (dB)	Antenna Pol.	Detector
5460.00	36.45	16.37	52.82	68.20	-15.38	H	Peak
5460.00	37.92	16.37	54.29	68.20	-13.91	V	Peak
5470.00	36.88	16.70	53.58	68.20	-14.62	H	Peak
5470.00	38.26	16.70	54.96	68.20	-13.24	V	Peak
5460.00	27.42	16.37	43.79	54.00	-10.21	H	AVG
5460.00	27.53	16.37	43.90	54.00	-10.10	V	AVG
5470.00	27.67	16.70	44.37	54.00	-9.63	H	AVG
5470.00	28.34	16.70	45.04	54.00	-8.96	V	AVG
TM4 / Band: 5470-5850 MHz / BW: 40 / H							
Frequency (MHz)	Reading (dBuV)	Factor (dB/m)	Result (dBuV/m)	Limit (dBuV/m)	Over limit (dB)	Antenna Pol.	Detector
5850.00	37.78	17.21	54.99	68.20	-13.21	H	Peak
5850.00	38.67	17.21	55.88	68.20	-12.32	V	Peak
5850.00	27.80	17.21	45.01	54.00	-8.99	H	AVG
5850.00	27.46	17.21	44.67	54.00	-9.33	V	AVG

Remark:

1. Result=Reading + Factor

2. During the test, SISO and MIMO modes have been tested, and only worst case (MIMO) data is listed in the report.

### Shenzhen Anbotek Compliance Laboratory Limited

Address: 1/F., Building D, Sogood Science and Technology Park, Sanwei Community, Hangcheng Street, Bao'an District, Shenzhen, Guangdong, China.  
Tel: (86)0755-26066440 Fax: (86)0755-26014772 Email: service@anbotek.com



Hotline

400-003-0500

www.anbotek.com.cn





TM4 / Band: 5470-5850 MHz / BW: 80 / L							
Frequency (MHz)	Reading (dBuV)	Factor (dB/m)	Result (dBuV/m)	Limit (dBuV/m)	Over limit (dB)	Antenna Pol.	Detector
5460.00	35.71	16.37	52.08	68.20	-16.12	H	Peak
5460.00	37.28	16.37	53.65	68.20	-14.55	V	Peak
5470.00	36.07	16.70	52.77	68.20	-15.43	H	Peak
5470.00	38.23	16.70	54.93	68.20	-13.27	V	Peak
5460.00	26.04	16.37	42.41	54.00	-11.59	H	AVG
5460.00	27.09	16.37	43.46	54.00	-10.54	V	AVG
5470.00	26.79	16.70	43.49	54.00	-10.51	H	AVG
5470.00	27.30	16.70	44.00	54.00	-10.00	V	AVG
TM4 / Band: 5470-5850 MHz / BW: 80 / H							
Frequency (MHz)	Reading (dBuV)	Factor (dB/m)	Result (dBuV/m)	Limit (dBuV/m)	Over limit (dB)	Antenna Pol.	Detector
5850.00	37.85	17.21	55.06	68.20	-13.14	H	Peak
5850.00	38.09	17.21	55.30	68.20	-12.90	V	Peak
5850.00	28.31	17.21	45.52	54.00	-8.48	H	AVG
5850.00	28.45	17.21	45.66	54.00	-8.34	V	AVG

Remark:

1. Result=Reading + Factor
2. During the test, SISO and MIMO modes have been tested, and only worst case (MIMO) data is listed in the report.



## 10. Band edge emissions (Conducted)

Test Requirement:	47 CFR Part 15.407(b)(1) 47 CFR Part 15.407(b)(2)
Test Limit:	For transmitters operating in the 5.15-5.25 GHz band: All emissions outside of the 5.15-5.35 GHz band shall not exceed an e.i.r.p. of -27 dBm/MHz.  For transmitters operating in the 5.25-5.35 GHz band: All emissions outside of the 5.15-5.35 GHz band shall not exceed an e.i.r.p. of -27 dBm/MHz.
Test Method:	Peak emission levels are measured by setting the instrument as follows: RBW = 1 MHz. VBW ≥ [3 × RBW] Detector = peak. Sweep time = auto. Trace mode = max hold.

### 10.1. EUT Operation

Operating Environment:	
Test mode:	<p>1: 802.11a mode: Keep the EUT in continuously transmitting mode with 802.11a modulation type. All data rates has been tested and found the data rate @ 6Mbps is the worst case. Only the data of worst case is recorded in the report.</p> <p>2: 802.11n mode: Keep the EUT in continuously transmitting mode with 802.11n modulation type. All bandwidth and data rates has been tested and found the data rate @ MCS0 is the worst case. Only the data of worst case is recorded in the report.</p> <p>3: 802.11ac mode: Keep the EUT in continuously transmitting mode with 802.11ac modulation type. All bandwidth and data rates has been tested and found the data rate @ MCS0 is the worst case. Only the data of worst case is recorded in the report.</p>

### 10.2. Test Setup

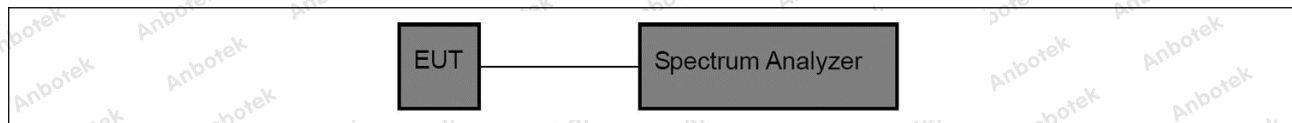

### 10.3. Test Data

Temperature:	24.6 °C	Humidity:	46 %	Atmospheric Pressure:	101 kPa
--------------	---------	-----------	------	-----------------------	---------

Please Refer to Appendix for Details.



## 11. Undesirable emission limits (below 1GHz)

Test Requirement:	47 CFR Part 15.407(b)(9)																								
Test Limit:	<p>Unwanted emissions below 1 GHz must comply with the general field strength limits set forth in § 15.209.</p> <p>Except as provided elsewhere in this subpart, the emissions from an intentional radiator shall not exceed the field strength levels specified in the following table:</p> <table border="1" data-bbox="494 622 1433 958"> <thead> <tr> <th>Frequency (MHz)</th> <th>Field strength (microvolts/meter)</th> <th>Measurement distance (meters)</th> </tr> </thead> <tbody> <tr> <td>0.009-0.490</td> <td>2400/F(kHz)</td> <td>300</td> </tr> <tr> <td>0.490-1.705</td> <td>24000/F(kHz)</td> <td>30</td> </tr> <tr> <td>1.705-30.0</td> <td>30</td> <td>30</td> </tr> <tr> <td>30-88</td> <td>100 **</td> <td>3</td> </tr> <tr> <td>88-216</td> <td>150 **</td> <td>3</td> </tr> <tr> <td>216-960</td> <td>200 **</td> <td>3</td> </tr> <tr> <td>Above 960</td> <td>500</td> <td>3</td> </tr> </tbody> </table> <p>** Except as provided in paragraph (g), fundamental emissions from intentional radiators operating under this section shall not be located in the frequency bands 54-72 MHz, 76-88 MHz, 174-216 MHz or 470-806 MHz. However, operation within these frequency bands is permitted under other sections of this part, e.g., §§ 15.231 and 15.241.</p> <p>In the emission table above, the tighter limit applies at the band edges. The emission limits shown in the above table are based on measurements employing a CISPR quasi-peak detector except for the frequency bands 9–90 kHz, 110–490 kHz and above 1000 MHz. Radiated emission limits in these three bands are based on measurements employing an average detector.</p>	Frequency (MHz)	Field strength (microvolts/meter)	Measurement distance (meters)	0.009-0.490	2400/F(kHz)	300	0.490-1.705	24000/F(kHz)	30	1.705-30.0	30	30	30-88	100 **	3	88-216	150 **	3	216-960	200 **	3	Above 960	500	3
Frequency (MHz)	Field strength (microvolts/meter)	Measurement distance (meters)																							
0.009-0.490	2400/F(kHz)	300																							
0.490-1.705	24000/F(kHz)	30																							
1.705-30.0	30	30																							
30-88	100 **	3																							
88-216	150 **	3																							
216-960	200 **	3																							
Above 960	500	3																							
Test Method:	ANSI C63.10-2020, section 12.7.4, 12.7.5																								
Procedure:	<p>Below 1GHz:</p> <ol style="list-style-type: none"> <li>For below 1GHz, the EUT was placed on the top of a rotating table 0.8 meters above the ground at a 3 meter semi-anechoic chamber. The table was rotated 360 degrees to determine the position of the highest radiation.</li> <li>The EUT was set 3 or 10 meters away from the interference-receiving antenna, which was mounted on the top of a variable-height antenna tower.</li> <li>The antenna height is varied from one meter to four meters above the ground to determine the maximum value of the field strength. Both horizontal and vertical polarizations of the antenna are set to make the measurement.</li> <li>For each suspected emission, the EUT was arranged to its worst case and then the antenna was tuned to heights from 1 meter to 4 meters (for the test frequency of below 30MHz, the antenna was tuned to heights 1 meter) and the rotatable table was turned from 0 degrees to 360 degrees to find the maximum reading.</li> <li>The test-receiver system was set to Peak Detect Function and Specified Bandwidth with Maximum Hold Mode.</li> <li>If the emission level of the EUT in peak mode was 10dB lower than the limit specified, then testing could be stopped and the peak values of the EUT would be reported. Otherwise the emissions that did not have 10dB margin</li> </ol>																								





would be re-tested one by one using quasi-peak method as specified and then reported in a data sheet.

g. Test the EUT in the lowest channel, the middle channel, the Highest channel.

h. The radiation measurements are performed in X, Y, Z axis positioning for Transmitting mode, and found the X axis positioning which it is the worst case.

i. Repeat above procedures until all frequencies measured was complete.

Remark:

1. Level= Read Level+ Cable Loss+ Antenna Factor- Preamp Factor

2. Scan from 9kHz to 30MHz, the disturbance below 30MHz was very low.

The points marked on above plots are the highest emissions could be found when testing, so only above points had been displayed. The amplitude of spurious emissions from the radiator which are attenuated more than 20dB below the limit need not be reported.

3. The disturbance below 1GHz was very low and the harmonics were the highest point could be found when testing, so only the above harmonics had been displayed.

Above 1GHz:

a. For above 1GHz, the EUT was placed on the top of a rotating table 1.5 meters above the ground at a 3 meter fully-anechoic chamber. The table was rotated 360 degrees to determine the position of the highest radiation.

b. The EUT was set 3 meters away from the interference-receiving antenna, which was mounted on the top of a variable-height antenna tower.

c. The antenna height is varied from one meter to four meters above the ground to determine the maximum value of the field strength. Both horizontal and vertical polarizations of the antenna are set to make the measurement.

d. For each suspected emission, the EUT was arranged to its worst case and then the antenna was tuned to heights from 1 meter to 4 meters (for the test frequency of below 30MHz, the antenna was tuned to heights 1 meter) and the rotatable table was turned from 0 degrees to 360 degrees to find the maximum reading.

e. The test-receiver system was set to Peak Detect Function and Specified Bandwidth with Maximum Hold Mode.

f. If the emission level of the EUT in peak mode was 10dB lower than the limit specified, then testing could be stopped and the peak values of the EUT would be reported. Otherwise the emissions that did not have 10dB margin would be re-tested one by one using peak or average method as specified and then reported in a data sheet.

g. Test the EUT in the lowest channel, the middle channel, the Highest channel.

h. The radiation measurements are performed in X, Y, Z axis positioning for Transmitting mode, and found the X axis positioning which it is the worst case.

i. Repeat above procedures until all frequencies measured was complete.

Remark:

1. Level= Read Level+ Cable Loss+ Antenna Factor- Preamp Factor

2. Scan from 18GHz to 40GHz, the disturbance above 18GHz was very low.

The points marked on above plots are the highest emissions could be found when testing, so only above points had been displayed. The amplitude of spurious emissions from the radiator which are attenuated more than 20dB



	<p>below the limit need not be reported.</p> <p>3. As shown in this section, for frequencies above 1GHz, the field strength limits are based on average limits. However, the peak field strength of any emission shall not exceed the maximum permitted average limits specified above by more than 20 dB under any condition of modulation. For the emissions whose peak level is lower than the average limit, only the peak measurement is shown in the report.</p> <p>4. The disturbance above 18GHz were very low and the harmonics were the highest point could be found when testing, so only the above harmonics had been displayed.</p>
--	--

### 11.1. EUT Operation

#### Operating Environment:

Test mode:	<p>1: 802.11a mode: Keep the EUT connect to AC power line and works in continuously transmitting mode with 802.11a modulation type. All data rates has been tested and found the data rate @ 6Mbps is the worst case. Only the data of worst case is recorded in the report.</p> <p>2: 802.11n mode: Keep the EUT connect to AC power line and works in continuously transmitting mode with 802.11n modulation type. All bandwidth and data rates has been tested and found the data rate @ MCS0 is the worst case. Only the data of worst case is recorded in the report.</p> <p>3: 802.11ac mode: Keep the EUT connect to AC power line and works in continuously transmitting mode with 802.11ac modulation type. All bandwidth and data rates has been tested and found the data rate @ MCS0 is the worst case. Only the data of worst case is recorded in the report.</p> <p>4: 802.11ax mode: Keep the EUT connect to AC power line and works in continuously transmitting mode with 802.11ax modulation type. All bandwidth and data rates has been tested and found the data rate @ MCS0 is the worst case. Only the data of worst case is recorded in the report.</p>
------------	--

#### Shenzhen Anbotek Compliance Laboratory Limited

Address: 1/F., Building D, Sogood Science and Technology Park, Sanwei Community, Hangcheng Street, Bao'an District, Shenzhen, Guangdong, China.  
Tel: (86)0755-26066440 Fax: (86)0755-26014772 Email: service@anbotek.com



Hotline  
400-003-0500  
www.anbotek.com.cn



## 11.2. Test Setup

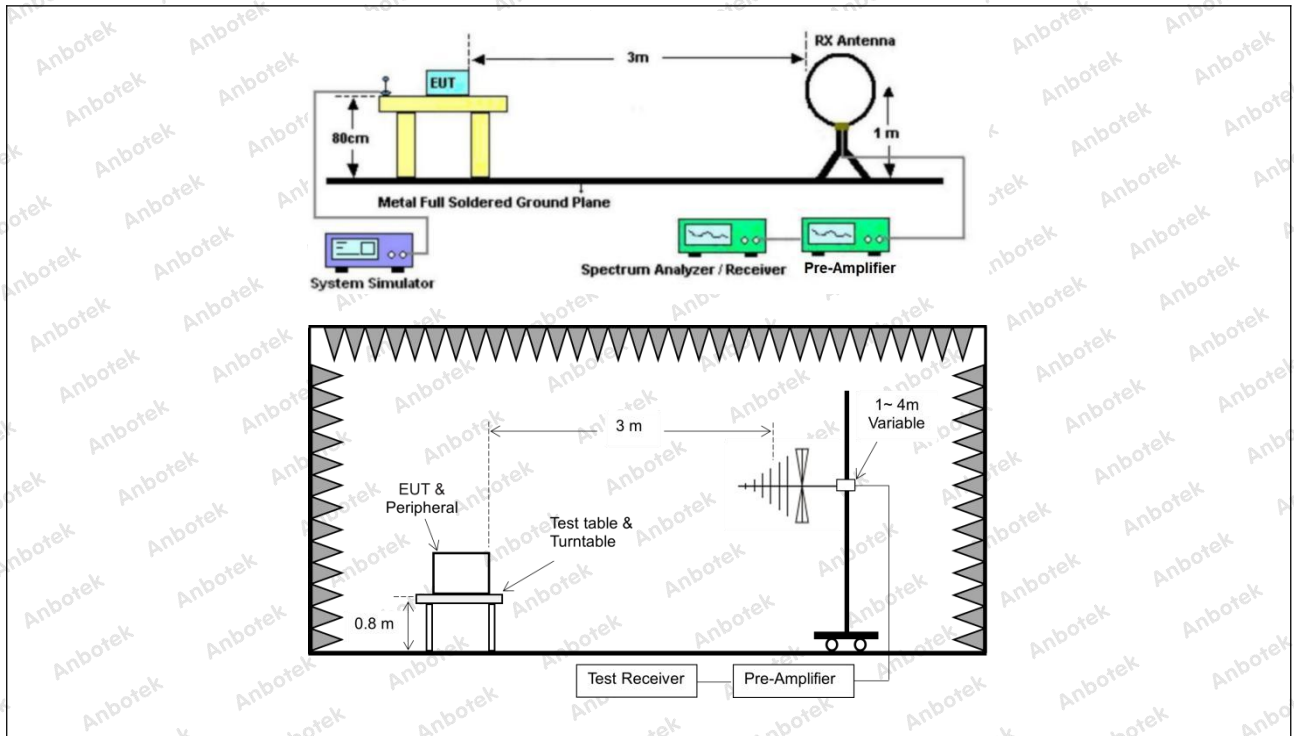



### 11.3. Test Data

The test results of 9kHz-30MHz was attenuated more than 20dB below the permissible limits, so the results don't record in the report.

Temperature:	24.6 °C	Humidity:	46 %	Atmospheric Pressure:	101 kPa
--------------	---------	-----------	------	-----------------------	---------

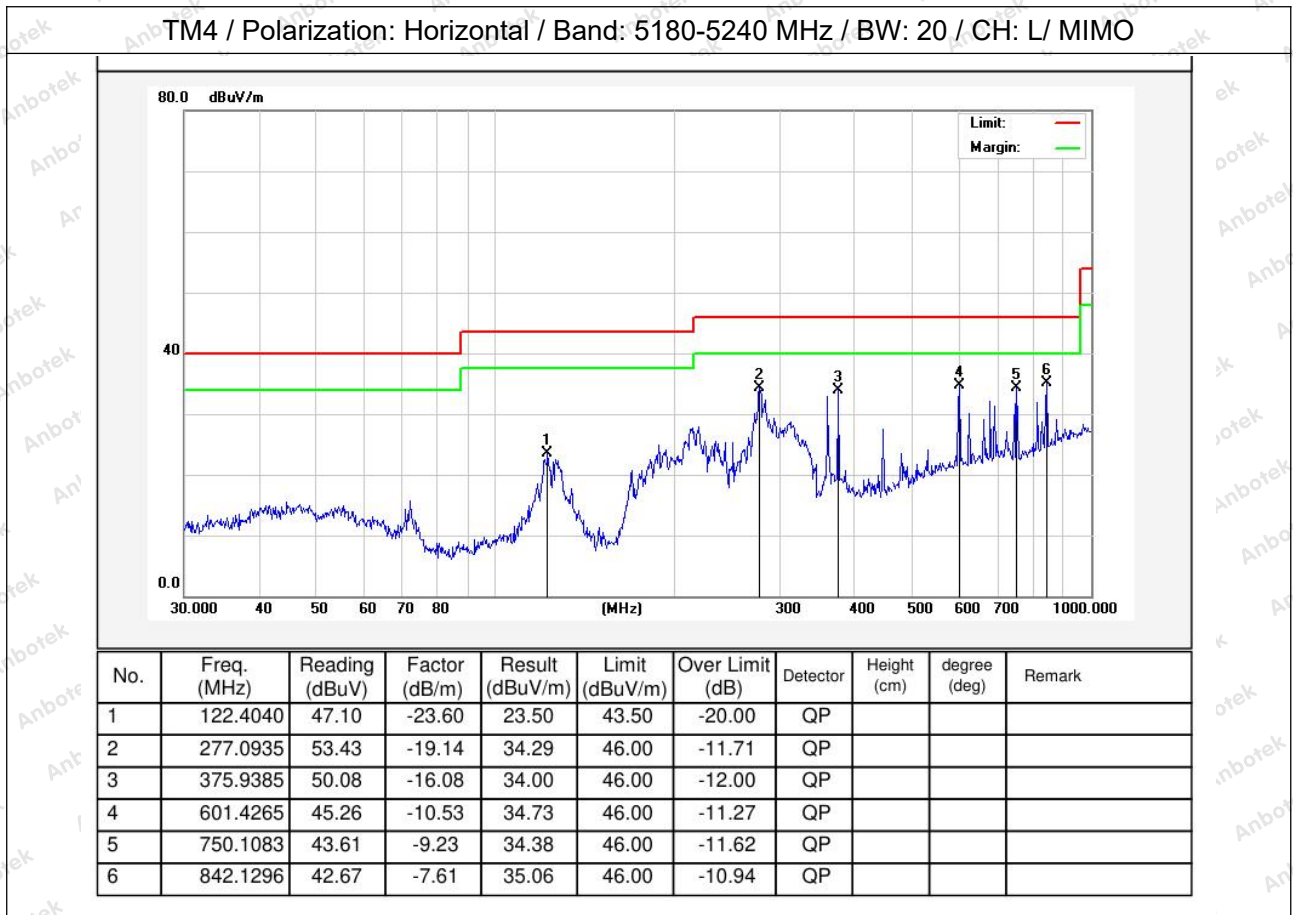

Temperature:	24.6 °C	Humidity:	46 %	Atmospheric Pressure:	101 kPa
--------------	---------	-----------	------	-----------------------	---------

TM4 / Polarization: Vertical / Band: 5180-5240 MHz / BW: 20 / CH: L/ MIMO

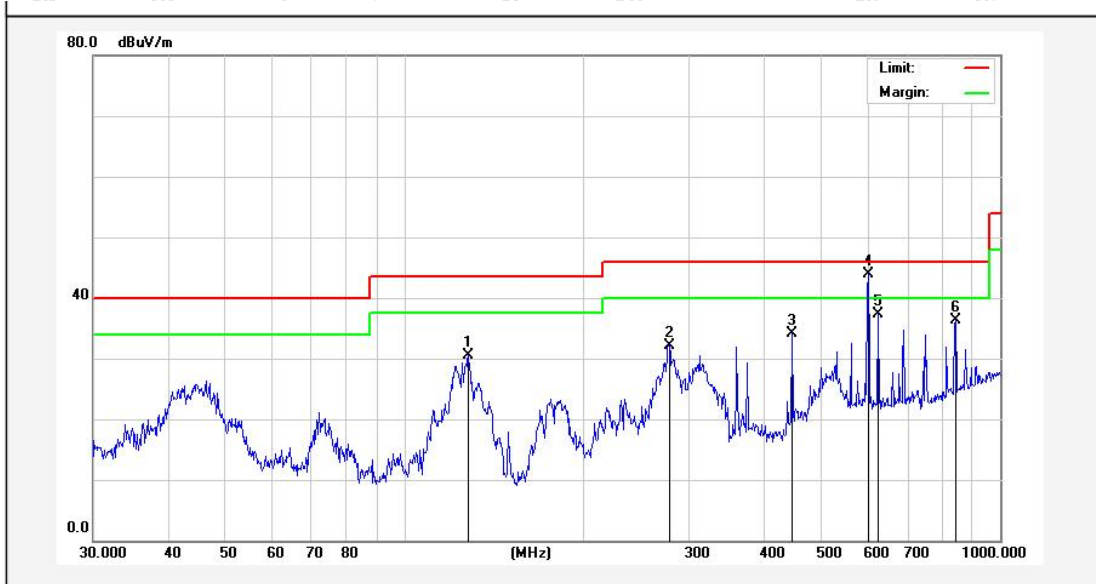

No.	Freq. (MHz)	Reading (dBuV)	Factor (dB/m)	Result (dBuV/m)	Limit (dBuV/m)	Over Limit (dB)	Detector	Height (cm)	degree (deg)	Remark
1	128.1130	51.59	-21.18	30.41	43.50	-13.09	QP			
2	278.0668	49.04	-16.99	32.05	46.00	-13.95	QP			
3	446.4141	47.92	-13.73	34.19	46.00	-11.81	QP			
4	601.4265	54.51	-10.53	43.98	46.00	-2.02	QP			
5	625.0780	47.90	-10.60	37.30	46.00	-8.70	QP			
6	842.1296	43.89	-7.61	36.28	46.00	-9.72	QP			

**Shenzhen Anbotek Compliance Laboratory Limited**

Address: 1/F., Building D, Sogood Science and Technology Park, Sanwei Community, Hangcheng Street, Bao'an District, Shenzhen, Guangdong, China.  
 Tel: (86)0755-26066440 Fax: (86)0755-26014772 Email: service@anbotek.com

Hotline 400-003-0500  
 www.anbotek.com.cn



Temperature:	24.6 °C	Humidity:	46 %	Atmospheric Pressure:	101 kPa
--------------	---------	-----------	------	-----------------------	---------

TM4 / Polarization: Horizontal / Band: 5260-5320 MHz / BW: 20 / CH: L / MIMO

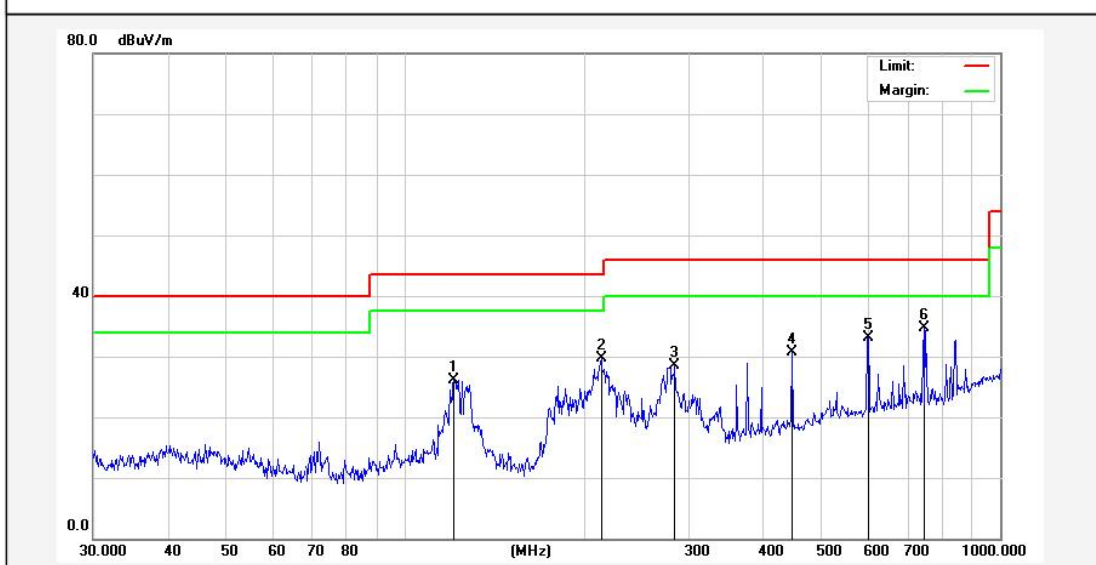

No.	Freq. (MHz)	Reading (dBUV)	Factor (dB/m)	Result (dBUV/m)	Limit (dBUV/m)	Over Limit (dB)	Detector	Height (cm)	degree (deg)	Remark
1	121.1231	49.90	-23.79	26.11	43.50	-17.39	QP			
2	213.7634	51.85	-22.10	29.75	43.50	-13.75	QP			
3	283.9791	47.06	-18.54	28.52	46.00	-17.48	QP			
4	446.4141	46.25	-15.53	30.72	46.00	-15.28	QP			
5	601.4265	43.73	-10.53	33.20	46.00	-12.80	QP			
6	744.8661	43.98	-9.30	34.68	46.00	-11.32	QP			

**Shenzhen Anbotek Compliance Laboratory Limited**

Address: 1/F., Building D, Sogood Science and Technology Park, Sanwei Community, Hangcheng Street, Bao'an District, Shenzhen, Guangdong, China.  
 Tel: (86)0755-26066440 Fax: (86)0755-26014772 Email: service@anbotek.com

Hotline 400-003-0500  
 www.anbotek.com.cn





Temperature:	24.6 °C	Humidity:	46 %	Atmospheric Pressure:	101 kPa
--------------	---------	-----------	------	-----------------------	---------

TM4 / Polarization: Vertical / Band: 5260-5320 MHz / BW: 20 / CH: L/ MIMO

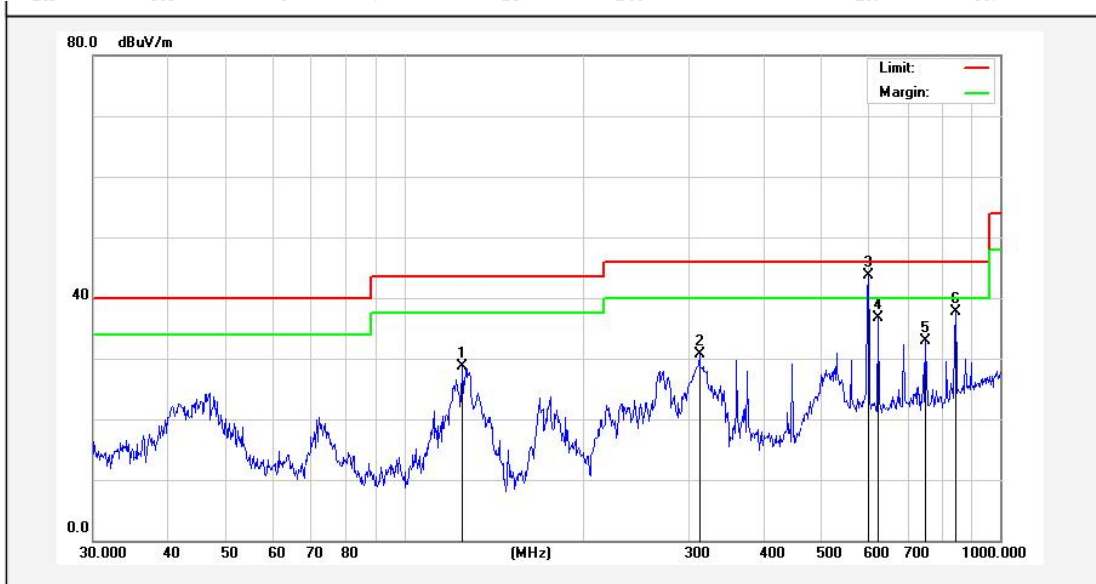

No.	Freq. (MHz)	Reading (dBUV)	Factor (dB/m)	Result (dBUV/m)	Limit (dBUV/m)	Over Limit (dB)	Detector	Height (cm)	degree (deg)	Remark
1	125.0066	49.41	-20.70	28.71	43.50	-14.79	QP			
2	312.1794	46.61	-15.96	30.65	46.00	-15.35	QP			
3	601.4265	54.30	-10.53	43.77	46.00	-2.23	QP			
4	625.0780	47.30	-10.60	36.70	46.00	-9.30	QP			
5	750.1083	42.04	-9.23	32.81	46.00	-13.19	QP			
6	842.1296	45.23	-7.61	37.62	46.00	-8.38	QP			

### Shenzhen Anbotek Compliance Laboratory Limited

Address: 1/F., Building D, Sogood Science and Technology Park, Sanwei Community, Hangcheng Street, Bao'an District, Shenzhen, Guangdong, China.  
 Tel: (86)0755-26066440 Fax: (86)0755-26014772 Email: service@anbotek.com

Hotline 400-003-0500  
 www.anbotek.com.cn



Temperature:	24.6 °C	Humidity:	46 %	Atmospheric Pressure:	101 kPa
--------------	---------	-----------	------	-----------------------	---------

TM4 / Polarization: Horizontal / Band: 5500-5700 MHz / BW: 20 / CH: L / MIMO



No.	Freq. (MHz)	Reading (dBUV)	Factor (dB/m)	Result (dBUV/m)	Limit (dBUV/m)	Over Limit (dB)	Detector	Height (cm)	degree (deg)	Remark
1	122.8340	52.23	-23.53	28.70	43.50	-14.80	QP			
2	213.7633	53.12	-22.10	31.02	43.50	-12.48	QP			
3	277.0935	53.52	-19.14	34.38	46.00	-11.62	QP			
4	360.4476	47.94	-16.02	31.92	46.00	-14.08	QP			
5	601.4265	43.53	-10.53	33.00	46.00	-13.00	QP			
6	750.1082	42.40	-9.23	33.17	46.00	-12.83	QP			

### Shenzhen Anbotek Compliance Laboratory Limited

Address: 1/F., Building D, Sogood Science and Technology Park, Sanwei Community, Hangcheng Street, Bao'an District, Shenzhen, Guangdong, China.  
 Tel: (86)0755-26066440 Fax: (86)0755-26014772 Email: service@anbotek.com

Hotline: 400-003-0500  
 www.anbotek.com.cn



Temperature:	24.6 °C	Humidity:	46 %	Atmospheric Pressure:	101 kPa
--------------	---------	-----------	------	-----------------------	---------

TM4 / Polarization: Vertical / Band: 5500-5700 MHz / BW: 20 / CH: L/ MIMO

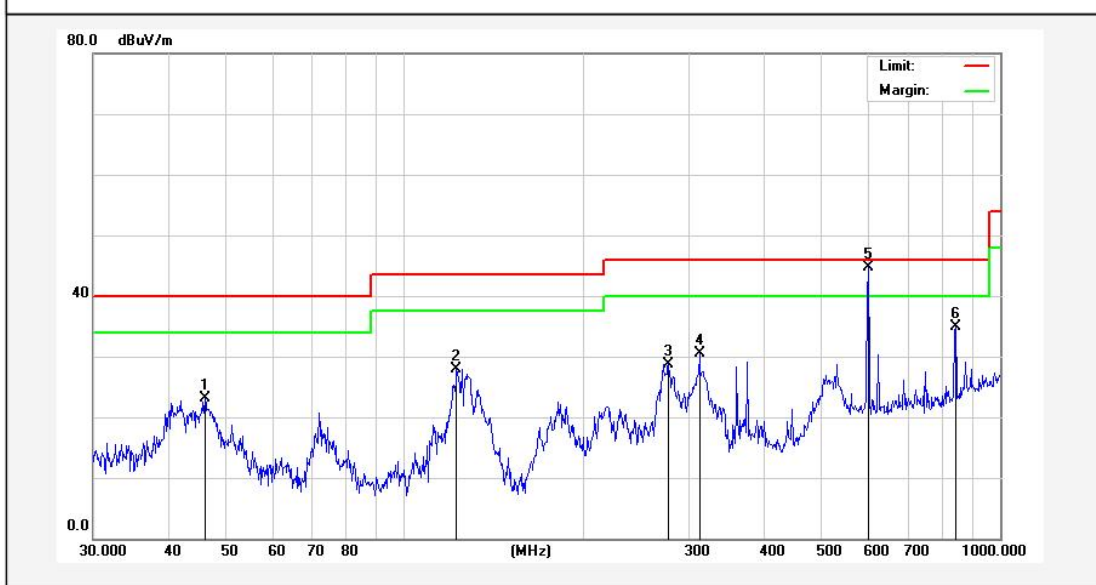

No.	Freq. (MHz)	Reading (dBUV)	Factor (dB/m)	Result (dBUV/m)	Limit (dBUV/m)	Over Limit (dB)	Detector	Height (cm)	degree (deg)	Remark
1	46.1779	38.29	-15.22	23.07	40.00	-16.93	QP			
2	122.4040	48.16	-20.30	27.86	43.50	-15.64	QP			
3	277.0935	45.67	-17.02	28.65	46.00	-17.35	QP			
4	312.1794	46.47	-15.96	30.51	46.00	-15.49	QP			
5	601.4265	55.32	-10.53	44.79	46.00	-1.21	QP			
6	842.1296	42.49	-7.61	34.88	46.00	-11.12	QP			

### Shenzhen Anbotek Compliance Laboratory Limited

Address: 1/F., Building D, Sogood Science and Technology Park, Sanwei Community, Hangcheng Street, Bao'an District, Shenzhen, Guangdong, China.  
 Tel: (86)0755-26066440 Fax: (86)0755-26014772 Email: service@anbotek.com

Hotline: 400-003-0500  
 www.anbotek.com.cn





Temperature:	24.6 °C	Humidity:	46 %	Atmospheric Pressure:	101 kPa
--------------	---------	-----------	------	-----------------------	---------

TM4 / Polarization: Horizontal / Band: 5745-5825 MHz / BW: 20 / CH: L / MIMO

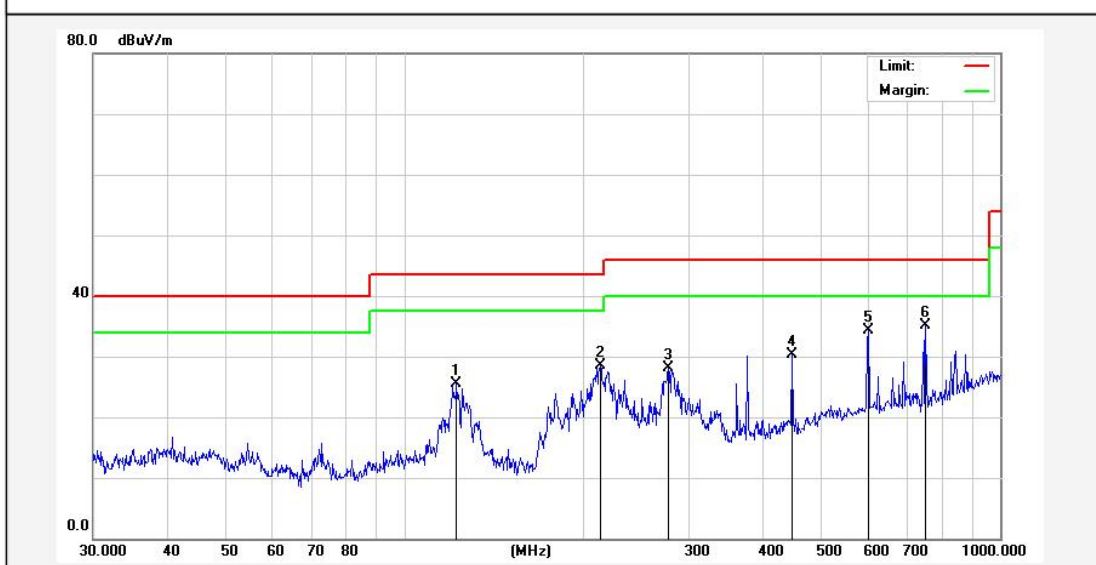

No.	Freq. (MHz)	Reading (dBUV)	Factor (dB/m)	Result (dBUV/m)	Limit (dBUV/m)	Over Limit (dB)	Detector	Height (cm)	degree (deg)	Remark
1	122.4040	49.01	-23.60	25.41	43.50	-18.09	QP			
2	213.0151	50.52	-22.11	28.41	43.50	-15.09	QP			
3	277.0935	47.24	-19.14	28.10	46.00	-17.90	QP			
4	446.4141	45.92	-15.53	30.39	46.00	-15.61	QP			
5	601.4265	44.82	-10.53	34.29	46.00	-11.71	QP			
6	750.1083	44.27	-9.23	35.04	46.00	-10.96	QP			

**Shenzhen Anbotek Compliance Laboratory Limited**

Address: 1/F., Building D, Sogood Science and Technology Park, Sanwei Community, Hangcheng Street, Bao'an District, Shenzhen, Guangdong, China.  
 Tel: (86)0755-26066440 Fax: (86)0755-26014772 Email: service@anbotek.com

Hotline 400-003-0500  
 www.anbotek.com.cn



Temperature:	24.6 °C	Humidity:	46 %	Atmospheric Pressure:	101 kPa
--------------	---------	-----------	------	-----------------------	---------

TM4 / Polarization: Vertical / Band: 5745-5825 MHz / BW: 20 / CH: L/ MIMO

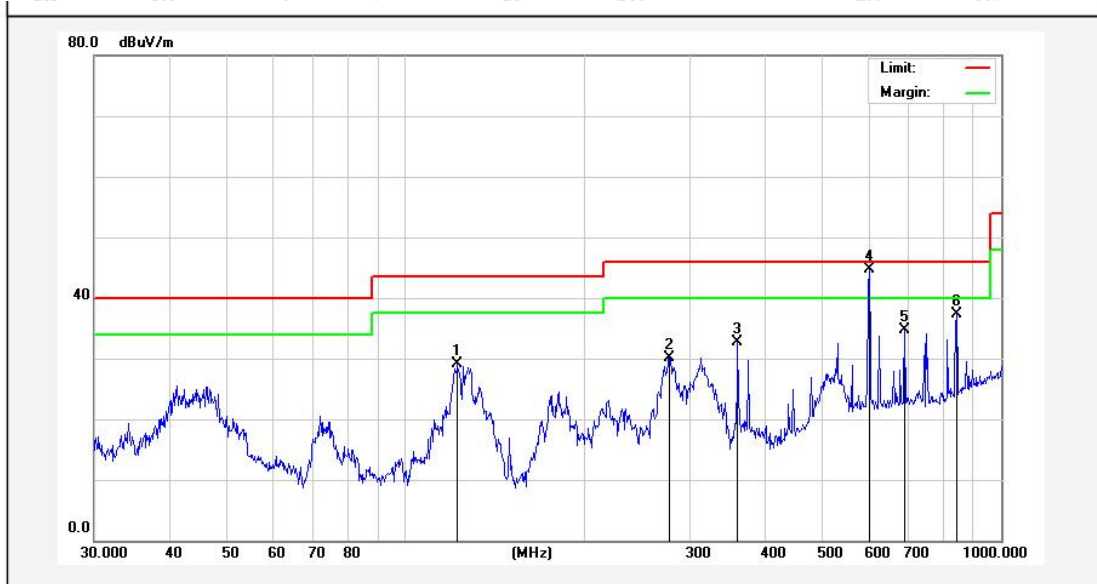

No.	Freq. (MHz)	Reading (dBUV)	Factor (dB/m)	Result (dBUV/m)	Limit (dBUV/m)	Over Limit (dB)	Detector	Height (cm)	degree (deg)	Remark
1	122.4040	49.42	-20.30	29.12	43.50	-14.38	QP			
2	277.0935	47.12	-17.02	30.10	46.00	-15.90	QP			
3	360.4476	47.58	-14.88	32.70	46.00	-13.30	QP			
4	601.4265	55.23	-10.53	44.70	46.00	-1.30	QP			
5	689.5644	44.77	-10.07	34.70	46.00	-11.30	QP			
6	842.1296	45.01	-7.61	37.40	46.00	-8.60	QP			

Note: Only record the worst data (802.11ax(HEW20) MIMO) in the report.



## 12. Undesirable emission limits (above 1GHz)

<p>Test Requirement:</p>	<p>47 CFR Part 15.407(b)(1) 47 CFR Part 15.407(b)(2) 47 CFR Part 15.407(b)(3) 47 CFR Part 15.407(b)(4) 47 CFR Part 15.407(b)(10)</p>																																																																											
<p>Test Limit:</p>	<p>For transmitters operating in the 5.15-5.25 GHz band: All emissions outside of the 5.15-5.35 GHz band shall not exceed an e.i.r.p. of -27 dBm/MHz.</p> <p>For transmitters operating in the 5.25-5.35 GHz band: All emissions outside of the 5.15-5.35 GHz band shall not exceed an e.i.r.p. of -27 dBm/MHz.</p> <p>For transmitters operating in the 5.47-5.725 GHz band: All emissions outside of the 5.47-5.725 GHz band shall not exceed an e.i.r.p. of -27 dBm/MHz.</p> <p>For transmitters operating solely in the 5.725-5.850 GHz band: All emissions shall be limited to a level of -27 dBm/MHz at 75 MHz or more above or below the band edge increasing linearly to 10 dBm/MHz at 25 MHz above or below the band edge, and from 25 MHz above or below the band edge increasing linearly to a level of 15.6 dBm/MHz at 5 MHz above or below the band edge, and from 5 MHz above or below the band edge increasing linearly to a level of 27 dBm/MHz at the band edge.</p> <table border="1" data-bbox="491 1070 1433 1832"> <thead> <tr> <th>MHz</th> <th>MHz</th> <th>MHz</th> <th>GHz</th> </tr> </thead> <tbody> <tr> <td>0.090-0.110</td> <td>16.42-16.423</td> <td>399.9-410</td> <td>4.5-5.15</td> </tr> <tr> <td><sup>1</sup>0.495-0.505</td> <td>16.69475-16.69525</td> <td>608-614</td> <td>5.35-5.46</td> </tr> <tr> <td>2.1735-2.1905</td> <td>16.80425-16.80475</td> <td>960-1240</td> <td>7.25-7.75</td> </tr> <tr> <td>4.125-4.128</td> <td>25.5-25.67</td> <td>1300-1427</td> <td>8.025-8.5</td> </tr> <tr> <td>4.17725-4.17775</td> <td>37.5-38.25</td> <td>1435-1626.5</td> <td>9.0-9.2</td> </tr> <tr> <td>4.20725-4.20775</td> <td>73-74.6</td> <td>1645.5-1646.5</td> <td>9.3-9.5</td> </tr> <tr> <td>6.215-6.218</td> <td>74.8-75.2</td> <td>1660-1710</td> <td>10.6-12.7</td> </tr> <tr> <td>6.26775-6.26825</td> <td>108-121.94</td> <td>1718.8-1722.2</td> <td>13.25-13.4</td> </tr> <tr> <td>6.31175-6.31225</td> <td>123-138</td> <td>2200-2300</td> <td>14.47-14.5</td> </tr> <tr> <td>8.291-8.294</td> <td>149.9-150.05</td> <td>2310-2390</td> <td>15.35-16.2</td> </tr> <tr> <td>8.362-8.366</td> <td>156.52475-156.52525</td> <td>2483.5-2500</td> <td>17.7-21.4</td> </tr> <tr> <td>8.37625-8.38675</td> <td>156.7-156.9</td> <td>2690-2900</td> <td>22.01-23.12</td> </tr> <tr> <td>8.41425-8.41475</td> <td>162.0125-167.17</td> <td>3260-3267</td> <td>23.6-24.0</td> </tr> <tr> <td>12.29-12.293</td> <td>167.72-173.2</td> <td>3332-3339</td> <td>31.2-31.8</td> </tr> <tr> <td>12.51975-12.52025</td> <td>240-285</td> <td>3345.8-3358</td> <td>36.43-36.5</td> </tr> <tr> <td>12.57675-12.57725</td> <td>322-335.4</td> <td>3600-4400</td> <td>(<sup>2</sup>)</td> </tr> <tr> <td>13.36-13.41</td> <td></td> <td></td> <td></td> </tr> </tbody> </table> <p><sup>1</sup>Until February 1, 1999, this restricted band shall be 0.490-0.510 MHz.</p> <p><sup>2</sup>Above 38.6</p>				MHz	MHz	MHz	GHz	0.090-0.110	16.42-16.423	399.9-410	4.5-5.15	<sup>1</sup> 0.495-0.505	16.69475-16.69525	608-614	5.35-5.46	2.1735-2.1905	16.80425-16.80475	960-1240	7.25-7.75	4.125-4.128	25.5-25.67	1300-1427	8.025-8.5	4.17725-4.17775	37.5-38.25	1435-1626.5	9.0-9.2	4.20725-4.20775	73-74.6	1645.5-1646.5	9.3-9.5	6.215-6.218	74.8-75.2	1660-1710	10.6-12.7	6.26775-6.26825	108-121.94	1718.8-1722.2	13.25-13.4	6.31175-6.31225	123-138	2200-2300	14.47-14.5	8.291-8.294	149.9-150.05	2310-2390	15.35-16.2	8.362-8.366	156.52475-156.52525	2483.5-2500	17.7-21.4	8.37625-8.38675	156.7-156.9	2690-2900	22.01-23.12	8.41425-8.41475	162.0125-167.17	3260-3267	23.6-24.0	12.29-12.293	167.72-173.2	3332-3339	31.2-31.8	12.51975-12.52025	240-285	3345.8-3358	36.43-36.5	12.57675-12.57725	322-335.4	3600-4400	( <sup>2</sup> )	13.36-13.41			
MHz	MHz	MHz	GHz																																																																									
0.090-0.110	16.42-16.423	399.9-410	4.5-5.15																																																																									
<sup>1</sup> 0.495-0.505	16.69475-16.69525	608-614	5.35-5.46																																																																									
2.1735-2.1905	16.80425-16.80475	960-1240	7.25-7.75																																																																									
4.125-4.128	25.5-25.67	1300-1427	8.025-8.5																																																																									
4.17725-4.17775	37.5-38.25	1435-1626.5	9.0-9.2																																																																									
4.20725-4.20775	73-74.6	1645.5-1646.5	9.3-9.5																																																																									
6.215-6.218	74.8-75.2	1660-1710	10.6-12.7																																																																									
6.26775-6.26825	108-121.94	1718.8-1722.2	13.25-13.4																																																																									
6.31175-6.31225	123-138	2200-2300	14.47-14.5																																																																									
8.291-8.294	149.9-150.05	2310-2390	15.35-16.2																																																																									
8.362-8.366	156.52475-156.52525	2483.5-2500	17.7-21.4																																																																									
8.37625-8.38675	156.7-156.9	2690-2900	22.01-23.12																																																																									
8.41425-8.41475	162.0125-167.17	3260-3267	23.6-24.0																																																																									
12.29-12.293	167.72-173.2	3332-3339	31.2-31.8																																																																									
12.51975-12.52025	240-285	3345.8-3358	36.43-36.5																																																																									
12.57675-12.57725	322-335.4	3600-4400	( <sup>2</sup> )																																																																									
13.36-13.41																																																																												





	<p>The field strength of emissions appearing within these frequency bands shall not exceed the limits shown in § 15.209. At frequencies equal to or less than 1000 MHz, compliance with the limits in § 15.209 shall be demonstrated using measurement instrumentation employing a CISPR quasi-peak detector. Above 1000 MHz, compliance with the emission limits in § 15.209 shall be demonstrated based on the average value of the measured emissions. The provisions in § 15.35 apply to these measurements.</p> <p>Except as provided elsewhere in this subpart, the emissions from an intentional radiator shall not exceed the field strength levels specified in the following table:</p> <table border="1" data-bbox="491 672 1433 1003"> <thead> <tr> <th>Frequency (MHz)</th> <th>Field strength (microvolts/meter)</th> <th>Measurement distance (meters)</th> </tr> </thead> <tbody> <tr> <td>0.009-0.490</td> <td>2400/F(kHz)</td> <td>300</td> </tr> <tr> <td>0.490-1.705</td> <td>24000/F(kHz)</td> <td>30</td> </tr> <tr> <td>1.705-30.0</td> <td>30</td> <td>30</td> </tr> <tr> <td>30-88</td> <td>100 **</td> <td>3</td> </tr> <tr> <td>88-216</td> <td>150 **</td> <td>3</td> </tr> <tr> <td>216-960</td> <td>200 **</td> <td>3</td> </tr> <tr> <td>Above 960</td> <td>500</td> <td>3</td> </tr> </tbody> </table> <p>** Except as provided in paragraph (g), fundamental emissions from intentional radiators operating under this section shall not be located in the frequency bands 54-72 MHz, 76-88 MHz, 174-216 MHz or 470-806 MHz. However, operation within these frequency bands is permitted under other sections of this part, e.g., §§ 15.231 and 15.241. In the emission table above, the tighter limit applies at the band edges. The emission limits shown in the above table are based on measurements employing a CISPR quasi-peak detector except for the frequency bands 9–90 kHz, 110–490 kHz and above 1000 MHz. Radiated emission limits in these three bands are based on measurements employing an average detector.</p>	Frequency (MHz)	Field strength (microvolts/meter)	Measurement distance (meters)	0.009-0.490	2400/F(kHz)	300	0.490-1.705	24000/F(kHz)	30	1.705-30.0	30	30	30-88	100 **	3	88-216	150 **	3	216-960	200 **	3	Above 960	500	3
Frequency (MHz)	Field strength (microvolts/meter)	Measurement distance (meters)																							
0.009-0.490	2400/F(kHz)	300																							
0.490-1.705	24000/F(kHz)	30																							
1.705-30.0	30	30																							
30-88	100 **	3																							
88-216	150 **	3																							
216-960	200 **	3																							
Above 960	500	3																							
<p>Test Method:</p>	<p>ANSI C63.10-2020, section 12.7.4, 12.7.6, 12.7.7</p>																								
<p>Procedure:</p>	<p>Above 1GHz:</p> <ol style="list-style-type: none"> <li>For above 1GHz, the EUT was placed on the top of a rotating table 1.5 meters above the ground at a 3 meter fully-anechoic chamber. The table was rotated 360 degrees to determine the position of the highest radiation.</li> <li>The EUT was set 3 meters away from the interference-receiving antenna, which was mounted on the top of a variable-height antenna tower.</li> <li>The antenna height is varied from one meter to four meters above the ground to determine the maximum value of the field strength. Both horizontal and vertical polarizations of the antenna are set to make the measurement.</li> <li>For each suspected emission, the EUT was arranged to its worst case and then the antenna was tuned to heights from 1 meter to 4 meters (for the test frequency of below 30MHz, the antenna was tuned to heights 1 meter) and the rotatable table was turned from 0 degrees to 360 degrees to find the maximum reading.</li> <li>The test-receiver system was set to Peak Detect Function and Specified Bandwidth with Maximum Hold Mode.</li> <li>If the emission level of the EUT in peak mode was 10dB lower than the limit specified, then testing could be stopped and the peak values of the EUT</li> </ol>																								



	<p>would be reported. Otherwise the emissions that did not have 10dB margin would be re-tested one by one using peak or average method as specified and then reported in a data sheet.</p> <p>g. Test the EUT in the lowest channel, the middle channel, the Highest channel.</p> <p>h. The radiation measurements are performed in X, Y, Z axis positioning for Transmitting mode, and found the X axis positioning which it is the worst case.</p> <p>i. Repeat above procedures until all frequencies measured was complete.</p> <p>Remark:</p> <ol style="list-style-type: none"> <li>1. Level= Read Level+ Cable Loss+ Antenna Factor- Preamp Factor</li> <li>2. Scan from 18GHz to 40GHz, the disturbance above 18GHz was very low. The points marked on above plots are the highest emissions could be found when testing, so only above points had been displayed. The amplitude of spurious emissions from the radiator which are attenuated more than 20dB below the limit need not be reported.</li> <li>3. As shown in this section, for frequencies above 1GHz, the field strength limits are based on average limits. However, the peak field strength of any emission shall not exceed the maximum permitted average limits specified above by more than 20 dB under any condition of modulation. For the emissions whose peak level is lower than the average limit, only the peak measurement is shown in the report.</li> <li>4. The disturbance above 18GHz were very low and the harmonics were the highest point could be found when testing, so only the above harmonics had been displayed.</li> </ol>
--	---

## 12.1. EUT Operation

Operating Environment:	
	<p>1: 802.11a mode: Keep the EUT connect to AC power line and works in continuously transmitting mode with 802.11a modulation type. All data rates has been tested and found the data rate @ 6Mbps is the worst case. Only the data of worst case is recorded in the report.</p> <p>2: 802.11n mode: Keep the EUT connect to AC power line and works in continuously transmitting mode with 802.11n modulation type. All bandwidth and data rates has been tested and found the data rate @ MCS0 is the worst case. Only the data of worst case is recorded in the report.</p> <p>3: 802.11ac mode: Keep the EUT connect to AC power line and works in continuously transmitting mode with 802.11ac modulation type. All bandwidth and data rates has been tested and found the data rate @ MCS0 is the worst case. Only the data of worst case is recorded in the report.</p> <p>4: 802.11ax mode: Keep the EUT connect to AC power line and works in continuously transmitting mode with 802.11ax modulation type. All bandwidth and data rates has been tested and found the data rate @ MCS0 is the worst case. Only the data of worst case is recorded in the report.</p>
Test mode:	



## 12.2. Test Setup

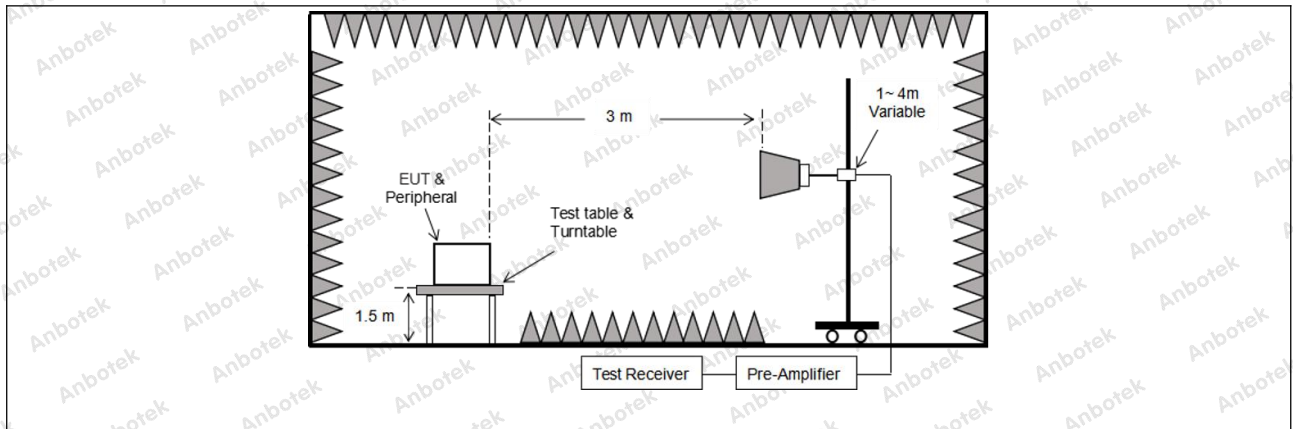

### Shenzhen Anbotek Compliance Laboratory Limited

Address: 1/F., Building D, Sogood Science and Technology Park, Sanwei Community, Hangcheng Street, Bao'an District, Shenzhen, Guangdong, China.  
Tel: (86)0755-26066440 Fax: (86)0755-26014772 Email: service@anbotek.com



Hotline  
400-003-0500  
www.anbotek.com.cn





**12.3. Test Data**

Temperature:	24.6 °C	Humidity:	46 %	Atmospheric Pressure:	101 kPa
--------------	---------	-----------	------	-----------------------	---------

TM4 / Band: 5150-5250 MHz / BW: 20 / CH: L / MIMO							
Frequency (MHz)	Reading (dBuV)	Factor (dB/m)	Result (dBuV/m)	Limit (dBuV/m)	Over limit (dB)	Antenna Pol.	Detector
10360.00	31.45	23.81	55.26	68.20	-12.94	V	Peak
15540.00	32.75	28.68	61.43	68.20	-6.77	V	Peak
10360.00	31.80	23.81	55.61	68.20	-12.59	H	Peak
15540.00	32.85	28.68	61.53	68.20	-6.67	H	Peak
10360.00	20.804	23.81	44.61	54.00	-9.39	V	AVG
15540.00	21.862	28.68	50.54	54.00	-3.46	V	AVG
10360.00	20.988	23.81	44.80	54.00	-9.20	H	AVG
15540.00	21.546	28.68	50.23	54.00	-3.77	H	AVG
TM4 / Band: 5150-5250 MHz / BW: 20 / CH: M / MIMO							
Frequency (MHz)	Reading (dBuV)	Factor (dB/m)	Result (dBuV/m)	Limit (dBuV/m)	Over limit (dB)	Antenna Pol.	Detector
10400.00	30.81	23.81	54.62	68.20	-13.58	V	Peak
15600.00	32.28	29.13	61.41	68.20	-6.79	V	Peak
10400.00	31.29	23.81	55.10	68.20	-13.10	H	Peak
15600.00	32.37	29.13	61.50	68.20	-6.70	H	Peak
10400.00	21.074	23.81	44.88	54.00	-9.12	V	AVG
15600.00	21.982	29.13	51.11	54.00	-2.89	V	AVG
10400.00	20.978	23.81	44.79	54.00	-9.21	H	AVG
15600.00	21.626	29.13	50.76	54.00	-3.24	H	AVG
TM4 / Band: 5150-5250 MHz / BW: 20 / CH: H / MIMO							
Frequency (MHz)	Reading (dBuV)	Factor (dB/m)	Result (dBuV/m)	Limit (dBuV/m)	Over limit (dB)	Antenna Pol.	Detector
10480.00	30.38	23.80	54.18	68.20	-14.02	V	Peak
15720.00	31.76	30.03	61.79	68.20	-6.41	V	Peak
10480.00	30.93	23.80	54.73	68.20	-13.47	H	Peak
15720.00	31.28	30.03	61.31	68.20	-6.89	H	Peak
10480.00	19.74	23.80	43.54	54.00	-10.46	V	AVG
15720.00	20.74	30.03	50.77	54.00	-3.23	V	AVG
10480.00	20.19	23.80	43.99	54.00	-10.01	H	AVG
15720.00	20.42	30.03	50.45	54.00	-3.55	H	AVG

## Remark:

1. Result = Reading + Factor
2. Only the worst case is recorded in the report.

**Shenzhen Anbotek Compliance Laboratory Limited**

Address: 1/F., Building D, Sogood Science and Technology Park, Sanwei Community, Hangcheng Street, Bao'an District, Shenzhen, Guangdong, China.  
Tel: (86)0755-26066440 Fax: (86)0755-26014772 Email: service@anbotek.com



Hotline  
400-003-0500  
www.anbotek.com.cn



TM4 / Band: 5290 MHz / BW: 80 / MIMO							
Frequency (MHz)	Reading (dBuV)	Factor (dB/m)	Result (dBuV/m)	Limit (dBuV/m)	Over limit (dB)	Antenna Pol.	Detector
10580.00	27.67	23.86	51.53	68.20	-16.67	V	Peak
15870.00	28.10	31.16	59.26	68.20	-8.94	V	Peak
10580.00	27.89	23.86	51.75	68.20	-16.45	H	Peak
15870.00	28.13	31.16	59.29	68.20	-8.91	H	Peak
10580.00	17.87	23.86	41.73	54.00	-12.27	V	AVG
15870.00	18.64	31.16	49.80	54.00	-4.20	V	AVG
10580.00	18.16	23.86	42.02	54.00	-11.98	H	AVG
15870.00	18.52	31.16	49.68	54.00	-4.32	H	AVG

**Remark:**

1. Result = Reading + Factor
2. Only the worst case is recorded in the report.



TM4 / Band: 5470-5725 MHz / BW: 20 / CH: L/ MIMO							
Frequency (MHz)	Reading (dBuV)	Factor (dB/m)	Result (dBuV/m)	Limit (dBuV/m)	Over limit (dB)	Antenna Pol.	Detector
11000.00	27.02	24.15	51.17	68.20	-17.03	V	Peak
16500.00	29.16	33.05	62.21	68.20	-5.99	V	Peak
11000.00	28.82	24.15	52.97	68.20	-15.23	H	Peak
16500.00	29.19	33.05	62.24	68.20	-5.96	H	Peak
11000.00	16.729	24.15	40.88	54.00	-13.12	V	AVG
16500.00	18.097	33.05	51.15	54.00	-2.85	V	AVG
11000.00	16.953	24.15	41.10	54.00	-12.90	H	AVG
16500.00	16.791	33.05	49.84	54.00	-4.16	H	AVG
TM4 / Band: 5470-5725 MHz / BW: 20 / CH: M/ MIMO							
Frequency (MHz)	Reading (dBuV)	Factor (dB/m)	Result (dBuV/m)	Limit (dBuV/m)	Over limit (dB)	Antenna Pol.	Detector
11200.000	26.70	23.83	50.53	68.20	-17.67	V	Peak
16800.000	27.33	32.16	59.49	68.20	-8.71	V	Peak
11200.000	27.75	23.83	51.58	68.20	-16.62	H	Peak
16800.000	27.80	32.16	59.96	68.20	-8.24	H	Peak
11200.000	16.979	23.83	40.81	54.00	-13.19	V	AVG
16800.000	18.497	32.16	50.66	54.00	-3.34	V	AVG
11200.000	17.453	23.83	41.28	54.00	-12.72	H	AVG
16800.000	18.651	32.16	50.81	54.00	-3.19	H	AVG
TM4 / Band: 5470-5725 MHz / BW: 20 / CH: H/ MIMO							
Frequency (MHz)	Reading (dBuV)	Factor (dB/m)	Result (dBuV/m)	Limit (dBuV/m)	Over limit (dB)	Antenna Pol.	Detector
11400.000	25.79	23.51	49.30	68.20	-18.90	V	Peak
17100.000	27.22	31.73	58.95	68.20	-9.25	V	Peak
11400.000	26.65	23.51	50.16	68.20	-18.04	H	Peak
17100.000	27.80	31.73	59.53	68.20	-8.67	H	Peak
11400.000	16.36	23.51	39.87	54.00	-14.13	V	AVG
17100.000	17.71	31.73	49.44	54.00	-4.56	V	AVG
11400.000	20.24	23.51	43.75	54.00	-10.25	H	AVG
17100.000	18.44	31.73	50.17	54.00	-3.83	H	AVG

Remark:

1. Result = Reading + Factor

2. Only the worst case is recorded in the report.

**Shenzhen Anbotek Compliance Laboratory Limited**

Address: 1/F., Building D, Sogood Science and Technology Park, Sanwei Community, Hangcheng Street, Bao'an District, Shenzhen, Guangdong, China.  
 Tel: (86)0755-26066440 Fax: (86)0755-26014772 Email: service@anbotek.com



Hotline  
 400-003-0500  
 www.anbotek.com.cn





TM4 / Band: 5775 MHz / BW: 80 / MIMO							
Frequency (MHz)	Reading (dBuV)	Factor (dB/m)	Result (dBuV/m)	Limit (dBuV/m)	Over limit (dB)	Antenna Pol.	Detector
11550.000	30.18	23.40	53.58	68.20	-14.62	V	Peak
17325.000	30.95	32.13	63.08	68.20	-5.12	V	Peak
11550.000	31.21	23.40	54.61	68.20	-13.59	H	Peak
17325.000	31.46	32.13	63.59	68.20	-4.61	H	Peak
11550.000	17.70	23.40	41.10	54.00	-12.90	V	AVG
17325.000	18.29	32.13	50.42	54.00	-3.58	V	AVG
11550.000	17.80	23.40	41.20	54.00	-12.80	H	AVG
17325.000	18.83	32.13	50.96	54.00	-3.04	H	AVG

**Remark:**

1. Result = Reading + Factor
2. Only the worst case is recorded in the report.



**APPENDIX I -- TEST SETUP PHOTOGRAPH**

Please refer to separated files Appendix I -- Test Setup Photograph\_RF

**APPENDIX II -- EXTERNAL PHOTOGRAPH**

Please refer to separated files Appendix II -- External Photograph

**APPENDIX III -- INTERNAL PHOTOGRAPH**

Please refer to separated files Appendix III -- Internal Photograph

----- End of Report -----

**Shenzhen Anbotek Compliance Laboratory Limited**

Address: 1/F., Building D, Sogood Science and Technology Park, Sanwei Community,  
Hangcheng Street, Bao'an District, Shenzhen, Guangdong, China.  
Tel: (86)0755-26066440 Fax: (86)0755-26014772 Email: service@anbotek.com



Hotline  
400-003-0500  
www.anbotek.com.cn

