

# Antenna Specification

## Specifications

### Summary

ITEM	SPEC.	
Model Name	ISM 2.4 GHz	
Center Frequency	2403.65 MHz 2441.65 MHz 2479.65 MHz	3.85 dBi 3.18 dBi 2.80 dBi
MAX. GAIN	3.85 dBi	
Polarization	Horizontal	
Azimuth Beam Pattern	Omni-directional	
Impedance	50 $\Omega$	
Antenna Length	13.1 mm	

### Antenna Photo & Length

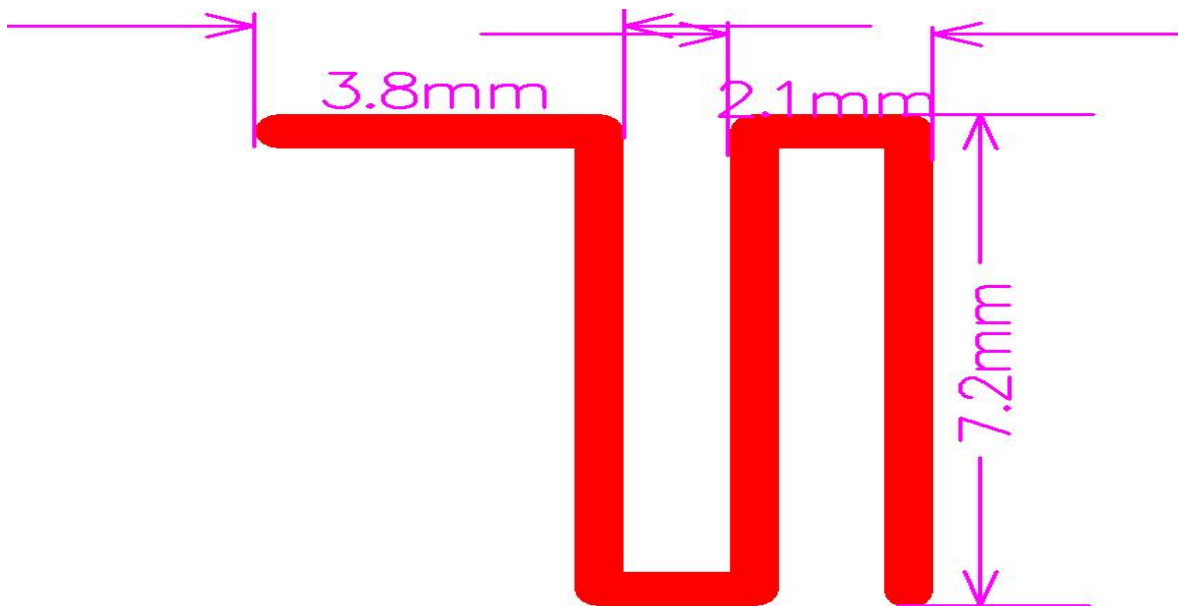

# 1.Main antenna : 2403.65 MHz

## 1.1 Horizontal



Advance Data Technology Corporation

誠信科技股份有限公司

Hwa Ya Lab : No.19, Hwa Ya 2nd RD, Kwei San, Taoyuan, Taiwan, R.O.C.

Taiwan Lab : 13-1 Lane 19, Wu Kuan 3rd St, Kwei San, Taoyuan, Taiwan, R.O.C.

Hsichui Lab: 81-1 Lillackeng, 9th Lla, Wukung Tstex, Chinglin, Hsichui, Taiwan, R.O.C.

http://www.adt.com.tw E-mail: service@adt.com.tw

Tel (886) 318-3232 Fax (886) 318-6050

Tel (886) 327-0910 Fax (886) 327-0892

Tel (886) 593-5343 Fax (886) 593-5342

Brand / Model : IBM 2.4GHz

Remark : E1

Tested by : SHELLY

EUT description :

Location: **RF Chamber3**

Date: **2018/8/16**

Time: **15:20:43**

Temperature (°C): **25**

Humidity (%): **75**

Approved by:

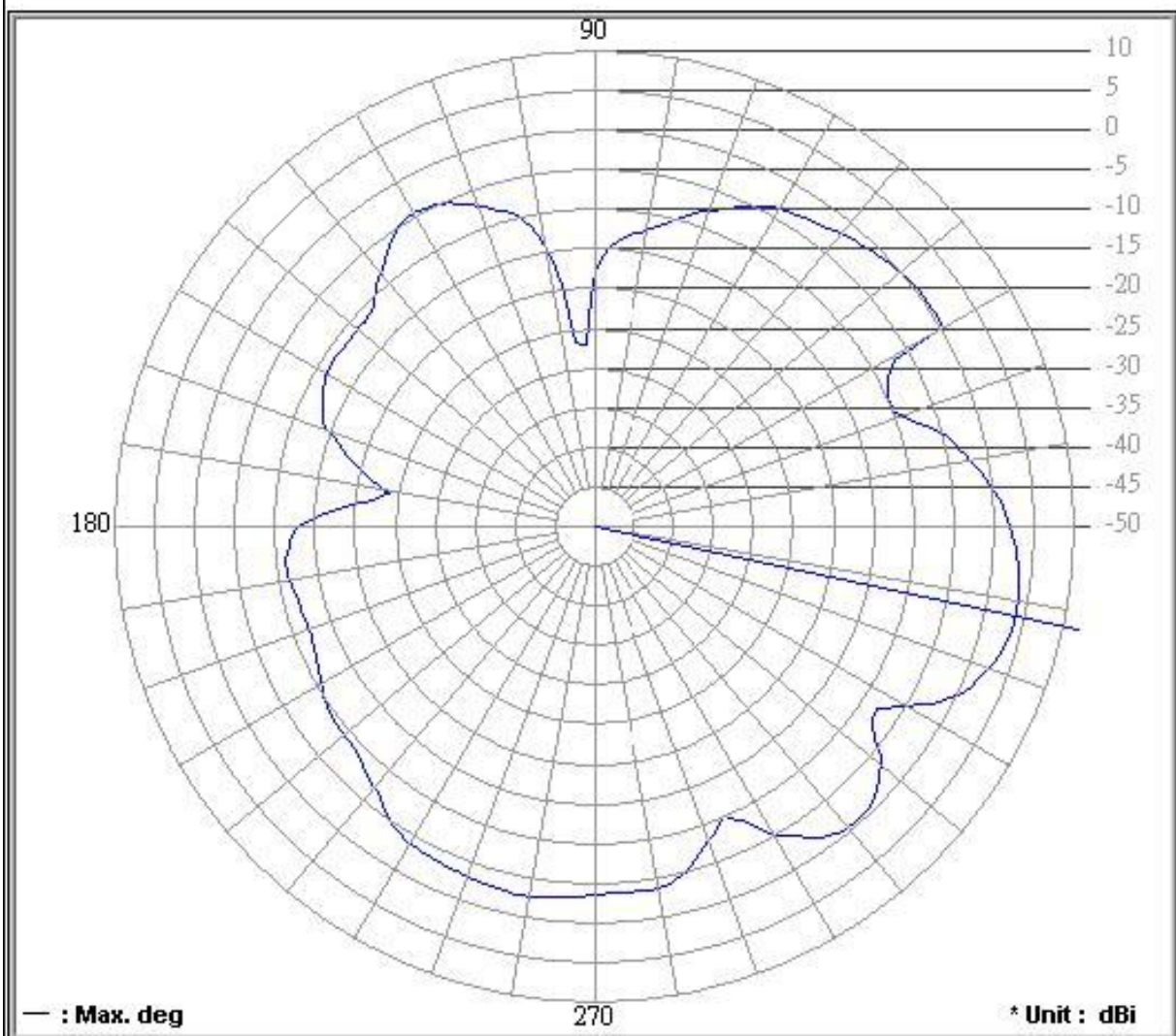

Frequency (MHz) : **2403.65**

Antenna Polarity : **Horizontal**

Average Gain (dB) : **-3.64**

Maximum Gain (dB) :

Maximum Gain (degree) : **346**

Minimum Gain (dB) : **-27.08**

Minimum Gain (degree) : **93**

C:\Antenna Pattern V5.0\Graph\0818\08180019.png

## 1.2 Vertical



Advance Data Technology Corporation

誠信科技股份有限公司

http://www.adt.com.tw E-mail: service@adt.com.tw

Hwa Ya Lab : No.19, Hwa Ya 2nd RD, Kieik iai, Taoyuan, Taiwan, R.O.C.

Tel (886) 318-3232 Fax (886) 318-6050

Tayuan Lab : 13-1 Lane 19, Wei Siao 3rd St, Kieik iai, Taoyuan, Taiwan, R.O.C.

Tel (886) 327-0910 Fax (886) 327-0892

Hsichih Lab: 81-1 Lidaokeng, 9th Lin, Wuling Tzuen, Ciktunglin, Hsichih, Taiwan, R.O.C.

Tel (886) 593-5343 Fax (886) 593-5342

Brand / Model : IBM 2.4GHz

Remark : E1

Tested by : SHELLY

EUT description :

Location: **RF Chamber3**

Date: **2018/8/16**

Time: **15:34:49**

Temperatuer (°C): **25**

Humidity (%): **75**

Approved by:

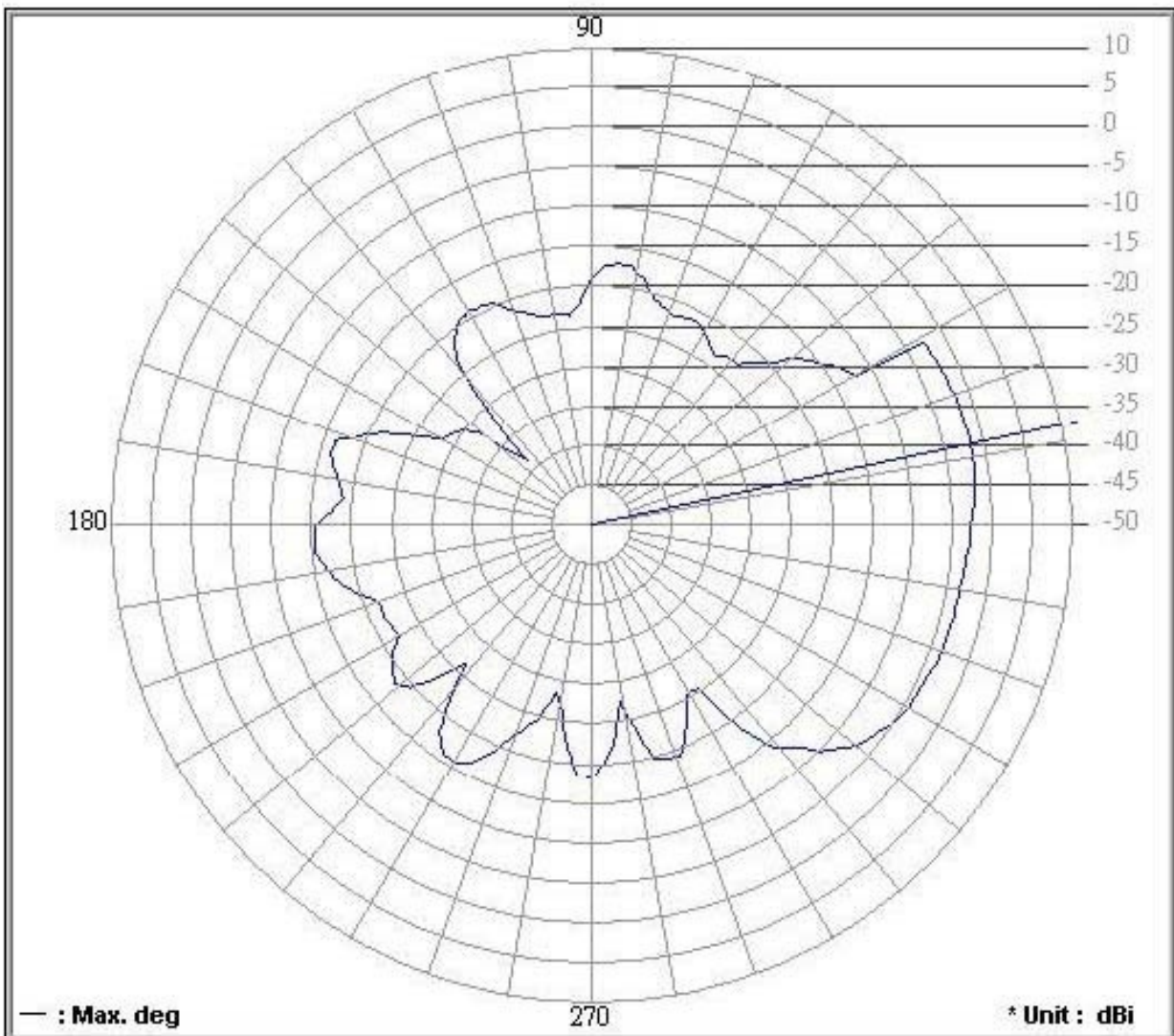

Frequency (MHz) : **2403.65**

Antenna Polarity : **Vertical**

Average Gain (dB) : **-9.57**

Maximum Gain (dB) :

Maximum Gain (degree) : **12**

Minimum Gain (dB) : **-38.76**

Minimum Gain (degree) : **135**

C:\Antenna Pattern V5.0\Graph\0818\08180024.png



## 2.Main antenna : 2441.65 MHz

### 2.1 Horizontal



Advance Data Technology Corporation

誠信科技股份有限公司

Hwa Ya Lab : No.19, Hwa Ya 2nd RD, Kwei Kwei, Taoyuan, Taiwan, R.O.C.

http://www.adt.com.tw E-mail: service@adt.com.tw

Taipei Lab : 13-1 Lane 19, Wei Sikai 3rd St, Kwei Kwei, Taoyuan, Taiwan, R.O.C.

Tel (886) 318-3232 Fax (886) 318-6050

Hsichui Lab: 81-1 Lufeng Rd, 9th Fl, Wuling Tzwei, Chungli, Hsichui, Taiwan, R.O.C.

Tel (886) 327-0910 Fax (886) 327-0892

Tel (886) 593-5343 Fax (886) 593-5342

Brand / Model : IBM 2.4GHz

Remark : E1

Tested by : SHELLY

EUT description :

Location: **RF Chamber3**

Date: **2018/8/16**

Time: **15:23:51**

Temperature (°C): **25**

Humidity (%): **75**

Approved by:

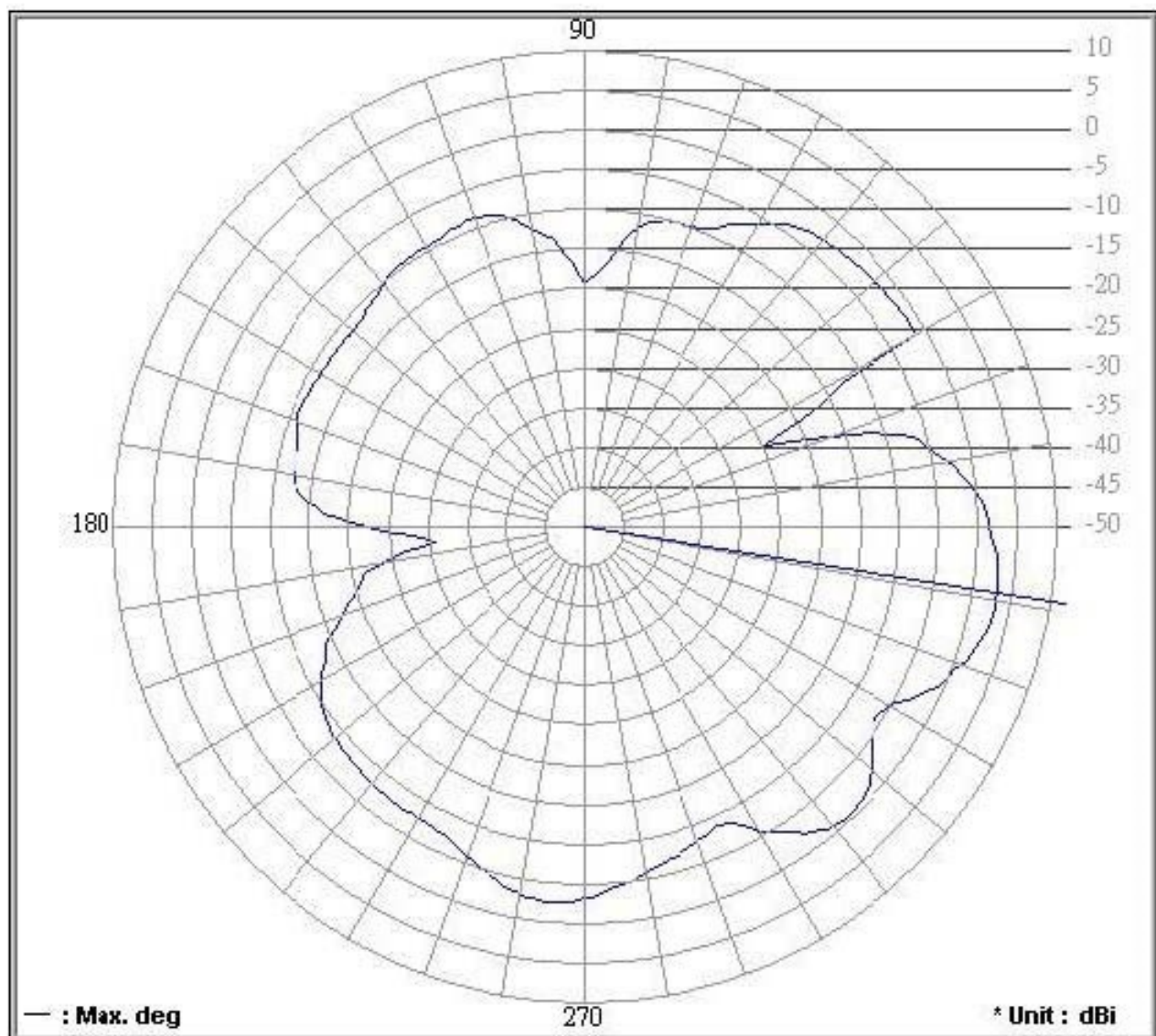

Frequency (MHz): **2441.65** Antenna Polarity: **Horizontal** Average Gain (dB): **-4.64**

Maximum Gain (dB): **-30.92** Maximum Gain (degree): **186**

Minimum Gain (dB): **-30.92** Minimum Gain (degree): **186**

C:\Antenna Pattern V5.0\Graph\0818\08180020.png

## 2.2 Vertical



Advance Data Technology Corporation

誠信科技股份有限公司

http://www.adt.com.tw E-mail: se.ulbe@adt.com.tw

Hwa Ya Lab: No.19, Hwa Ya 2nd RD, Kieik kai, Taoyuan, Taiwan, R.O.C.

Tel (886) 318-3232 Fax (886) 318-5050

Taipei Lab: 13-1 Lane 15, Wei Shai 3rd St, Kieik kai, Taoyuan, Taiwan, R.O.C.

Tel (886) 327-0910 Fax (886) 327-0892

Hsichui Lab: 81-1 Lailackg, 9th Ln, Wuling Tzuei, Chinglin, Hsichui, Taiwan, R.O.C.

Tel (886) 593-5343 Fax (886) 593-5342

Brand / Model : IBM 2.4GHz

Remark : E1

Tested by : SHELLY

EUT description :

Location: **RF Chamber3**

Date: **2018/8/16**

Time: **15:32:20**

Temperature (°C): **25**

Humidity (%): **75**

Approved by:

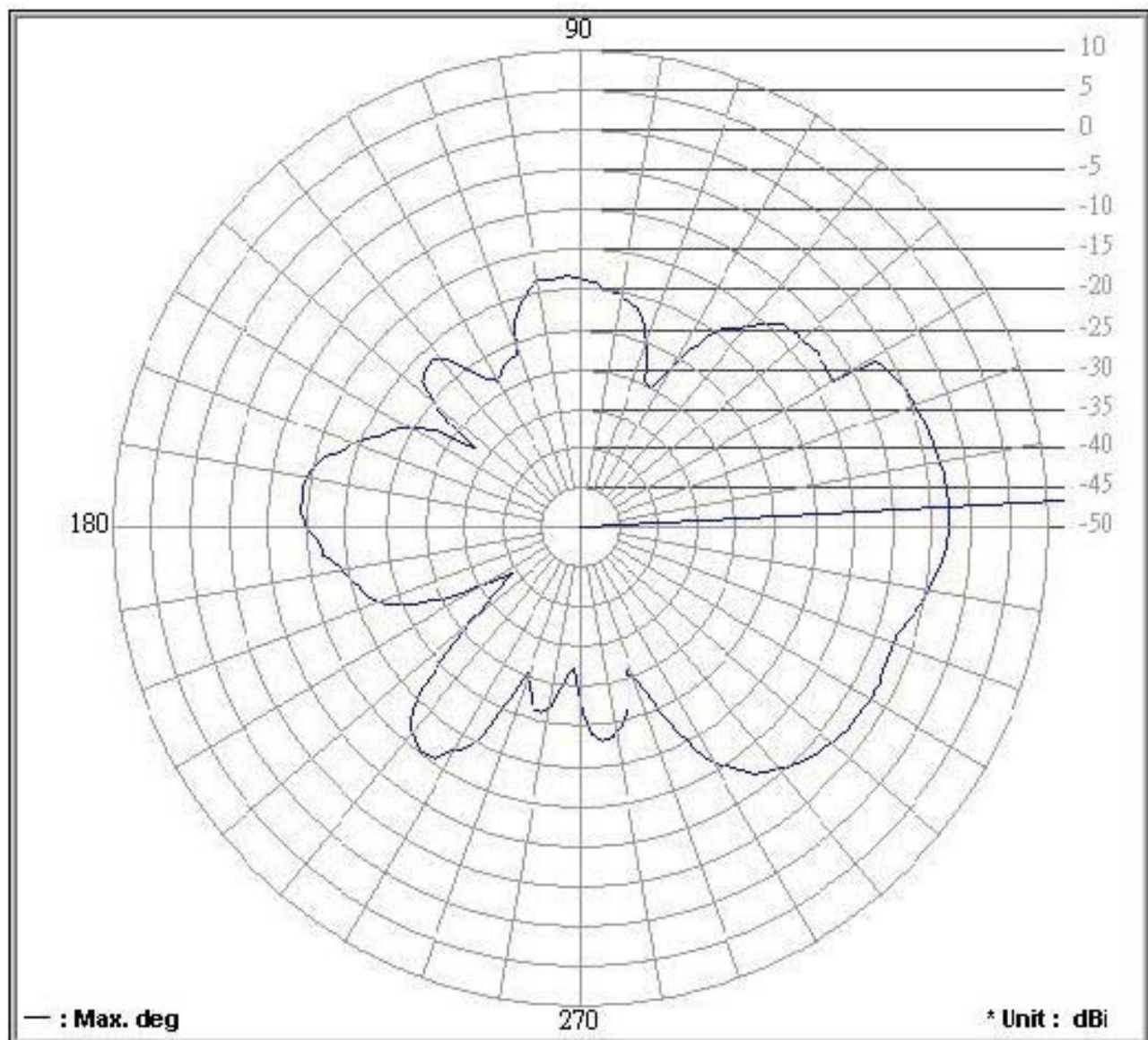

Frequency (MHz) : **2441.65**

Antenna Polarity : **Vertical**

Average Gain (dB) : **-11.06**

Maximum Gain (dB) :

Maximum Gain (degree) : **3**

Minimum Gain (dB) : **-39.35**

Minimum Gain (degree) : **213**

C:\Antenna Pattern V5.0\Graph\0818\08180023.png



### 3.Main antenna : 2479.65 MHz

#### 3.1 Horizontal



Advance Data Technology Corporation

誠信科技股份有限公司

Hwa Ya Lab : No.19, Hwa Ya 2nd RD, Kieik iai, Taoyuan, Taiwan, R.O.C.

http://www.adt.com.tw/ E-mail: service@adt.com.tw

Taipei Lab : 13-1 Lane 19, Wei Siak 3rd St, Kieik iai, Taoyuan, Taiwan, R.O.C.

Tel (03) 318-3232 Fax (03) 318-5050

Hsichih Lab: 81-1 Lillackeng, 9th Lin, Wuling Tseia, Chinglin, Hsichih, Taiwan, R.O.C.

Tel (03) 327-0910 Fax (03) 327-0892

Tel (03) 693-6343 Fax (03) 693-6342

Brand / Model : IBM 2.4GHz

Remark : E1

Tested by : SHELLY

EUT description :

Location: **RF Chamber3**

Date: **2018/8/16**

Time: **15:29:55**

Temperatuer (°C): **25**

Humidity (%): **75**

Approved by:

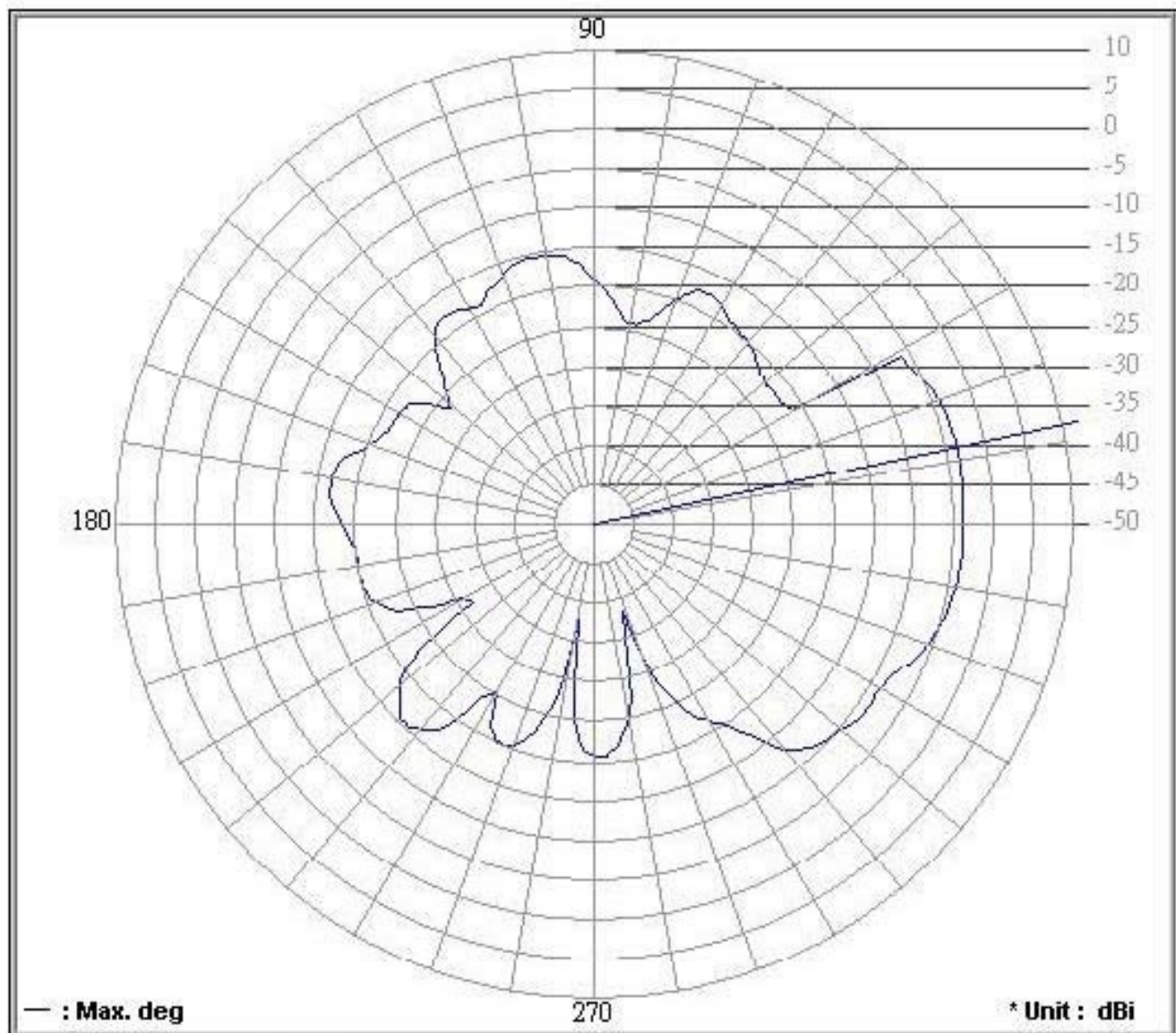

Frequency (MHz) : **2479.65**

Antenna Polarity : **Vertical**

Average Gain (dB) : **-11.34**

Maximum Gain (dB) :

Maximum Gain (degree) : **12**

Minimum Gain (dB) : **-38.33**

Minimum Gain (degree) : **288**

C:\Antenna Pattern V5.0\Graph\0818\08180022.png

### 3.2 Vertical



Advance Data Technology Corporation

誠信科技股份有限公司

http://www.adt.com.tw E-mail: service@adt.com.tw

Hwa Ya Lab : No.19, Hwa Ya 2nd RD, Kieiklai, Taoyuan, Taiwan, R.O.C.

Tel (886) 318-3232 Fax (886) 318-5050

Tayuan Lab : 13-1 Lane 19, Wai Shai 3rd St, Kieiklai, Taoyuan, Taiwan, R.O.C.

Tel (886) 327-0910 Fax (886) 327-0892

Heliokai Lab: 81-1 Lilbokaig, 9th Lla, Wukung Tones, Cilingli, Heliokai, Taiwan, R.O.C.

Tel (886) 603 6343 Fax (886) 603 6342

Brand / Model : IBM 2.4GHz

Remark : E1

Tested by : SHELLY

EUT description :

Location: **RF Chamber3**

Date: **2018/8/16**

Time: **15:26:19**

Temperatuer (°C): **25**

Humidity (%): **75**

Approved by:

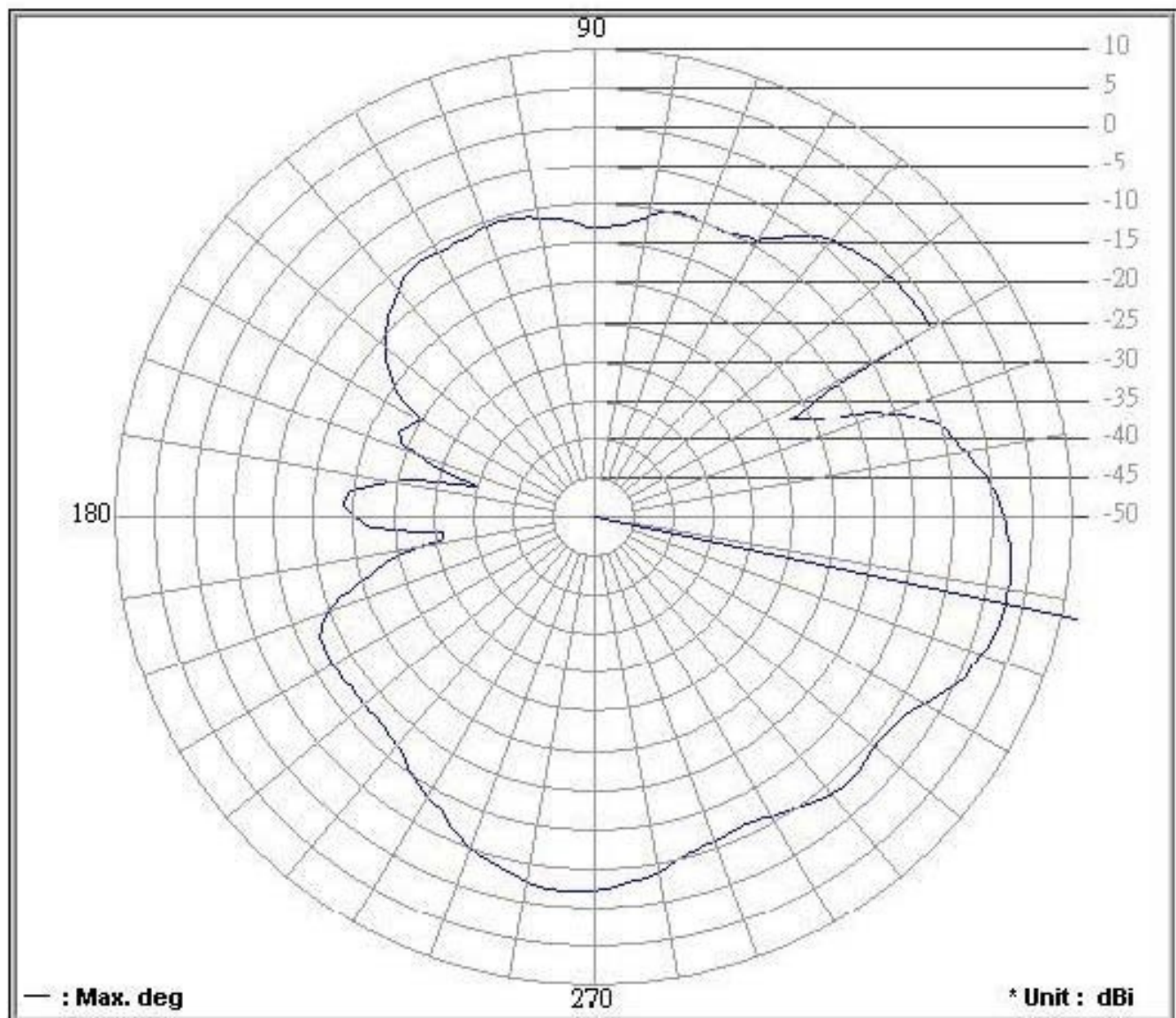

Frequency (MHz) : **2479.65**

Antenna Polarity : **Horizontal**

Average Gain (dB) : **-4.84**

Maximum Gain (dB) :

Maximum Gain (degree) : **348**

Minimum Gain (dB) : **-34.80**

Minimum Gain (degree) : **165**

C:\Antenna Pattern V5.0\Graph\0818\08180021.png

#### 4. Result

<b>Center Frequency</b>		<b>Maximum Ant Gain</b>
<b>2403.65 MHz</b>	<b>H</b>	<b>3.85 dBi</b>
	<b>V</b>	<b>-1.54 dBi</b>
<b>2441.65 MHz</b>	<b>H</b>	<b>3.18 dBi</b>
	<b>V</b>	<b>-2.58 dBi</b>
<b>2479.65 MHz</b>	<b>H</b>	<b>2.80 dBi</b>
	<b>V</b>	<b>-3.47 dBi</b>