

6L SMART TOP FILLER AIR HUMIDIFIER

PE-AH038

User Manual



# Instructions

The appliance is not to be used by persons (including children) with reduced physical, sensory or mental capabilities, or lack of experience and knowledge, unless they have been given supervision or instruction.

Children being supervised not to play with the appliance.

This appliance can be used by children aged from 8 years and above and persons with reduced physical, sensory or mental capabilities or lack of experience and knowledge if they have been given supervision or instruction concerning use of the appliance in a safe way and understand the hazards involved.

Children shall not play with the appliance.

Cleaning and user maintenance shall not be made by children without supervision.

If the supply cord is damaged, it must be replaced by the manufacturer of its service agent or a similarly qualified person in order to avoid a hazard.

- Be aware that high humidity levels may encourage the growth of biological organisms in the environment.
- Do not permit the area around the humidifier to become damp or wet. If dampness occurs, turn the output of the humidifier down. If the humidifier output volume cannot be turned down, use the humidifier intermittently. Do not allow absorbent materials, such as carpeting, curtains, drapes, or tablecloths, to become damp.
- Unplug the appliance during filling and cleaning.
- Never leave water in the reservoir when the appliance is not in use.
- Empty and clean the humidifier before storage. Clean the humidifier before next use.

Warning: Micro-organisms that may be present in the water or in the environment where the appliance is used or stored, can grow in the water reservoir and be blown in the air causing very serious health risks when the water is not renewed and the tank is not cleaned properly every 3 days.

## Correct Disposal of This Product (Waste Electrical & Electronic Equipment) (Applicable in countries with separate collection systems)



This marking on the product, accessories or literature indicates that the product and its electronic accessories should not be disposed of with other household waste at the end of their working life. To prevent possible harm to the environment or human health from uncontrolled waste disposal, please separate these items from other types of waste and recycle them responsibly to promote the sustainable reuse of material resources. Household users should contact either the retailer where they purchased this product, or their local government office, for details of where and how they can take these items for environmentally safe recycling. Business users should contact their supplier and check the terms and conditions of the purchase contract. This product and its electronic accessories should not be mixed with other commercial wastes for disposal.

# Ultrasonic Aroma Humidifier

This decorative and unique ultrasonic aroma humidifier generates cooling mist to moisture the air and prevent dry with timer, night light and humidifying function. It can be used in the living room, bedroom, office and etc.

## **FEATURES:**

**Humidifier** - Moisturize and refresh the air we breathe. This feature is important as it humidifies the hot and dry air all the year.

**Aromatherapy** - Enjoy the ultimate aromatherapy experience from this device using your favorite fragrance without any heating elements making this diffuser safe to use. The advanced ultrasonic technology used, produces vibrations at high frequency turning the water into mist creating a soothing and therapeutic atmosphere.

**Ionizer** - Produces “happy feeling” negative ions which help to lift your mood, strengthen the immune system and release stress. Negative ions have several other benefits to respiration systems and general well-being.

**Night light** - This feature provides other options to set atmosphere to enhance your mood. The soft color changing night light creates a wonderful tranquil ambience to enjoy.

**Timer** - Set times in 1-12 hours and choose the timer you like. The unit will stop automatically when the time runs out. This function brings you more freedom, convenience and efficiency to your life and work.

**Mist control** - Set high and low mist according to the moisture around you.

**Constant humidity mode** – Set a humidity level between 30-75% and let the humidifier hold it for you. When the ambient humidity exceeds the set value, the humidifier will stop working.

## SPECIFICATIONS:

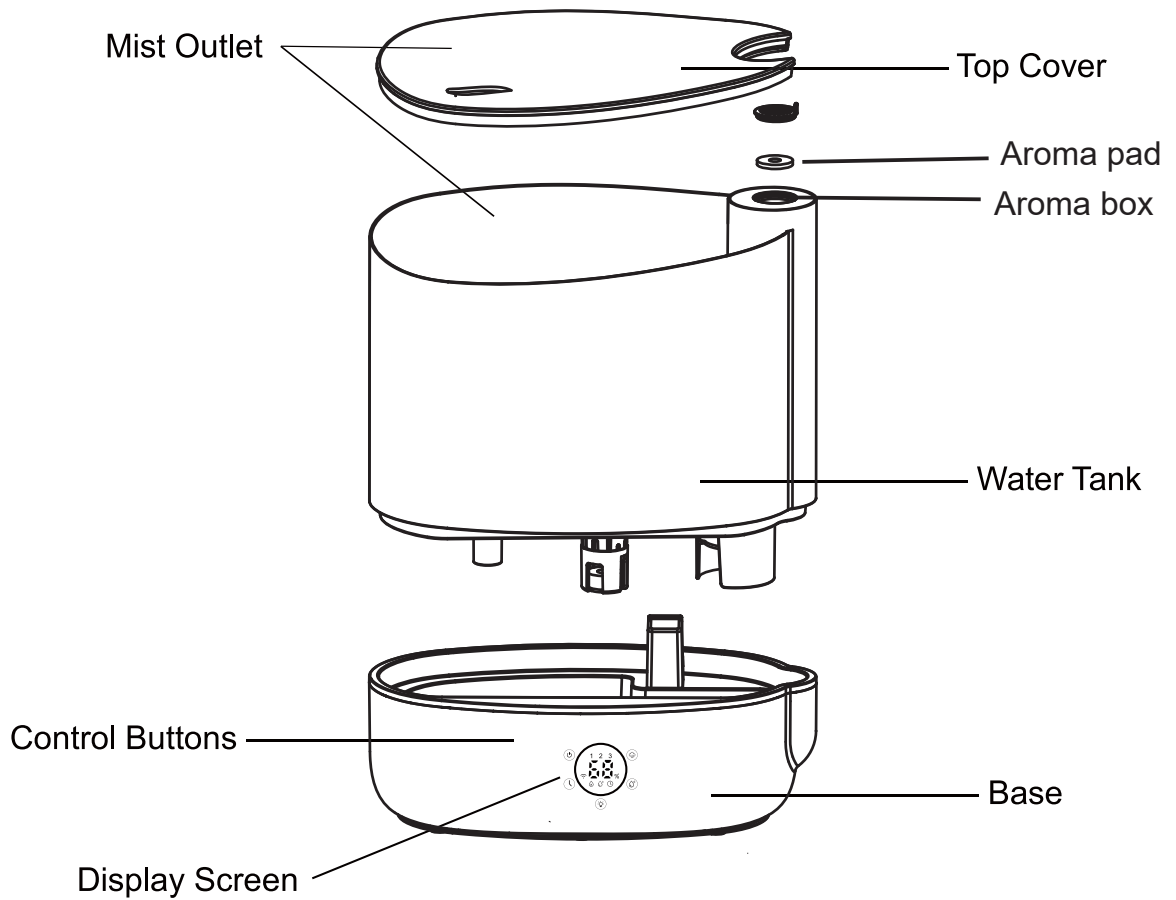

## TECHNICAL DATA:

- Product name: 6L SMART TOP FILLER AIR HUMIDIFIER
- Model No.: PE-AH038
- Input voltage: AC 120V 60Hz
- Rated power: 25W
- Water tank volume: 6L
- Dimension:  $\phi$  312.5\*192\*336.4mm

## **IMPORTANT NOTES:**

1. Place the device on a flat surface, about 60cm away from the floor and 10cm away from the wall. Do not place it directly on a wooden furniture without waterproof treatment, in case the water overflow and damage your furniture.
2. Please make sure that the humidifier is off and disconnected from the electrical outlet while installing or cleaning.
3. Please keep the humidifier out of reach of your children and pets.
4. Please keep the humidifier in a clear space to allow the mist to spread freely and away from any appliances, especially those sensitive to water, to avoid unnecessary accidents.
5. Please pour the water out and clean the water tank when humidifier is not in use.
6. Please do not disassemble this product at will in case of circuit damage or danger to personnel.
7. Please add water to the water tank instead of the base. Make sure there are no small objects in the tank, otherwise it may cause the drain to fail to close and leak water.
8. Please add essential oil from the water tank and don't not add too much.
9. Please clean the water tank and the inside of the base regularly.

**Do not attempt to fill the water into the humidifier from the mist outlet**

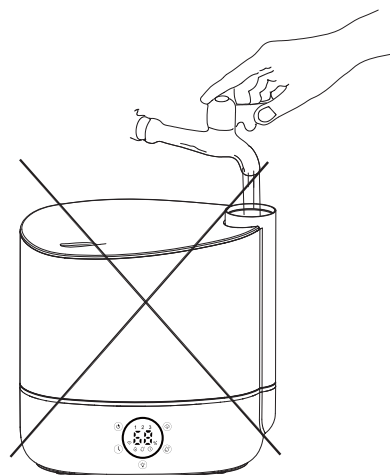

# OPERATING INSTRUCTIONS:

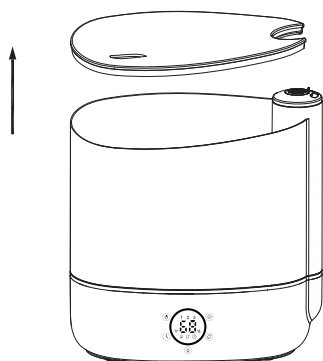

**Step 1:** Take off the top cover

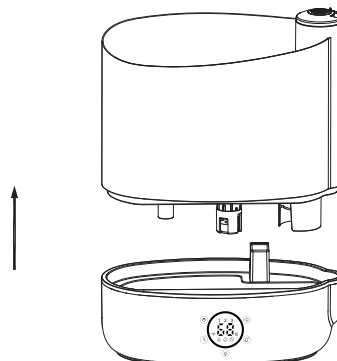

**Step 2:** Take off the water tank

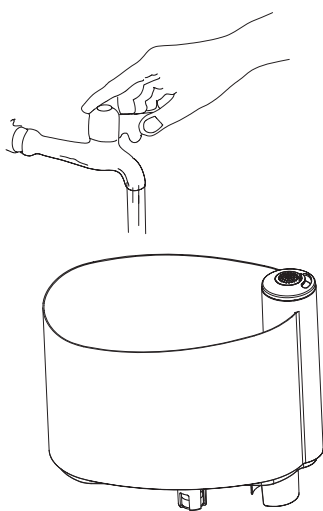

**Step 3:** Fill the tank with water

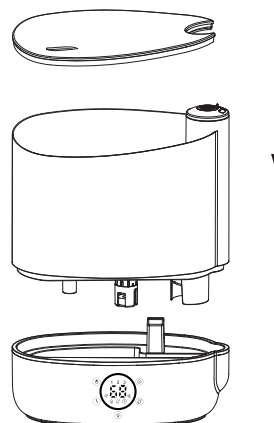

**Step 4:** Place the water tank

Lift off the aroma cap.

Put 8-10 drops of essential oil on the aroma pad.

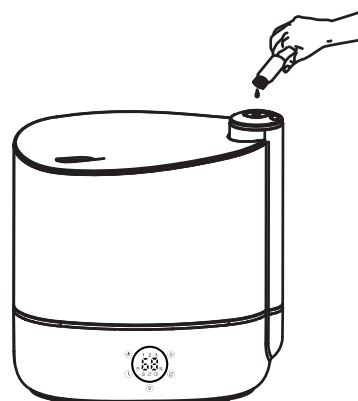

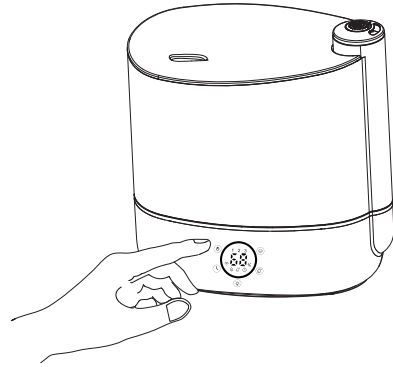
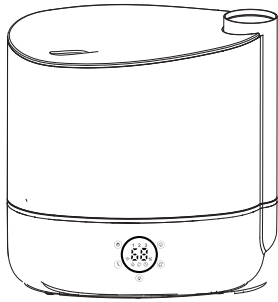



**Step 5:** Connect power with plug

Power  : Control the power.  
- 1 touch: Turn on the humidifier.  
- 2 touch: Turn off the mist.

Mist  - 1 touch: Medium mist mode on.  
- 2 touch: High mist mode on.  
- 3 touch: Low mist mode on.

If current mist is higher than 85%, the mist will be turn off but fan will keep working.  
Mist will restart when current mist level is lower than 80%.

Timer  : Set timer (1-12H).  
- 1 touch: "0" flickeringly display on the screen.  
- 2 touch: Turn "01" and show the clock pattern.  
- Add 1 hour at each touch, MAX to 12H.  
- Long touch to cancel the timer setting.

Night light button  : 1 touch: Changing colorful LED light.  
- 2 touch: Fixing a specific color.  
- 3 touch: Turn off the light.

Humidity  : Constant humidity mode.  
- 1 touch: Turn on the constant humidity mode.  
- The humidity range is between 30%-75%.  
- Add 5% at each touch.  
- Long touch 3s to cancel the constant humidity mode.

When current mist level is higher than target mist level. Mist will turn off. Fan will turn off in 3 minutes. Current mist level is 5% lower than desired mist level. Mist will restart again.



## AFTER EACH USE:

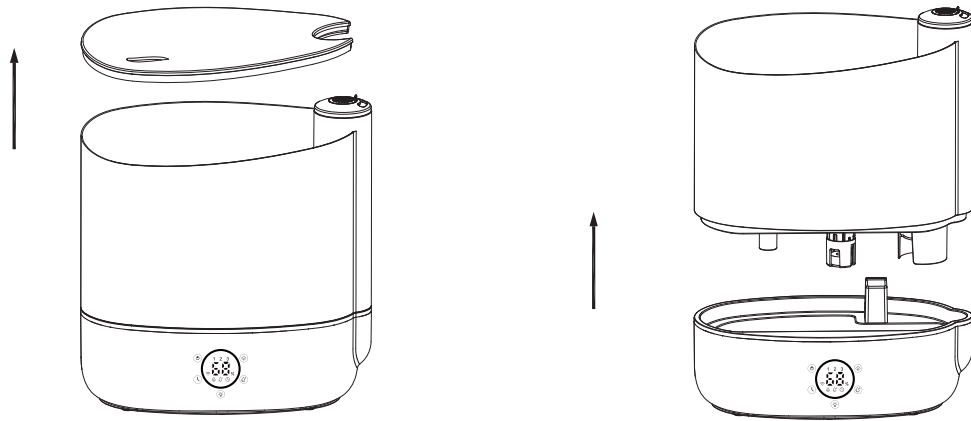

**Step 1:** Turn the device off and unplug the unit from electrical outlet. Then take off the top cover and water tank.

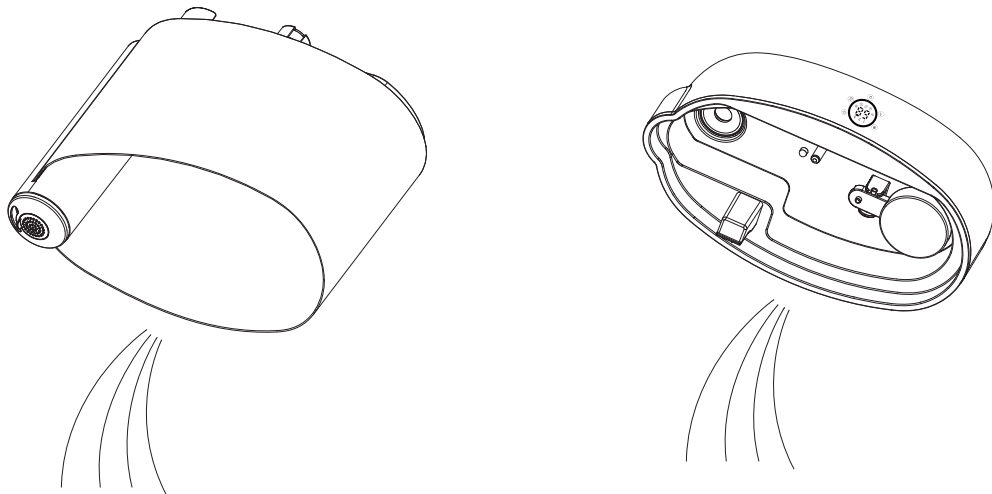

**Step 2:** Pour out the water from the water tank and main body then remove any sediment or dirt. Then wipe clean and dry with a clean soft cloth or tissue.

# USING Wi-fi CONTROL

## APPLICATION CONNECTION AND SHARE

Each device can be only connected with one smart phone(Host). For multiple people use, the "Host need to share it to the others.

### 1. Application Download

- Scan the QR code to download it.
- Android phone: Download it from Google Play by searching Cozylife.
- ios phone: Download it from App store by searching Cozylife.



### 2. Registration

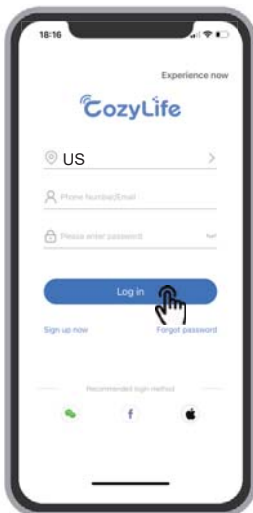

1.click on "log in"

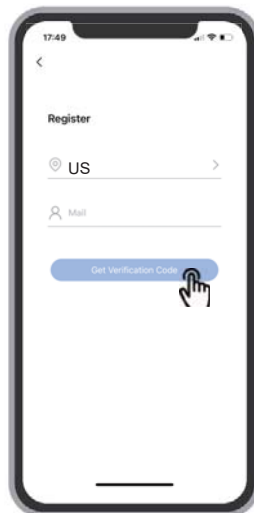

2.Enter your Email, then Click on "Get verification code"



3. Enter the verification code

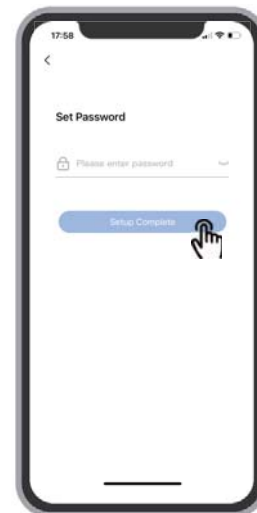

4.Set the password

### 3. Add device

Long press "📶" button to turn on wifi function.

Turn on the Bluetooth on your phone.

Make sure your phone connect to your 2.4G Wi-Fi network.

Follow below steps to connect your Application with the device.



1. Click "Add Device"

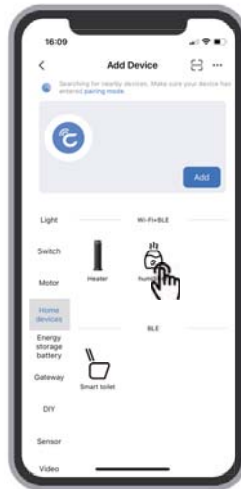

2. Click "Home devices", Chose "humidifier"



3. Click "Confirm device is in pairing state", then click "Next step"

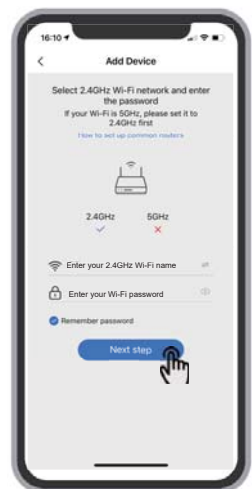

4. Enter your password", Then Click "Next step"



5. Click "To connect"



6. Chose your 2.4GHz Wi-Fi name

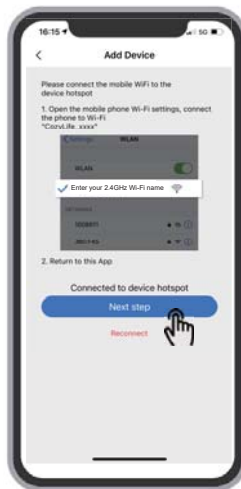

7. Click "Next step"

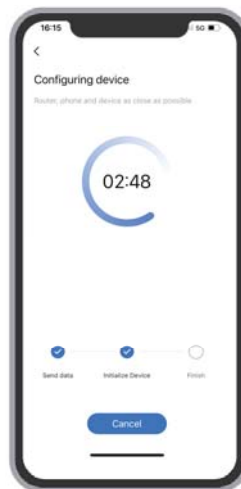

8. Waiting for pairing"



9. Wi-Fi connection successful

### PAY ATTENTION:

If the connection is failed:

1. Check if input wrong Wi-Fi name or password.
2. Both phone and the device must connect same Wi-Fi.
3. Only 2.4GHz Wi-Fi networks are supported, check your network.
4. During connection, keep your smart phone's Bluetooth on and close to the device.
5. Above steps must be finished within 3 mins. If time exceeds, connection will be failed, please repeat.
6. Restart your Wi-Fi device (Router, TV box) and try again.

 Bluetooth



2.4GHz ✓ 5GHz ✗

# CLEANING:

\* ALWAYS UNPLUG THE UNIT BEFORE CLEANING .

**INSIDE THE BASE OF THE UNIT:** Pour excess water out of the unit. Wash the unit with fresh water using a cleaning brush and soft cloth as needed. DO NOT submerge the Base of the unit into water.

**WATER TANK:** Remove top cover and empty the water tank. Clean the inside of water tank with fresh water and a soft bristle brush.

**OUTER SURFACE OF THE UNIT:** Wipe the surface of the unit with a soft, damp cloth if needed. If you notice an accumulation of water during usage, reduce humidity and dry outer surface with a cloth.

**DEEPER CLEANING + DESCALING:** Everyone's water content is different, so cleaning and scale removal may be required weekly or every other week to optimize unit performance. If scale becomes difficult to remove with brush, follow the steps below:

1. In a cup, combine 1 tsp of white vinegar and 1 tsp of water.
2. Let solution stand for 5 minutes.
3. Pour the mixture into the base, cleaning all interior surfaces with a soft cloth or brush to help remove scale.
4. Check Mist outlet and Mist Tube in Water Tank. Clean as needed.
5. Rinse the base thoroughly with water to remove remaining scale and the leftover vinegar solution.

## STORAGE:

1. Follow the Cleaning and Descaling instructions when the humidifier will not be in use for a long period.
2. Dry the humidifier completely before storing. DO NOT store with water inside the Base or Water Tank.
3. Pack the unit in its original box and store in a cool, dry location.

# TROUBLESHOOTING GUIDE:

\* CHECK THE FOLLOWING IF YOUR HUMIDIFIER IS NOT WORKING CORRECTLY:

| PROBLEM                                  | SOLUTION  |
|--|---|
| No mist comes out                        | Not enough water left: Refill the water tank.   |
|  | The humidity reached the set value.   |
| Abnormal mist                            | Clean the humidifier, especially the air outlet, and transducer.                                |
| Humidifier makes a loud or unusual noise | Make sure the water tank is properly in place.  |
|  | Place humidifier on a flat, level surface.  |
| The water tank had a bed smell           | Poor maintenance or dirty water:<br>Clean the product thoroughly, and fill it with fresh water. |
| The mist leak out                        | Make sure the top cover is firmly closed.   |
| The device can't work                    | There is no enough water:<br>Fill the water tank with enough water.                             |
|  | The adaptor is not connected properly:<br>Check and re-connect.                                 |
| No reaction when touch the button        | Make sure that the power is on, and touch again.  |

**FCC STATEMENT :**

This device complies with Part 15 of the FCC Rules. Operation is subject to the following two conditions:

(1) This device may not cause harmful interference, and

(2) This device must accept any interference received, including interference that may cause undesired operation.

**Warning:** Changes or modifications not expressly approved by the party responsible for compliance could void the user's authority to operate the equipment.

NOTE: This equipment has been tested and found to comply with the limits for a Class B digital device, pursuant to Part 15 of the FCC Rules. These limits are designed to provide reasonable protection against harmful interference in a residential installation. This equipment generates, uses and can radiate radio frequency energy and, if not installed and used in accordance with the instructions, may cause harmful interference to radio communications. However, there is no guarantee that interference will not occur in a particular installation. If this equipment does cause harmful interference to radio or television reception, which can be determined by turning the equipment off and on, the user is encouraged to try to correct the interference by one or more of the following measures:

- Reorient or relocate the receiving antenna.

- Increase the separation between the equipment and receiver.

- Connect the equipment into an outlet on a circuit different from that to which the receiver is connected.

- Consult the dealer or an experienced radio/TV technician for help.

**FCC Radiation Exposure Statement:**

This equipment complies with FCC radiation exposure limits set forth for an uncontrolled environment. This equipment should be installed and operated with minimum distance 20cm between the radiator & your body.

This device contains licence-exempt transmitter(s)/receiver(s) that comply with Innovation, Science and Economic Development Canada's licence-exempt RSS(s). Operation is subject to the following two conditions:

- (1) This device may not cause interference.
- (2) This device must accept any interference, including interference that may cause undesired operation of the device.

L' émetteur/récepteur exempt de licence contenu dans le présent appareil est conforme aux CNR d' Innovation, Sciences et Développement économique Canada applicables aux appareils radio exempts de licence. L' exploitation est autorisée aux deux conditions suivantes:

- (1) L' appareil ne doit pas produire de brouillage;
- (2) L' appareil doit accepter tout brouillage radioélectrique subi, même si le brouillage est susceptible d' en compromettre le fonctionnement.

ISED Radio Frequency Exposure Statement:

This equipment complies with IC exposure limits set forth for an uncontrolled environment. This equipment shall be installed and operated with minimum distance 20cm between the radiator & body.

ISED Déclaration d'exposition aux radiofréquences:

Cet équipement est conforme aux limites d'exposition IC définies pour un environnement non contrôlé. Cet équipement doit être installé et utilisé avec une distance minimale de 20 cm entre le radiateur et la carrosserie.

CAN ICES-003 (B) / NMB-003 (B)

This Class B digital apparatus complies with Canadian ICES-003.

(Cet appareil numérique de la Classe B conforme à la norme NMB-003 du Canada).

Responsible Party: VAVA INTERNATIONAL INC.

Company name: VAVA INTERNATIONAL INC.

Address: 20370 Town Center Lane Suite 208 Cupertino, CA 95014

Tel:510-767-8112

E-mail: [accounting@vava.com](mailto:accounting@vava.com)

|   |  |   |  |   |
|---|--|---|--|---|
|  | <a href="mailto:support@parishone.com">support@parishone.com</a>   |  | <a href="http://www.parishone.com">www.parishone.com</a> |  |
|  | Manufacturer: Shenzhen Aspiron Technology Company Limited<br>Address: 3rd Floor, Yiben Building, No.1063 Chaguang Road, Xili Street,<br>Nanshan District, Shenzhen, Guangdong, China |   |  | Made In China   |



Questions or Concerns?

[support@parisrhone.com](mailto:support@parisrhone.com)