

SPECIFICATION

SHEET FOR APPROVAL

(Revision: R: A1)

CUSTOMER(客户名称)	高盛达
CS P/N(客户机种)	WXT2J
PART NAME(品名)	WIFI-1 天线
FREQUENCY(频率)	2.4GHz+5GHz+6GHz
ZTX NO.(物料编号)	1.01.01982
DATE(日期)	2021-09-02

CUSTOMER			
QA CHECKED	ME CHECKED	RF CHECKED	MANAGER CHECKED

Remark(备注):

Sign(客户确认签字盖章): _____

ZHONG TIAN XUN TECHNOLOGY CO., LTD				
MANAGER CHECKED	MANAGER CHECKED	ME CHECKED	RF CHECKED	LISTER
		邹一麟	赵烽	



深圳市中天迅通信技术股份有限公司

SHENZHEN ZHONGTIAN XUN Communication Technology Co.,Ltd.

地址: 深圳市宝安区石岩镇石龙大道 34 号(腾达工业园) 邮编: 518000
电话: 0755-27588320 传真: 0755-27588045 <http://www.chinaztx.com>

ANTENNA SPECIFICATION

CUS P/N :WXT2J WIFI-1 天线
ZTX P/N :WXT2J WIFI-1 天线

ApplicationDate:Sep,02,2021
Editor:

Rev: R:A1
Page 1 of 14

Revision history

版本	日期	状态
A1	2021-09-02	首版

ANTENNA SPECIFICATION

CUS P/N :WXT2J WIFI-1 天线

ApplicationDate:Sep,02,2021

Rev: R:A1

ZTX P/N :WXT2J WIFI-1 天线

Editor:

Page 2 of 14

Index

		Revision history	1
		Index	2
1		Mechanical Specification	3
	5-1	Mechanical Specification (WIFI-1 天线)	3
2		Test equipment	4
3		Product figure	5
4		Antenna test data	5
	4-1	VSWR	5
	4-2	Matching circuit	6
	4-3	No-source test data	6
	4-4	Directional drawing of horizontal plane of&3D radiation drawing	7~9
	4-5	Isolation test	10~11
5		Environment Characteristic	12
6		Raw Material Detection List	12
7		The packing way	13
		附页： 出货标签模板	14



ANTENNA SPECIFICATION

CUS P/N :WXT2J WIFI-1 天线
ZTX P/N :WXT2J WIFI-1 天线

ApplicationDate:Sep,02,2021
Editor:

Rev: R:A1
Page 3 of 14

1. Mechanical Specification

1-1 Mechanical Configuration(WIFI-1 天线)

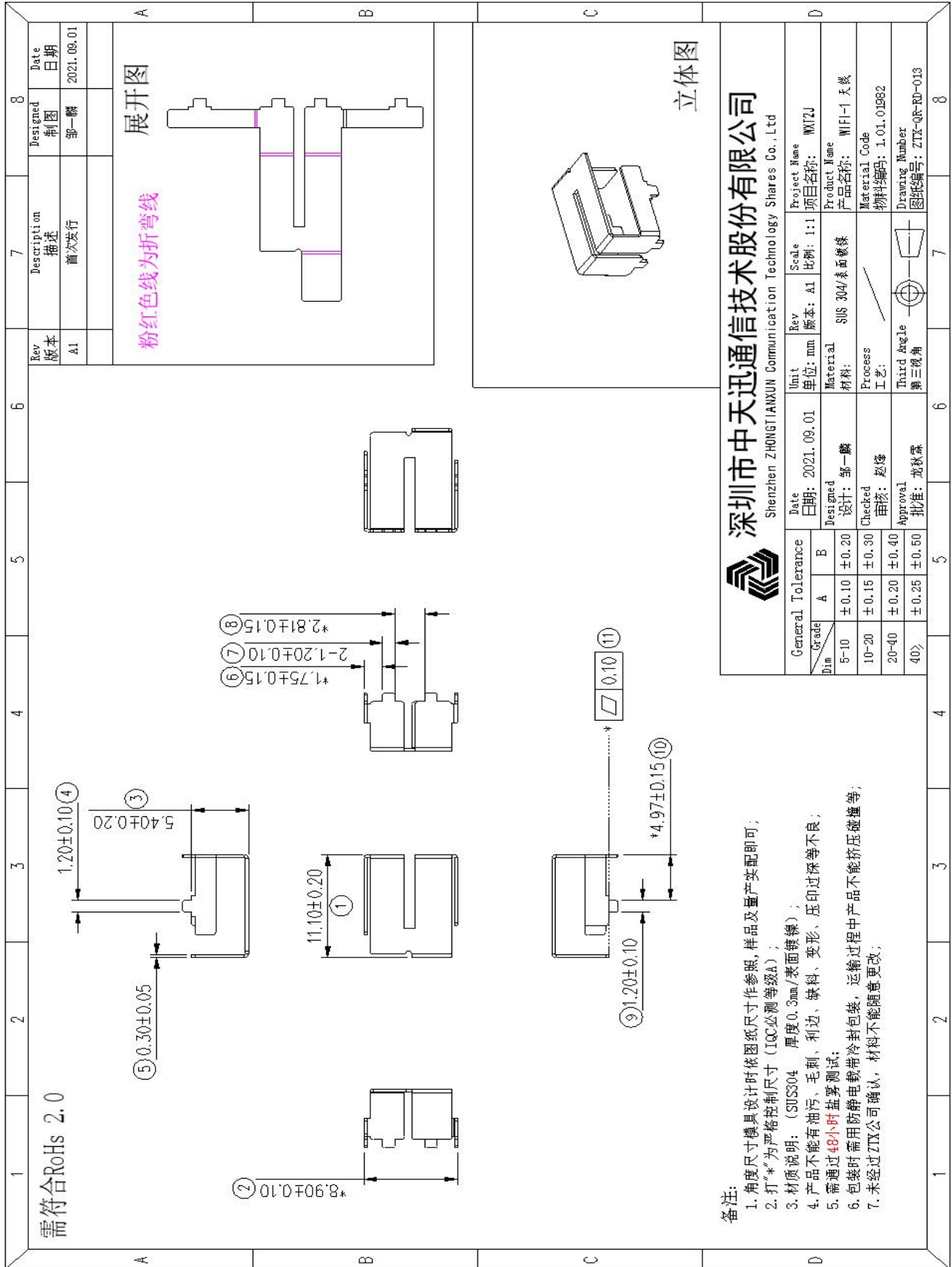

ANTENNA SPECIFICATION

CUS P/N :WXT2J WIFI-1 天线

ZTX P/N :WXT2J WIFI-1 天线

ApplicationDate:Sep,02,2021

Editor:

Rev: R:A1

Page 4 of 14

2. Test equipment

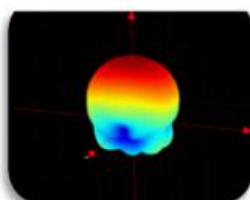
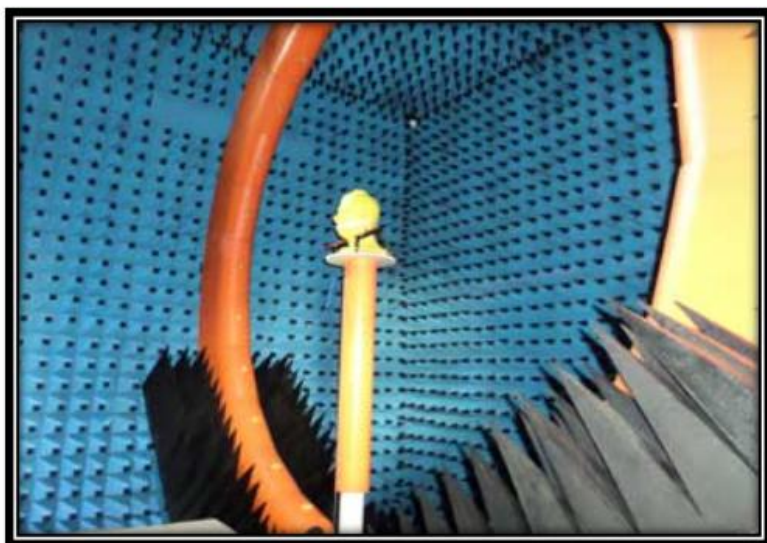

Owned 6 microwave dark room, equipped 2 sets world leading France Satimo SG24 OTA certification test systems (one in SHENZHEN, another one in Shanghai), ETS OTA Standard test system, Blue test reverberation test system which is High repeatability, high accuracy and high resolution. It can quickly provide accurate test reports, fully meet the CITA standards.

Testing range:

Support active, passive testing of GSM/CDMA/WCDMA/TD-SCDMA/LTE/WIFI/WLAN/WiMax/BT/GPS/MIMO/UWB within 0.4-6G.

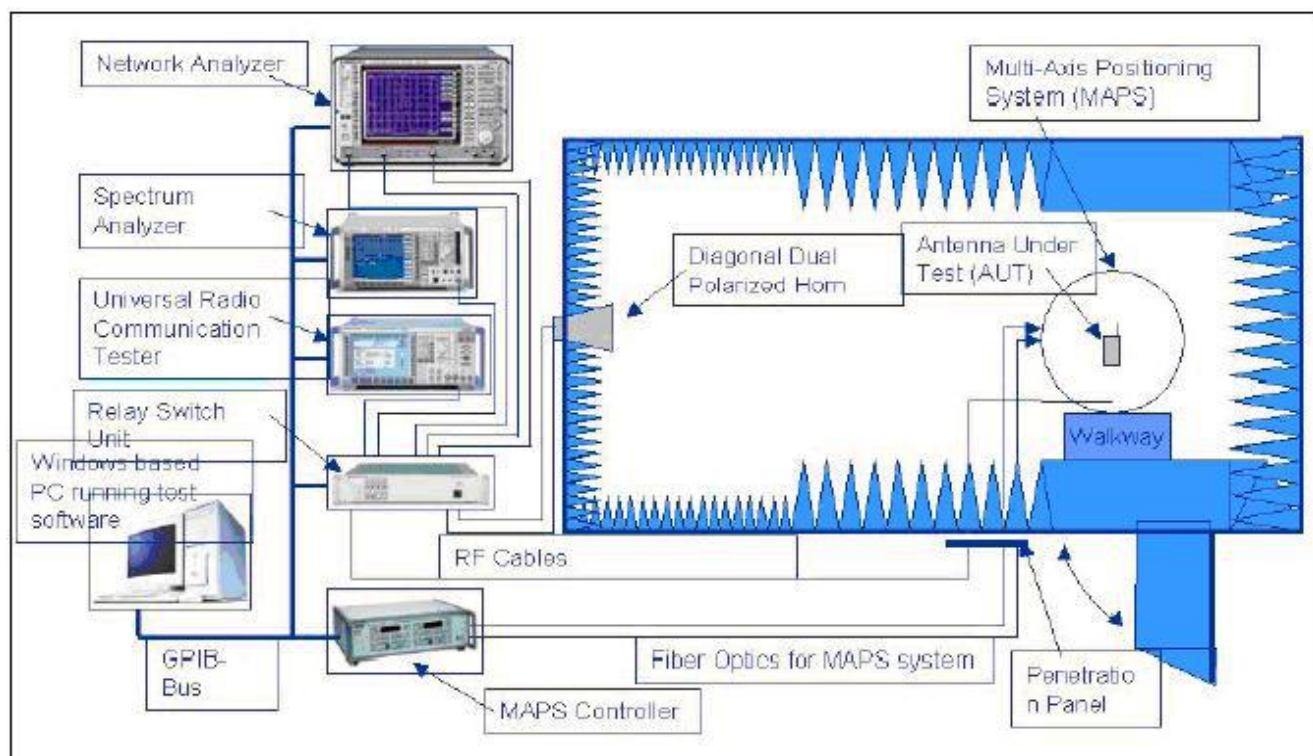

ANTENNA SPECIFICATION

CUS P/N :WXT2J WIFI-1 天线

ZTX P/N :WXT2J WIFI-1 天线

ApplicationDate:Sep,02,2021

Editor:

Rev: R:A1

Page 5 of 14

3.Product figure

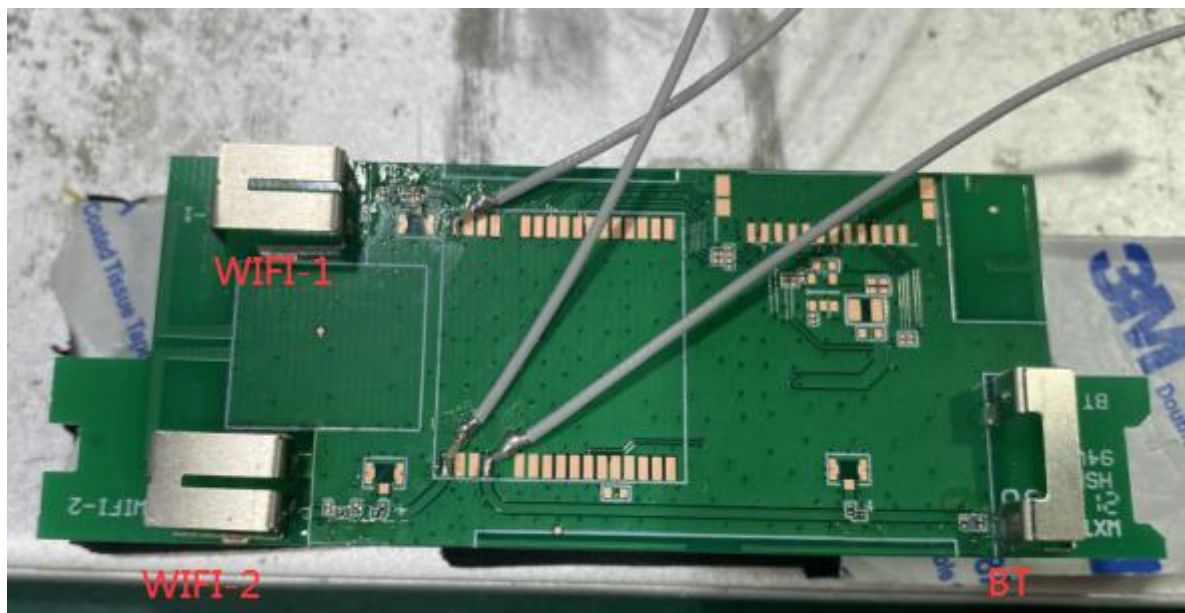

4.Antenna test data

4-1 VSWR

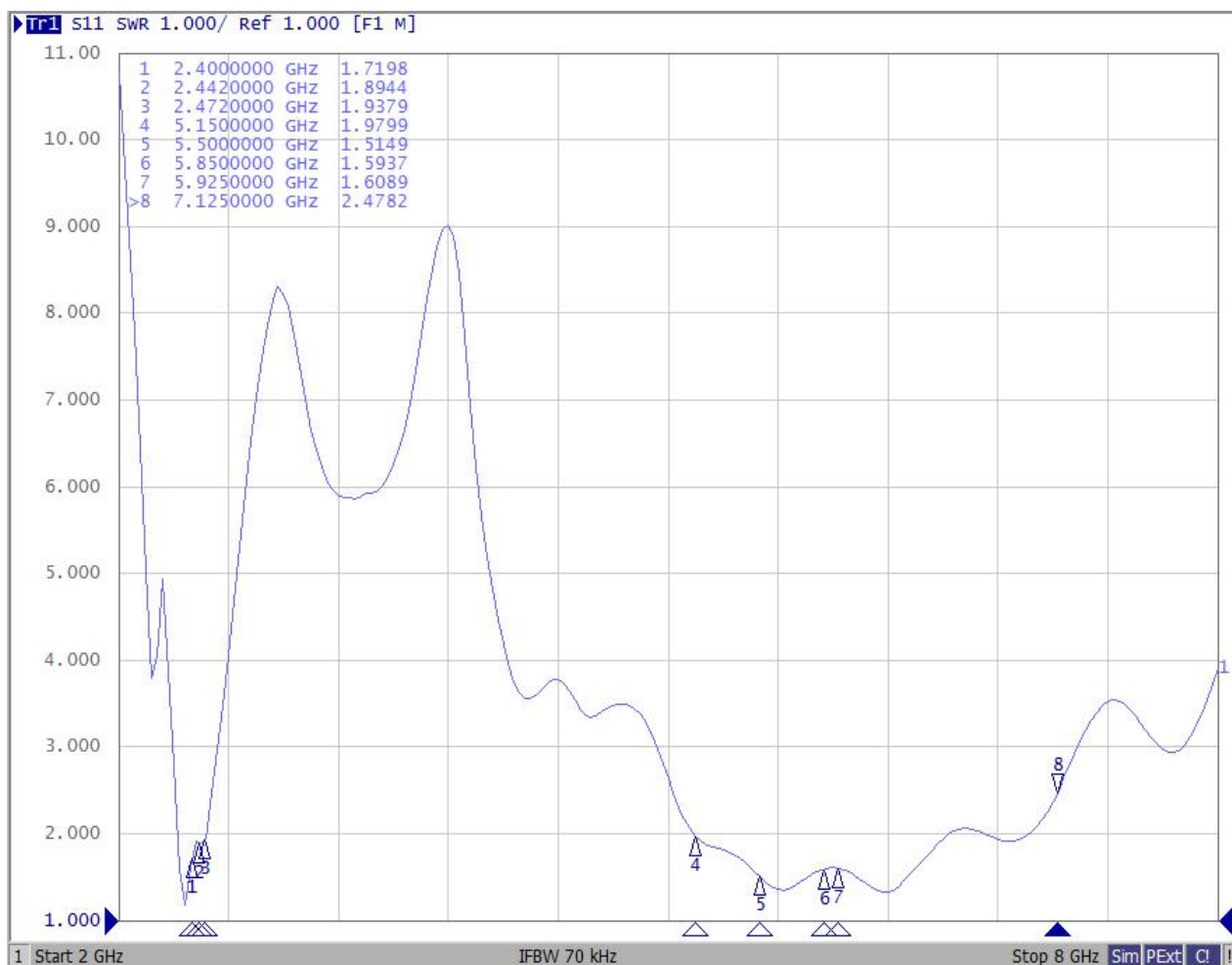

ANTENNA SPECIFICATION

CUS P/N :WXT2J WIFI-1 天线

ZTX P/N :WXT2J WIFI-1 天线

ApplicationDate:Sep,02,2021

Editor:

Rev: R:A1

Page 6 of 14

4-2 Matching circuit

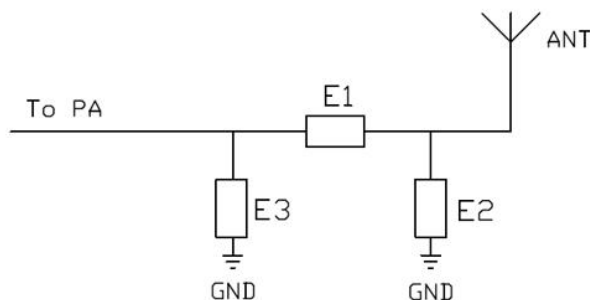

匹配说明	WIFI-1	WIFI-2	BT
E1	0欧姆	0欧姆	3.3nH
E2	NC	NC	NC
E3	NC	NC	NC

4-3 No-source test data

Frequency Mhz	Peak Gain dB	Efficiency	
		%	dB
2400	4.98	46.00	-3.37
2410	4.80	45.22	-3.45
2420	4.83	45.59	-3.41
2430	4.80	46.78	-3.30
2440	4.69	45.94	-3.38
2450	4.47	45.58	-3.41
2460	4.25	44.65	-3.50
2470	4.03	44.46	-3.52
2480	3.91	43.71	-3.59
2490	4.04	43.59	-3.61
2500	3.52	41.57	-3.81
5150	6.06	52.46	-2.80
5250	6.51	54.62	-2.63
5350	6.18	57.26	-2.42
5450	5.07	55.20	-2.58
5550	5.02	56.22	-2.50
5650	5.66	59.34	-2.27
5750	5.62	59.51	-2.25
5850	5.48	55.88	-2.53

Frequency Mhz	Peak Gain dB	Efficiency	
		%	dB
5925	5.48	56.51	-2.48
6025	5.76	53.61	-2.71
6125	6.15	55.30	-2.57
6225	6.66	54.95	-2.60
6325	6.79	52.17	-2.83
6425	6.44	48.79	-3.12
6525	6.51	47.18	-3.26
6625	6.90	45.83	-3.39
6725	6.44	46.76	-3.30
6825	6.59	44.61	-3.51
6925	5.97	43.96	-3.57
7025	5.82	41.25	-3.85
7125	5.39	40.23	-3.95

ANTENNA SPECIFICATION

CUS P/N :WXT2J WIFI-1 天线
ZTX P/N :WXT2J WIFI-1 天线

ApplicationDate:Sep,02,2021
Editor:

Rev: R:A1
Page 7 of 14

4-4 Directional drawing of horizontal plane of&3D radiation drawing 2.4GHz

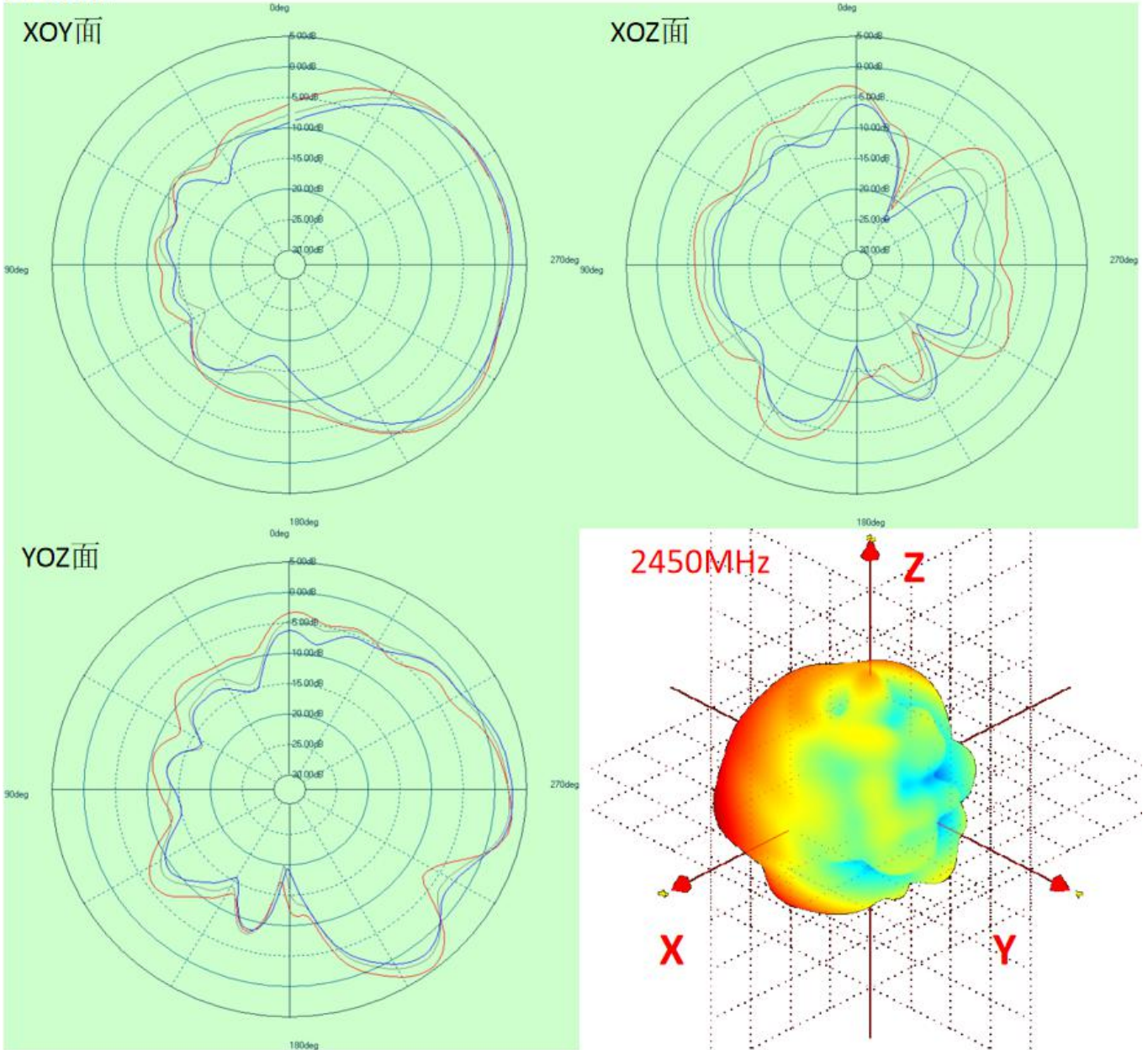

ANTENNA SPECIFICATION

CUS P/N :WXT2J WIFI-1 天线

ZTX P/N :WXT2J WIFI-1 天线

ApplicationDate:Sep,02,2021

Editor:

Rev: R:A1

Page 8 of 14

5GHz

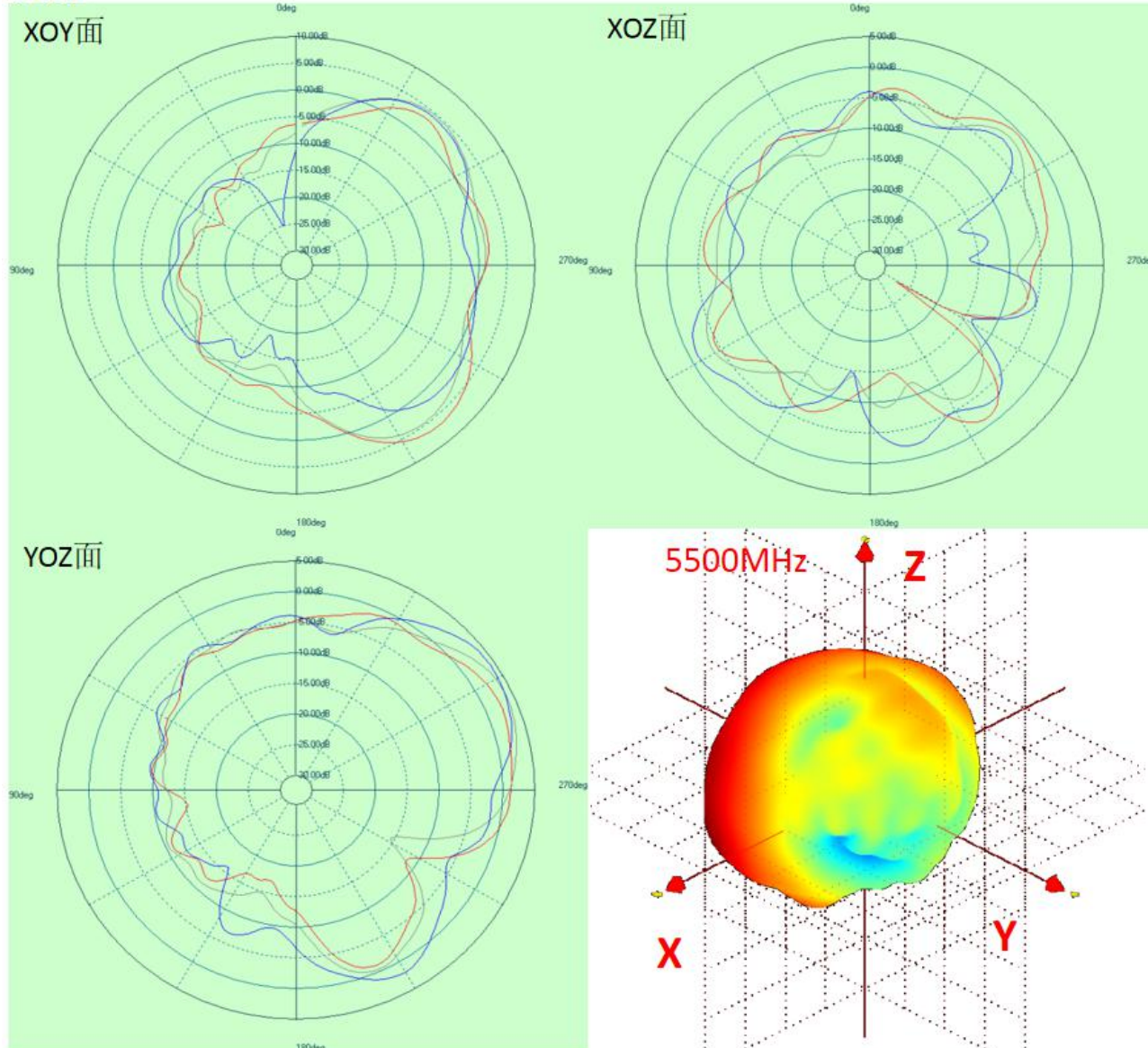

ANTENNA SPECIFICATION

CUS P/N :WXT2J WIFI-1 天线
ZTX P/N :WXT2J WIFI-1 天线

ApplicationDate:Sep,02,2021
Editor:

Rev: R:A1
Page 9 of 14

6GHz

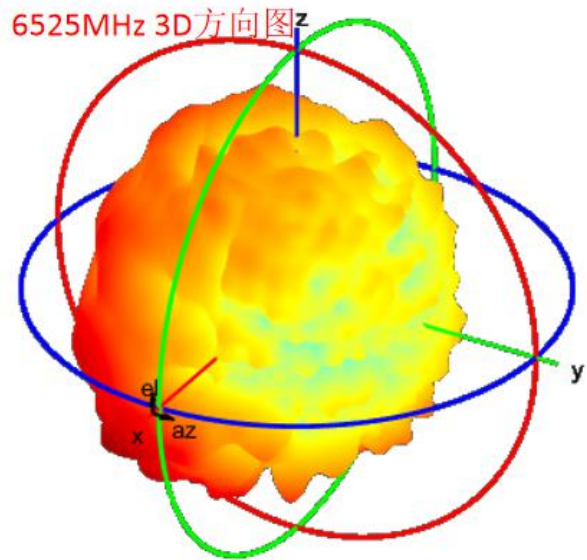
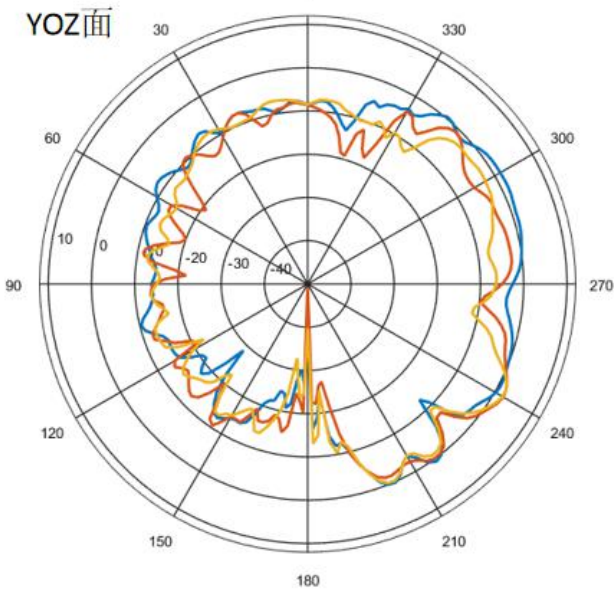
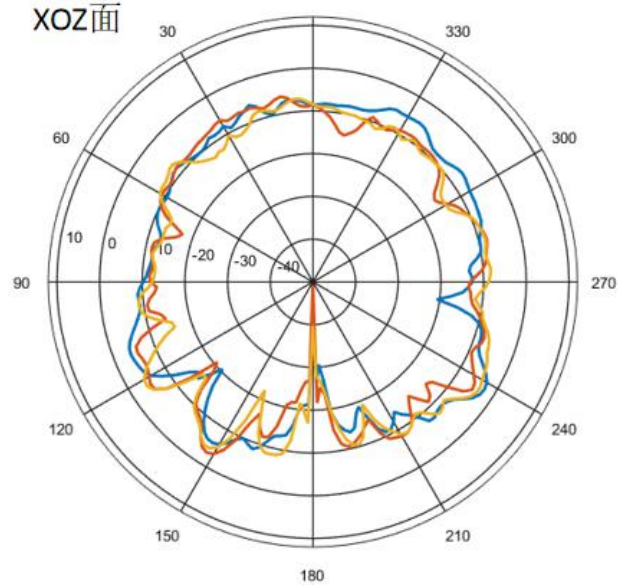
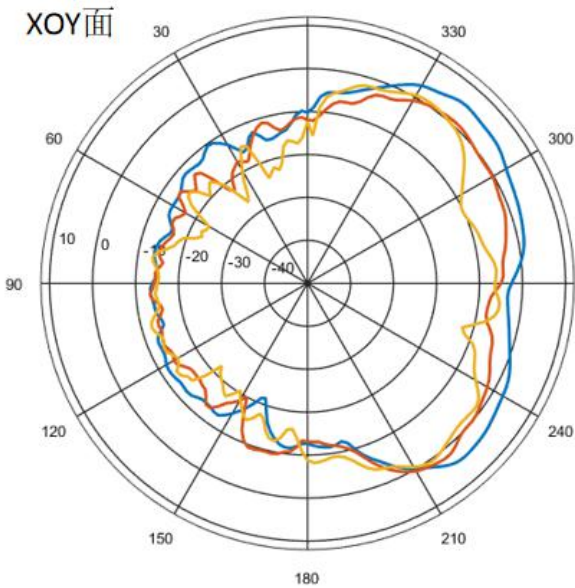

ANTENNA SPECIFICATION

CUS P/N :WXT2J WIFI-1 天线
 ZTX P/N :WXT2J WIFI-1 天线

ApplicationDate:Sep,02,2021
 Editor:

Rev: R:A1
 Page 10 of 14

4-5 Isolation test

WiFi-1与WiFi-2天线

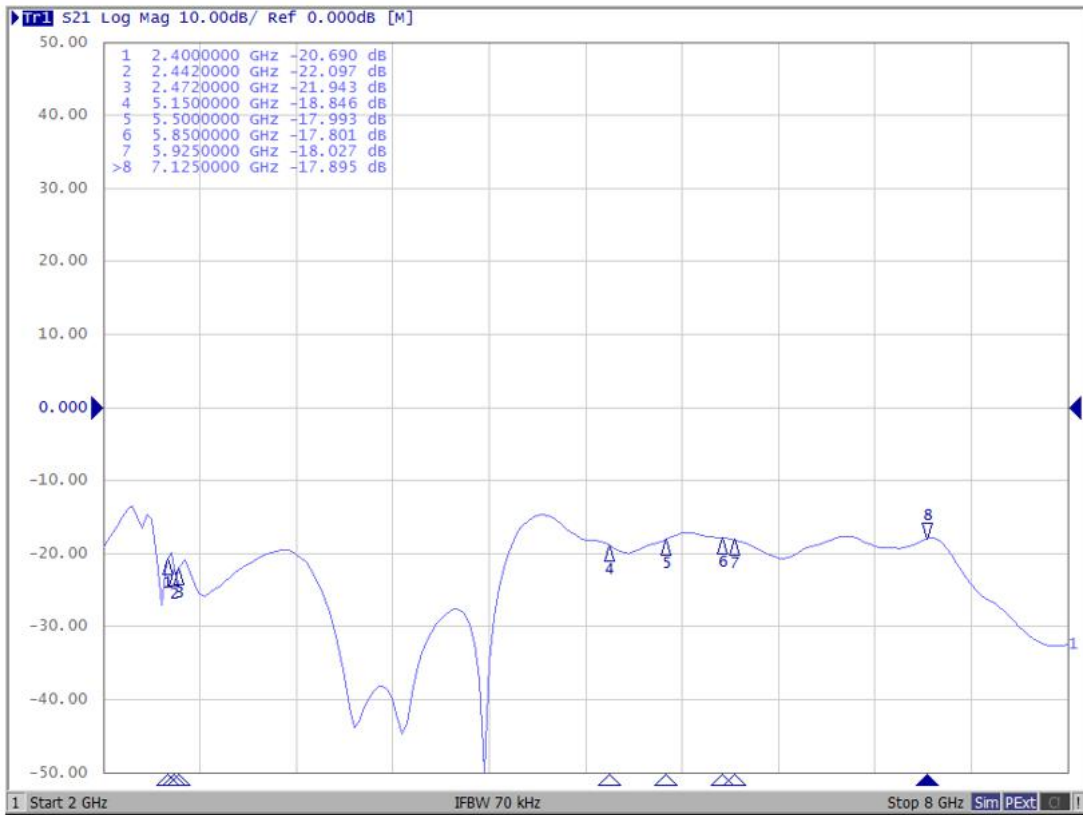

WiFi-1与BT天线

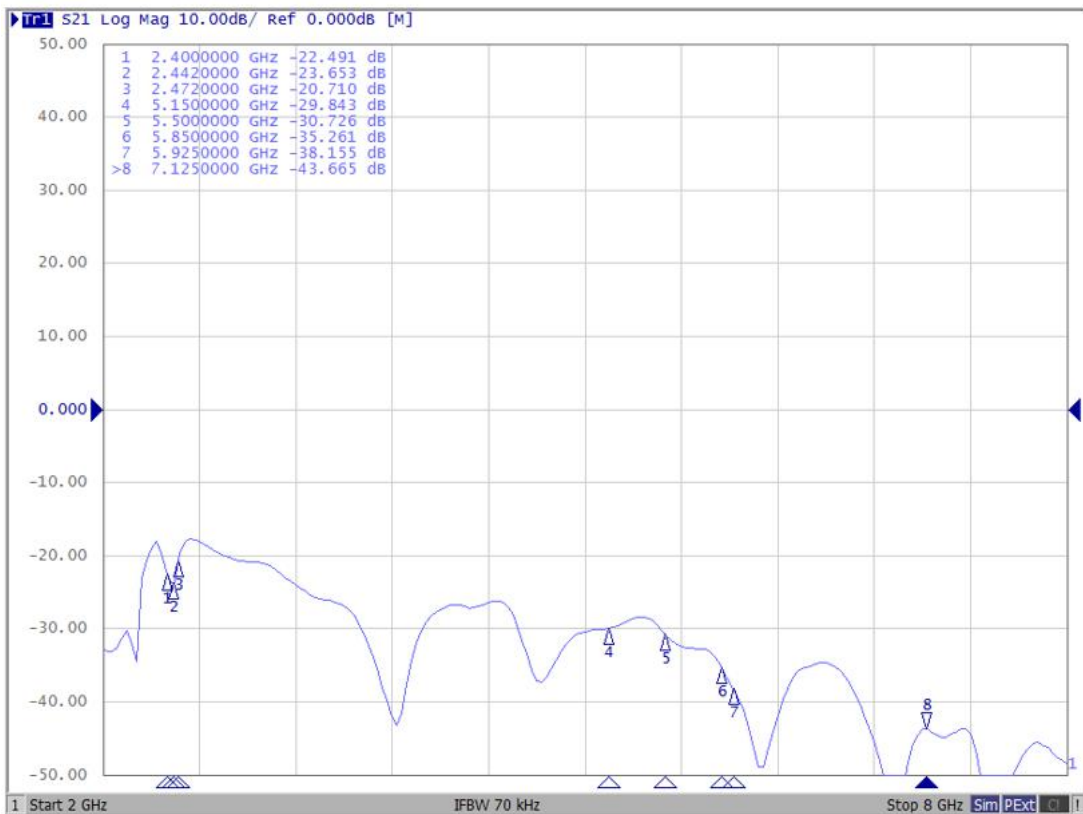

ANTENNA SPECIFICATION

CUS P/N :WXT2J WIFI-1 天线

ApplicationDate:Sep,02,2021

Rev: R:A1

ZTX P/N :WXT2J WIFI-1 天线

Editor:

Page 11 of 14

WiFi-2与BT天线

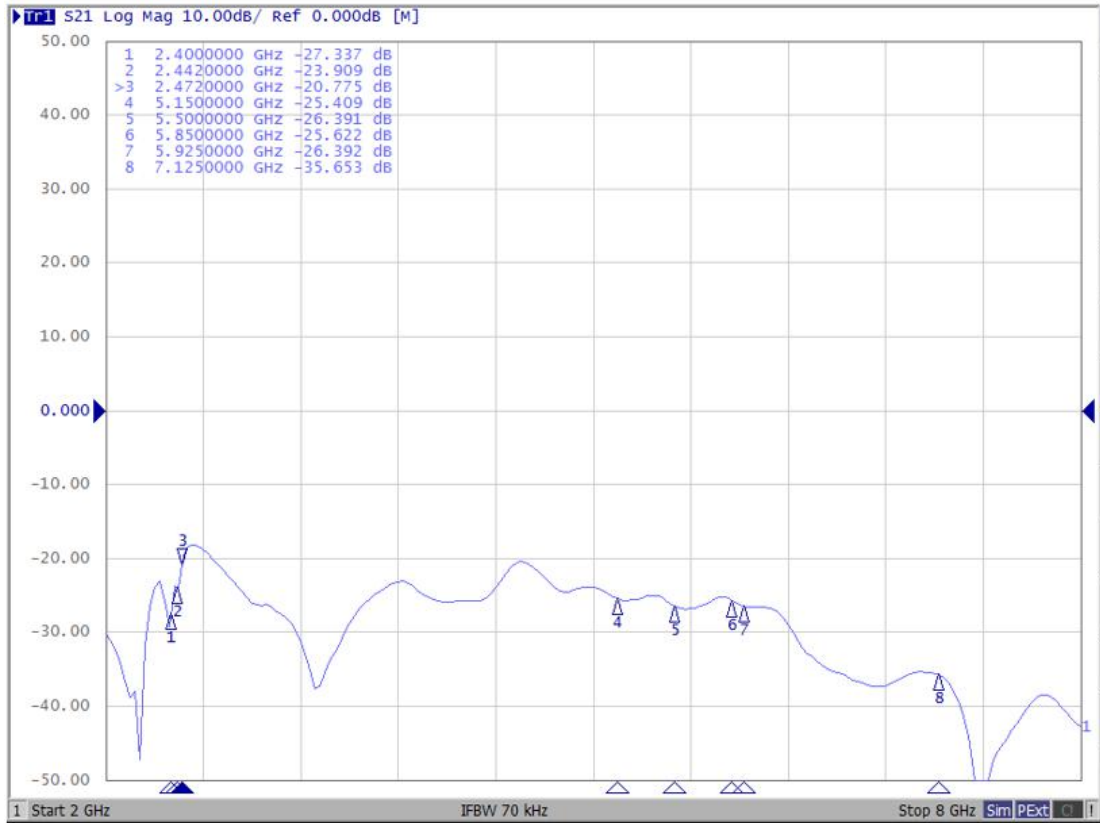

ANTENNA SPECIFICATION

CUS P/N :WXT2J WIFI-1 天线

ApplicationDate:Sep,02,2021

Rev: R:A1

ZTX P/N :WXT2J WIFI-1 天线

Editor:

Page 12 of 14

5. Environment Characteristic

NO.	ITEM	TEST CONDITION	SPECIFICATION
5-1	High Temperature/Humidity Storage Test(non operating)	1.Temperature: $+80 \pm 2^{\circ}\text{C}$ 2.Humidity: $90\sim 95\%RH$ 3.Time: 48hrs	No material deformation is allowed.
5-2	Low Temperature/Humidity Storage Test(non operating)	1.Temperature: $-30 \pm 2^{\circ}\text{C}$ 2.Humidity: $0\%RH$ 3.Time: 48hrs	The VSWR, Gain, Radiation Pattern must be met specifications after these test.

6.Raw Material Detection List

描述 Description	Material/Type name 原材料名称/型号	Raw Material Manufacturers 原材料制造商名称	Test Lab 测试机 构名称	Test Report NO. 测试报告编号	Report date 测试日期	Validity Date (有 效日期)	Remark 备注
1	SUS304	HESHENG	SGS	SZXEC2100804202	2021/3/30	2022/3/29	 SUS304 SZXEC21008042







ANTENNA SPECIFICATION

CUS P/N :WXT2J WIFI-1 天线
ZTX P/N :WXT2J WIFI-1 天线

ApplicationDate:Sep,02,2021
Editor:

Rev: R:A1
Page 13 of 14

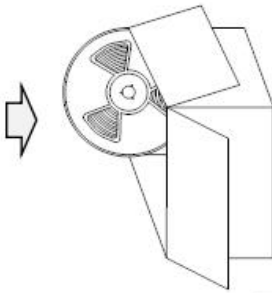
7.The packing way

深圳市中天迅通信技术有限公司 SHENZHEN ZHONGTIAN XUN Communication Technology Co.,Ltd.				包装规范					
产品名称	产品型号	文件编号	版本	工序序号/名称	工序工时	日产量			
天线	WXT2J	ZTX-QD-WI	A1	包装/装箱	/	/			
 <p>图1：载带包装</p>				<p>作业方法（自检验工序作业合格者后，方能流入下一道工序）</p> <ol style="list-style-type: none"> 每XXXXPCS/盘，贴内标签，内标签包含（物料名称，物料型号，物料编码，数量）； 将载带包装好的产品装入箱内（每箱装XX盘（XXXXXXPCS））尾数除外； 在装好产品的箱子将标签贴于外箱的右上角，标签内容包含（生产厂家，型号，产品名称，客户编码，数量，订单号，日期，QA检验，客户所提月份标RoHS等）不可有漏写，写错现象； 将贴好标签的箱子用胶纸以“工”字型封箱。 					
 <p>图2：XXXpcs/盘</p>				<p>物料名称</p> <p>防静电编带</p> <p>纸箱</p> <p>标签</p>				<p>用量</p> <p>XX</p> <p>1</p> <p>/</p>	
 <p>图3：装箱</p>				<p>物料编码</p>				<p>使用工具</p>	
 <p>图4：贴外箱标签、封箱</p>									
<p>修订内容</p> <p>初版</p>				<p>修订日期</p> <p>2021/9/2</p>		<p>修订人</p> <p>陈浩</p>			
版本	A0	易爱玲	审核	陈浩	胡春梅	批准	龙秋霖		

ANTENNA SPECIFICATION

CUS P/N :WXT2J WIFI-1 天线

ApplicationDate:Sep,02,2021

Rev: R:A1

ZTX P/N :WXT2J WIFI-1 天线

Editor:

Page 14 of 14

附页： 出货标签模板

N/A

