

TEST REPORT

Report No.: BCTC2403806317-4E

Applicant: Acer India PVT Limited

Product Name: Laptop

Test Model: Aspire 3 A325-51

Tested Date: 2024-03-22 to 2024-04-17

Issued Date: 2024-04-17

Shenzhen BCTC Testing Co., Ltd.



FCC ID: 2A94K-A325-51

Product Name: Laptop

Trademark: 

Model/Type reference: Aspire 3 A325-51

Prepared For: Acer India PVT Limited

Address: Acer India PVT Limited, 6th Floor, Embassy Heights, No.13, Magrath Road, Bangalore, 560025, India

Manufacturer: Acer India PVT Limited

Address: RS No.38/2, Sedarapet Village Villianur Commune, Pondicherry-605111

Prepared By: Shenzhen BCTC Testing Co., Ltd.

Address: 1-2/F., Building B, Pengzhou Industrial Park, No.158, Fuyuan 1st Road, Zhancheng, Fuhai Subdistrict, Bao'an District, Shenzhen, Guangdong, China

Sample Received Date: 2024-03-22

Sample tested Date: 2024-03-22 to 2024-04-17

Issue Date: 2024-04-17

Report No.: BCTC2403806317-4E

Test Standards: FCC Part15 15.407
ANSI C63.10-2013
KDB 662911 D01 v02r01
KDB 789033 D02 v02r01

Test Results: PASS

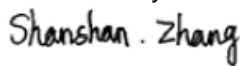
Tested by:

Shanshan. Zhang / Project Handler

Approved by:

Zero Zhou/Reviewer

The test report is effective only with both signature and specialized stamp. This result(s) shown in this report refer only to the sample(s) tested. Without written approval of Shenzhen BCTC Testing Co., Ltd, this report can't be reproduced except in full. The tested sample(s) and the sample information are provided by the client.

Table Of Content

	Page
Test Report Declaration	
1. Version	5
2. Test Summary	6
3. Measurement Uncertainty	7
4. Product Information And Test Setup	8
4.1 Product Information.....	8
4.2 Test Setup Configuration	9
4.3 Support Equipment	9
4.4 Channel List.....	9
4.5 Test Mode	10
4.7 Antenna.....	11
5. Test Facility And Test Instrument Used.....	12
5.1 Test Facility.....	12
5.2 Test Instrument Used.....	12
6. Conducted Emissions.....	14
6.1 Block Diagram Of Test Setup.....	14
6.2 Limit	14
6.3 Test Procedure	14
6.4 EUT Operating Conditions	14
6.5 Test Result.....	15
7. Radiated Emissions.....	19
7.1 Block Diagram Of Test Setup.....	19
7.2 Limit	20
7.3 Test Procedure	22
7.4 EUT Operating Conditions	23
7.5 Test Result.....	23
8. Power Spectral Density Test	64
8.1 Block Diagram Of Test Setup.....	64
8.2 Limit	64
8.3 Test Procedure	65
8.4 EUT Operating Conditions	65
8.5 Test Result.....	66
9. 26dB & 6dB & 99% Emission Bandwidth	88
9.1 Block Diagram Of Test Setup.....	88
9.2 Limit	88
9.3 Test Procedure	88
9.4 EUT Operating Conditions	89
9.5 Test Result.....	90
10. Maximum Conducted Output Power.....	132
10.1 Block Diagram Of Test Setup.....	132
10.2 Limit	132
10.3 Test Procedure	132
10.4 EUT Operating Conditions	133
10.5 Test Result.....	134

11. Out Of Band Emissions	136
11.1 Block Diagram Of Test Setup.....	136
11.2 Limit	136
11.3 Test Procedure	136
11.4 EUT Operating Conditions	136
11.5 Test Result.....	136
12. Spurious RF Conducted Emissions.....	155
12.1 Block Diagram Of Test Setup.....	155
12.2 Limit	155
12.3 Test Procedure	155
12.4 Test Result.....	155
13. Frequency Stability Measurement	176
13.1 Block Diagram Of Test Setup.....	176
13.2 Limit	176
13.3 Test Procedure	176
13.4 Test Result.....	177
14. Duty Cycle Of Test Signal	183
14.1 Standard Requirement	183
14.2 Formula.....	183
14.3 Test Procedure	183
14.4 Test Result.....	183
15. Antenna Requirement	227
15.1 Limit	227
15.2 Test Result.....	227
16. EUT Photographs.....	228
17. EUT Test Setup Photographs.....	229

(Note: N/A Means Not Applicable)

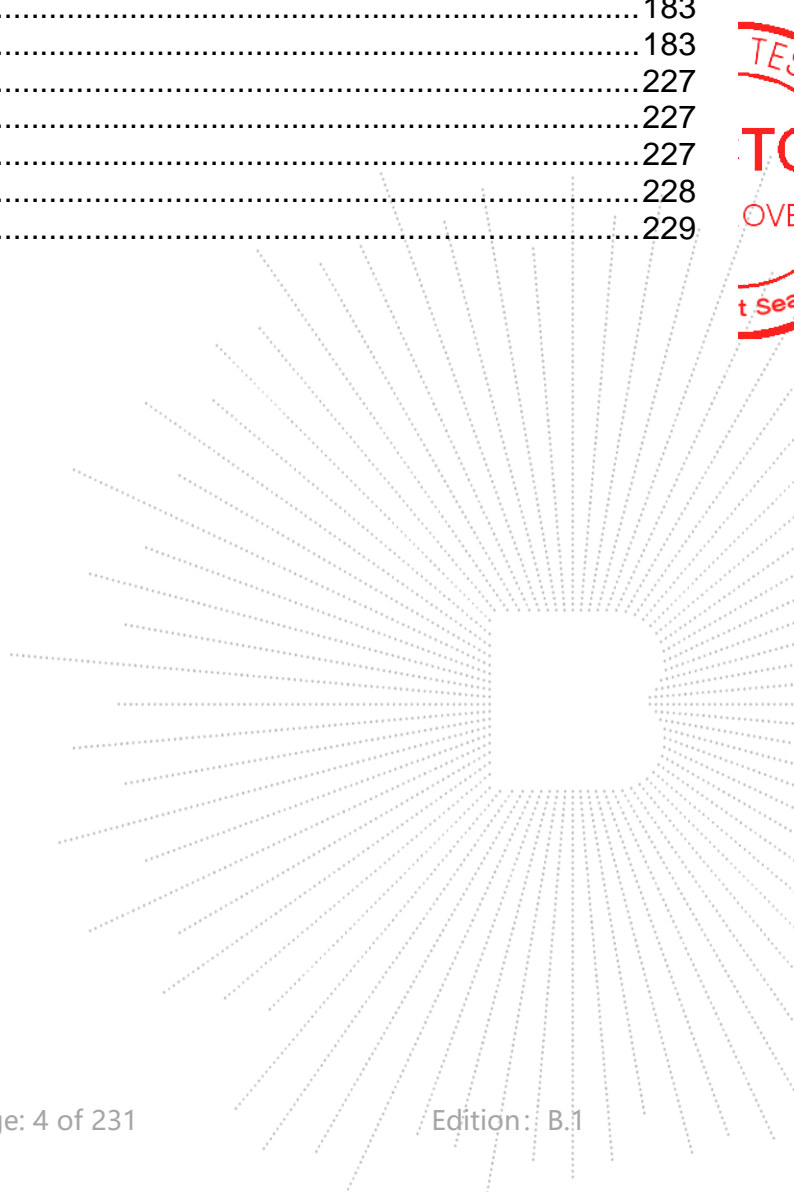

TEC
TC
OVB
t See

1. Version

Report No.	Issue Date	Description	Approved
BCTC2403806317-4E	2024-04-17	Original	Valid

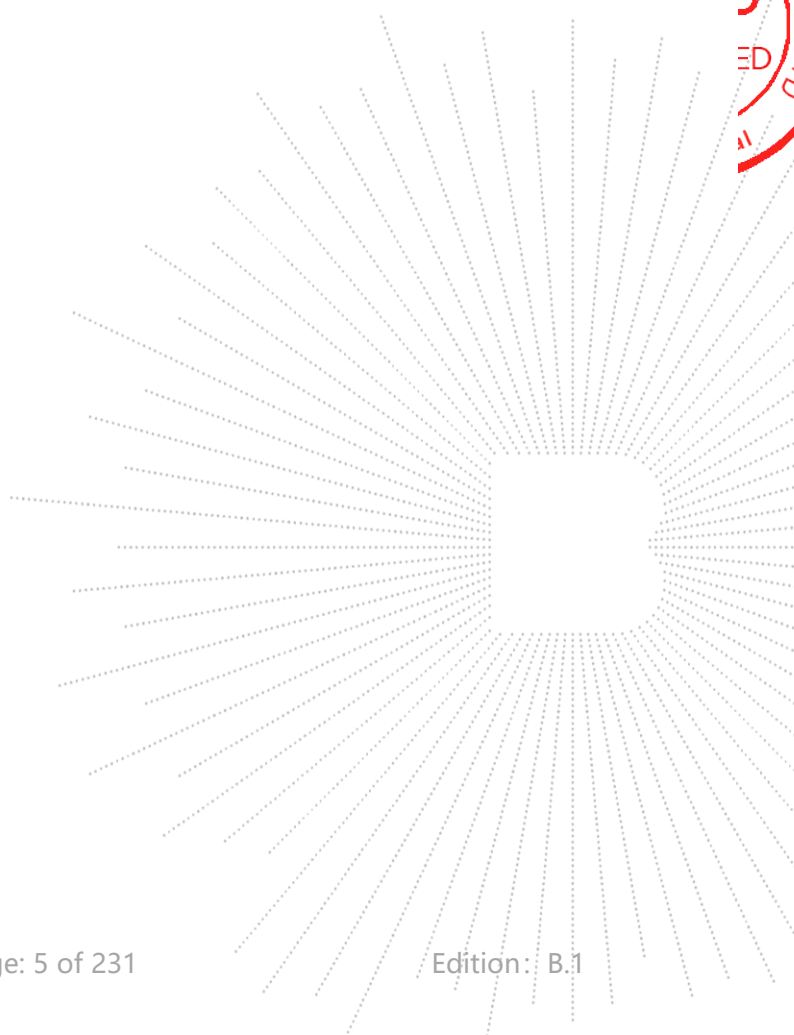

2. Test Summary

The Product has been tested according to the following specifications:

No.	Test Parameter	Clause No	Results
1	Spurious Radiated Emissions	15.209(a), 15.407 (b)(1) 15.407 (b)(4) 15.407 (b)(8)	PASS
2	Conducted Emission	15.207	PASS
3	26 dB and 99% Emission Bandwidth	15.407 (a)(12) 15.1049	PASS
4	Minimum 6 dB bandwidth	15.407(e)	PASS
5	Maximum Conducted Output Power	15.407 (a)(1) 15.407 (a)(3)	PASS
6	Band Edge	2.1051, 15.407(b)(1) 15.407(b)(4)	PASS
7	Power Spectral Density	15.407 (a)(1) 15.407 (a)(3)	PASS
8	Spurious Emissions at Antenna Terminals	2.1051, 15.407(b)	PASS
9	Antenna Requirement	15.203	PASS

 CO. LTD

3. Measurement Uncertainty

Where relevant, the following measurement uncertainty levels have been estimated for tests performed on the Product as specified in CISPR 16-4-2. This uncertainty represents an expanded uncertainty expressed at approximately the 95% confidence level using a coverage factor of k=2.

No.	Item	Uncertainty
1	3m chamber Radiated spurious emission(9kHz-30MHz)	U=3.7dB
2	3m chamber Radiated spurious emission(30MHz-1GHz)	U=4.3dB
3	3m chamber Radiated spurious emission(1GHz-18GHz)	U=4.5dB
4	3m chamber Radiated spurious emission(18GHz-40GHz)	U=3.34dB
5	Conducted Emission(150kHz-30MHz)	U=3.20dB
6	Conducted Adjacent channel power	U=1.38dB
7	Conducted output power uncertainty Above 1G	U=1.576dB
8	Conducted output power uncertainty below 1G	U=1.28dB
9	humidity uncertainty	U=5.3%
10	Temperature uncertainty	U=0.59°C

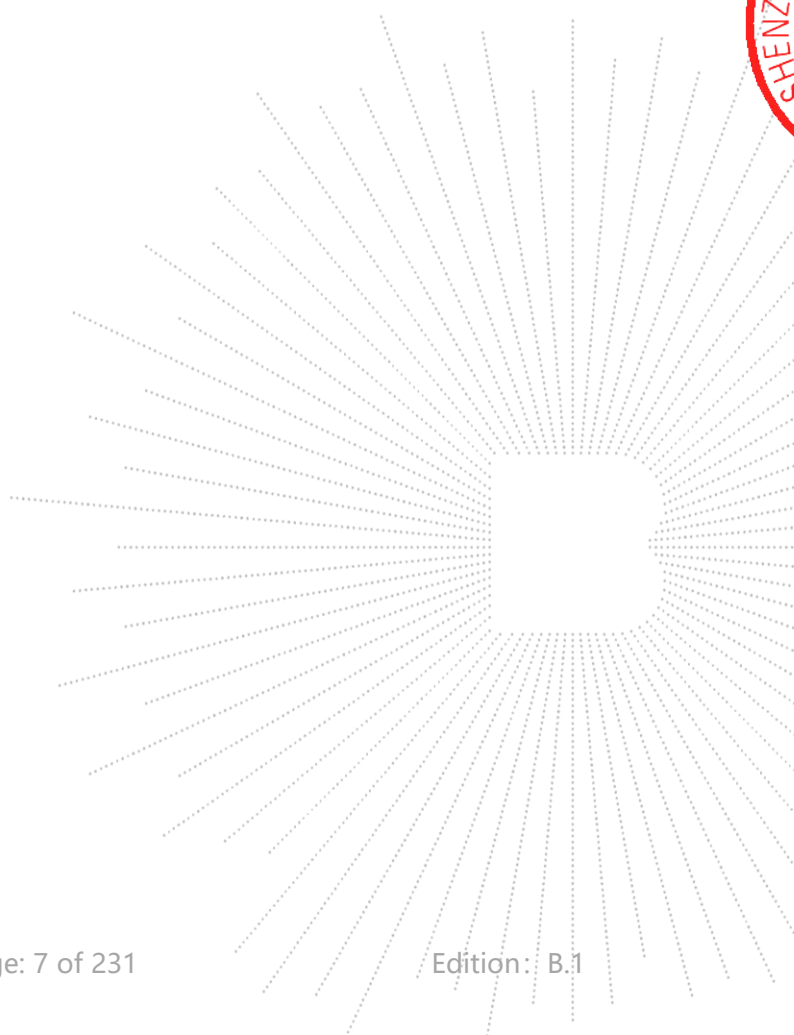
4. Product Information And Test Setup

4.1 Product Information

Model/Type reference:	Aspire 3 A325-51
Model differences:	N/A
Hardware Version:	TU141AL REV: 2.1A
Software Version:	Windows 11 Home 22H2
IEEE 802.11 WLAN Mode Supported	802.11a/n/ac/ax(20MHz channel bandwidth) 802.11n/ac/ax(40MHz channel bandwidth) 802.11ac/ax(80MHz channel bandwidth) 5180-5240MHz for 802.11a/n/ax(HT20); 5190-5230MHz for 802.11n/ax(HT40); 5210MHz for 802.11 ac/ax80;
Operation Frequency:	5745-5825 MHz for 802.11a/n/ax(HT20); 5755-5795 MHz for 802.11n/ax(HT40); 5775MHz for 802.11 ac/ax80;
Data Rate	802.11a: 6,9,12,18,24,36,48,54Mbps; 802.11n(HT20/HT40): MCS0-MCS15; 802.11ac(VHT20): MCS0-MCS8 802.11ac(VHT40/VHT80): MCS0-MCS9 802.11ax (HE 20/HE 40/HE 80): MCS0~MCS11
Type of Modulation:	OFDM with BPSK/QPSK/16QAM/64QAM for 802.11a/n OFDM with BPSK/QPSK/16QAM/64QAM/256QAM for 802.11ac OFDMA with BPSK / BPSK_DCM /QPSK /QPSK_DCM /QAM16 /QAM16_DCM /QAM64 /QAM256 /QAM1024 for 802.11ax
Number Of Channel	4 channels for 802.11a/n20/ax20 in the 5180-5240MHz band ; 2 channels for 802.11 n40/ax40 in the 5190-5230MHz band ; 1 channels for 802.11 ac80/ax80 in the 5210MHz band ; 5 channels for 802.11a/n20/ax20 in the 5745-5825MHz band ; 2 channels for 802.11 n40/ax40 in the 5755-5795MHz band ; 1 channels for 802.11 ac80/ax80 in the 5775MHz band
Antenna installation:	Internal antenna
Antenna Gain:	WIFI(5.1GHz): Antenna A: 3.48 dBi, Antenna B: 1.39 dBi WIFI(5.8GHz): Antenna A: 2.01 dBi, Antenna B: 3.31 dBi Remark: <input checked="" type="checkbox"/> The antenna gain of the product comes from the antenna report provided by the customer, and the test data is affected by the customer information. <input type="checkbox"/> The antenna gain of the product is provided by the customer, and the test data is affected by the customer information.
Ratings:	DC 19V from adapter or DC 11.55V from battery or DC 11.4V from battery
Battery:	Battery 1: DC 11.4V, 5500mAh, 62.7Wh Battery 2: DC 11.55V, 4780mAh, 55.21Wh
Adapter Information:	MODEL: BSY065T1903423 D INPUT: 100-240V 50/60Hz, 1.5A OUTPUT: DC 19.0V 3.42A 64.98W

4.2 Test Setup Configuration

See test photographs attached in *EUT TEST SETUP PHOTOGRAPHS* for the actual connections between Product and support equipment.

Conducted Emission:

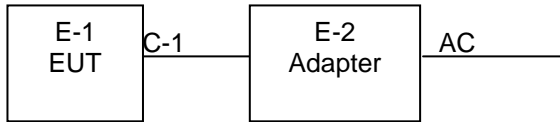

Radiated Spurious Emission

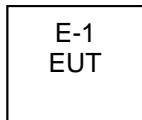

4.3 Support Equipment

No.	Device Type	Brand	Model	Series No.	Note
E-1	Laptop	Acer	Aspire 3 A325-51	N/A	EUT
E-2	ADAPTER	N/A	BSY065T19034 23 D	N/A	Auxiliary

Item	Shielded Type	Ferrite Core	Length	Note
C-1	N/A	N/A	3M	DC cable unshielded

Notes:

- All the equipment/cables were placed in the worst-case configuration to maximize the emission during the test.
- Grounding was established in accordance with the manufacturer's requirements and conditions for the intended use.

4.4 Channel List

5.1G

802.11a/n/ac/ax(20MHz) Carrier Frequency Channel							
Channel	Frequency (MHz)	Channel	Frequency (MHz)	Channel	Frequency (MHz)	Channel	Frequency (MHz)
36	5180	44	5220	-	-	-	-
40	5200	48	5240	-	-	-	-

802.11n /ac/ax(40MHz) Carrier Frequency Channel							
Channel	Frequency (MHz)	Channel	Frequency (MHz)	Channel	Frequency (MHz)	Channel	Frequency (MHz)
38	5190	-	-	-	-	-	-
46	5230	-	-	-	-	-	-

802.11ac/ax (80MHz) Carrier Frequency Channel	
Channel	Frequency (MHz)
42	5210

5.8G

802.11a/n/ac/ax(20 MHz) Carrier Frequency Channel							
Channel	Frequency (MHz)	Channel	Frequency (MHz)	Channel	Frequency (MHz)	Channel	Frequency (MHz)
149	5745	153	5765	157	5785	161	5805
165	5825	-	-	-	-	-	-

802.11n/ac/ax 40MHz Carrier Frequency Channel					
Channel	Frequency (MHz)	Channel	Frequency (MHz)	Channel	Frequency (MHz)
151	5755	159	5795	-	-

802.11 ac/ax 80MHz Carrier Frequency Channel	
Channel	Frequency (MHz)
155	5775

4.5 Test Mode

To investigate the maximum EMI emission characteristics generates from EUT, the test system was pre-scanning tested base on the consideration of following EUT operation mode or test configuration mode which possible have effect on EMI emission level. Each of these EUT operation mode(s) or test configuration mode(s) mentioned above was evaluated respectively.

Pretest Mode	Description
Mode 1	802.11a / n/ ac 20/ ax 20 CH36/ CH40/ CH 48 802.11a /n/ ac 20/ ax 20 CH149/ CH157/ CH 165
Mode 2	802.11n/ ac40/ ax 40 CH38/ CH 46 802.11n/ ac40/ ax 40 CH 151 / CH 159
Mode 3	802.11 ac80/ ax80 CH 42/CH 155
Mode 4	Link mode (Conducted emission & Radiated emission)

Note:

- (1) The measurements are performed at all Bit Rate of Transmitter, the worst data was reported.
- (2) We're testing antenna A data.

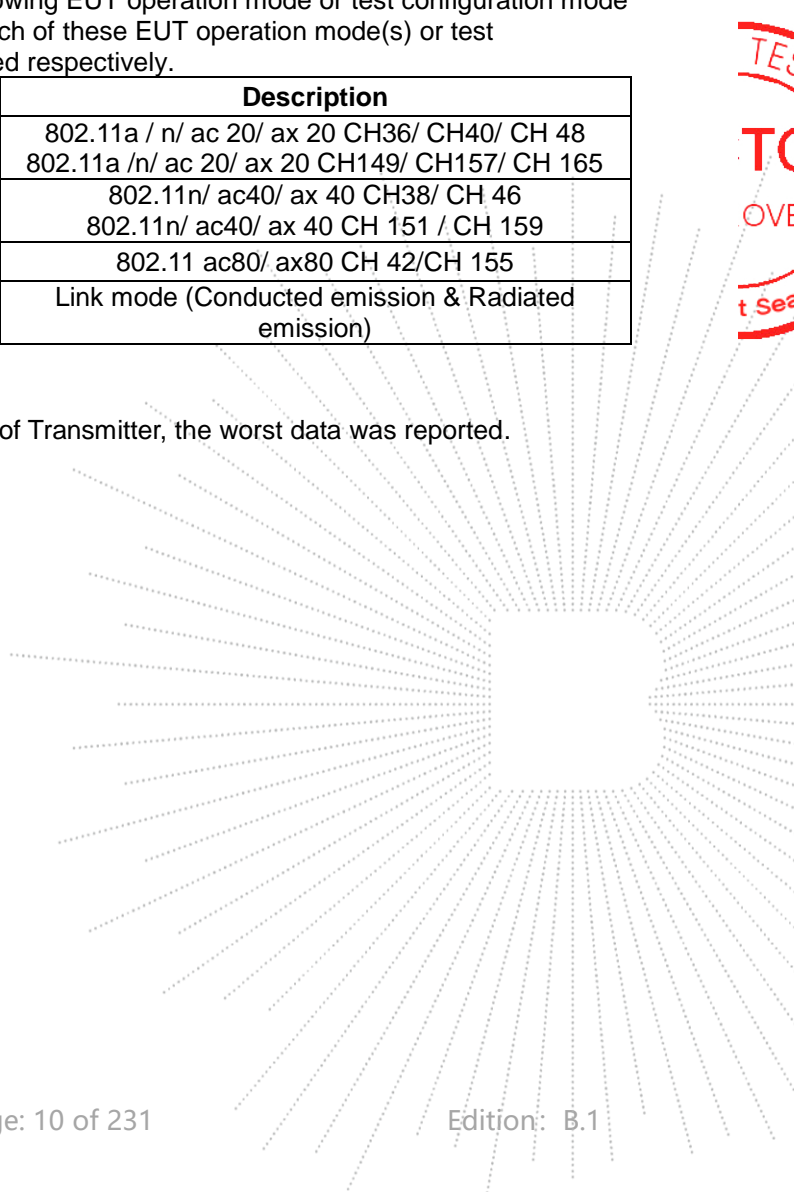

TEST
 TO
 OVER
 t See

4.6 Table Of Parameters Of Text Software Setting

During testing channel & power controlling software provided by the customer was used to control the operating channel as well as the output power level. The RF output power selection is for the setting of RF output power expected by the customer and is going to be fixed on the firmware of the final end product power parameters

Test software Version	phwfw02372_22.10.0.7tools		
Parameters	DEF	DEF	DEF

4.7 Antenna

5.1G

1)For power spectral density(PSD) measurements,
 Array Gain= $10\log(NANT/NSS)$ dB= $10\log(2/1)$ =3.01dB,
 So the directional gain for PSD is 6.49 dBi

2)For power measurements,

The Array gain=0 dB for $NANT \leq 4$,

So the directional gain for Power measurements is 3.48 dBi

Antenna	Brand	Model Name	Antenna Type	Gain (dBi)	NOTE
A	N/A	N/A	Internal antenna	3.48	N/A
B	N/A	N/A	Internal antenna	1.39	N/A

5.8G

1)For power spectral density(PSD) measurements,
 Array Gain= $10\log(NANT/NSS)$ dB= $10\log(2/1)$ =3.01dB,
 So the directional gain for PSD is 6.32 dB

2)For power measurements,

The Array gain=0 dB for $NANT \leq 4$,

So the directional gain for Power measurements is 3.31 dBi

Antenna	Brand	Model Name	Antenna Type	Gain (dBi)	NOTE
A	N/A	N/A	Internal antenna	2.01	N/A
B	N/A	N/A	Internal antenna	3.31	N/A

Directional gain may be calculated by using the formulas applicable to equal gain antennas with GANT set equal to the gain of the antenna having the highest gain.

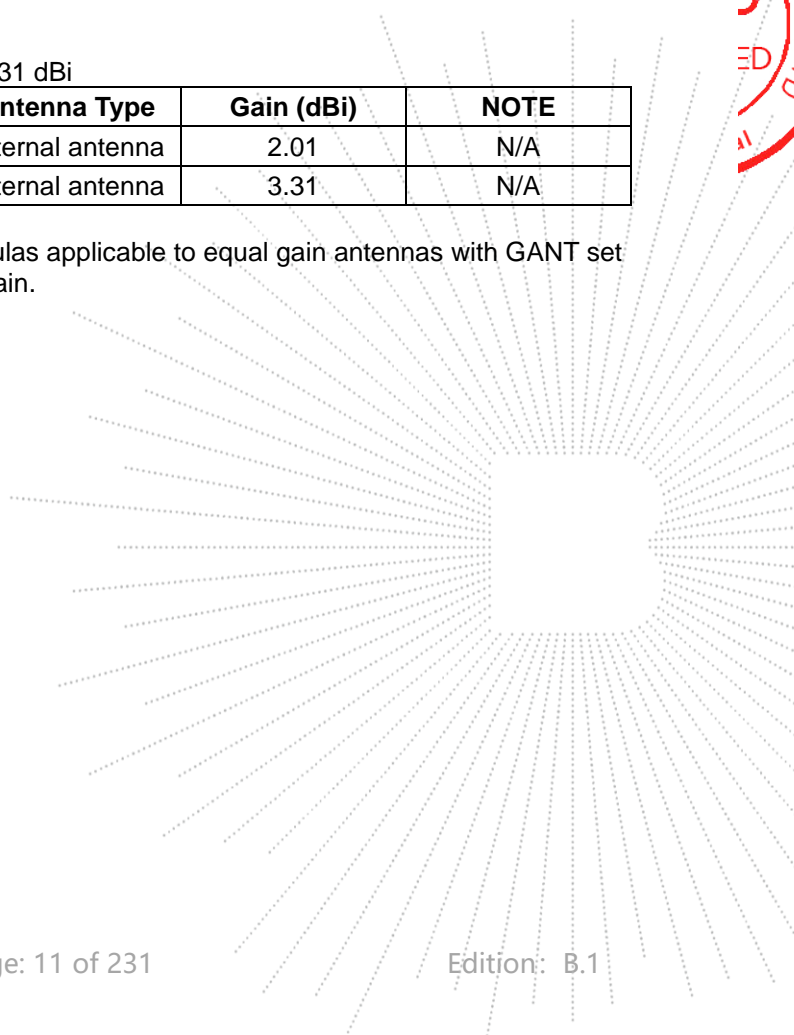

5. Test Facility And Test Instrument Used

5.1 Test Facility

All measurement facilities used to collect the measurement data are located at Shenzhen BCTC Testing Co., Ltd. Address: 1-2/F., Building B, Pengzhou Industrial Park, No.158, Fuyuan 1st Road, Zhancheng, Fuhai Subdistrict, Bao'an District, Shenzhen, Guangdong, China. The site and apparatus are constructed in conformance with the requirements of ANSI C63.4 and CISPR 16-1-1 other equivalent standards.

FCC Test Firm Registration Number: 712850

A2LA certificate registration number is: CN1212

ISED Registered No.: 23583

ISED CAB identifier: CN0017

5.2 Test Instrument Used

Conducted Emissions Test					
Equipment	Manufacturer	Model#	Serial#	Last Cal.	Next Cal.
Receiver	R&S	ESR3	102075	May 15, 2023	May 14, 2024
LISN	R&S	ENV216	101375	May 15, 2023	May 14, 2024
Software	Frad	EZ-EMC	EMC-CON 3A1	\	\
Pulse limiter	Schwarzbeck	VTSD9561-F	01323	Sept. 22, 2023	Sept. 21, 2024

RF Conducted Test					
Equipment	Manufacturer	Model#	Serial#	Last Cal.	Next Cal.
Power meter	Keysight	E4419	\	May 15, 2023	May 14, 2024
Power Sensor (AV)	Keysight	E9300A	\	May 15, 2023	May 14, 2024
Signal Analyzer20kHz-26.5GHz	Keysight	N9020A	MY49100060	May 15, 2023	May 14, 2024
Spectrum Analyzer9kHz-40GHz	R&S	FSP40	100363	May 15, 2023	May 14, 2024
Radio frequency control box	MAIWEI	MW100-RFC B	\	\	\
Software	MAIWEI	MTS 8310	\	\	\

Radiated Emissions Test (966 Chamber01)					
Equipment	Manufacturer	Model#	Serial#	Last Cal.	Next Cal.
966 chamber	ChengYu	966 Room	966	May 15, 2023	May 14, 2026
Receiver	R&S	ESR3	102075	May 15, 2023	May 14, 2024
Receiver	R&S	ESRP	101154	May 15, 2023	May 14, 2024
Amplifier	Schwarzbeck	BBV9744	9744-0037	May 15, 2023	May 14, 2024
TRILOG Broadband Antenna	Schwarzbeck	VULB9163	942	May 29, 2023	May 28, 2024
Loop Antenna(9KHz -30MHz)	Schwarzbeck	FMZB1519B	00014	May 31, 2023	May 30, 2024
Amplifier	SKET	LAPA_01G18 G-45dB	SK202104090 1	May 15, 2023	May 14, 2024
Horn Antenna	Schwarzbeck	BBHA9120D	1541	May 31, 2023	May 30, 2024
Amplifier(18G Hz-40GHz)	MITEQ	TTA1840-35-HG	2034381	May 15, 2023	May 14, 2024
Horn Antenna(18G Hz-40GHz)	Schwarzbeck	BBHA9170	00822	May 31, 2023	May 30, 2024
Spectrum Analyzer9kHz-40GHz	R&S	FSP40	100363	May 15, 2023	May 14, 2024
Software	Frad	EZ-EMC	FA-03A2 RE	\	\

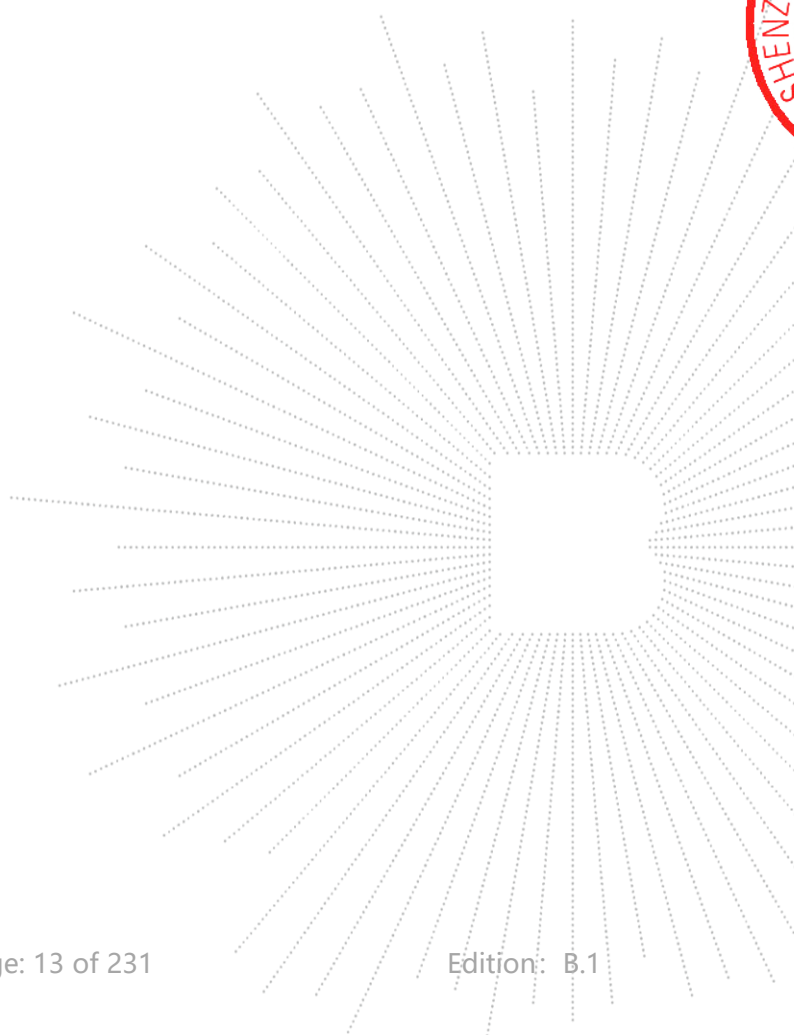
6. Conducted Emissions

6.1 Block Diagram Of Test Setup

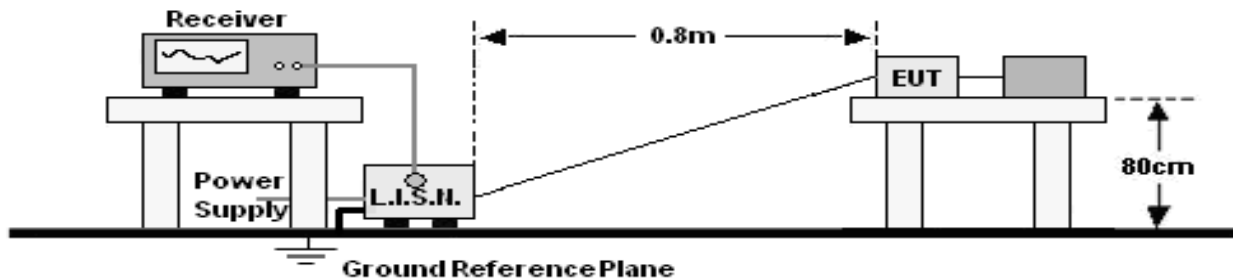

6.2 Limit

Frequency (MHz)	Limit (dBuV)	
	Quas-peak	Average
0.15 -0.5	66 - 56 *	56 - 46 *
0.50 -5.0	56.00	46.00
5.0 -30.0	60.00	50.00

Notes:
 1. *Decreasing linearly with logarithm of frequency.
 2. The lower limit shall apply at the transition frequencies.

6.3 Test Procedure

Receiver Parameters	Setting
Attenuation	10 dB
Start Frequency	0.15 MHz
Stop Frequency	30 MHz
IF Bandwidth	9 kHz

- The Product was placed on a nonconductive table 0.8 m above the horizontal ground reference plane, and 0.4 m from the vertical ground reference plane, and connected to the main through Line Impedance Stability Network (L.I.S.N).
- The RBW of the receiver was set at 9 kHz in 150 kHz ~ 30MHz with Peak and AVG detector in Max Hold mode. Run the receiver's pre-scan to record the maximum disturbance generated from Product in all power lines in the full band.
- For each frequency whose maximum record was higher or close to limit, measure its QP and AVG values and record.

6.4 EUT Operating Conditions

The EUT was configured for testing in a typical fashion (as a customer would normally use it). The EUT has been programmed to continuously transmit during test. This operating condition was tested and used to collect the included data.

6.5 Test Result

Temperature:	26 °C	Relative Humidity:	54%
Pressure:	101KPa	Phase :	L
Test Mode:	Mode 1(battery 1)	Test Voltage :	AC120V/60Hz

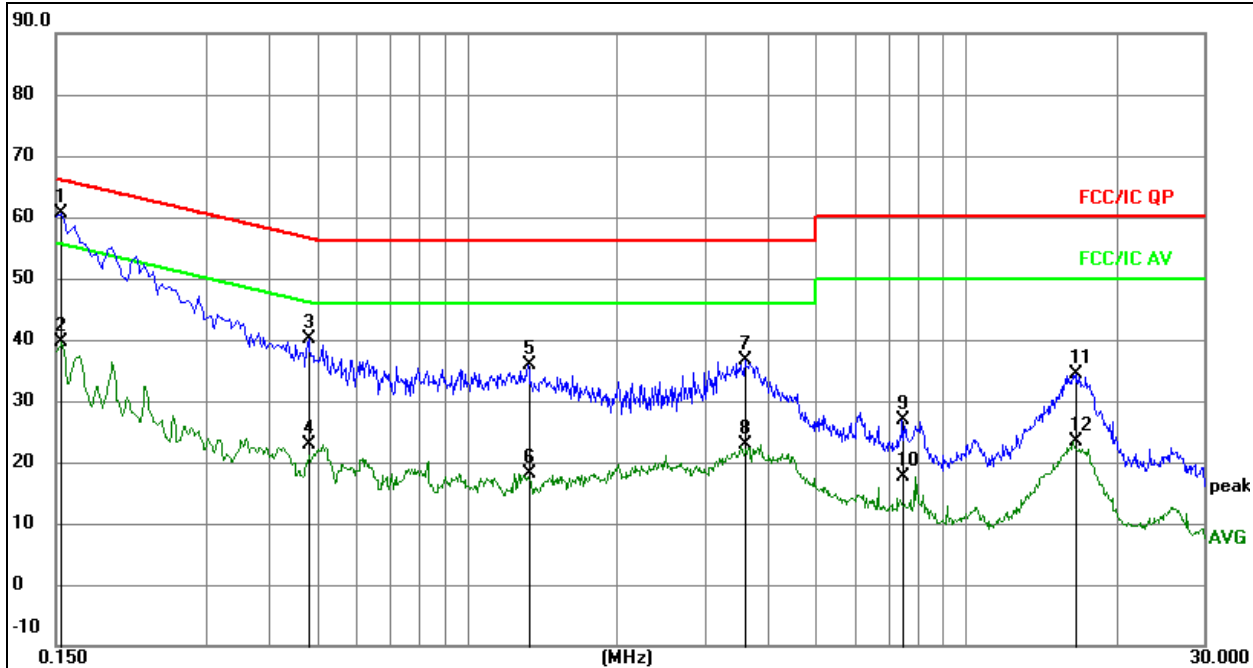

Remark:

1. All readings are Quasi-Peak and Average values.
2. Factor = Insertion Loss + Cable Loss.
3. Measurement = Reading Level + Correct Factor
4. Over = Measurement - Limit

No.	Mk.	Freq. MHz	Reading Level	Correct Factor dB	Measure- ment dBuV	Limit dBuV	Over dB	Detector
1	*	0.1539	40.96	19.74	60.70	65.79	-5.09	QP
2		0.1539	19.95	19.74	39.69	55.79	-16.10	AVG
3		0.4812	20.17	19.84	40.01	56.32	-16.31	QP
4		0.4812	2.95	19.84	22.79	46.32	-23.53	AVG
5		1.3238	15.85	19.95	35.80	56.00	-20.20	QP
6		1.3238	-1.76	19.95	18.19	46.00	-27.81	AVG
7		3.6034	16.21	20.52	36.73	56.00	-19.27	QP
8		3.6034	2.35	20.52	22.87	46.00	-23.13	AVG
9		7.4465	6.91	19.95	26.86	60.00	-33.14	QP
10		7.4465	-2.35	19.95	17.60	50.00	-32.40	AVG
11		16.5732	14.51	19.91	34.42	60.00	-25.58	QP
12		16.5732	3.45	19.91	23.36	50.00	-26.64	AVG

Temperature:	26 °C	Relative Humidity:	54%
Pressure:	101KPa	Phase :	N
Test Mode:	Mode 1(battery 1)	Test Voltage :	AC120V/60Hz

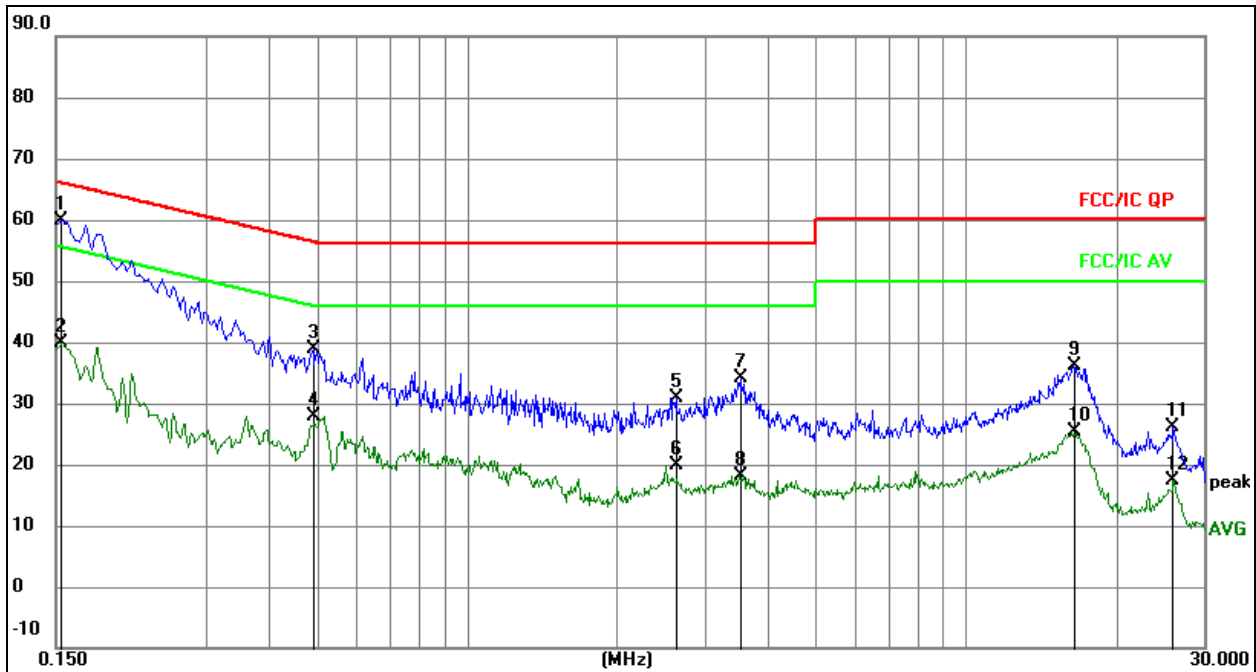
Remark:

1. All readings are Quasi-Peak and Average values.
2. Factor = Insertion Loss + Cable Loss.
3. Measurement = Reading Level + Correct Factor
4. Over = Measurement - Limit

No.	Mk.	Freq. MHz	Reading Level	Correct Factor dB	Measure- ment dBuV	Limit dBuV	Over dB	Detector
1	*	0.1539	40.17	19.74	59.91	65.79	-5.88	QP
2		0.1539	20.18	19.74	39.92	55.79	-15.87	AVG
3		0.4915	19.09	19.84	38.93	56.14	-17.21	QP
4		0.4915	8.06	19.84	27.90	46.14	-18.24	AVG
5		2.6221	10.67	20.17	30.84	56.00	-25.16	QP
6		2.6221	-0.24	20.17	19.93	46.00	-26.07	AVG
7		3.5278	13.52	20.49	34.01	56.00	-21.99	QP
8		3.5278	-2.26	20.49	18.23	46.00	-27.77	AVG
9		16.3985	16.13	19.91	36.04	60.00	-23.96	QP
10		16.3985	5.38	19.91	25.29	50.00	-24.71	AVG
11		26.0012	6.26	19.99	26.25	60.00	-33.75	QP
12		26.0012	-2.63	19.99	17.36	50.00	-32.64	AVG

Temperature:	26 °C	Relative Humidity:	54%
Pressure:	101KPa	Phase :	L
Test Mode:	Mode 1(battery 2)	Test Voltage :	AC120V/60Hz

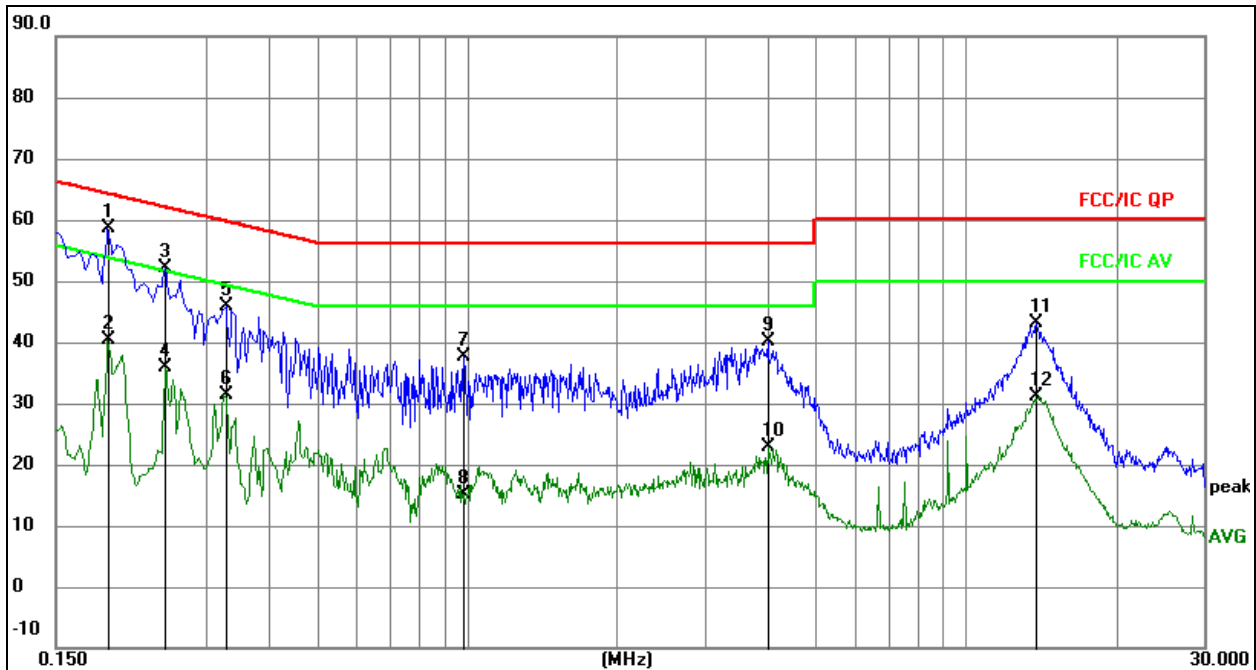
Remark:

1. All readings are Quasi-Peak and Average values.
2. Factor = Insertion Loss + Cable Loss.
3. Measurement = Reading Level + Correct Factor
4. Over = Measurement - Limit

No.	Mk.	Freq. MHz	Reading Level	Correct Factor dB	Measure- ment dBuV	Limit dBuV	Over dB	Detector
1	*	0.1904	38.85	19.81	58.66	64.02	-5.36	QP
2		0.1904	20.65	19.81	40.46	54.02	-13.56	AVG
3		0.2481	32.37	19.83	52.20	61.82	-9.62	QP
4		0.2481	16.04	19.83	35.87	51.82	-15.95	AVG
5		0.3286	26.05	19.83	45.88	59.49	-13.61	QP
6		0.3286	11.53	19.83	31.36	49.49	-18.13	AVG
7		0.9839	17.76	19.94	37.70	56.00	-18.30	QP
8		0.9839	-4.76	19.94	15.18	46.00	-30.82	AVG
9		4.0062	19.42	20.66	40.08	56.00	-15.92	QP
10		4.0062	2.17	20.66	22.83	46.00	-23.17	AVG
11		13.8411	23.19	19.88	43.07	60.00	-16.93	QP
12		13.8411	11.17	19.88	31.05	50.00	-18.95	AVG

Temperature:	26 °C	Relative Humidity:	54%
Pressure:	101KPa	Phase :	N
Test Mode:	Mode 1(battery 2)	Test Voltage :	AC120V/60Hz

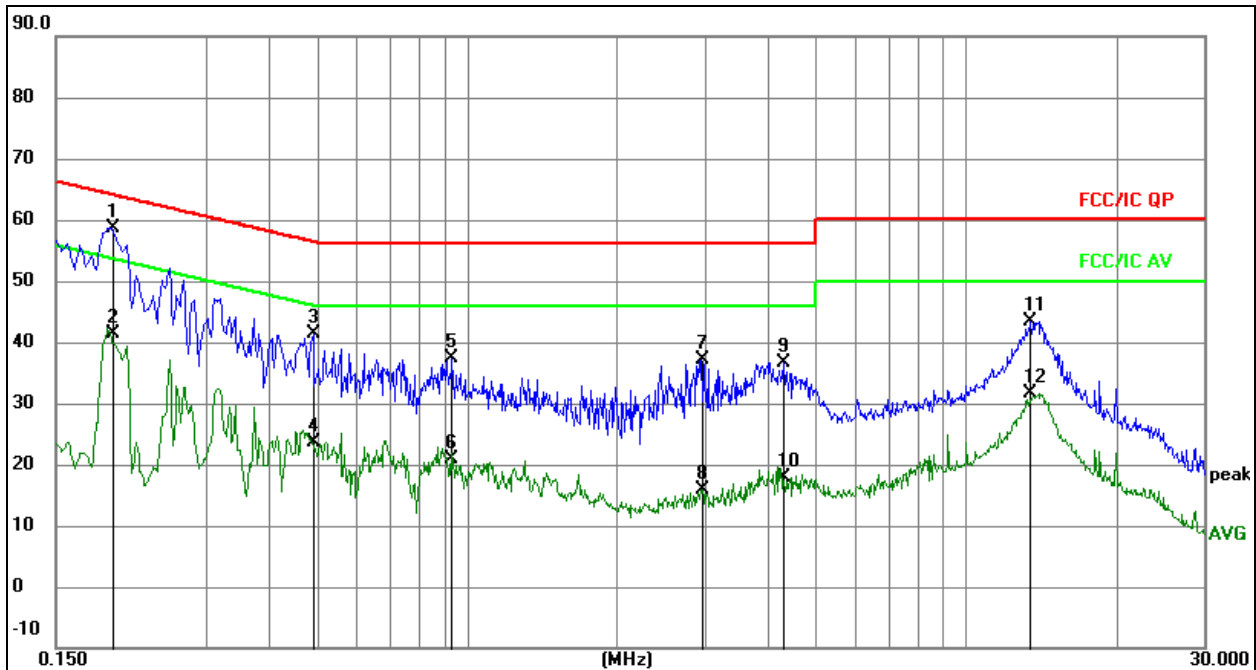
Remark:

1. All readings are Quasi-Peak and Average values.
2. Factor = Insertion Loss + Cable Loss.
3. Measurement = Reading Level + Correct Factor
4. Over = Measurement - Limit

No.	Mk.	Freq. MHz	Reading Level	Correct Factor dB	Measure- ment dBuV	Limit dBuV	Over dB	Detector
1	*	0.1945	38.89	19.82	58.71	63.84	-5.13	QP
2		0.1945	21.53	19.82	41.35	53.84	-12.49	AVG
3		0.4915	21.57	19.84	41.41	56.14	-14.73	QP
4		0.4915	3.74	19.84	23.58	46.14	-22.56	AVG
5		0.9331	17.37	19.93	37.30	56.00	-18.70	QP
6		0.9331	1.02	19.93	20.95	46.00	-25.05	AVG
7		2.9463	16.81	20.29	37.10	56.00	-18.90	QP
8		2.9463	-4.45	20.29	15.84	46.00	-30.16	AVG
9		4.3146	16.00	20.59	36.59	56.00	-19.41	QP
10		4.3146	-2.65	20.59	17.94	46.00	-28.06	AVG
11		13.4792	23.53	19.88	43.41	60.00	-16.59	QP
12		13.4792	11.74	19.88	31.62	50.00	-18.38	AVG

7. Radiated Emissions

7.1 Block Diagram Of Test Setup

(A) Radiated Emission Test-Up Frequency Below 30MHz

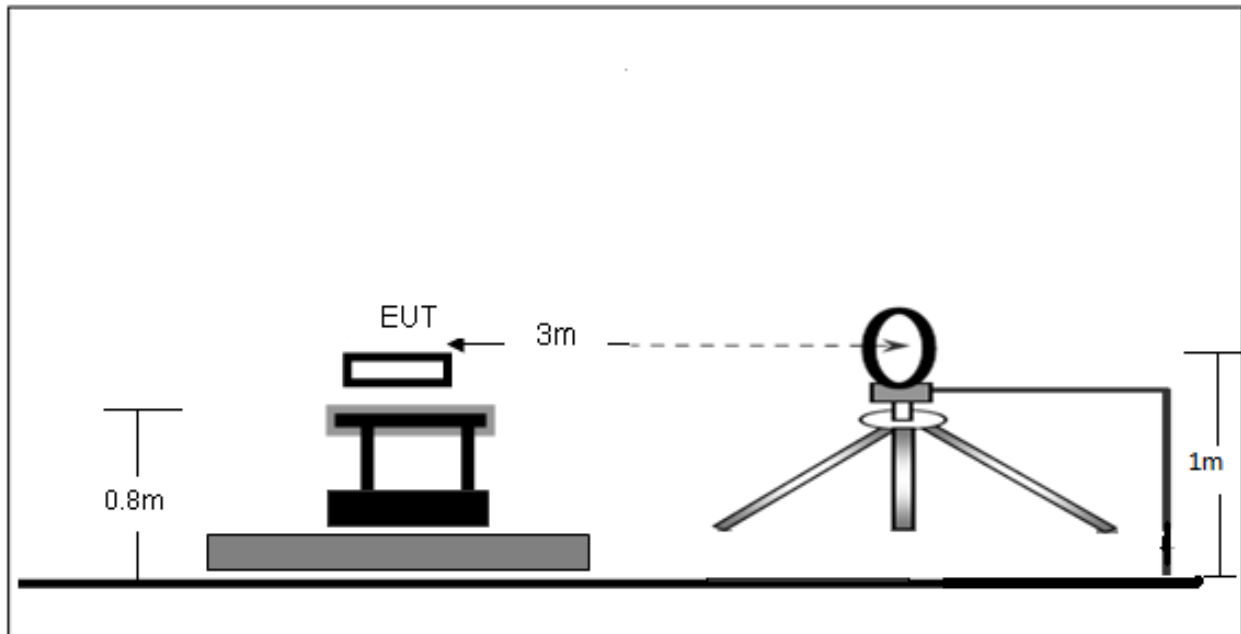

(B) Radiated Emission Test-Up Frequency 30MHz~1GHz

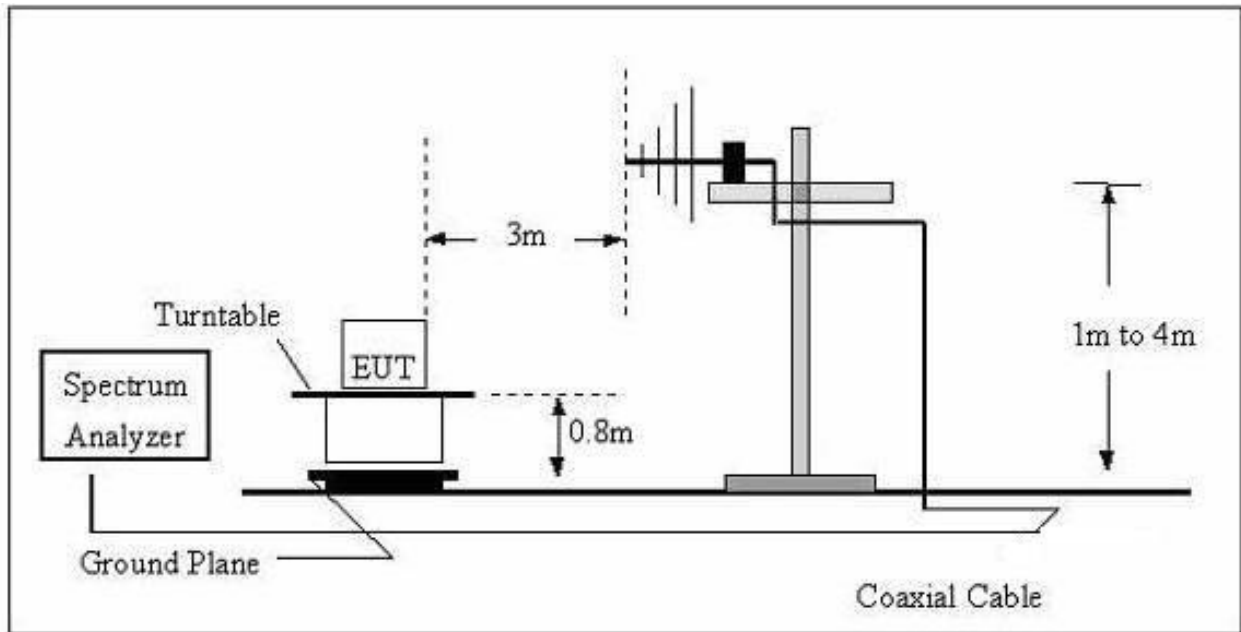

(C) Radiated Emission Test-Up Frequency Above 1GHz

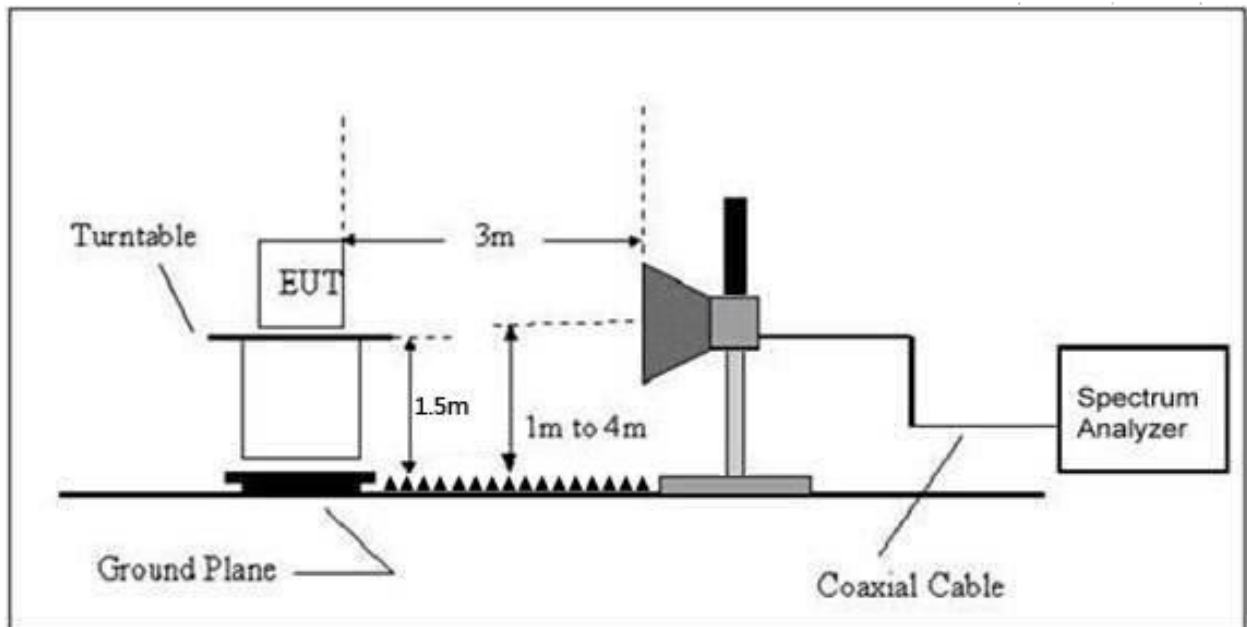

7.2 Limit

20dBc in any 100 kHz bandwidth outside the operating frequency band. In case the emission fall within the restricted band specified on 15.205(a), then the 15.209(a) limit in the table below has to be followed.

Frequency (MHz)	Field Strength uV/m	Distance (m)	Field Strength Limit at 3m Distance	
			uV/m	dBuV/m
0.009 ~ 0.490	2400/F(kHz)	300	10000 * 2400/F(kHz)	$20\log^{(2400/F(kHz))} + 80$
0.490 ~ 1.705	24000/F(kHz)	30	100 * 24000/F(kHz)	$20\log^{(24000/F(kHz))} + 40$
1.705 ~ 30	30	30	100 * 30	$20\log^{(30)} + 40$
30 ~ 88	100	3	100	$20\log^{(100)}$
88 ~ 216	150	3	150	$20\log^{(150)}$
216 ~ 960	200	3	200	$20\log^{(200)}$
Above 960	500	3	500	$20\log^{(500)}$

Limits Of Radiated Emission Measurement (Above 1000MHz)

Frequency (MHz)	Limit (dBuV/m) (at 3M)	
	Peak	Average
Above 1000	74	54

Notes:

- (1) The limit for radiated test was performed according to FCC PART 15C.
- (2) The tighter limit applies at the band edges.
- (3) Emission level (dBuV/m) = $20\log$ Emission level (uV/m).

BCTC
 3C
 PPR
 Report

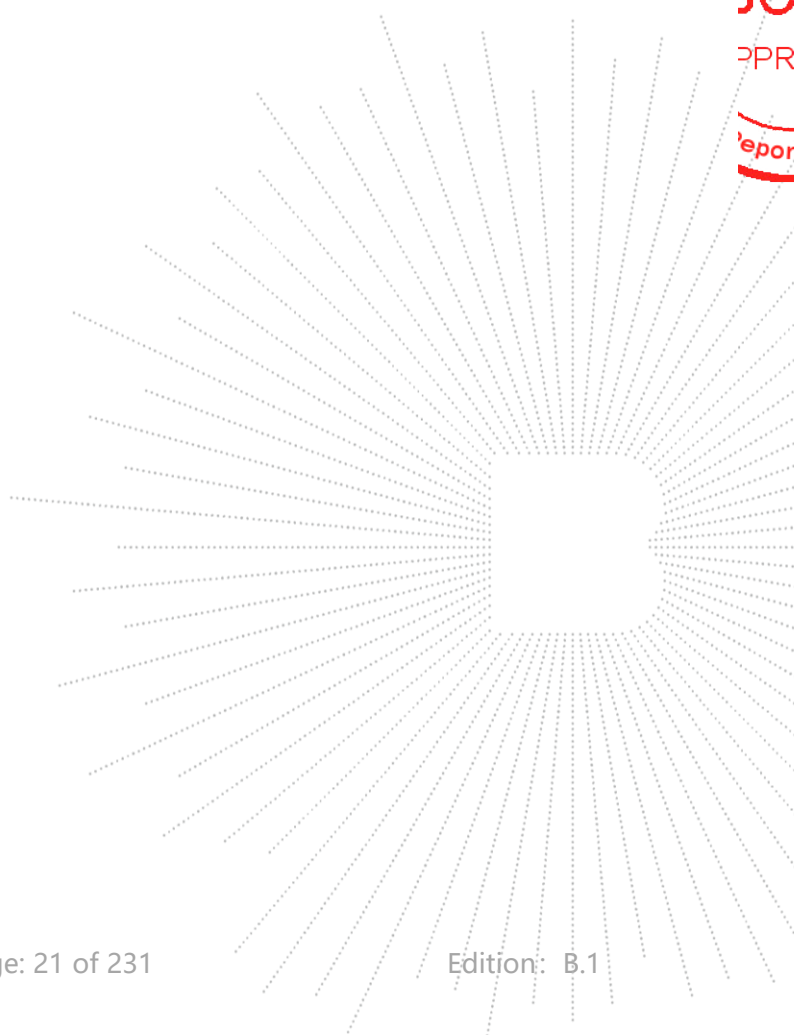

7.3 Test Procedure

The test site semi-anechoic chamber has met the requirement of NSA tolerance 4 dB according to the standards: ANSI C63.10-2013. The test distance is 3m. The setup is according to the requirements in Section 13.1.4.1 of ANSI C63.10-2013 and CAN/CSA-CEI/IEC CISPR 22.

This test is required for any spurious emission that falls in a Restricted Band, as defined in Section 15.205. It must be performed with the highest gain of each type of antenna proposed for use with the EUT.

Use the following spectrum analyzer settings:

Spectrum Parameter	Setting
Attenuation	Auto
Start Frequency	1000 MHz
Stop Frequency	10th carrier harmonic
RB / VB (emission in restricted band)	1 MHz / 1 MHz for Peak, 1 MHz / 10Hz for Average

Receiver Parameter	Setting
Attenuation	Auto
Start ~ Stop Frequency	9kHz~150kHz / RB 200Hz for QP
Start ~ Stop Frequency	150kHz~30MHz / RB 9kHz for QP
Start ~ Stop Frequency	30MHz~1000MHz / RB 120kHz for QP

- The measuring distance of at 3 m shall be used for measurements at frequency up to 1GHz. For frequencies above 1GHz, any suitable measuring distance may be used.
- The EUT was placed on the top of a rotating table 0.8 m for below 1GHz and 1.5m for above 1GHz the ground at a 3 meter. The table was rotated 360 degrees to determine the position of the highest radiation.
- The height of the equipment or of the substitution antenna shall be 0.8 m for below 1GHz and 1.5m for above 1GHz; the height of the test antenna shall vary between 1 m to 4 m. Both horizontal and vertical polarizations of the antenna are set to make the measurement.
- The initial step in collecting conducted emission data is a spectrum analyzer peak detector mode pre-scanning the measurement frequency range. Significant peaks are then marked and then Quasi Peak detector mode re-measured.
- If the Peak Mode measured value compliance with and lower than Quasi Peak Mode Limit, the EUT shall be deemed to meet QP Limits and then no additional QP Mode measurement performed.
- For the actual test configuration, please refer to the related Item –EUT Test Photos.

Note:

Both horizontal and vertical antenna polarities were tested and performed pretest to three orthogonal axis. The worst case emissions were reported

During the radiated emission test, the Spectrum Analyzer was set with the following configurations:

Frequency Band (MHz)	Function	Resolution bandwidth	Video Bandwidth
30 to 1000	QP	120 kHz	300 kHz
Above 1000	Peak	1 MHz	1 MHz
	Average	1 MHz	10 Hz

Note: for the frequency ranges below 30 MHz, a narrower RBW is used for these ranges but the measured value should add a RBW correction factor (RBWCF) where $RBWCF [dB] = 10 \cdot \lg(100 [kHz] / \text{narrower RBW [kHz]})$. , the narrower RBW is 1 kHz and RBWCF is 20 dB for the frequency 9 kHz to 150 kHz, and the narrower RBW is 10 kHz and RBWCF is 10 dB for the frequency 150 kHz to 30 MHz.

7.4 EUT Operating Conditions

The EUT was configured for testing in a typical fashion (as a customer would normally use it). The EUT has been programmed to continuously transmit during test. This operating condition was tested and used to collect the included data.

7.5 Test Result

Below 30MHz

Temperature:	26°C	Relative Humidity:	24%
Pressure:	101KPa	Test Voltage :	DC 11.4V/DC 11.55V
Test Mode:	Mode 6	Polarization :	--

Freq. (MHz)	Reading (dBuV/m)	Limit (dBuV/m)	Margin (dB)	State P/F
--	--	--	--	PASS
--	--	--	--	PASS

Note:

The amplitude of spurious emissions which are attenuated by more than 20dB below the permissible value has no need to be reported.

Distance extrapolation factor = $40 \log(\text{specific distance/test distance})(\text{dB})$;

Limit line = specific limits(dBuv) + distance extrapolation factor.

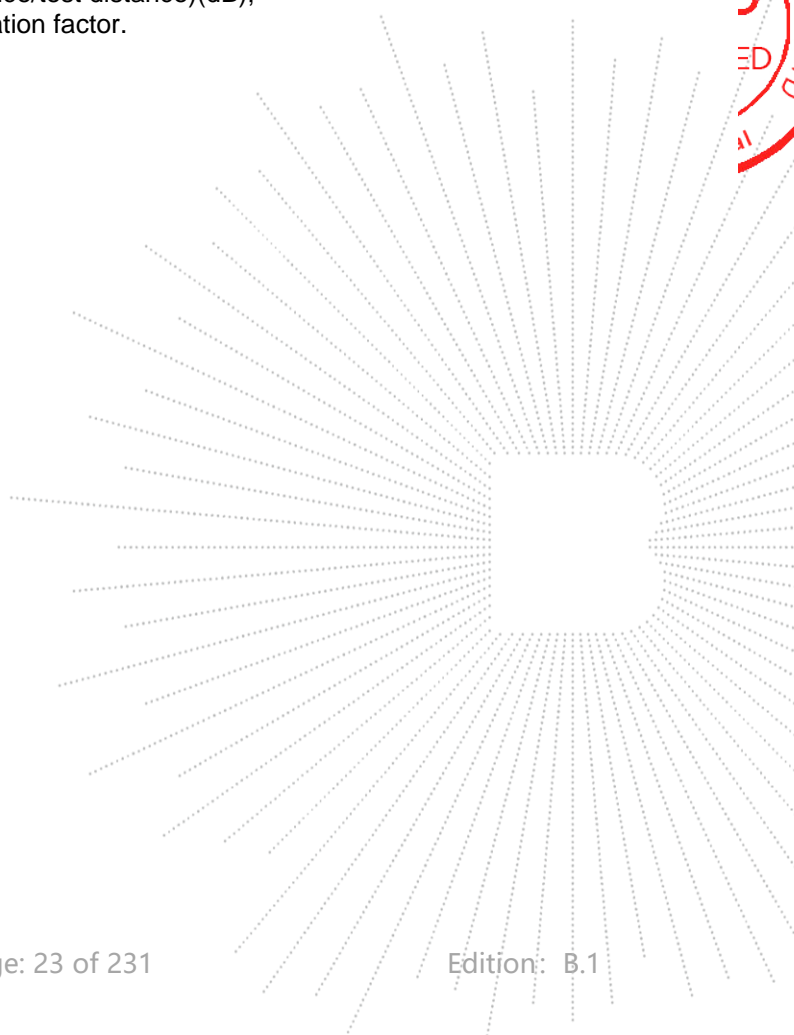

Temperature:	26 °C	Relative Humidity:	54%
Pressure:	101KPa	Phase :	Horizontal
Test Mode:	Mode 3	Test Voltage :	DC 11.4V(battery 1)

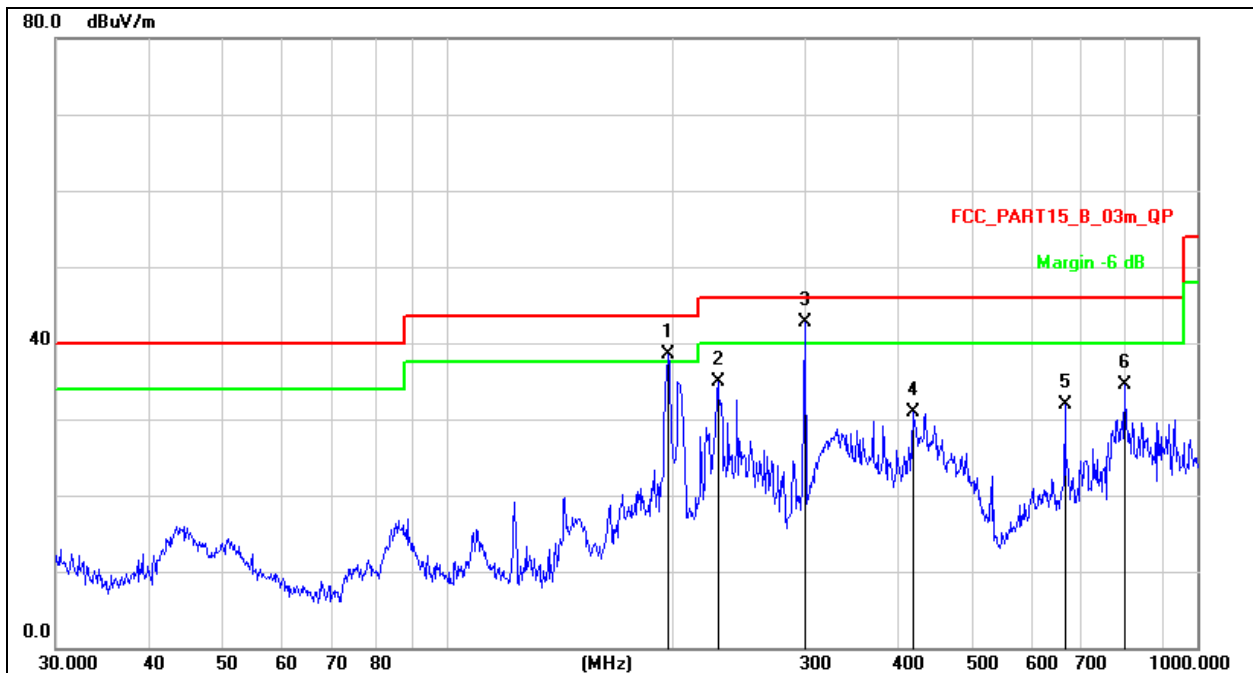
Remark:

1. Factor = Antenna Factor + Cable Loss – Pre-amplifier.
2. Measurement = Reading Level + Correct Factor
3. Over = Measurement - Limit

No.	Mk.	Freq.	Reading Level	Correct Factor	Measurement	Limit	Over	Detector
		MHz	dBuV	dB	dBuV/m	dB/m	dB	
1	!	197.2000	54.39	-15.93	38.46	43.50	-5.04	QP
2		229.2931	49.79	-14.88	34.91	46.00	-11.09	QP
3	*	299.3158	55.95	-13.25	42.70	46.00	-3.30	QP
4		417.6409	41.40	-10.49	30.91	46.00	-15.09	QP
5		665.8034	37.85	-6.02	31.83	46.00	-14.17	QP
6		798.9796	38.83	-4.41	34.42	46.00	-11.58	QP

Temperature:	26 °C	Relative Humidity:	54%
Pressure:	101KPa	Phase :	Vertical
Test Mode:	Mode 3	Test Voltage :	DC 11.4V(battery 1)

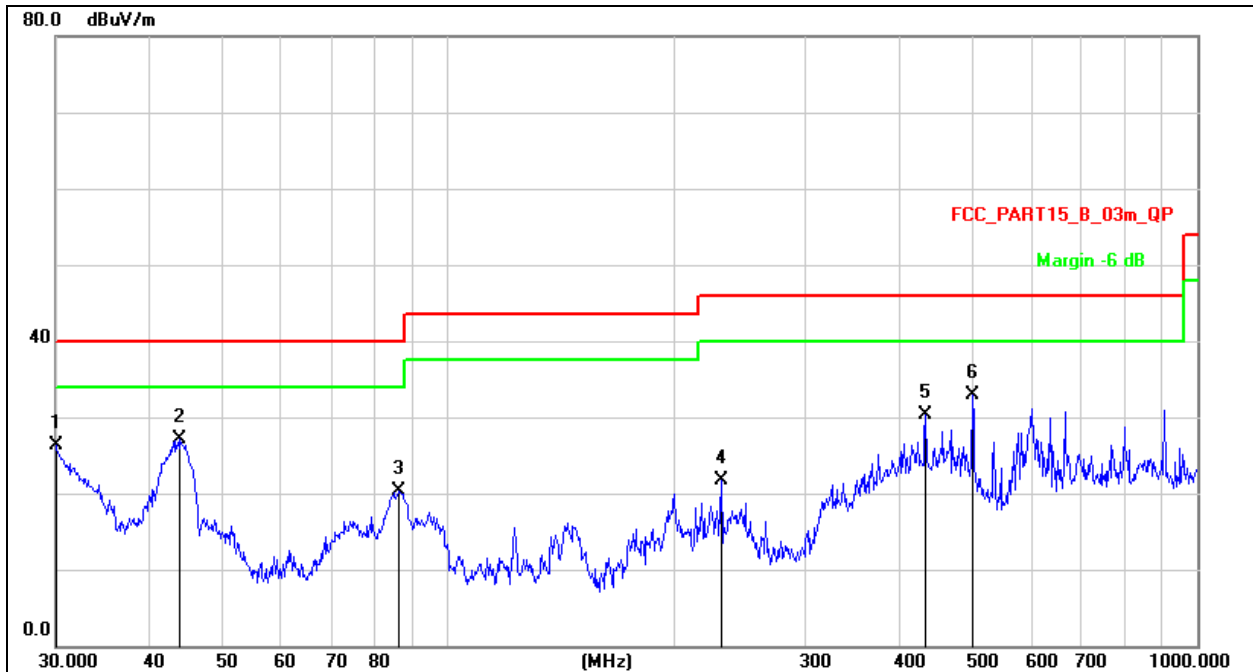

Remark:
 1. Factor = Antenna Factor + Cable Loss – Pre-amplifier.
 2. Measurement = Reading Level + Correct Factor
 3. Over = Measurement - Limit

No.	Mk.	Freq. MHz	Reading Level dBuV	Correct Factor dB	Measure- ment dBuV/m	Limit dB/m	Over dB	Detector
1		30.0000	42.91	-16.65	26.26	40.00	-13.74	QP
2	*	43.9658	41.50	-14.39	27.11	40.00	-12.89	QP
3		86.2001	38.53	-18.29	20.24	40.00	-19.76	QP
4		231.7179	36.54	-14.81	21.73	46.00	-24.27	QP
5		434.0651	40.49	-10.17	30.32	46.00	-15.68	QP
6		501.1790	41.64	-8.65	32.99	46.00	-13.01	QP

SHENZHEN

Temperature:	26 °C	Relative Humidity:	54%
Pressure:	101KPa	Phase :	Horizontal
Test Mode:	Mode 3	Test Voltage :	DC 11.55V(battery 2)

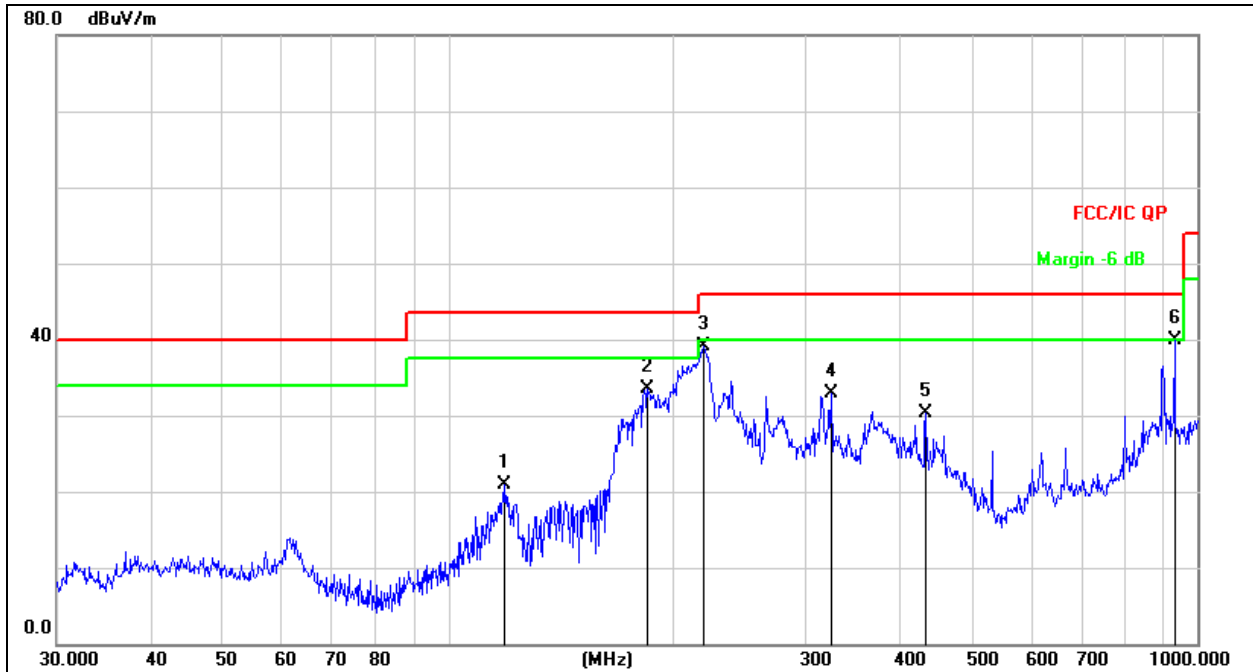
Remark:

1. Factor = Antenna Factor + Cable Loss – Pre-amplifier.
2. Measurement = Reading Level + Correct Factor
3. Over = Measurement - Limit

No.	Mk.	Freq.	Reading Level	Correct Factor	Measurement	Limit	Over	Detector
		MHz	dBuV	dB	dBuV/m	dB/m	dB	
1		119.0180	38.21	-17.26	20.95	43.50	-22.55	QP
2		184.4898	50.44	-16.87	33.57	43.50	-9.93	QP
3		219.0753	54.37	-15.17	39.20	46.00	-6.80	QP
4		324.4561	45.24	-12.38	32.86	46.00	-13.14	QP
5		434.0651	40.44	-10.17	30.27	46.00	-15.73	QP
6	*	932.2715	42.85	-3.00	39.85	46.00	-6.15	QP

Temperature:	26 °C	Relative Humidity:	54%
Pressure:	101KPa	Phase :	Vertical
Test Mode:	Mode 3	Test Voltage :	DC 11.55V(battery 2)

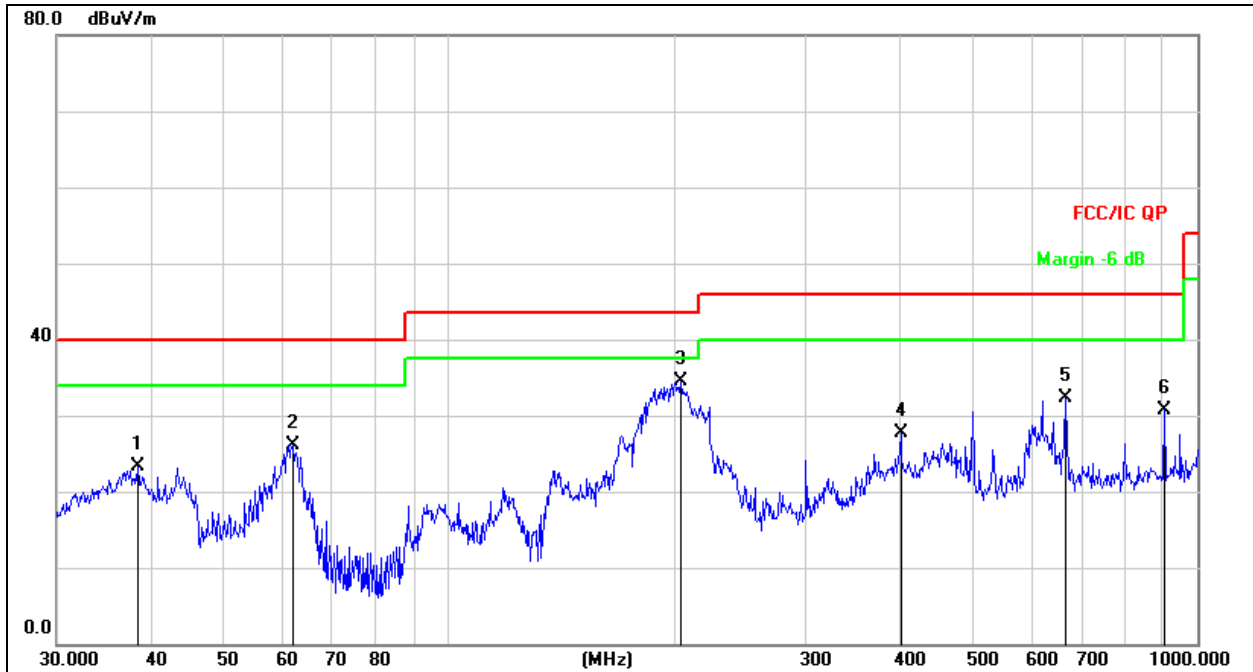

- Remark:
1. Factor = Antenna Factor + Cable Loss – Pre-amplifier.
 2. Measurement = Reading Level + Correct Factor
 3. Over = Measurement - Limit

No.	Mk.	Freq.	Reading Level	Correct Factor	Measurement	Limit	Over	Detector
		MHz	dBuV	dB	dBuV/m	dB/m	dB	
1		38.4809	38.26	-15.01	23.25	40.00	-16.75	QP
2		61.9951	41.99	-15.80	26.19	40.00	-13.81	QP
3	*	204.2377	50.08	-15.60	34.48	43.50	-9.02	QP
4		401.8385	38.59	-10.80	27.79	46.00	-18.21	QP
5		665.8035	38.40	-6.02	32.38	46.00	-13.62	QP
6		903.3094	33.86	-3.11	30.75	46.00	-15.25	QP

Battery 1
 Between 1GHz – 40GHz

Test Mode:	TX(5.1G) - 802.11a
------------	--------------------

Polar	Frequency	Reading Level	Correct Factor	Measurement	Limits	Over	Detector Type
(H/V)	(MHz)	(dBuV/m)	(dB)	(dBuV/m)	(dBuV/m)	(dB)	
Low Channel (5180 MHz)-Above 1G							
Vertical	4434.04	70.12	-20.73	49.39	68.20	-18.81	PK
Vertical	4434.04	59.29	-20.73	38.56	54.00	-15.44	AV
Vertical	10360.07	61.64	-9.36	52.28	68.20	-15.92	PK
Vertical	10360.07	49.67	-9.36	40.31	54.00	-13.69	AV
Vertical	15540.13	60.37	-7.84	52.53	74.00	-21.47	PK
Vertical	15540.13	49.84	-7.84	42.00	54.00	-12.00	AV
Horizontal	4434.08	72.26	-20.73	51.53	68.20	-16.67	PK
Horizontal	4434.08	59.88	-20.73	39.15	54.00	-14.85	AV
Horizontal	10360.01	61.05	-9.36	51.69	68.20	-16.51	PK
Horizontal	10360.01	49.84	-9.36	40.48	54.00	-13.52	AV
Horizontal	15540.02	60.27	-7.84	52.43	74.00	-21.57	PK
Horizontal	15540.02	49.57	-7.84	41.73	54.00	-12.27	AV
Middle Channel (5200 MHz)-Above 1G							
Vertical	4592.09	70.48	-20.42	50.06	74.00	-23.94	PK
Vertical	4592.09	59.33	-20.42	38.92	54.00	-15.08	AV
Vertical	10400.01	63.55	-9.30	54.25	68.20	-13.95	PK
Vertical	10400.01	49.09	-9.30	39.79	54.00	-14.21	AV
Vertical	15600.16	62.25	-7.82	54.43	74.00	-19.57	PK
Vertical	15600.16	49.72	-7.82	41.90	54.00	-12.10	AV
Horizontal	4592.08	73.22	-20.42	52.80	74.00	-21.20	PK
Horizontal	4592.08	59.00	-20.42	38.59	54.00	-15.41	AV
Horizontal	10400.20	63.68	-9.30	54.38	68.20	-13.82	PK
Horizontal	10400.20	49.54	-9.30	40.24	54.00	-13.76	AV
Horizontal	15600.07	61.93	-7.82	54.11	74.00	-19.89	PK
Horizontal	15600.07	49.28	-7.82	41.46	54.00	-12.54	AV
High Channel (5240 MHz)-Above 1G							
Vertical	4739.09	71.71	-20.12	51.59	74.00	-22.41	PK
Vertical	4739.09	59.15	-20.12	39.03	54.00	-14.97	AV
Vertical	10480.12	61.31	-9.18	52.13	68.20	-16.07	PK
Vertical	10480.12	49.99	-9.18	40.81	54.00	-13.19	AV
Vertical	15720.16	61.29	-7.78	53.51	74.00	-20.49	PK
Vertical	15720.16	49.02	-7.78	41.24	54.00	-12.76	AV
Horizontal	4739.20	72.42	-20.12	52.29	74.00	-21.71	PK
Horizontal	4739.20	59.96	-20.12	39.84	54.00	-14.16	AV
Horizontal	10480.08	60.41	-9.18	51.23	68.20	-16.97	PK
Horizontal	10480.08	49.33	-9.18	40.15	54.00	-13.85	AV
Horizontal	15720.01	61.96	-7.78	54.18	74.00	-19.82	PK
Horizontal	15720.01	49.80	-7.78	42.02	54.00	-11.98	AV

Note: PK value is lower than the Average value limit, So average didn't record.
 The 26.5-40G amplitude of spurious emissions that are attenuated by more than 20dB below the permissible value has no need to be reported.
 Emission level (dBuV/m) = 20 log Emission level (uV/m).
 Corrected Reading: Antenna Factor + Cable Loss + Read Level - Preamp Factor = Level.
 The worst case is Antenna A

Test Mode:	TX(5.1G) - 802.11n-HT20
------------	-------------------------

Polar (H/V)	Frequency (MHz)	Reading Level (dBuV/m)	Correct Factor (dB)	Measurement (dBuV/m)	Limits (dBuV/m)	Over (dB)	Detector Type
Low Channel (5180 MHz)-Above 1G							
Vertical	4434.06	73.79	-20.73	53.05	68.20	-15.15	PK
Vertical	4434.06	59.01	-20.73	38.28	54.00	-15.72	AV
Vertical	10360.12	63.42	-9.36	54.06	68.20	-14.14	PK
Vertical	10360.12	49.83	-9.36	40.47	54.00	-13.53	AV
Vertical	15540.00	63.04	-7.84	55.20	74.00	-18.80	PK
Vertical	15540.00	49.63	-7.84	41.79	54.00	-12.21	AV
Horizontal	4434.19	73.74	-20.73	53.01	68.20	-15.19	PK
Horizontal	4434.19	59.59	-20.73	38.86	54.00	-15.14	AV
Horizontal	10360.15	61.94	-9.36	52.58	68.20	-15.62	PK
Horizontal	10360.15	49.65	-9.36	40.29	54.00	-13.71	AV
Horizontal	15540.04	60.09	-7.84	52.25	74.00	-21.75	PK
Horizontal	15540.04	49.28	-7.84	41.44	54.00	-12.56	AV
Middle Channel (5200 MHz)-Above 1G							
Vertical	4592.15	73.35	-20.42	52.93	74.00	-21.07	PK
Vertical	4592.15	59.51	-20.42	39.10	54.00	-14.90	AV
Vertical	10400.12	60.18	-9.30	50.88	68.20	-17.32	PK
Vertical	10400.12	49.40	-9.30	40.10	54.00	-13.90	AV
Vertical	15600.05	60.60	-7.82	52.78	74.00	-21.22	PK
Vertical	15600.05	49.30	-7.82	41.48	54.00	-12.52	AV
Horizontal	4592.13	71.42	-20.42	51.01	74.00	-22.99	PK
Horizontal	4592.13	59.81	-20.42	39.40	54.00	-14.60	AV
Horizontal	10400.19	62.79	-9.30	53.49	68.20	-14.71	PK
Horizontal	10400.19	49.56	-9.30	40.26	54.00	-13.74	AV
Horizontal	15600.00	63.84	-7.82	56.02	74.00	-17.98	PK
Horizontal	15600.00	49.32	-7.82	41.50	54.00	-12.50	AV
High Channel (5240 MHz)-Above 1G							
Vertical	4739.00	71.25	-20.12	51.12	74.00	-22.88	PK
Vertical	4739.00	59.65	-20.12	39.53	54.00	-14.47	AV
Vertical	10480.18	60.08	-9.18	50.90	68.20	-17.30	PK
Vertical	10480.18	49.45	-9.18	40.27	54.00	-13.73	AV
Vertical	15720.02	60.47	-7.78	52.69	74.00	-21.31	PK
Vertical	15720.02	49.52	-7.78	41.74	54.00	-12.26	AV
Horizontal	4739.11	74.37	-20.12	54.25	74.00	-19.75	PK
Horizontal	4739.11	59.53	-20.12	39.41	54.00	-14.59	AV
Horizontal	10480.01	60.61	-9.18	51.43	68.20	-16.77	PK
Horizontal	10480.01	49.55	-9.18	40.37	54.00	-13.63	AV
Horizontal	15720.05	61.77	-7.78	53.99	74.00	-20.01	PK
Horizontal	15720.05	49.81	-7.78	42.03	54.00	-11.97	AV

Note: PK value is lower than the Average value limit, So average didn't record.
 The 26.5-40G amplitude of spurious emissions that are attenuated by more than 20dB below the permissible value has no need to be reported.
 Emission level (dBuV/m) = 20 log Emission level (uV/m).
 Corrected Reading: Antenna Factor + Cable Loss + Read Level - Preamp Factor = Level.
 Test Mode is MIMO Mode.



Test Mode:	TX(5.1G) - 802.11n-HT40
------------	-------------------------

Polar (H/V)	Frequency (MHz)	Reading Level (dBuV/m)	Correct Factor (dB)	Measurement (dBuV/m)	Limits (dBuV/m)	Over (dB)	Detector Type
Low Channel (5190 MHz)-Above 1G							
Vertical	4434.02	74.39	-20.73	53.66	68.20	-14.54	PK
Vertical	4434.02	59.32	-20.73	38.59	54.00	-15.41	AV
Vertical	10380.18	62.80	-9.33	53.47	68.20	-14.73	PK
Vertical	10380.18	49.87	-9.33	40.54	54.00	-13.46	AV
Vertical	15570.19	62.17	-7.83	54.34	74.00	-19.66	PK
Vertical	15570.19	49.42	-7.83	41.59	54.00	-12.41	AV
Horizontal	4434.19	74.38	-20.73	53.65	74.00	-20.35	PK
Horizontal	4434.19	59.11	-20.73	38.38	54.00	-15.62	AV
Horizontal	10380.18	61.88	-9.33	52.55	68.20	-15.65	PK
Horizontal	10380.18	49.13	-9.33	39.80	54.00	-14.20	AV
Horizontal	15570.16	62.13	-7.83	54.30	74.00	-19.70	PK
Horizontal	15570.16	49.18	-7.83	41.35	54.00	-12.65	AV
Middle Channel (5230 MHz)-Above 1G							
Vertical	4739.12	72.45	-20.12	52.32	68.20	-15.88	PK
Vertical	4739.12	59.70	-20.12	39.57	54.00	-14.43	AV
Vertical	10460.06	63.58	-9.21	54.37	68.20	-13.83	PK
Vertical	10460.06	49.34	-9.21	40.13	54.00	-13.87	AV
Vertical	15690.09	63.66	-7.79	55.87	74.00	-18.13	PK
Vertical	15690.09	49.42	-7.79	41.63	54.00	-12.37	AV
Horizontal	4739.06	71.59	-20.12	51.47	68.20	-16.73	PK
Horizontal	4739.06	59.11	-20.12	38.99	54.00	-15.01	AV
Horizontal	10460.17	63.37	-9.21	54.16	68.20	-14.04	PK
Horizontal	10460.17	49.57	-9.21	40.36	54.00	-13.64	AV
Horizontal	15690.13	64.57	-7.79	56.78	74.00	-17.22	PK
Horizontal	15690.13	49.86	-7.79	42.07	54.00	-11.93	AV

Note: PK value is lower than the Average value limit, So average didn't record.

The 26.5-40G amplitude of spurious emissions that are attenuated by more than 20dB below the permissible value has no need to be reported.

Emission level (dBuV/m) = 20 log Emission level (uV/m).

Corrected Reading: Antenna Factor + Cable Loss + Read Level - Preamp Factor = Level.

Test Mode is MIMO Mode.

CO.LTD

Test Mode:	TX(5.1G) - 802.11ac-HT20
------------	--------------------------

Polar (H/V)	Frequency (MHz)	Reading Level (dBuV/m)	Correct Factor (dB)	Measurement (dBuV/m)	Limits (dBuV/m)	Over (dB)	Detector Type
Low Channel (5180 MHz)-Above 1G							
Vertical	4434.16	70.67	-20.73	49.93	68.20	-18.27	PK
Vertical	4434.16	59.51	-20.73	38.78	54.00	-15.22	AV
Vertical	10360.09	64.96	-9.36	55.60	68.20	-12.60	PK
Vertical	10360.09	49.91	-9.36	40.55	54.00	-13.45	AV
Vertical	15540.18	62.31	-7.84	54.47	74.00	-19.53	PK
Vertical	15540.18	49.10	-7.84	41.26	54.00	-12.74	AV
Horizontal	4434.01	71.65	-20.73	50.92	68.20	-17.28	PK
Horizontal	4434.01	59.86	-20.73	39.13	54.00	-14.87	AV
Horizontal	10360.08	61.67	-9.36	52.31	68.20	-15.89	PK
Horizontal	10360.08	49.48	-9.36	40.12	54.00	-13.88	AV
Horizontal	15540.01	62.21	-7.84	54.37	74.00	-19.63	PK
Horizontal	15540.01	49.48	-7.84	41.64	54.00	-12.36	AV
Middle Channel (5200 MHz)-Above 1G							
Vertical	4592.04	73.20	-20.42	52.79	74.00	-21.21	PK
Vertical	4592.04	59.72	-20.42	39.30	54.00	-14.70	AV
Vertical	10400.02	61.57	-9.30	52.27	68.20	-15.93	PK
Vertical	10400.02	49.86	-9.30	40.56	54.00	-13.44	AV
Vertical	15600.10	60.99	-7.82	53.17	74.00	-20.83	PK
Vertical	15600.10	49.51	-7.82	41.69	54.00	-12.31	AV
Horizontal	4592.08	70.53	-20.42	50.11	74.00	-23.89	PK
Horizontal	4592.08	59.05	-20.42	38.64	54.00	-15.36	AV
Horizontal	10400.17	60.05	-9.30	50.75	68.20	-17.45	PK
Horizontal	10400.17	49.39	-9.30	40.09	54.00	-13.91	AV
Horizontal	15600.02	60.88	-7.82	53.06	74.00	-20.94	PK
Horizontal	15600.02	49.55	-7.82	41.73	54.00	-12.27	AV
High Channel (5240 MHz)-Above 1G							
Vertical	4739.03	71.15	-20.12	51.03	74.00	-22.97	PK
Vertical	4739.03	59.30	-20.12	39.18	54.00	-14.82	AV
Vertical	10480.19	64.93	-9.18	55.75	68.20	-12.45	PK
Vertical	10480.19	49.27	-9.18	40.09	54.00	-13.91	AV
Vertical	15720.06	62.74	-7.78	54.96	74.00	-19.04	PK
Vertical	15720.06	49.08	-7.78	41.30	54.00	-12.70	AV
Horizontal	4739.10	71.62	-20.12	51.50	74.00	-22.50	PK
Horizontal	4739.10	59.88	-20.12	39.76	54.00	-14.24	AV
Horizontal	10480.12	63.76	-9.18	54.58	68.20	-13.62	PK
Horizontal	10480.12	49.47	-9.18	40.29	54.00	-13.71	AV
Horizontal	15720.15	61.06	-7.78	53.28	74.00	-20.72	PK
Horizontal	15720.15	49.75	-7.78	41.97	54.00	-12.03	AV

Note: PK value is lower than the Average value limit, So average didn't record.
 The 26.5-40G amplitude of spurious emissions that are attenuated by more than 20dB below the permissible value has no need to be reported.
 Emission level (dBuV/m) = 20 log Emission level (uV/m).
 Corrected Reading: Antenna Factor + Cable Loss + Read Level - Preamp Factor = Level.
 Test Mode is MIMO Mode.

SHENZHEN

Test Mode:	TX(5.1G) - 802.11ac-HT40
------------	--------------------------

Polar (H/V)	Frequency (MHz)	Reading Level (dBuV/m)	Correct Factor (dB)	Measurement (dBuV/m)	Limits (dBuV/m)	Over (dB)	Detector Type
Low Channel (5190 MHz)-Above 1G							
Vertical	4434.12	72.98	-20.73	52.25	68.20	-15.95	PK
Vertical	4434.12	59.06	-20.73	38.33	54.00	-15.67	AV
Vertical	10380.10	60.58	-9.33	51.25	68.20	-16.95	PK
Vertical	10380.10	49.67	-9.33	40.34	54.00	-13.66	AV
Vertical	15570.16	63.90	-7.83	56.07	74.00	-17.93	PK
Vertical	15570.16	49.98	-7.83	42.15	54.00	-11.85	AV
Horizontal	4434.15	72.99	-20.73	52.25	74.00	-21.75	PK
Horizontal	4434.15	59.73	-20.73	39.00	54.00	-15.00	AV
Horizontal	10380.16	60.31	-9.33	50.98	68.20	-17.22	PK
Horizontal	10380.16	49.10	-9.33	39.77	54.00	-14.23	AV
Horizontal	15570.03	64.77	-7.83	56.94	74.00	-17.06	PK
Horizontal	15570.03	49.38	-7.83	41.55	54.00	-12.45	AV
Middle Channel (5230 MHz)-Above 1G							
Vertical	4739.13	70.43	-20.12	50.31	68.20	-17.89	PK
Vertical	4739.13	59.42	-20.12	39.29	54.00	-14.71	AV
Vertical	10460.02	60.79	-9.21	51.58	68.20	-16.62	PK
Vertical	10460.02	49.24	-9.21	40.03	54.00	-13.97	AV
Vertical	15690.10	63.27	-7.79	55.48	74.00	-18.52	PK
Vertical	15690.10	49.33	-7.79	41.54	54.00	-12.46	AV
Horizontal	4739.10	72.10	-20.12	51.98	68.20	-16.22	PK
Horizontal	4739.10	59.35	-20.12	39.23	54.00	-14.77	AV
Horizontal	10460.12	64.13	-9.21	54.92	68.20	-13.28	PK
Horizontal	10460.12	49.63	-9.21	40.42	54.00	-13.58	AV
Horizontal	15690.11	63.85	-7.79	56.06	74.00	-17.94	PK
Horizontal	15690.11	49.17	-7.79	41.38	54.00	-12.62	AV

Note: PK value is lower than the Average value limit, So average didn't record.

The 26.5-40G amplitude of spurious emissions that are attenuated by more than 20dB below the permissible value has no need to be reported.

Emission level (dBuV/m) = 20 log Emission level (uV/m).

Corrected Reading: Antenna Factor + Cable Loss + Read Level - Preamp Factor = Level.

Test Mode is MIMO Mode.

Test Mode:	TX(5.1G) - 802.11ac 80
------------	------------------------

Polar (H/V)	Frequency (MHz)	Reading Level (dBuV/m)	Correct Factor (dB)	Measurement (dBuV/m)	Limits (dBuV/m)	Over (dB)	Detector Type
Low Channel (5210 MHz)-Above 1G							
Vertical	4434.12	70.81	-20.73	50.08	68.20	-18.12	PK
Vertical	4434.12	59.92	-20.73	39.18	54.00	-14.82	AV
Vertical	10420.06	62.72	-9.27	53.45	68.20	-14.75	PK
Vertical	10420.06	49.26	-9.27	39.99	54.00	-14.01	AV
Vertical	15630.17	64.36	-7.81	56.55	74.00	-17.45	PK
Vertical	15630.17	49.30	-7.81	41.49	54.00	-12.51	AV
Horizontal	4434.12	70.52	-20.73	49.79	68.20	-18.41	PK
Horizontal	4434.12	49.58	-20.73	28.84	54.00	-25.16	AV
Horizontal	10420.17	40.14	9.27	49.41	68.20	-18.79	PK
Horizontal	10420.17	29.62	9.27	38.89	54.00	-15.11	AV
Horizontal	15630.09	61.28	-7.81	53.47	74.00	-20.53	PK
Horizontal	15630.09	49.88	-7.81	42.07	54.00	-11.93	AV

Note: PK value is lower than the Average value limit, So average didn't record.
 The 26.5-40G amplitude of spurious emissions that are attenuated by more than 20dB below the permissible value has no need to be reported.
 Emission level (dBuV/m) = 20 log Emission level (uV/m).
 Corrected Reading: Antenna Factor + Cable Loss + Read Level - Preamp Factor = Level.
 Test Mode is MIMO Mode.

BCTC
 BCTC
 PPR
 Report

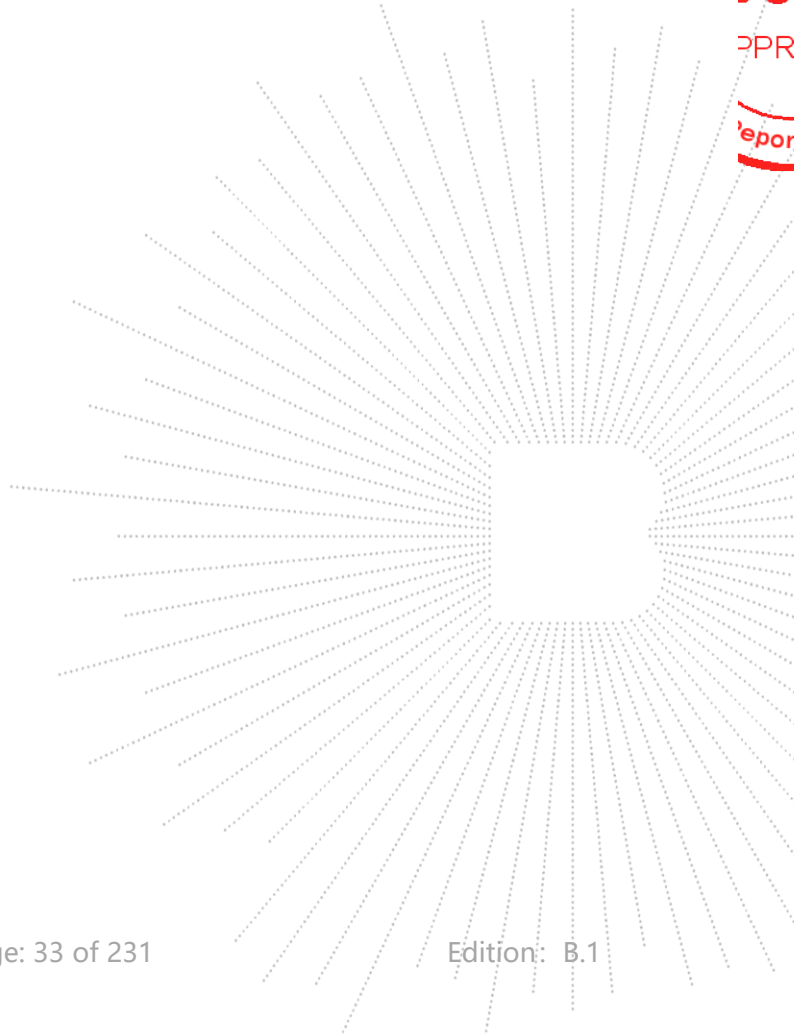

Test Mode:	TX(5.1G) - 802.11ax-HT20
------------	--------------------------

Polar (H/V)	Frequency (MHz)	Reading Level (dBuV/m)	Correct Factor (dB)	Measurement (dBuV/m)	Limits (dBuV/m)	Over (dB)	Detector Type
Low Channel (5180 MHz)-Above 1G							
Vertical	4434.02	71.03	-20.73	50.30	68.20	-17.90	PK
Vertical	4434.02	59.16	-20.73	38.43	54.00	-15.57	AV
Vertical	10360.07	63.45	-9.36	54.09	68.20	-14.11	PK
Vertical	10360.07	49.84	-9.36	40.48	54.00	-13.52	AV
Vertical	15540.11	61.08	-7.84	53.24	74.00	-20.76	PK
Vertical	15540.11	49.01	-7.84	41.17	54.00	-12.83	AV
Horizontal	4434.03	73.06	-20.73	52.32	68.20	-15.88	PK
Horizontal	4434.03	59.33	-20.73	38.60	54.00	-15.40	AV
Horizontal	10360.04	60.48	-9.36	51.12	68.20	-17.08	PK
Horizontal	10360.04	49.15	-9.36	39.79	54.00	-14.21	AV
Horizontal	15540.17	63.58	-7.84	55.74	74.00	-18.26	PK
Horizontal	15540.17	49.55	-7.84	41.71	54.00	-12.29	AV
Middle Channel (5200 MHz)-Above 1G							
Vertical	4592.18	70.87	-20.42	50.45	74.00	-23.55	PK
Vertical	4592.18	59.31	-20.42	38.89	54.00	-15.11	AV
Vertical	10400.11	63.07	-9.30	53.77	68.20	-14.43	PK
Vertical	10400.11	49.10	-9.30	39.80	54.00	-14.20	AV
Vertical	15600.13	62.58	-7.82	54.76	74.00	-19.24	PK
Vertical	15600.13	49.31	-7.82	41.49	54.00	-12.51	AV
Horizontal	4592.15	73.56	-20.42	53.14	74.00	-20.86	PK
Horizontal	4592.15	59.58	-20.42	39.17	54.00	-14.83	AV
Horizontal	10400.10	62.52	-9.30	53.22	68.20	-14.98	PK
Horizontal	10400.10	49.11	-9.30	39.81	54.00	-14.19	AV
Horizontal	15600.16	63.91	-7.82	56.09	74.00	-17.91	PK
Horizontal	15600.16	49.04	-7.82	41.22	54.00	-12.78	AV
High Channel (5240 MHz)-Above 1G							
Vertical	4739.18	73.60	-20.12	53.48	74.00	-20.52	PK
Vertical	4739.18	59.81	-20.12	39.69	54.00	-14.31	AV
Vertical	10480.09	62.34	-9.18	53.16	68.20	-15.04	PK
Vertical	10480.09	49.79	-9.18	40.61	54.00	-13.39	AV
Vertical	15720.07	63.17	-7.78	55.39	74.00	-18.61	PK
Vertical	15720.07	49.50	-7.78	41.72	54.00	-12.28	AV
Horizontal	4739.01	73.54	-20.12	53.42	74.00	-20.58	PK
Horizontal	4739.01	59.54	-20.12	39.41	54.00	-14.59	AV
Horizontal	10480.06	64.68	-9.18	55.50	68.20	-12.70	PK
Horizontal	10480.06	49.17	-9.18	39.99	54.00	-14.01	AV
Horizontal	15720.00	60.70	-7.78	52.92	74.00	-21.08	PK
Horizontal	15720.00	49.47	-7.78	41.69	54.00	-12.31	AV

Note: PK value is lower than the Average value limit, So average didn't record.
 The 26.5-40G amplitude of spurious emissions that are attenuated by more than 20dB below the permissible value has no need to be reported.
 Emission level (dBuV/m) = 20 log Emission level (uV/m).
 Corrected Reading: Antenna Factor + Cable Loss + Read Level - Preamp Factor = Level.
 Test Mode is MIMO Mode.

Test Mode:	TX(5.1G) - 802.11ax-HT40
------------	--------------------------

Polar (H/V)	Frequency (MHz)	Reading Level (dBuV/m)	Correct Factor (dB)	Measurement (dBuV/m)	Limits (dBuV/m)	Over (dB)	Detector Type
Low Channel (5190 MHz)-Above 1G							
Vertical	4434.06	73.52	-20.73	52.79	68.20	-15.41	PK
Vertical	4434.06	59.83	-20.73	39.10	54.00	-14.90	AV
Vertical	10380.12	63.93	-9.33	54.60	68.20	-13.60	PK
Vertical	10380.12	49.07	-9.33	39.74	54.00	-14.26	AV
Vertical	15570.10	62.76	-7.83	54.93	74.00	-19.07	PK
Vertical	15570.10	49.98	-7.83	42.15	54.00	-11.85	AV
Horizontal	4434.13	74.09	-20.73	53.36	74.00	-20.64	PK
Horizontal	4434.13	59.32	-20.73	38.59	54.00	-15.41	AV
Horizontal	10380.10	63.55	-9.33	54.22	68.20	-13.98	PK
Horizontal	10380.10	49.51	-9.33	40.18	54.00	-13.82	AV
Horizontal	15570.16	64.82	-7.83	56.99	74.00	-17.01	PK
Horizontal	15570.16	49.44	-7.83	41.61	54.00	-12.39	AV
Middle Channel (5230 MHz)-Above 1G							
Vertical	4739.08	72.18	-20.12	52.05	68.20	-16.15	PK
Vertical	4739.08	59.13	-20.12	39.01	54.00	-14.99	AV
Vertical	10460.04	60.35	-9.21	51.14	68.20	-17.06	PK
Vertical	10460.04	49.74	-9.21	40.53	54.00	-13.47	AV
Vertical	15690.13	63.66	-7.79	55.87	74.00	-18.13	PK
Vertical	15690.13	49.87	-7.79	42.08	54.00	-11.92	AV
Horizontal	4739.05	71.49	-20.12	51.36	68.20	-16.84	PK
Horizontal	4739.05	59.56	-20.12	39.44	54.00	-14.56	AV
Horizontal	10460.05	63.75	-9.21	54.54	68.20	-13.66	PK
Horizontal	10460.05	49.52	-9.21	40.31	54.00	-13.69	AV
Horizontal	15690.01	62.14	-7.79	54.35	74.00	-19.65	PK
Horizontal	15690.01	49.33	-7.79	41.54	54.00	-12.46	AV

Note: PK value is lower than the Average value limit, So average didn't record.

The 26.5-40G amplitude of spurious emissions that are attenuated by more than 20dB below the permissible value has no need to be reported.

Emission level (dBuV/m) = 20 log Emission level (uV/m).

Corrected Reading: Antenna Factor + Cable Loss + Read Level - Preamp Factor = Level.

Test Mode is MIMO Mode.

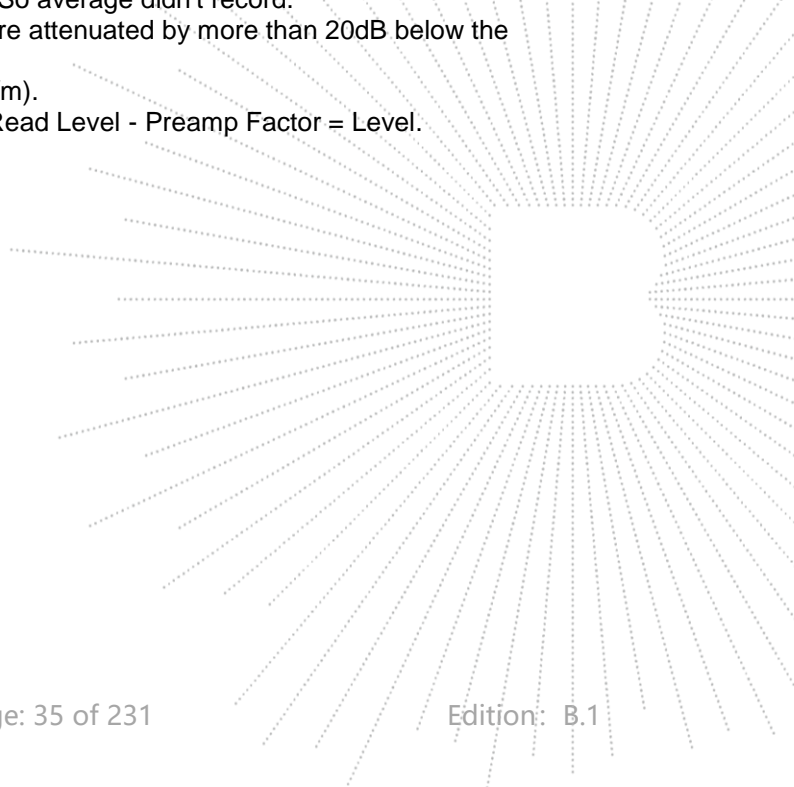

Test Mode:	TX(5.1G) - 802.11ax 80
------------	------------------------

Polar (H/V)	Frequency (MHz)	Reading Level (dBuV/m)	Correct Factor (dB)	Measurement (dBuV/m)	Limits (dBuV/m)	Over (dB)	Detector Type
Low Channel (5210 MHz)-Above 1G							
Vertical	4434.06	72.20	-20.73	51.47	68.20	-16.73	PK
Vertical	4434.06	59.39	-20.73	38.65	54.00	-15.35	AV
Vertical	10420.16	61.67	-9.27	52.40	68.20	-15.80	PK
Vertical	10420.16	49.52	-9.27	40.25	54.00	-13.75	AV
Vertical	15630.04	61.97	-7.81	54.16	74.00	-19.84	PK
Vertical	15630.04	49.30	-7.81	41.49	54.00	-12.51	AV
Horizontal	4434.08	71.61	-20.73	50.88	68.20	-17.32	PK
Horizontal	4434.08	49.60	-20.73	28.87	54.00	-25.13	AV
Horizontal	10420.14	41.09	9.27	50.36	68.20	-17.84	PK
Horizontal	10420.14	29.83	9.27	39.10	54.00	-14.90	AV
Horizontal	15630.03	61.82	-7.81	54.01	74.00	-19.99	PK
Horizontal	15630.03	49.37	-7.81	41.56	54.00	-12.44	AV

Note: PK value is lower than the Average value limit, So average didn't record.
 The 26.5-40G amplitude of spurious emissions that are attenuated by more than 20dB below the permissible value has no need to be reported.
 Emission level (dBuV/m) = 20 log Emission level (uV/m).
 Corrected Reading: Antenna Factor + Cable Loss + Read Level - Preamp Factor = Level.
 Test Mode is MIMO Mode.

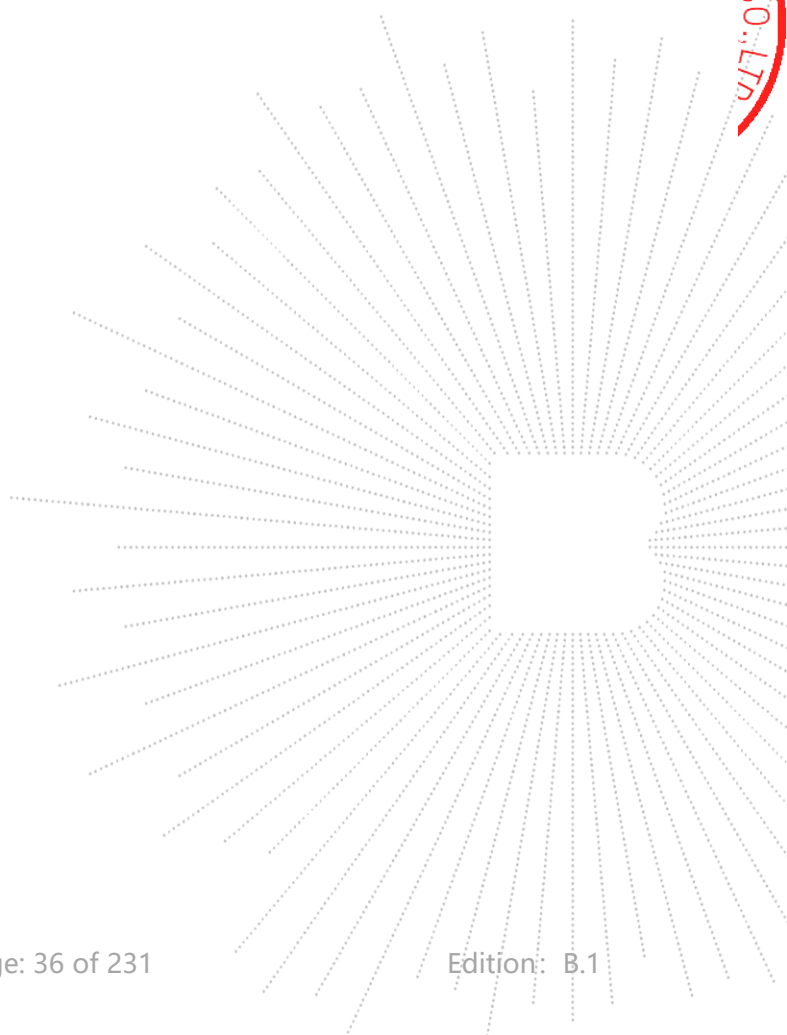
Test Mode:	TX (5.8G) -- 802.11a
------------	----------------------

Polar (H/V)	Frequency (MHz)	Reading Level (dBuV/m)	Correct Factor (dB)	Measurement (dBuV/m)	Limits (dBuV/m)	Over (dB)	Detector Type
Low Channel (5745 MHz)-Above 1G							
Vertical	4679.15	73.11	-20.24	52.87	74.00	-21.13	PK
Vertical	4679.15	59.41	-20.24	39.17	54.00	-14.83	AV
Vertical	11490.10	64.57	-8.79	55.78	68.20	-12.42	PK
Vertical	11490.10	49.06	-8.79	40.27	54.00	-13.73	AV
Vertical	17235.19	59.39	-3.18	56.21	68.20	-11.99	PK
Vertical	17235.19	44.20	-3.18	41.02	54.00	-12.98	AV
Horizontal	4679.19	73.43	-20.73	52.70	74.00	-21.30	PK
Horizontal	4679.19	59.09	-20.73	38.36	54.00	-15.64	AV
Horizontal	11490.11	61.16	-8.79	52.37	68.20	-15.83	PK
Horizontal	11490.11	49.81	-8.79	41.02	54.00	-12.98	AV
Horizontal	17235.13	55.96	-3.18	52.78	68.20	-15.42	PK
Horizontal	17235.13	44.29	-3.18	41.11	54.00	-12.89	AV
Middle Channel (5785 MHz)-Above 1G							
Vertical	4592.17	73.55	-20.42	53.13	74.00	-20.87	PK
Vertical	4592.17	59.01	-20.42	38.60	54.00	-15.40	AV
Vertical	11570.05	61.53	-8.86	52.67	68.20	-15.53	PK
Vertical	11570.05	49.07	-8.86	40.21	54.00	-13.79	AV
Vertical	17355.16	57.51	-2.52	54.99	68.20	-13.21	PK
Vertical	17355.16	44.63	-2.52	42.11	54.00	-11.89	AV
Horizontal	4592.12	70.90	-20.42	50.48	74.00	-23.52	PK
Horizontal	4592.12	59.42	-20.42	39.01	54.00	-14.99	AV
Horizontal	11570.08	64.54	-8.86	55.68	68.20	-12.52	PK
Horizontal	11570.08	49.85	-8.86	40.99	54.00	-13.01	AV
Horizontal	17355.11	57.95	-2.52	55.43	68.20	-12.77	PK
Horizontal	17355.11	44.25	-2.52	41.73	54.00	-12.27	AV
High Channel (5825 MHz)-Above 1G							
Vertical	6039.10	71.81	-18.93	52.88	68.20	-15.32	PK
Vertical	6039.10	59.45	-18.93	40.52	54.00	-13.48	AV
Vertical	11650.01	62.69	-8.92	53.77	74.00	-20.23	PK
Vertical	11650.01	49.85	-8.92	40.93	54.00	-13.07	AV
Vertical	17475.04	59.79	-1.86	57.93	68.20	-10.27	PK
Vertical	17475.04	44.27	-1.86	42.41	54.00	-11.59	AV
Horizontal	6039.18	73.00	-18.93	54.07	68.20	-14.13	PK
Horizontal	6039.18	59.30	-18.93	40.37	54.00	-13.63	AV
Horizontal	11650.10	60.94	-8.92	52.02	74.00	-21.98	PK
Horizontal	11650.10	49.42	-8.92	40.50	54.00	-13.50	AV
Horizontal	17475.04	55.55	-1.86	53.69	68.20	-14.51	PK
Horizontal	17475.04	44.89	-1.86	43.03	54.00	-10.97	AV

Note: PK value is lower than the Average value limit, So average didn't record.
 The 26.5-40G amplitude of spurious emissions that are attenuated by more than 20dB below the permissible value has no need to be reported.
 Emission level (dBuV/m) = 20 log Emission level (uV/m).
 Corrected Reading: Antenna Factor + Cable Loss + Read Level - Preamp Factor = Level.
 The worst case is Antenna A



Test Mode:	TX (5.8G) --802.11n-HT20
------------	--------------------------

Polar (H/V)	Frequency (MHz)	Reading Level (dBuV/m)	Correct Factor (dB)	Measurement (dBuV/m)	Limits (dBuV/m)	Over (dB)	Detector Type
Low Channel (5745 MHz)-Above 1G							
Vertical	4679.05	73.00	-20.24	52.76	74.00	-21.24	PK
Vertical	4679.05	59.50	-20.24	39.26	54.00	-14.74	AV
Vertical	11490.17	63.58	-8.79	54.79	68.20	-13.41	PK
Vertical	11490.17	49.12	-8.79	40.33	54.00	-13.67	AV
Vertical	17235.10	59.45	-3.18	56.27	68.20	-11.93	PK
Vertical	17235.10	44.99	-3.18	41.81	54.00	-12.19	AV
Horizontal	4679.02	70.36	-20.24	50.11	74.00	-23.89	PK
Horizontal	4679.02	59.75	-20.24	39.51	54.00	-14.49	AV
Horizontal	11490.04	64.91	-8.79	56.12	68.20	-12.08	PK
Horizontal	11490.04	49.93	-8.79	41.14	54.00	-12.86	AV
Horizontal	17235.16	55.55	-3.18	52.37	68.20	-15.83	PK
Horizontal	17235.16	44.89	-3.18	41.71	54.00	-12.29	AV
Middle Channel (5785 MHz)-Above 1G							
Vertical	4592.14	70.59	-20.42	50.17	74.00	-23.83	PK
Vertical	4592.14	59.30	-20.42	38.88	54.00	-15.12	AV
Vertical	11570.14	61.29	-8.86	52.43	68.20	-15.77	PK
Vertical	11570.14	49.62	-8.86	40.76	54.00	-13.24	AV
Vertical	17355.02	59.12	-2.52	56.60	68.20	-11.60	PK
Vertical	17355.02	44.82	-2.52	42.30	54.00	-11.70	AV
Horizontal	4592.01	73.83	-20.42	53.41	74.00	-20.59	PK
Horizontal	4592.01	59.87	-20.42	39.46	54.00	-14.54	AV
Horizontal	11570.08	62.80	-8.86	53.94	68.20	-14.26	PK
Horizontal	11570.08	49.26	-8.86	40.40	54.00	-13.60	AV
Horizontal	17355.20	55.40	-2.52	52.88	68.20	-15.32	PK
Horizontal	17355.20	44.05	-2.52	41.53	54.00	-12.47	AV
High Channel (5825 MHz)-Above 1G							
Vertical	6039.08	72.38	-18.93	53.45	68.20	-14.75	PK
Vertical	6039.08	59.75	-18.93	40.82	54.00	-13.18	AV
Vertical	11650.18	63.88	-8.92	54.96	74.00	-19.04	PK
Vertical	11650.18	49.09	-8.92	40.17	54.00	-13.83	AV
Vertical	17475.06	57.72	-1.86	55.86	68.20	-12.34	PK
Vertical	17475.06	44.96	-1.86	43.10	54.00	-10.90	AV
Horizontal	6039.14	71.63	-18.93	52.70	68.20	-15.50	PK
Horizontal	6039.14	59.36	-18.93	40.43	54.00	-13.57	AV
Horizontal	11650.04	64.82	-8.92	55.90	74.00	-18.10	PK
Horizontal	11650.04	49.80	-8.92	40.88	54.00	-13.12	AV
Horizontal	17475.04	57.64	-1.86	55.78	68.20	-12.42	PK
Horizontal	17475.04	44.13	-1.86	42.27	54.00	-11.73	AV

Note: PK value is lower than the Average value limit, So average didn't record.
 The 26.5-40G amplitude of spurious emissions that are attenuated by more than 20dB below the permissible value has no need to be reported.
 Emission level (dBuV/m) = 20 log Emission level (uV/m).
 Corrected Reading: Antenna Factor + Cable Loss + Read Level - Preamp Factor = Level.
 Test Mode is MIMO Mode.



Test Mode:	TX (5.8G) -- 802.11n-HT40
------------	---------------------------

Polar (H/V)	Frequency (MHz)	Reading Level (dBuV/m)	Correct Factor (dB)	Measurement (dBuV/m)	Limits (dBuV/m)	Over (dB)	Detector Type
Low Channel (5755 MHz)-Above 1G							
Vertical	4679.00	71.02	-20.24	50.78	74.00	-23.22	PK
Vertical	4679.00	59.80	-20.24	39.56	54.00	-14.44	AV
Vertical	11510.14	60.81	-8.81	52.00	74.00	-22.00	PK
Vertical	11510.14	49.42	-8.81	40.61	54.00	-13.39	AV
Vertical	17265.09	56.09	-3.01	53.08	68.20	-15.12	PK
Vertical	17265.09	44.23	-3.01	41.22	54.00	-12.78	AV
Horizontal	4679.10	72.17	-20.24	51.93	74.00	-22.07	PK
Horizontal	4679.10	59.55	-20.24	39.31	54.00	-14.69	AV
Horizontal	11510.16	60.35	-8.81	51.54	74.00	-22.46	PK
Horizontal	11510.16	49.83	-8.81	41.02	54.00	-12.98	AV
Horizontal	17265.05	58.45	-3.01	55.44	68.20	-12.76	PK
Horizontal	17265.05	44.09	-3.01	41.08	54.00	-12.92	AV
Middle Channel (5795 MHz)-Above 1G							
Vertical	6039.13	74.13	-18.93	55.20	68.20	-13.00	PK
Vertical	6039.13	59.78	-18.93	40.85	54.00	-13.15	AV
Vertical	11590.01	62.12	-8.87	53.25	74.00	-20.75	PK
Vertical	11590.01	49.81	-8.87	40.94	54.00	-13.06	AV
Vertical	17385.10	56.78	-2.35	54.43	68.20	-13.77	PK
Vertical	17385.10	44.28	-2.35	41.93	54.00	-12.07	AV
Horizontal	6039.10	71.14	-18.93	52.20	68.20	-16.00	PK
Horizontal	6039.10	59.02	-18.93	40.09	54.00	-13.91	AV
Horizontal	11590.05	63.73	-8.87	54.86	74.00	-19.14	PK
Horizontal	11590.05	49.36	-8.87	40.49	54.00	-13.51	AV
Horizontal	17385.10	57.74	-2.35	55.39	68.20	-12.81	PK
Horizontal	17385.10	44.26	-2.35	41.91	54.00	-12.09	AV

Note: PK value is lower than the Average value limit, So average didn't record.

The 26.5-40G amplitude of spurious emissions that are attenuated by more than 20dB below the permissible value has no need to be reported.

Emission level (dBuV/m) = 20 log Emission level (uV/m).

Corrected Reading: Antenna Factor + Cable Loss + Read Level - Preamp Factor = Level.

Test Mode is MIMO Mode.



Test Mode:	TX (5.8G) --802.11ac-HT20
------------	---------------------------

Polar (H/V)	Frequency (MHz)	Reading Level (dBuV/m)	Correct Factor (dB)	Measurement (dBuV/m)	Limits (dBuV/m)	Over (dB)	Detector Type
Low Channel (5745 MHz)-Above 1G							
Vertical	4679.08	73.94	-20.24	53.70	74.00	-20.30	PK
Vertical	4679.08	59.43	-20.24	39.19	54.00	-14.81	AV
Vertical	11490.20	61.34	-8.79	52.55	68.20	-15.65	PK
Vertical	11490.20	49.88	-8.79	41.09	54.00	-12.91	AV
Vertical	17235.08	59.60	-3.18	56.42	68.20	-11.78	PK
Vertical	17235.08	44.45	-3.18	41.27	54.00	-12.73	AV
Horizontal	4679.05	74.64	-20.24	54.40	74.00	-19.60	PK
Horizontal	4679.05	59.47	-20.24	39.22	54.00	-14.78	AV
Horizontal	11490.19	64.94	-8.79	56.15	68.20	-12.05	PK
Horizontal	11490.19	49.59	-8.79	40.80	54.00	-13.20	AV
Horizontal	17235.18	56.47	-3.18	53.29	68.20	-14.91	PK
Horizontal	17235.18	44.22	-3.18	41.04	54.00	-12.96	AV
Middle Channel (5785 MHz)-Above 1G							
Vertical	4592.10	73.43	-20.42	53.02	74.00	-20.98	PK
Vertical	4592.10	59.20	-20.42	38.79	54.00	-15.21	AV
Vertical	11570.16	60.65	-8.86	51.79	68.20	-16.41	PK
Vertical	11570.16	49.44	-8.86	40.58	54.00	-13.42	AV
Vertical	17355.10	56.28	-2.52	53.76	68.20	-14.44	PK
Vertical	17355.10	44.27	-2.52	41.75	54.00	-12.25	AV
Horizontal	4592.15	73.90	-20.42	53.48	74.00	-20.52	PK
Horizontal	4592.15	59.15	-20.42	38.74	54.00	-15.26	AV
Horizontal	11570.06	62.90	-8.86	54.04	68.20	-14.16	PK
Horizontal	11570.06	49.72	-8.86	40.86	54.00	-13.14	AV
Horizontal	17355.09	58.61	-2.52	56.09	68.20	-12.11	PK
Horizontal	17355.09	44.47	-2.52	41.95	54.00	-12.05	AV
High Channel (5825 MHz)-Above 1G							
Vertical	6039.14	72.04	-18.93	53.11	68.20	-15.09	PK
Vertical	6039.14	59.16	-18.93	40.23	54.00	-13.77	AV
Vertical	11650.13	63.30	-8.92	54.38	74.00	-19.62	PK
Vertical	11650.13	49.41	-8.92	40.49	54.00	-13.51	AV
Vertical	17475.17	57.01	-1.86	55.15	68.20	-13.05	PK
Vertical	17475.17	44.31	-1.86	42.45	54.00	-11.55	AV
Horizontal	6039.14	70.13	-18.93	51.19	68.20	-17.01	PK
Horizontal	6039.14	59.29	-18.93	40.36	54.00	-13.64	AV
Horizontal	11650.09	60.03	-8.92	51.11	74.00	-22.89	PK
Horizontal	11650.09	49.98	-8.92	41.06	54.00	-12.94	AV
Horizontal	17475.02	58.91	-1.86	57.05	68.20	-11.15	PK
Horizontal	17475.02	44.20	-1.86	42.34	54.00	-11.66	AV

Note: PK value is lower than the Average value limit, So average didn't record.
 The 26.5-40G amplitude of spurious emissions that are attenuated by more than 20dB below the permissible value has no need to be reported.
 Emission level (dBuV/m) = 20 log Emission level (uV/m).
 Corrected Reading: Antenna Factor + Cable Loss + Read Level - Preamp Factor = Level.
 Test Mode is MIMO Mode.

