

FCC/IC - TEST REPORT

Report Number : **68.950.22.0953.01** Date of Issue: **October 25, 2022**

Model / HVIN : **MBMMSC**

Product Type : **MOTHER Bracelet**

Applicant : **MEDIROM Healthcare Technologies Inc,**

Address : **Daiba 2-3-1, Minato-ku , Tokyo , Japan**

Manufacturer : **MEDIROM Healthcare Technologies Inc,**

Address : **Daiba 2-3-1, Minato-ku , Tokyo , Japan**

Test Result : **Positive** **Negative**

Total pages including Appendices : **37**

Any use for advertising purposes must be granted in writing. This technical report may only be quoted in full. This report is the result of a single examination of the object in question and is not generally applicable evaluation of the quality of other products in regular production. For further details, please see testing and certification regulation, chapter A-3.4.



1 Table of Contents

1	Table of Contents	2
2	Details about the Test Laboratory	3
3	Description of the Equipment Under Test	4
4	Summary of Test Standards	5
5	Summary of Test Results	6
6	General Remarks	7
7	Test Setups	8
8	Systems Test Configuration	9
9	Technical Requirement	10
9.1	Conducted Emission	10
9.2	Conducted Peak Output Power & EIRP	13
9.3	Power Spectral Density	15
9.4	6 dB Bandwidth and 99% Occupied Bandwidth.....	18
9.5	Spurious RF Conducted Emissions	23
9.6	Band Edge.....	29
9.7	Spurious Radiated Emissions for Transmitter.....	32
10	Test Equipment List.....	36
11	System Measurement Uncertainty	38

2 Details about the Test Laboratory

Details about the Test Laboratory

Test Site 1

Company name: TÜV SÜD Certification and Testing (China) Co., Ltd. Shenzhen Branch
Building 12 & 13, Zhiheng Wisdomland Business Park, Nantou Checkpoint
Road 2, Nanshan District
Shenzhen 518052
P.R. China

Telephone: 86 755 8828 6998

Fax: 86 755 8828 5299

FCC Registration No.: 514049

FCC Designation Number: CA5009

IC Registration No.: 10320A

3 Description of the Equipment Under Test

Product:	MOTHER Bracelet
Model no.:	MBMMSC
Brand name:	MOTHER Bracelet
Hardware Version Identification No. (HVIN)	MBMMSC
FCC ID:	2A8ZF-MBMMSC
IC:	29535-MBMMSC
Options and accessories:	Charger
Rating:	Supplied by 3.85VDC 82mAh Li-ion Rechargeable Battery
RF Transmission Frequency:	2402MHz-2480MHz
No. of Operated Channel:	40
Modulation:	GFSK
Antenna Type:	Ceramic chip antenna
Antenna	Gain: -2.0dBi
Description of the EUT:	The Equipment Under Test (EUT) is a health monitoring bracelet which support Bluetooth function.

NOTE: The above EUT's information is declared by manufacturer. Please refer to the specifications or user's manual for more detailed description.

4 Summary of Test Standards

Test Standards	
FCC Part 15 Subpart C 10-1-2021 Edition	PART 15 - RADIO FREQUENCY DEVICES Subpart C - Intentional Radiators
RSS-Gen Issue 5 April 2018 + A1 + A2	General Requirements for Compliance of Radio Apparatus
RSS-247 Issue 2 February 2017	Digital Transmission Systems (DTSS), Frequency Hopping Systems (FHSS) and License-Exempt Local Area Network (LE-LAN) Devices

All the test methods were according to KDB 558074 D01 15.247 Meas Guidance v05r02 Measurement Guidance and ANSI C63.10 (2013).

5 Summary of Test Results

Technical Requirements			
FCC Part 15 Subpart C/ RSS-247 Issue 2/RSS-Gen Issue 5			
Test Condition		Pages	Test Result
§15.207& RSS-Gen 8.8	Conducted emission AC power port	10	Pass
§15.247(b)(1)	Conducted peak output power	13	Pass
RSS-247 5.4(b)	Equivalent Isotropic Radiated Power	13	Pass
§15.247(e) & RSS-247 5.2(b)	Power spectral density	15	Pass
§15.247(a)(2) & RSS-247 5.2(a) & RSS-Gen 6.7	6dB bandwidth and 99% Occupied Bandwidth	18	Pass
§15.247(a)(1) & RSS-247 5.1(a) & RSS-Gen 6.7	20dB bandwidth and 99% Occupied Bandwidth	--	N/A
§15.247(a)(1) & RSS-247 5.1(b)	Min. of Hopping Channel Carrier Frequency Separation	--	N/A
§15.247(a)(1)(iii) & RSS-247 5.1(d)	Min number of hopping frequencies	--	N/A
§15.247(a)(1)(iii) & RSS-247 5.1(d)	Dwell Time - Average Time of Occupancy	--	N/A
§15.247(d) & RSS-247 5.5	Spurious RF conducted emissions	24	Pass
§15.247(d) & RSS-247 5.5	Band edge	32	Pass
§15.247(d) & §15.209 & RSS-247 5.5 & RSS-Gen 6.13	Spurious radiated emissions for transmitter	35	Pass
§15.203 & RSS-Gen 6.8	Antenna requirement	See note 2	Pass

Note 1: N/A=Not Applicable.

Note 2: The EUT uses integral antenna which gain is -2.0dBi. In accordance to §15.203 & RSS-Gen 6.8, it is considered sufficiently to comply with the provisions of this section.

6 General Remarks

Remarks

This submittal(s) (test report) is intended for FCC ID: 2A8ZF-MBMMSC, IC: 29535-MBMMSC, complies with Section 15.207, 15.209, 15.247 of the FCC Part 15, Subpart C rules and RSS-247, RSS-GEN.

SUMMARY:

All tests according to the regulations cited on page 5 were

■ - Performed

□ - **Not** Performed

The Equipment under Test

■ - **Fulfills** the general approval requirements.

□ - **Does not** fulfill the general approval requirements.

Sample Received Date: October 10, 2022

Testing Start Date: October 11, 2022

Testing End Date: October 22, 2022

- TÜV SÜD Certification and Testing (China) Co., Ltd. Shenzhen Branch -

Reviewed by:

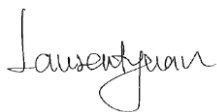

Laurent Yuan
Section Manager

Prepared by:

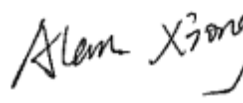

Alan Xiong
Project Engineer

Tested by:



Carry Cai
Test Engineer



7 Test Setups

7.1 Radiated test setups

Below 1GHz

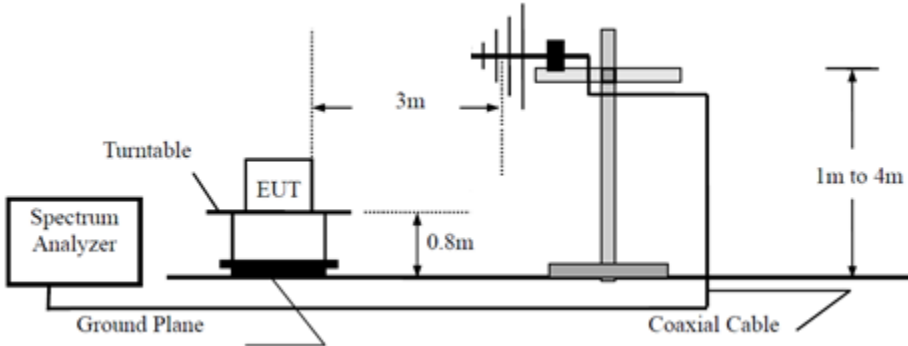

Above 1GHz

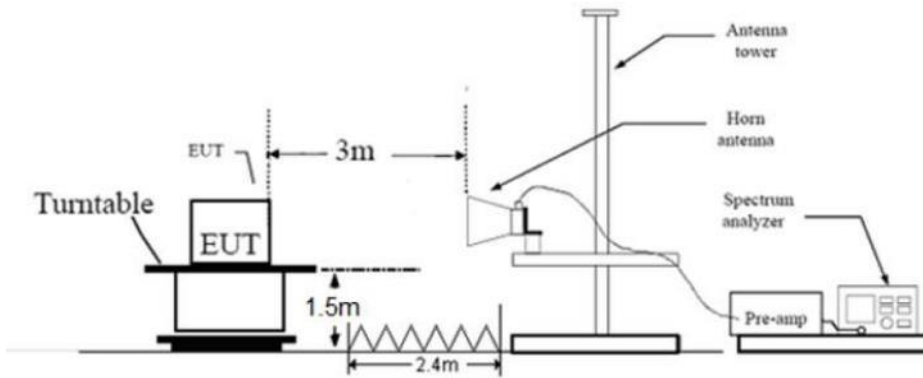

7.2 Conducted RF test setups

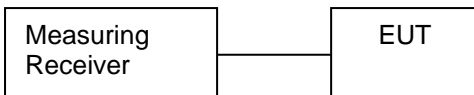

8 Systems Test Configuration

Auxiliary Equipment Used during Test:

Description	Manufacturer	Model NO.	S/N
Laptop	Thinkpad	X230	0A72162
Adapter	APPLE	A1357	Output 5.1V2.1A

9 Technical Requirement

9.1 Conducted Emission

Test Method

1. The EUT was placed 0.4 meter from the conducting wall of the shielding room was kept at least 80 centimeters from any other grounded conducting surface.
2. Connect EUT to the power mains through a line impedance stabilization network (LISN).
3. All the support units are connecting to the other LISN.
4. The LISN provides 50 ohm coupling impedance for the measuring instrument.
5. Both sides of AC line were checked for maximum conducted interference.
6. The frequency range from 150 kHz to 30 MHz was searched.
7. Set the test-receiver system to Peak Detect Function and specified bandwidth (IF Bandwidth = 9kHz) with Maximum Hold Mode. Then measurement is also conducted by Average Detector and Quasi-Peak Detector Function respectively.

Limit

Frequency MHz	QP Limit dB μ V	AV Limit dB μ V
0.150-0.500	66-56*	56-46*
0.500-5	56	46
5-30	60	50

*Decreases with the logarithm of the frequency.

Conducted Emission

Product Type : MOTHER Bracelet
 M/N : MBMMSC
 Operating Condition : Charging Mode
 Test Specification : Line
 Comment : AC 120V/60Hz

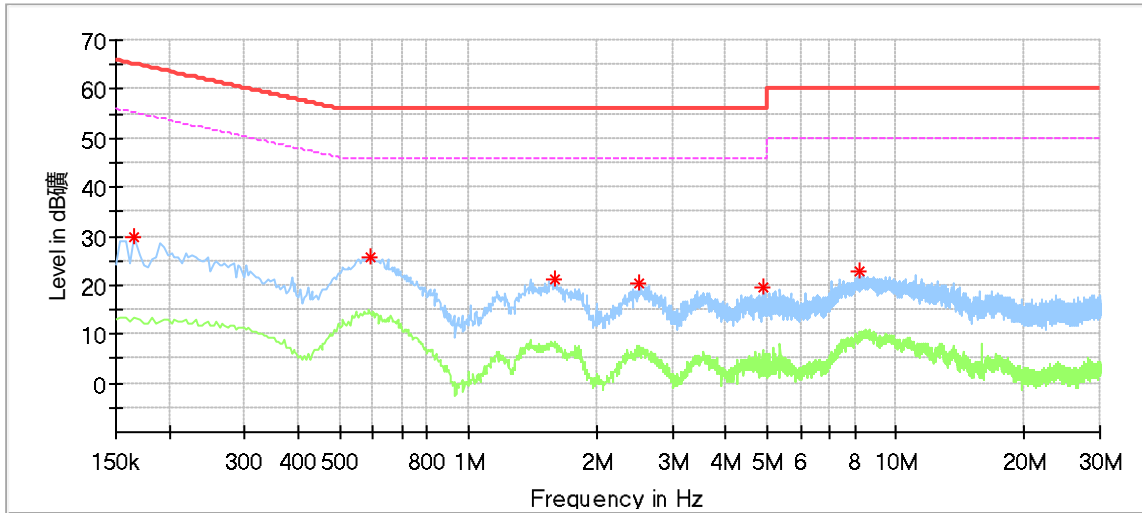

Frequency (MHz)	Max Peak (dBµV)	Average (dBµV)	Limit (dBµV)	Margin (dB)	Line	Corr. (dB)
0.166000	29.71	---	65.16	35.45	L1	9.58
0.590000	25.69	---	56.00	30.31	L1	9.63
1.590000	21.33	---	56.00	34.67	L1	9.65
2.514000	20.19	---	56.00	35.81	L1	9.68
4.870000	19.67	---	56.00	36.33	L1	9.77
8.214000	22.94	---	60.00	37.06	L1	9.89
0.166000	29.71	---	65.16	35.45	L1	9.58

Remark:

Max Peak= Read level + Corrector factor

Correct factor=cable loss + LISN factor

Conducted Emission

Product Type : MOTHER Bracelet
 M/N : MBMMSC
 Operating Condition : Charging Mode
 Test Specification : Neutral
 Comment : AC 120V/60Hz

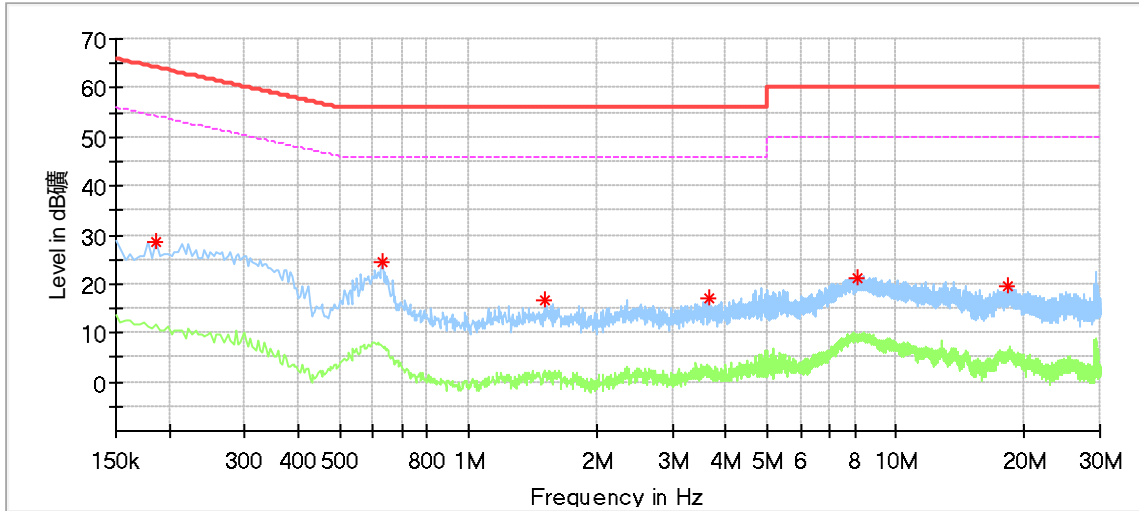

Frequency (MHz)	Max Peak (dBµV)	Average (dBµV)	Limit (dBµV)	Margin (dB)	Line	Corr. (dB)
0.186000	28.43	---	64.21	35.79	N	9.58
0.630000	24.42	---	56.00	31.58	N	9.64
1.506000	16.51	---	56.00	39.49	N	9.65
3.642000	17.10	---	56.00	38.90	N	9.72
8.126000	21.20	---	60.00	38.80	N	9.88
18.274000	19.73	---	60.00	40.27	N	10.04

Remark:
 Max Peak= Read level + Corrector factor
 Correct factor=cable loss + LISN factor

9.2 Conducted Peak Output Power & EIRP

Test Method

1. The RF output of EUT was connected to the power meter by RF cable. The path loss was compensated to the results for each measurement.
2. Set to the maximum power setting and enable the EUT transmit continuously
3. Use the following test receiver settings:
Span = approximately 5 times the 6dB bandwidth, centered on a hopping channel
RBW > the 6dB bandwidth of the emission being measured, VBW \geq 3RBW,
Sweep = auto, Detector function = peak, Trace = max hold
4. Allow the trace to stabilize. Use the marker-to-peak function to set the marker to the peak of the emission. The indicated level is the peak output power and record the results in the test report.
5. Repeat above procedures until all frequencies measured were complete.

Limits

According to §15.247 (b) (1) & RSS-247 5.4(b), conducted peak output power limit as below:

Frequency Range MHz	Limit W	Limit dBm
2400-2483.5	≤ 1	≤ 30

According to & RSS-247 5.4(b), EIRP limit as below:

Frequency Range MHz	Limit W	Limit dBm
2400-2483.5	≤ 4	≤ 36



Conducted Peak Output Power & EIRP

Frequency MHz	Mode	Conducted Peak Output Power dBm	Antenna Gain dBi	EIRP dBm	Result
Bottom channel 2402MHz	LE 1M	-0.64	-2.0	-2.64	Pass
Middle channel 2440MHz	LE 1M	-0.92	-2.0	-2.92	Pass
Top channel 2480MHz	LE 1M	-1.51	-2.0	-3.51	Pass

9.3 Power Spectral Density

Test Method

1. The RF output of EUT was connected to the test receiver by RF cable. The path loss was compensated to the results for each measurement.
2. Set to the maximum power setting and enable the EUT transmit continuously
3. Set analyzer center frequency to DTS channel center frequency. RBW=3kHz, VBW≥3RBW, Span=1.5 times DTS bandwidth, Detector=Peak, Sweep=auto, Trace= max hold.
4. Allow the trace to stabilize. Use the marker-to-peak function to set the marker to the peak of the emission. The indicated level is the peak output power and record the results in the test report.
5. Repeat above procedures until other frequencies measured were completed.

Limit

Limit [dBm]

≤8

Test result

Frequency MHz	Mode	Power spectral density dBm/3KHz	Result
Bottom channel 2402MHz	LE 1M	-16.01	Pass
Middle channel 2440MHz	LE 1M	-16.64	Pass
Top channel 2480MHz	LE 1M	-17.59	Pass

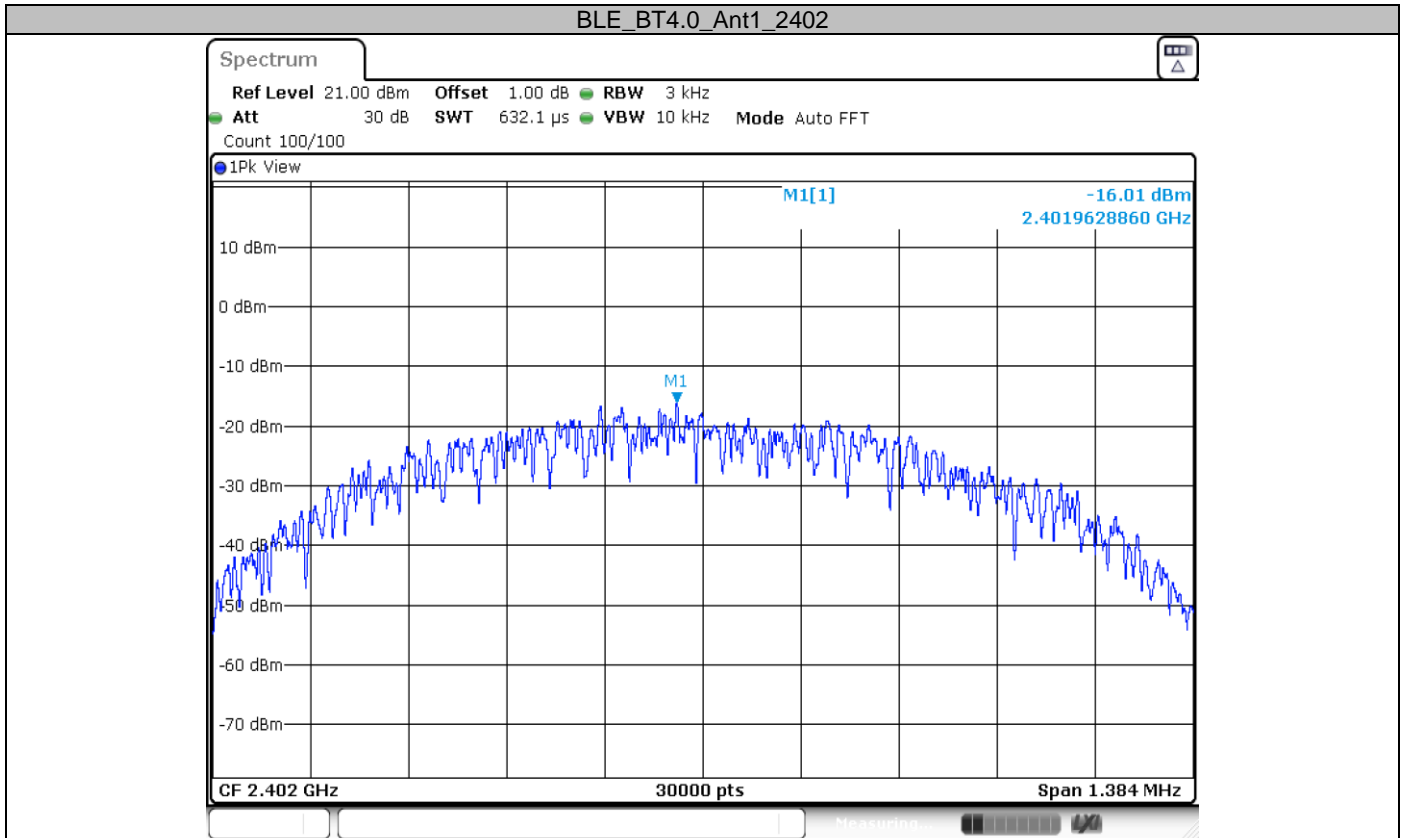

Date: 12.OCT.2022 15:39:37

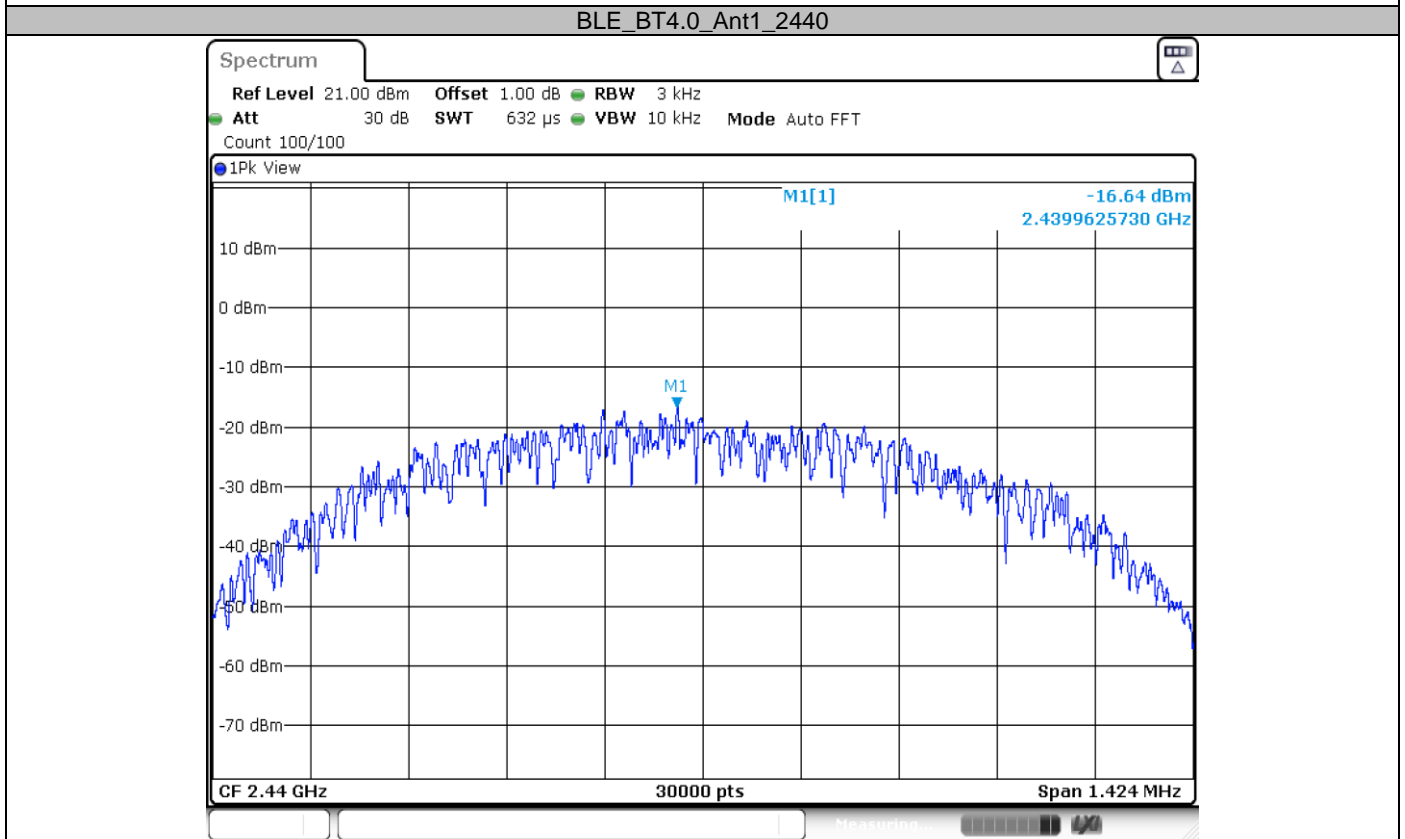

Date: 12.OCT.2022 15:44:03

BLE_BT4.0_Ant1_2480

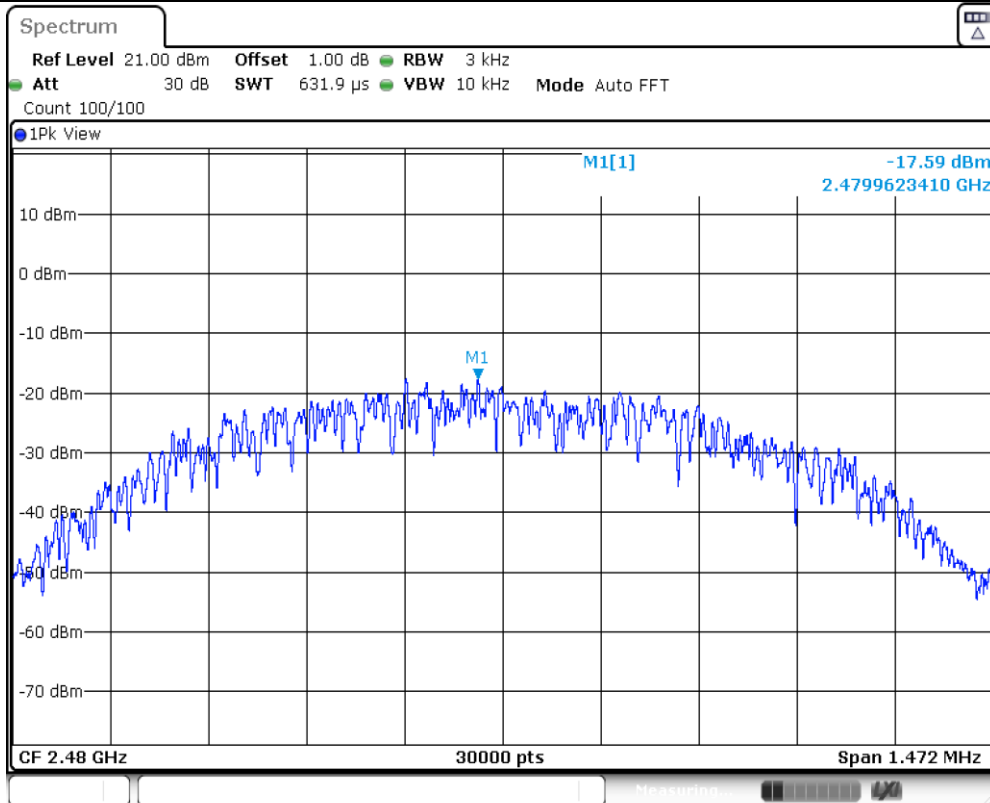

Date: 12.OCT.2022 15:46:03

9.4 6 dB Bandwidth and 99% Occupied Bandwidth

Test Method

1. The RF output of EUT was connected to the test receiver by RF cable. The path loss was compensated to the results for each measurement.
2. Set to the maximum power setting and enable the EUT transmit continuously.
3. Use the following test receiver settings:
 Span = approximately 5 times the 6dB bandwidth, centered on a hopping channel
 RBW =100KHz, VBW≥3RBW,
 Sweep = auto, Detector function = peak, Trace = max hold
4. Allow the trace to stabilize. Use the marker-to-peak function to set the marker to the peak of the emission. Measure the frequency difference of two frequencies that were attenuated 6 dB from the reference level. Record the frequency difference as the emission bandwidth. Record the results.
5. Repeat above procedures until all frequencies measured were complete.

Limit

Limit [kHz]

≥500

Test result

Frequency MHz	Mode	6dB bandwidth MHz	99% bandwidth MHz	Result
Bottom channel 2402MHz	LE 1M	0.692	1.039	Pass
Middle channel 2440MHz	LE 1M	0.712	1.055	Pass
Top channel 2480MHz	LE 1M	0.736	1.079	Pass

6 dB Bandwidth

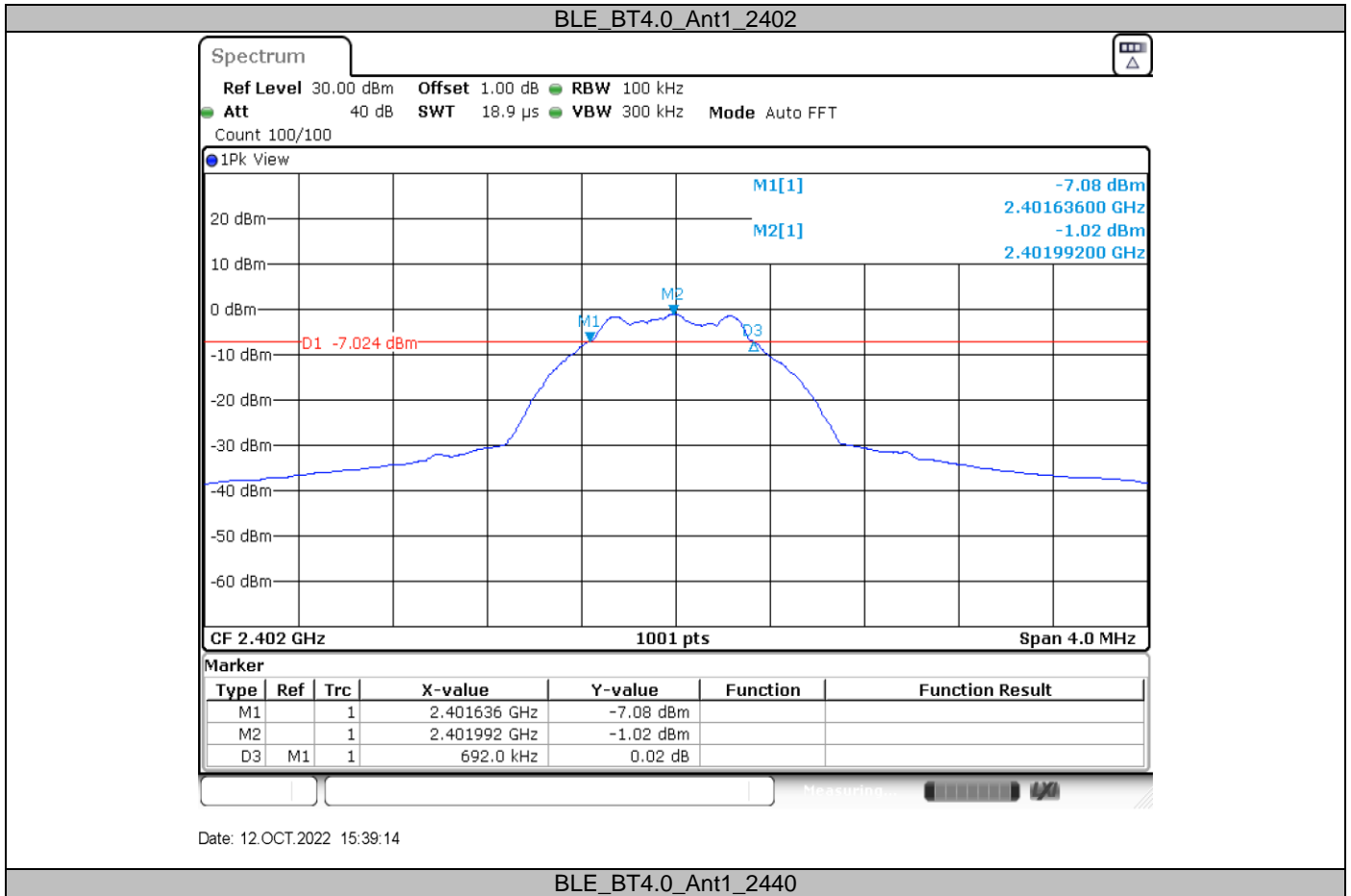

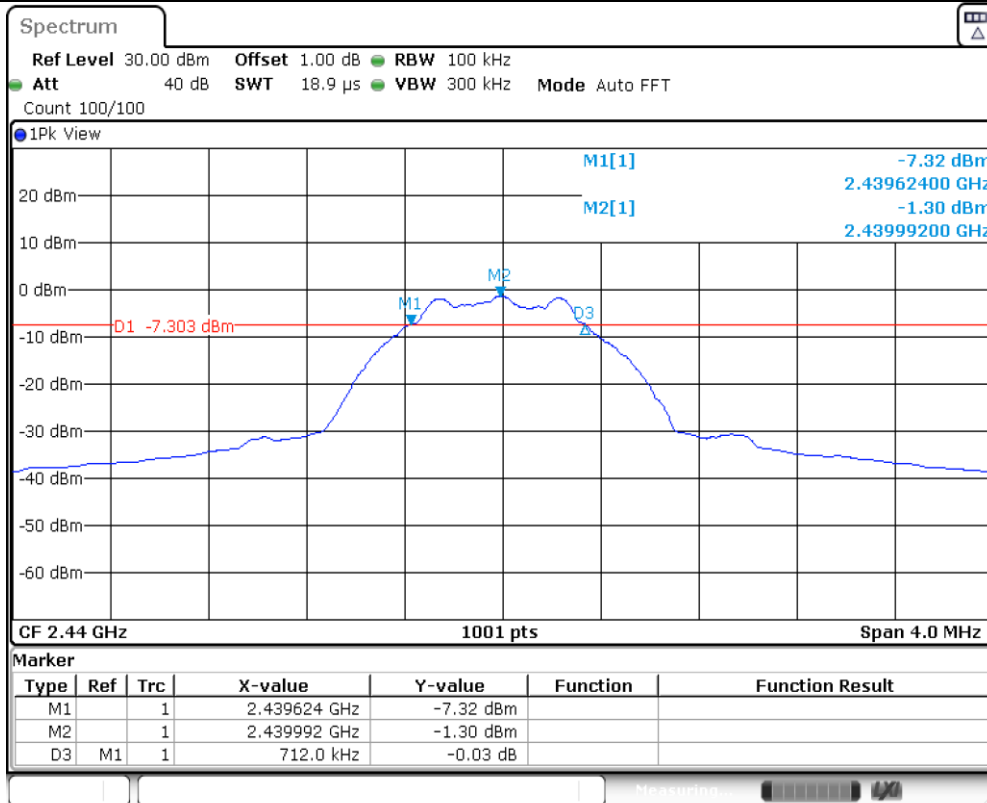

Date: 12.OCT.2022 15:43:40

BLE BT4.0 Ant1_2480

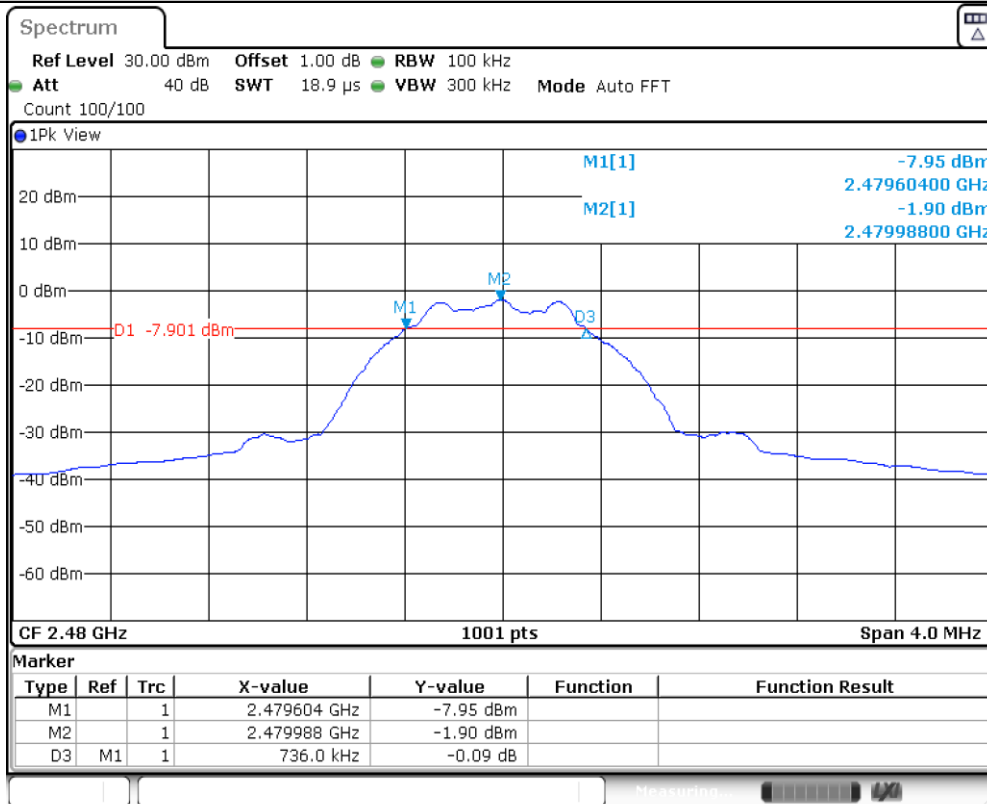

Date: 12.OCT.2022 15:45:40

99% Bandwidth

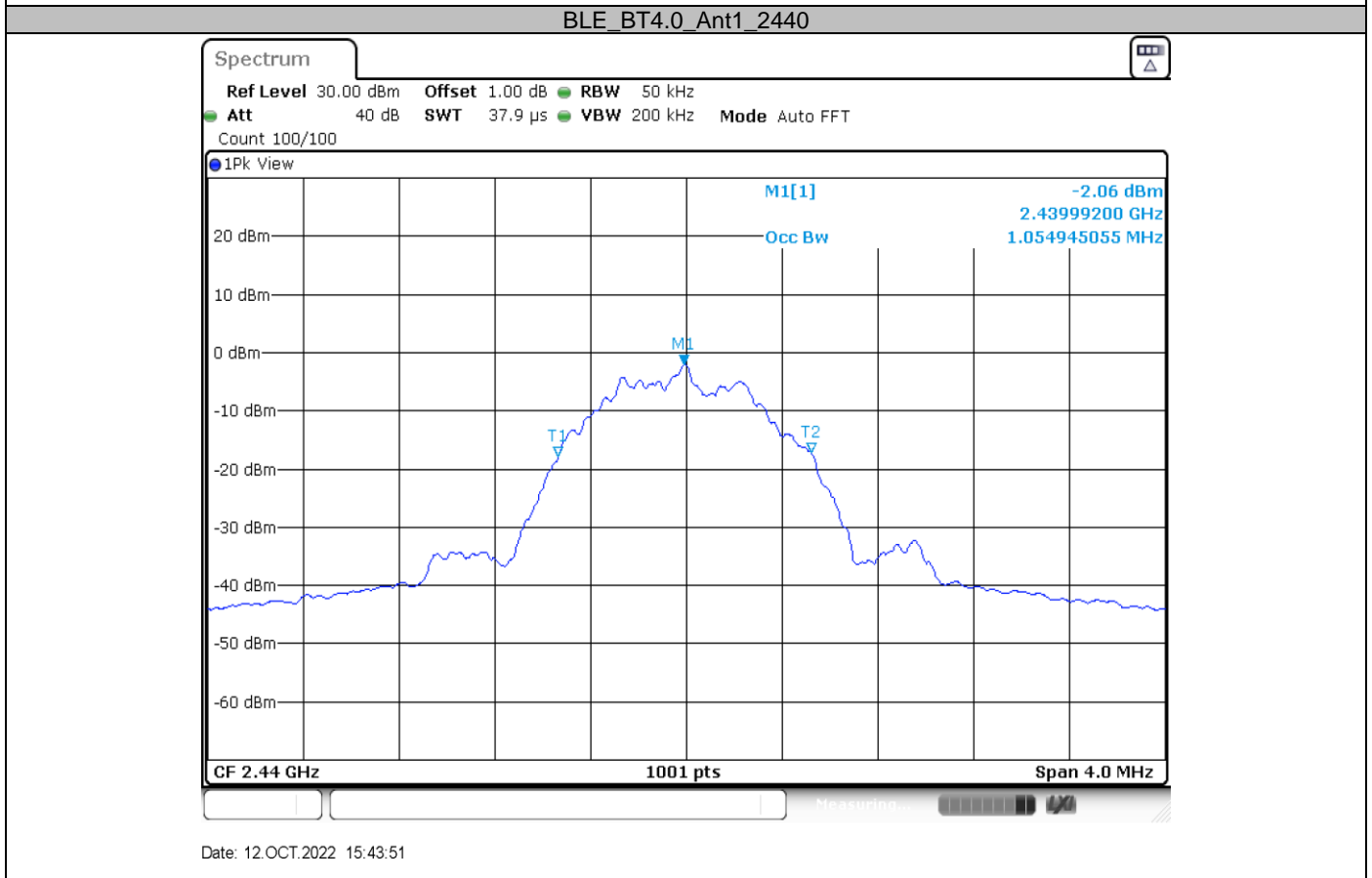
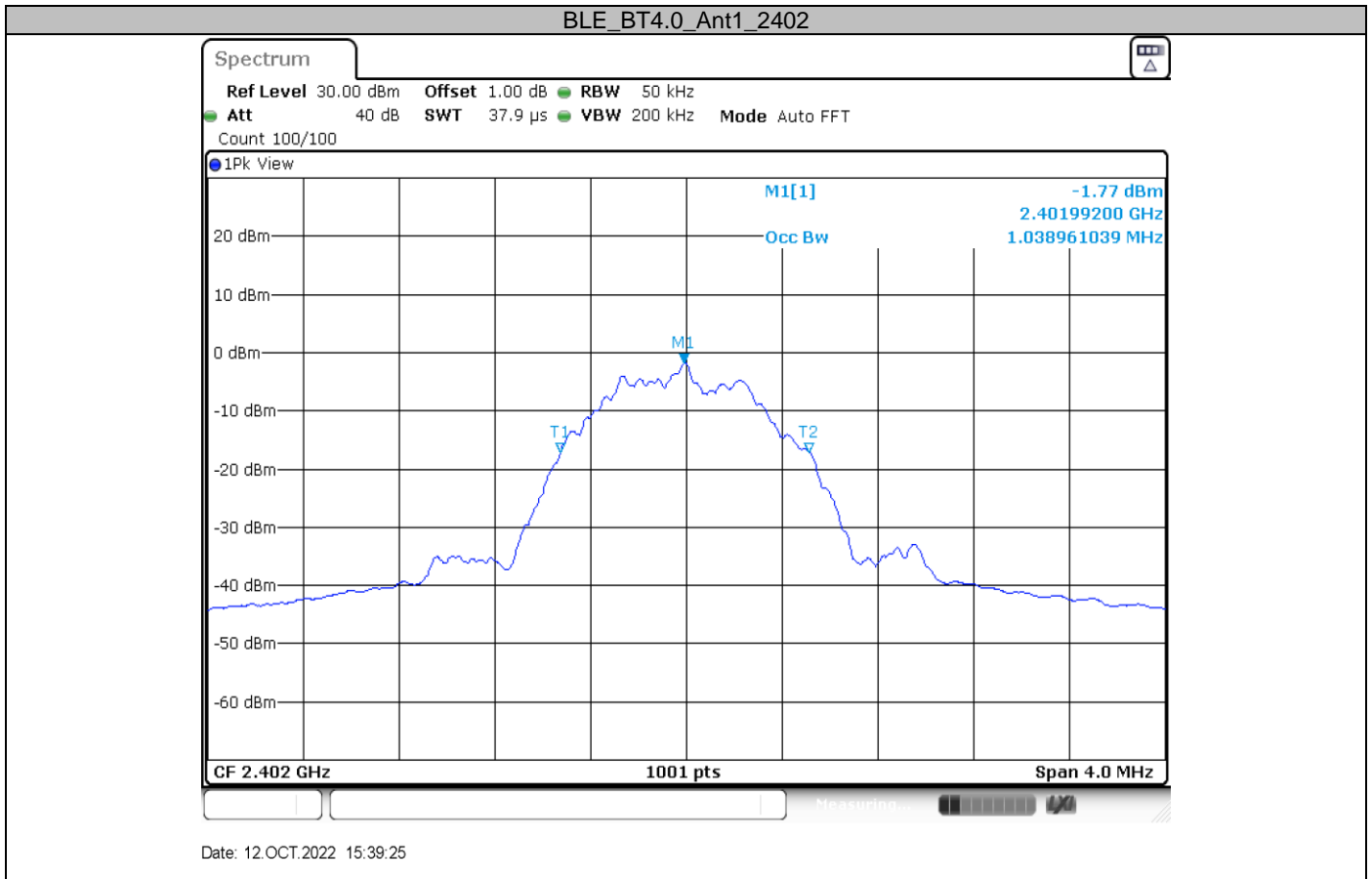

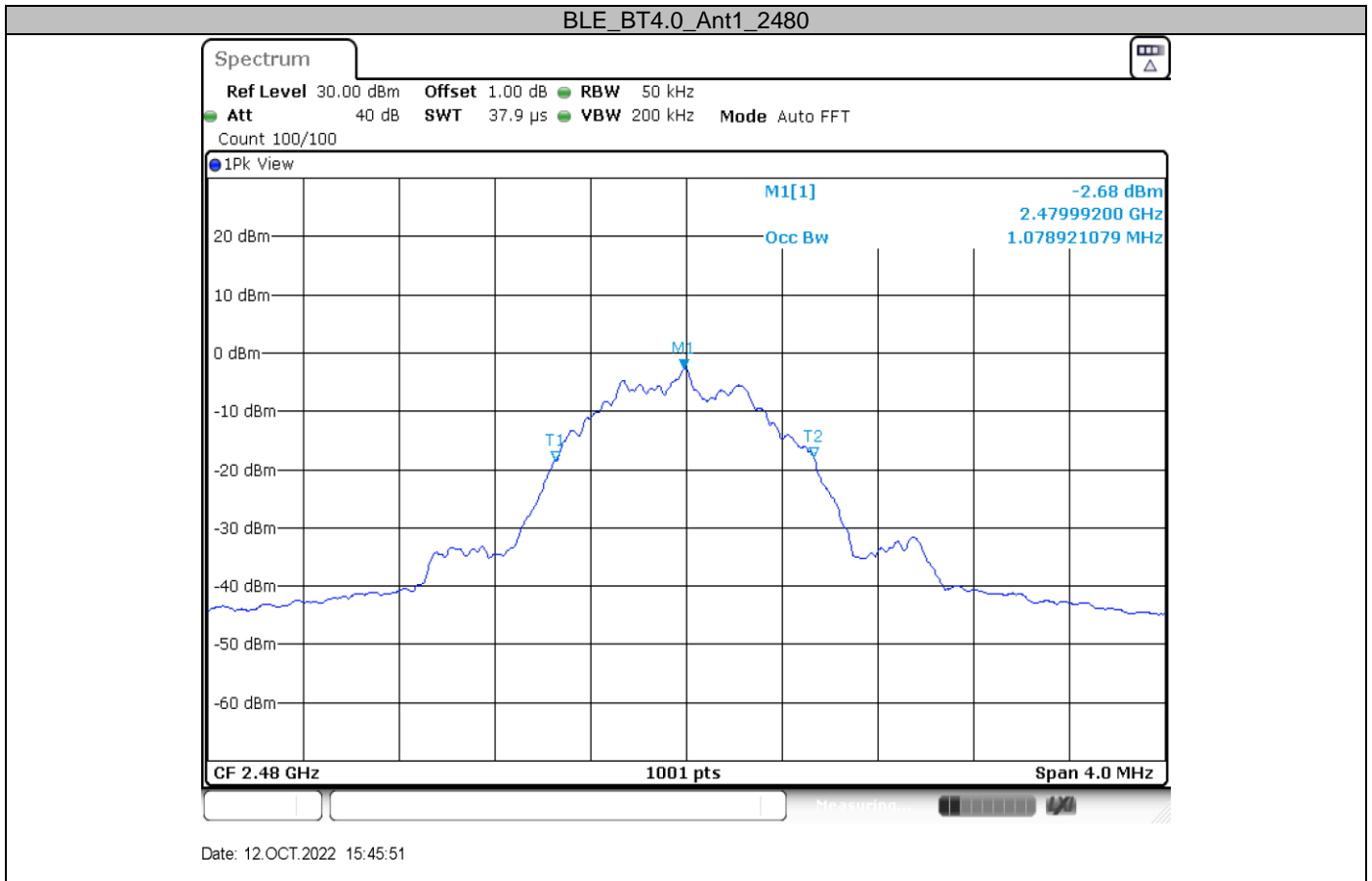

9.5 Spurious RF Conducted Emissions

Test Method

1. The RF output of EUT was connected to the spectrum analyzer by RF cable. The path loss was compensated to the results for each measurement.
2. Set to the maximum power setting and enable the EUT transmit continuously.
3. Set RBW = 100 kHz, VBW=300 kHz, Peak Detector. Unwanted Emissions measured in any 100 kHz bandwidth outside of the authorized frequency band shall be attenuated by at least 20 dB relative to the maximum in-band peak PSD level in 100 kHz when maximum peak conducted output power procedure is used. If the transmitter complies with the conducted power limits based on the use of RMS averaging over a time interval, the attenuation required under this paragraph shall be 30 dB instead of 20 dB.
4. Measure and record the results in the test report.
5. The RF fundamental frequency should be excluded against the limit line in the operating frequency

Limit

Frequency Range MHz	Limit (dBc)
30-25000	-20

Spurious RF conducted emissions

Test Mode	Antenna	Channel (MHz)	Frequency Range (MHz)	Reference Level	Result (dBm)	Limit (dBm)	Verdict
BLE_1M	Ant0	2402	Reference	-0.93	-0.93	---	PASS
			30~1000	30~1000	-53	<=-20.93	PASS
			1000~26500	1000~26500	-39.01	<=-20.93	PASS
		2440	Reference	-1.34	-1.34	---	PASS
			30~1000	30~1000	-52.45	<=-21.34	PASS
			1000~26500	1000~26500	-39.09	<=-21.34	PASS
		2480	Reference	-1.89	-1.89	---	PASS
			30~1000	30~1000	-52.24	<=-21.89	PASS
			1000~26500	1000~26500	-47.78	<=-21.89	PASS

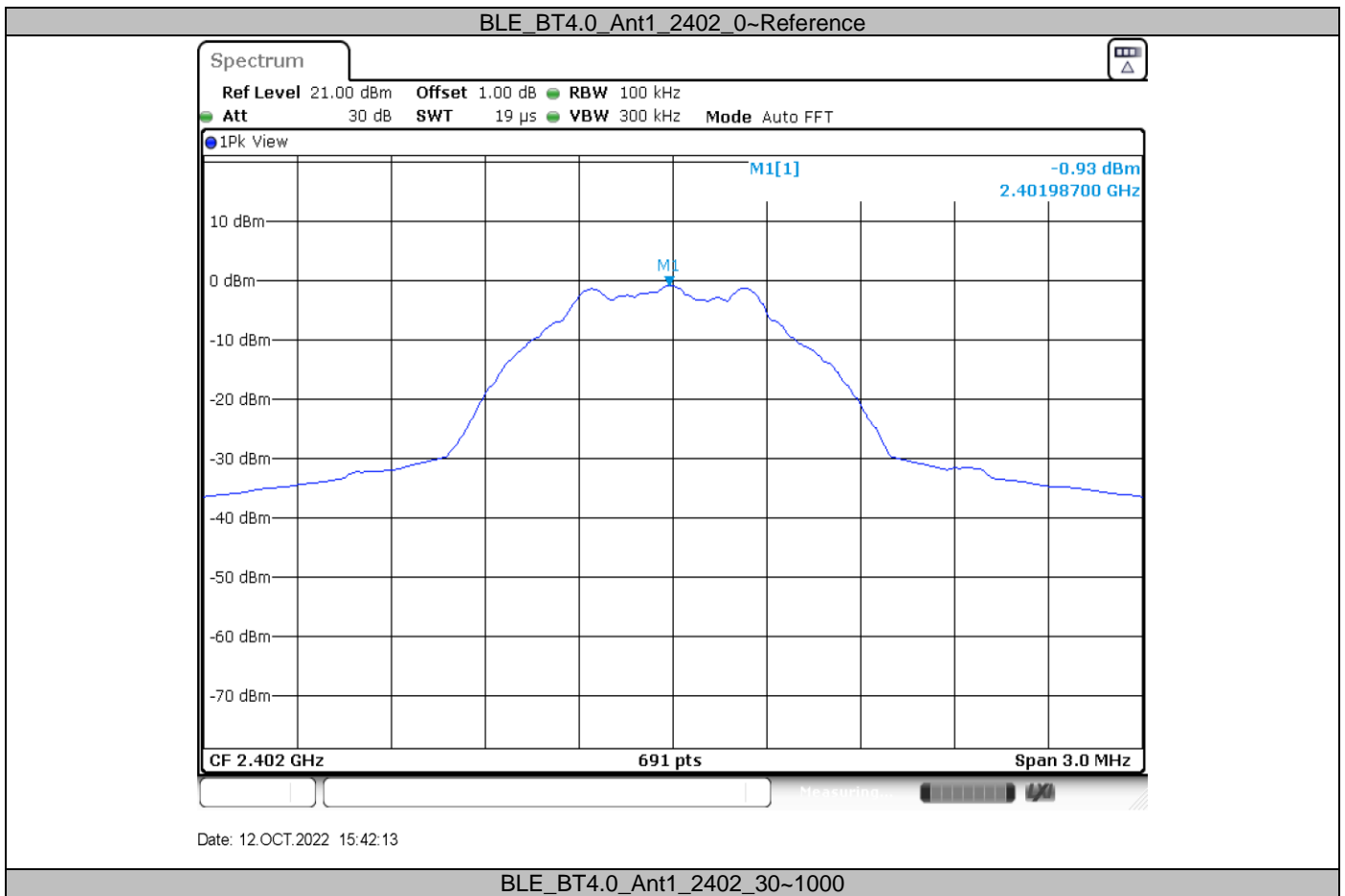

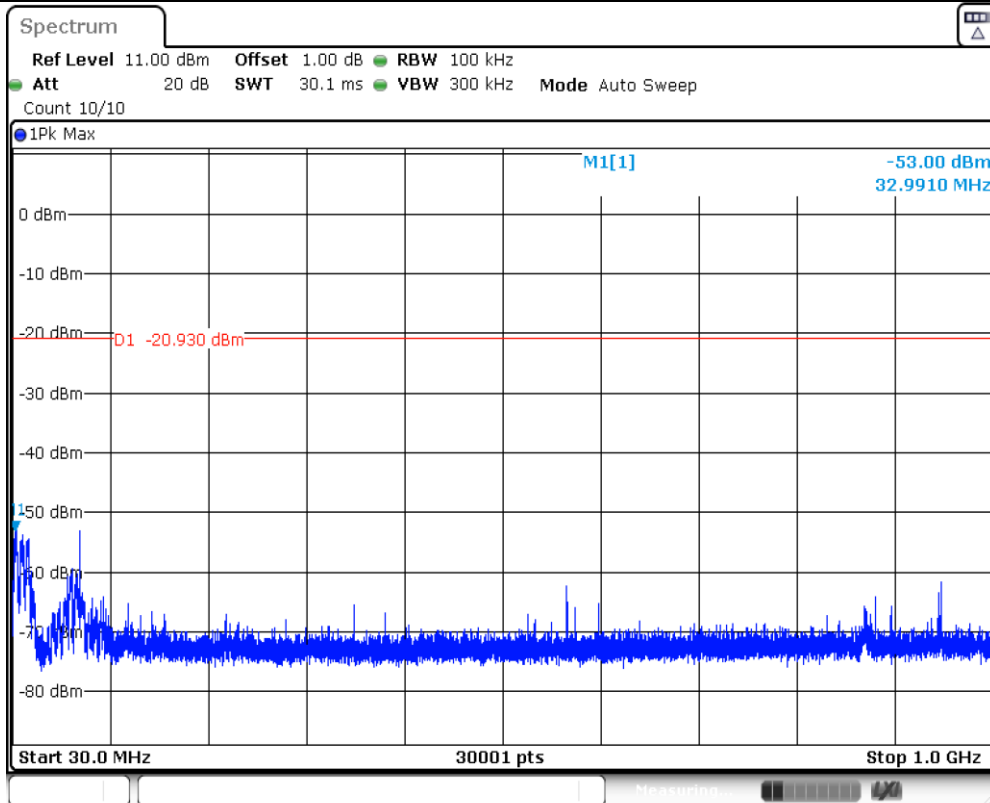

Date: 12.OCT.2022 15:42:19

BLE_BT4.0_Ant1_2402_1000~26500

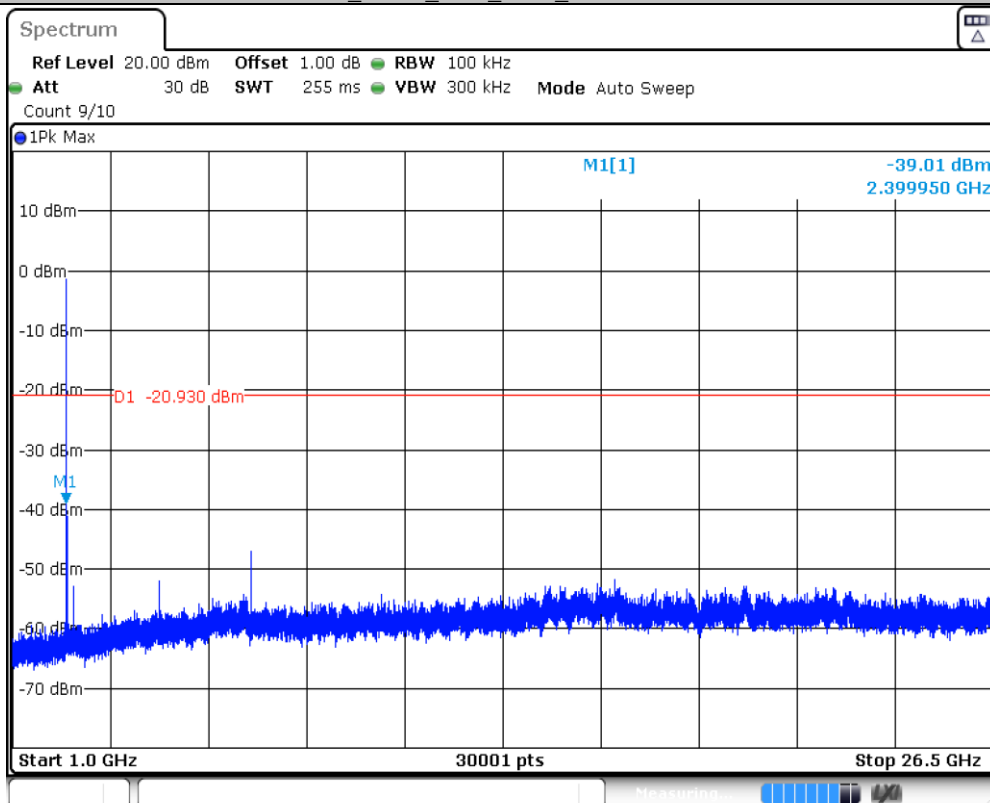

Date: 12.OCT.2022 15:42:27

BLE_BT4.0_Ant1_2440_0-Reference

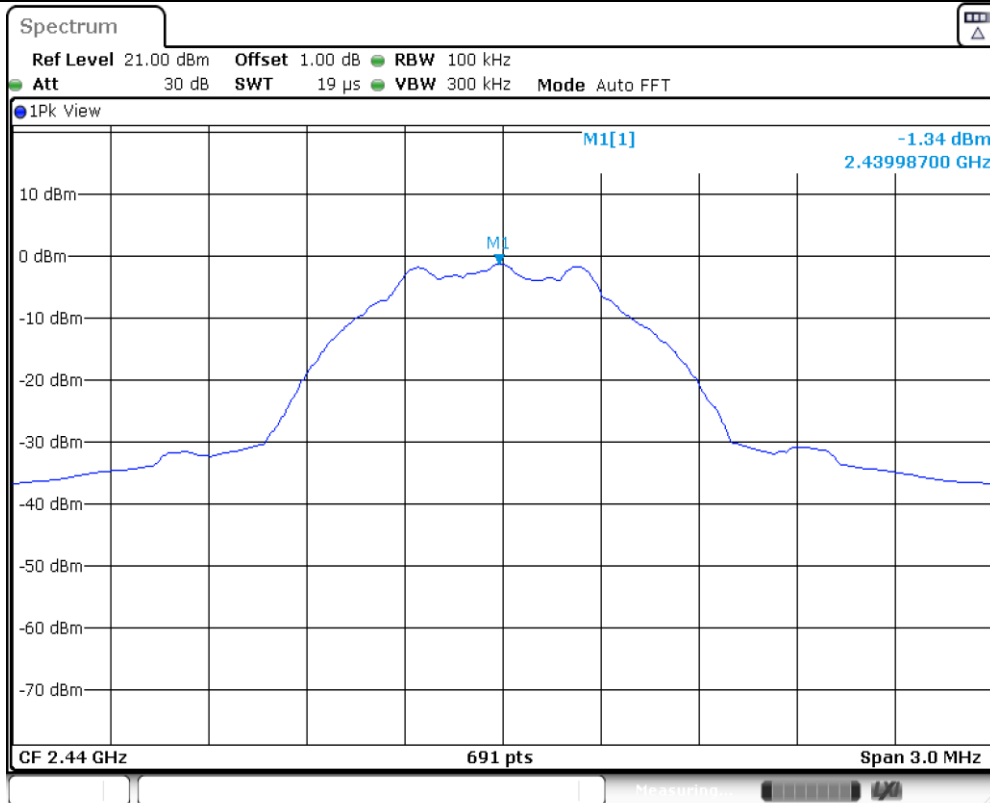

Date: 12.OCT.2022 15:44:09

BLE_BT4.0_Ant1_2440_30~1000

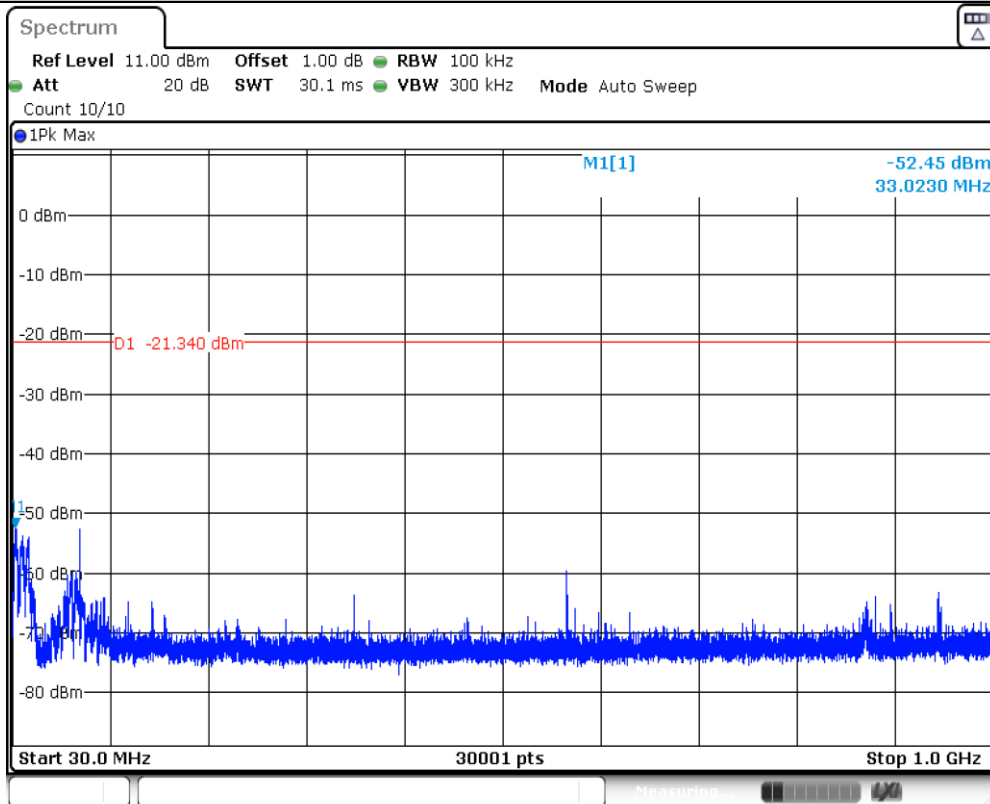

Date: 12.OCT.2022 15:44:15

BLE_BT4.0_Ant1_2440_1000~26500

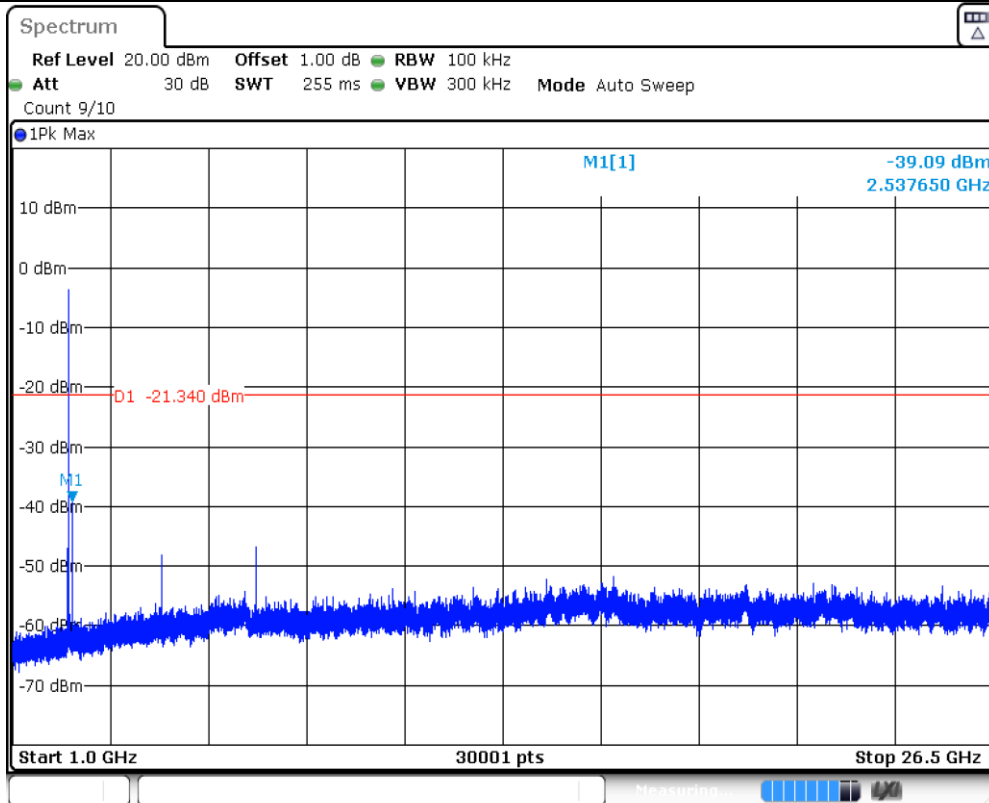

Date: 12.OCT.2022 15:44:23

BLE_BT4.0_Ant1_2480_0~Reference

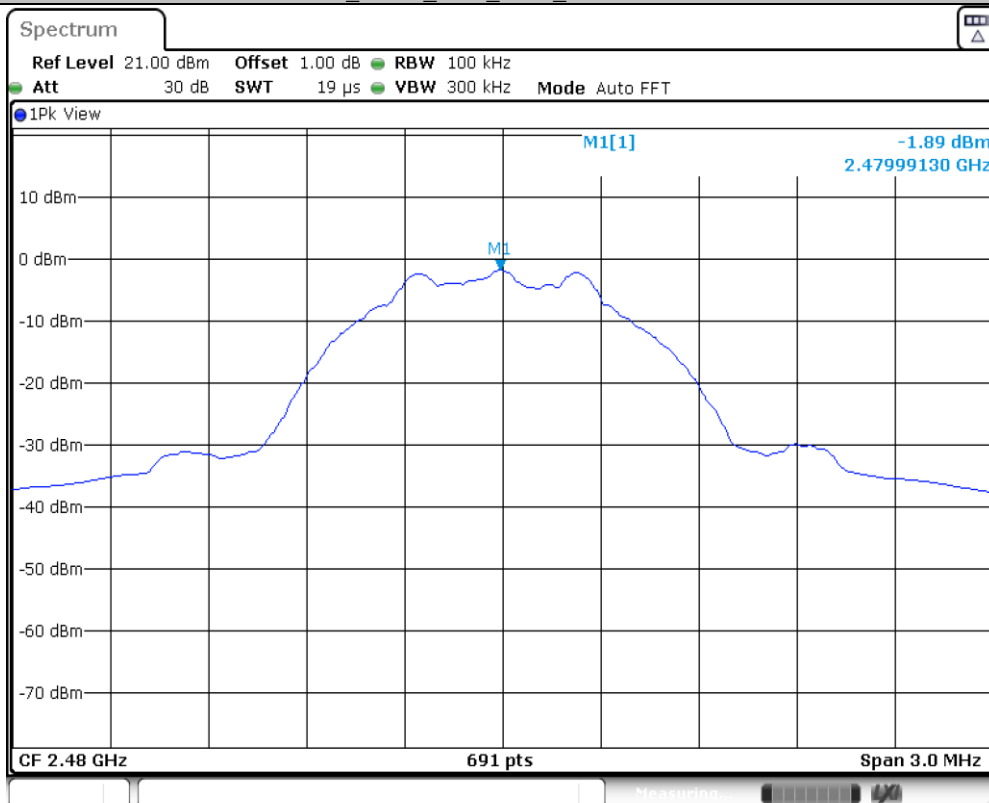

Date: 12.OCT.2022 15:46:18

BLE_BT4.0_Ant1_2480_30~1000

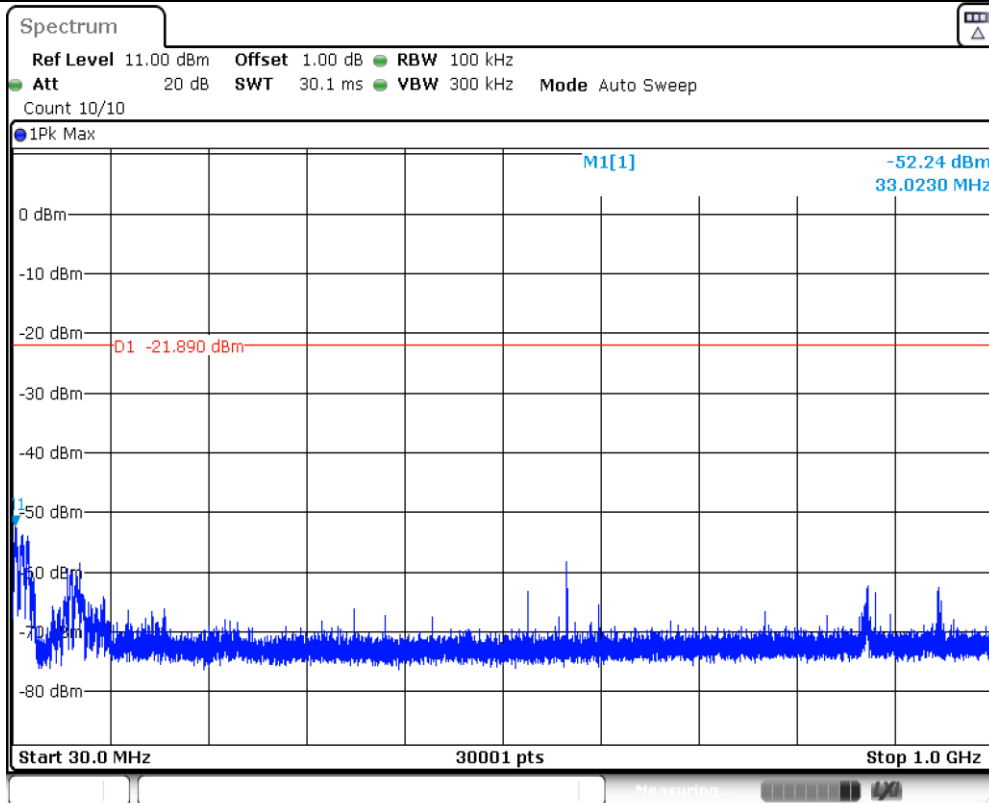

Date: 12.OCT.2022 15:46:24

BLE_BT4.0_Ant1_2480_1000~26500

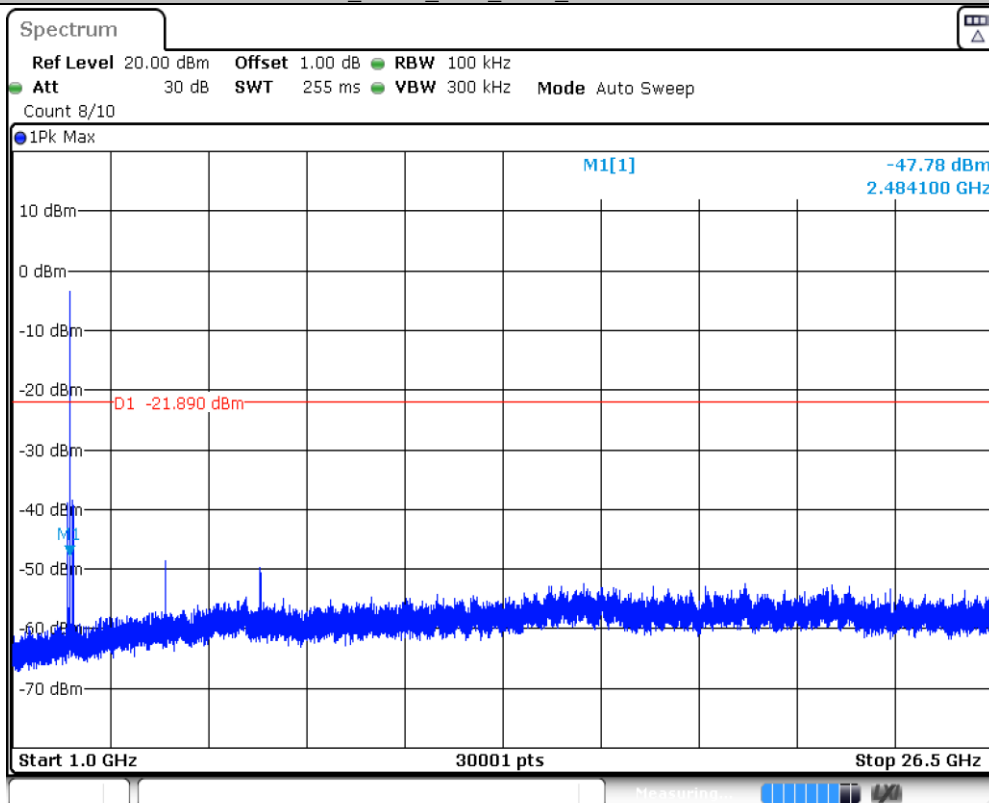

Date: 12.OCT.2022 15:46:32

9.6 Band Edge

Test Method

1. The RF output of EUT was connected to the spectrum analyzer by RF cable. The path loss was compensated to the results for each measurement.
2. Set to the maximum power setting and enable the EUT transmit continuously.
3. Set RBW = 100 kHz, VBW=300 kHz, Peak Detector. Unwanted Emissions measured in any 100 kHz bandwidth outside of the authorized frequency band shall be attenuated by at least 20 dB relative to the maximum in-band peak PSD level in 100 kHz when maximum peak conducted output power procedure is used. If the transmitter complies with the conducted power limits based on the use of RMS averaging over a time interval, the attenuation required under this paragraph shall be 30 dB instead of 20 dB.
4. Measure and record the results in the test report.
5. The RF fundamental frequency should be excluded against the limit line in the operating frequency
6. Set to the maximum power setting and enable the EUT hopping mode, repeat the test.

Limit

Frequency Range MHz	Limit (dBc)
30-25000	-20

Band edge testing

Test Mode	Antenna	Channel	Channel (MHz)	Reference Level (dBm)	Result (dBm)	Limit (dBm)	Verdict
BLE_1M	Ant0	Low	2402	-0.91	-40.38	<=-20.91	PASS
		High	2480	-2.08	-44.08	<=-22.08	PASS

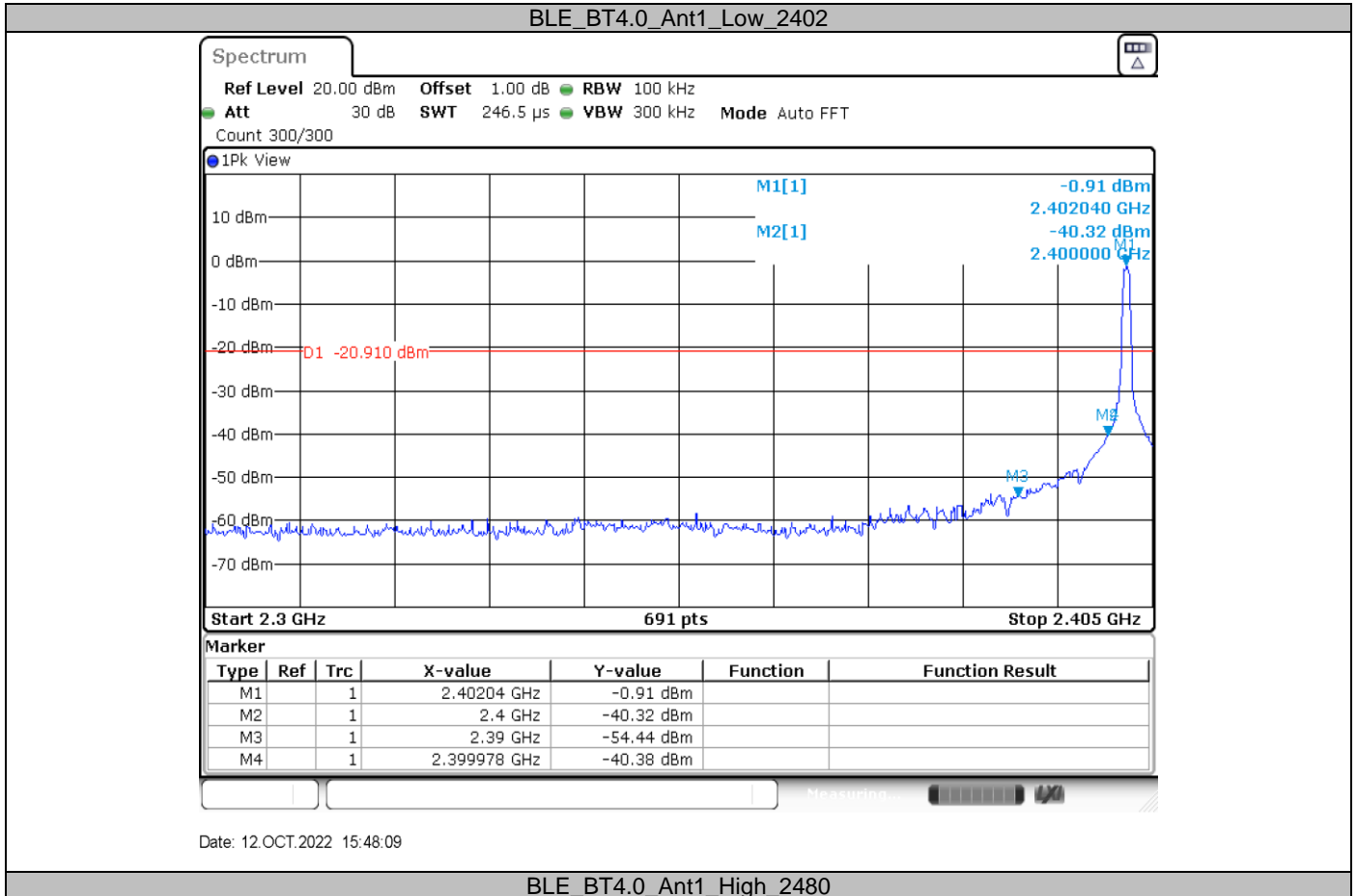

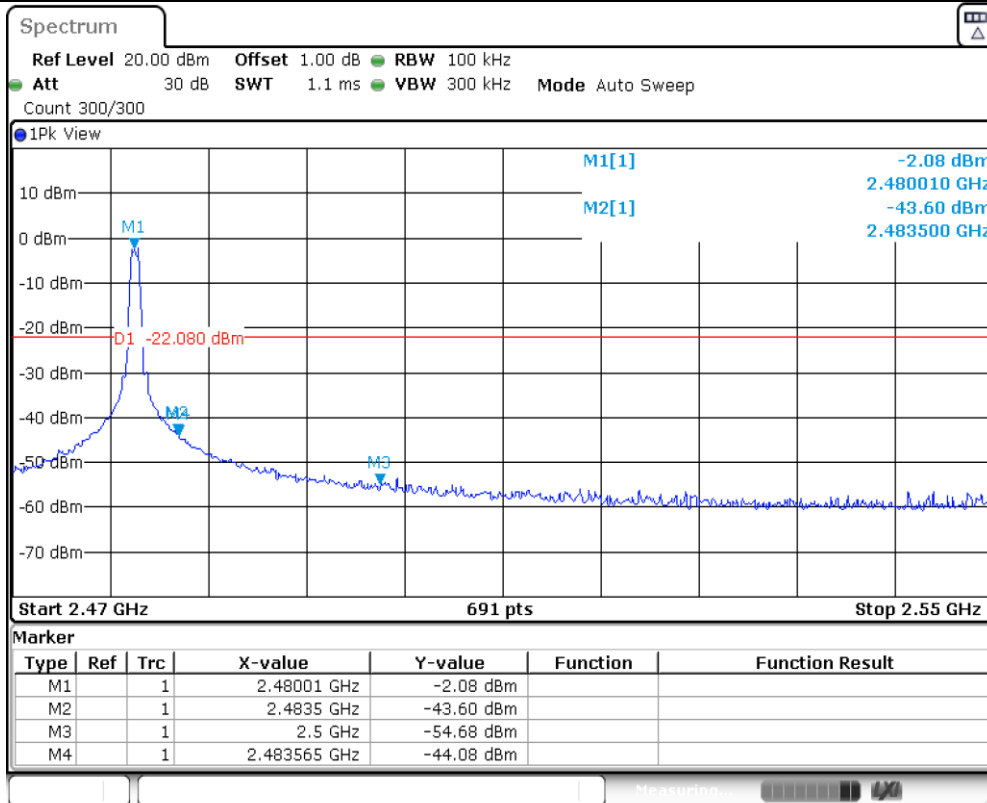

Date: 12.OCT.2022 15:47:27

9.7 Spurious Radiated Emissions for Transmitter

Test Method

1. The EUT was placed on a turn table which is 1.5m above ground plane for above 1GHz and 0.8m above ground for below 1GHz at 3 meters chamber room for test. The table was rotated 360 degrees to determine the position of the highest radiation.
2. Set to the maximum power setting and enable the EUT transmit continuously
3. The EUT was set 3 meters away from the interference – receiving antenna, which was mounted on the top of a variable – height antenna tower.
4. The height of antenna is varied from one meter to four meters above the ground to determine the maximum value of the field strength. Both horizontal and vertical polarizations of the antenna are set to make the measurement.
5. For each suspected emission, the EUT was arranged to its worst case and then the antenna was tuned to heights from 1 meter to 4 meters and the rotatable table was turned from 0 degrees to 360 degrees to find the maximum reading.
6. Use the following spectrum analyzer settings According to C63.10:
 - (1) Span shall wide enough to fully capture the emission being measured;
 - (2) Set RBW=100 kHz, VBW= 300KHz for $f < 1$ GHz; Sweep = auto; Detector function = peak; Trace = max hold;
 - (3) Set RBW=1 MHz, VBW= 3MHz for $f \geq 1$ GHz for peak measurement.For average measurement:
VBW = 10 Hz, when duty cycle is no less than 98 percent.
VBW $\geq 1/T$, when duty cycle is less than 98 percent where T is the minimum transmission duration over which the transmitter is on and is transmitting at its maximum power control level for the tested mode of operation.
7. Repeat above procedures until all frequencies measured were complete.

Note:

- 1: The resolution bandwidth and video bandwidth of test receiver/spectrum analyzer is 120 KHz for Quasi-peak detection (QP) at frequency below 1GHz.
- 2: The resolution bandwidth of test receiver/spectrum analyzer is 1MHz and the video bandwidth is 3MHz for peak detection (PK) at frequency above 1GHz.
- 3: The resolution bandwidth of test receiver/spectrum analyzer is 1MHz and the video bandwidth is 3MHz for RMS Average ((duty cycle < 98%) for Average detection (AV) at frequency above 1GHz, then the measurement results was added to a correction factor ($20\log(1/\text{duty cycle})$).
- 4: The resolution bandwidth of test receiver/spectrum analyzer is 1MHz and the video bandwidth is 10Hz (duty cycle > 98%) for Average detection (AV) at frequency above 1GHz.

Spurious radiated emissions for transmitter

Limit

The radio emission outside the operating frequency band shall be at least 20 dB below that in the 100 kHz bandwidth within the band that contains the highest level of the desired power. Radiated emissions which fall in the restricted bands, as defined in section 15.205 & RSS-GEN 8.10, must comply with the radiated emission limits specified in section 15.209 & RSS-Gen 6.13.

Frequency MHz	Field Strength $\mu\text{V/m}$	Field Strength $\text{dB}\mu\text{V/m}$	Detector
30-88	100	40	QP
88-216	150	43.5	QP
216-960	200	46	QP
960-1000	500	54	QP
Above 1000	500	54	AV
Above 1000	5000	74	PK

Spurious radiated emissions for transmitter

According to C63.10, if the peak (or quasi-peak) measured value complies with the average limit, it is unnecessary to perform an average measurement, so AV emission value did not show in below table if the peak value complies with average limit.

Product Type : MOTHER Bracelet
 M/N : MBMMSC
 Operating Condition : Transmitting 2402MHz
 Frequency Band : 9KHz-1000MHz

Frequency Band	Frequency	Emission Level	Polarization	Limit	Detector	Margin	Correct factor	Result
	MHz	dB μ V/m		dB μ V/m		dB μ V/m	(dB/m)	
9KHz-1000MHz	45.627778	21.28	H	40.00	QP	18.72	20.82	Pass
	55.273889	20.92	H	40.00	QP	19.08	20.41	Pass
	102.049444	19.37	H	43.50	QP	24.13	18.52	Pass
	220.497222	22.44	H	46.00	QP	23.56	18.65	Pass
	419.616667	27.42	H	46.00	QP	18.58	24.01	Pass
	906.179444	35.40	H	46.00	QP	10.60	31.83	Pass
	Other Frequencies	--	H	--	QP	--	--	Pass
	47.244444	21.37	V	40.00	QP	18.63	20.93	Pass
	100.055556	19.39	V	43.50	QP	24.11	18.32	Pass
	197.109444	19.97	V	43.50	QP	23.53	18.85	Pass
	396.175000	26.48	V	46.00	QP	19.52	23.55	Pass
	683.995556	33.11	V	46.00	QP	12.89	28.63	Pass
	945.572222	37.98	V	46.00	QP	8.02	31.76	Pass
Other Frequencies	--	V	--	QP	--	--	Pass	

Product Type : MOTHER Bracelet
 M/N : MBMMSC
 Operating Condition : Transmitting 2402MHz
 Frequency Band : 1GHz-25GHz

Frequency Band	Frequency	Emission Level	Polarization	Limit	Detector	Margin	Correct factor	Result
	MHz	dB μ V/m		dB μ V/m		dB μ V/m	(dB/m)	
1000-25000MHz	2046.500000	41.71	H	74	PK	32.29	-3.88	Pass
	*4072.500000	47.63	H	74	PK	26.37	1.90	Pass
	6393.500000	47.80	H	74	PK	26.20	9.29	Pass
	Other Frequencies	--	H	--	PK	--	--	Pass
	*1587.500000	38.77	V	74	PK	35.23	-7.99	Pass
	2391.500000	46.07	V	74	PK	27.93	-2.89	Pass
	6386.500000	49.01	V	74	PK	24.99	9.34	Pass
	Other Frequencies	--	V	--	PK	--	--	Pass

Product Type : MOTHER Bracelet
 M/N : MBMMSC
 Operating Condition : Transmitting 2440MHz
 Frequency Band : 1GHz-25GHz

Frequency Band	Frequency	Emission Level	Polarization	Limit	Detector	Margin	Correct factor	Result
	MHz	dBµV/m		dBµV/m		dBµV/m	(dB/m)	
1000-25000MHz	*1594.000000	39.09	H	74	PK	34.91	-7.96	Pass
	4400.500000	48.04	H	74	PK	25.96	2.85	Pass
	7791.500000	43.02	H	74	PK	30.98	9.99	Pass
	Other Frequencies	--	H	--	PK	--	--	Pass
	1786.000000	40.23	V	74	PK	33.77	-6.03	Pass
	3194.000000	45.84	V	74	PK	28.16	-0.68	Pass
	6379.000000	46.76	V	74	PK	27.24	9.39	Pass
	Other Frequencies	--	V	--	PK	--	--	Pass

Product Type : MOTHER Bracelet
 M/N : MBMMSC
 Operating Condition : Transmitting 2480MHz
 Frequency Band : 1GHz-25GHz

Frequency Band	Frequency	Emission Level	Polarization	Limit	Detector	Margin	Correct factor	Result
	MHz	dBµV/m		dBµV/m		dBµV/m	(dB/m)	
1000-25000MHz	*1587.500000	38.44	H	74	PK	35.56	-7.99	Pass
	3100.500000	43.01	H	74	PK	30.99	-0.67	Pass
	*7605.000000	44.03	H	74	PK	29.97	10.50	Pass
	Other Frequencies	--	H	--	PK	--	--	Pass
	*2254.500000	42.97	V	74	PK	31.03	-3.73	Pass
	*4144.000000	45.68	V	74	PK	28.32	2.11	Pass
	6385.000000	47.20	V	74	PK	26.80	9.35	Pass
	Other Frequencies	--	V	--	PK	--	--	Pass

Remark:

- (1) "*" means the emission(s) appear within the restrict bands shall follow the requirement of section 15.205 & RSS-GEN 8.10.
- (2) Data of measurement within this frequency range shown "--" in the table above means the reading of emissions are the noise floor or the field strength is too small to be measured.
- (3) Corrected Amplitude = Read level + Corrector factor
 Above 1GHz: Corrector factor = Antenna Factor + Cable Loss- Amplifier Gain
 Below 1GHz: Corrector factor = Antenna Factor + Cable Loss
 (The Reading Level is recorded by software which is not shown in the sheet)

10 Test Equipment List

List of Test Instruments

Radiated Emission Test

DESCRIPTION	MANUFACTURER	MODEL NO.	EQUIPMENT ID	SERIAL NO.	CAL INTERVAL (YEAR)	CAL. DUE DATE
EMI Test Receiver	Rohde & Schwarz	ESR 26	68-4-74-14-002	101269	1	2023-5-28
Trilog Super Broadband Test Antenna	Schwarzbeck	VULB 9162	68-4-80-19-003	284	1	2023-1-17
Wave Guide Antenna	ETS	3117	68-4-80-19-001	00218954	1	2023-5-9
Pre-amplifier	Rohde & Schwarz	SCU 18F	68-4-29-19-001	100745	1	2023-5-28
Pre-amplifier	Rohde & Schwarz	SCU 18F	68-4-29-19-002	100746	1	2023-5-28
Sideband Horn Antenna	Q-PAR	QWH-SL-18-40-K-SG	68-4-80-14-008	12827	1	2023-7-12
Pre-amplifier	Rohde & Schwarz	SCU 40A	68-4-29-14-002	100432	1	2023-7-27
Attenuator	Mini-circuits	UNAT-6+	68-4-81-21-002	15542	1	2023-5-27
3m Semi-anechoic chamber	TDK	SAC-3 #2	68-4-90-19-006	----	2	2023-5-28
Test software	Rohde & Schwarz	EMC32	68-4-90-19-006-A01	Version10.35.02	N/A	N/A

Conducted Emission Test

DESCRIPTION	MANUFACTURER	MODEL NO.	EQUIPMENT ID	SERIAL NO.	CAL INTERVAL (YEAR)	CAL. DUE DATE
EMI Test Receiver	Rohde & Schwarz	ESR 3	68-4-74-19-002	102590	1	2023-5-27
LISN	Rohde & Schwarz	ENV216	68-4-87-19-001	102472	1	2023-5-27
ISN	Rohde & Schwarz	ENY81	68-4-87-14-003	100177	1	2023-5-27
ISN	Rohde & Schwarz	ENY81-CA6	68-4-87-14-004	101664	1	2023-5-27
High Voltage Probe	Schwarzbeck	TK9420(VT9420)	68-4-27-14-001	9420-584	1	2023-5-27
RF Current Probe	Rohde & Schwarz	EZ-17	68-4-27-14-002	100816	1	2023-5-31
Attenuator	Shanghai Huaxiang	TS2-26-3	68-4-81-16-003	080928189	1	2023-5-27
Test software	Rohde & Schwarz	EMC32	68-4-90-19-005-A01	Version10.35.02	N/A	N/A
Shielding Room	TDK	CSR #2	68-4-90-19-005	----	3	2025-10-15

Conducted RF Test System

DESCRIPTION	MANUFACTURER	MODEL NO.	EQUIPMENT ID	SERIAL NO.	CAL INTERVAL (YEAR)	CAL. DUE DATE
Signal Analyzer	Rohde & Schwarz	FSV40	68-4-74-14-004	101030	1	2023-5-27
RF Switch Module	Rohde & Schwarz	OSP120/OSP-B157	68-4-93-14-003	101226/100851	1	2023-5-27
Power Splitter	Weinschel	1580	68-4-85-14-001	SC319	1	2023-5-28
Test software	Tonscend	System for BT/WIFI	68-4-74-14-006-A13	Version 2.6.77.0518	N/A	N/A
Shielding Room	TDK	TS8997	68-4-90-19-003	----	3	2022-11-07

11 System Measurement Uncertainty

For a 95% confidence level, the measurement expanded uncertainties for defined systems, in accordance with the recommendations of ISO 17025 were:

System Measurement Uncertainty	
Test Items	Extended Uncertainty
Uncertainty for Conducted Emission in new shielding room 150kHz-30MHz (for test using AMN ENV216)	3.33dB
Uncertainty for Radiated Emission in new 3m chamber (68-4-90-19-006) 30MHz-1000MHz	Horizontal: 4.59dB; Vertical: 4.75dB;
Uncertainty for Radiated Emission in new 3m chamber (68-4-90-19-006) 1000MHz-18000MHz	Horizontal: 5.08dB; Vertical: 5.09dB;
Uncertainty for Radiated Emission 18000MHz-40000MHz	Horizontal: 4.51dB; Vertical: 4.50dB;
Uncertainty for Conducted RF test	RF Power Conducted: 1.30dB Frequency test involved: 0.6×10^{-8} or 1%

Measurement Uncertainty Decision Rule:

Determination of conformity with the specification limits is based on the decision rule according to IEC Guide 115: 2007, clause 4.4.3 and 4.5.1.

THE END