



Shenzhen CTA Testing Technology Co., Ltd.

Room 106, Building 1, Yibaolai Industrial Park, Qiaotou Community, Fuhai Street, Bao'an District, Shenzhen, China

FCC PART 22/24 TEST REPORT

FCC Part 22 /Part 24

Report Reference No.....: CTA24041700504

FCC ID.....: 2A8ZB-G232

Compiled by (position+printed name+signature)...: File administrators Jinghua Xiao

Supervised by (position+printed name+signature)...: Project Engineer Zoey Cao

Approved by (position+printed name+signature)...: RF Manager Eric Wang

Date of issue.....: May. 13, 2024

Testing Laboratory Name: Shenzhen CTA Testing Technology Co., Ltd.

Address: Room 106, Building 1, Yibaolai Industrial Park, Qiaotou Community, Fuhai Street, Bao'an District, Shenzhen, China

Applicant's name: Shenzhen Weiwo Intelligent Electronics Co., Ltd

Address: Floor 2, building A7, No. 416, Xuegang North Road, Qinghu community, Longhua street, Longhua District, Shenzhen, China

Test specification

Standard: FCC Part 22: PUBLIC MOBILE SERVICES

FCC Part 24: PERSONAL COMMUNICATIONS SERVICES

Shenzhen CTA Testing Technology Co., Ltd. All rights reserved.

This publication may be reproduced in whole or in part for non-commercial purposes as long as the Shenzhen CTA Testing Technology Co., Ltd. is acknowledged as copyright owner and source of the material. Shenzhen CTA Testing Technology Co., Ltd. takes no responsibility for and will not assume liability for damages resulting from the reader's interpretation of the reproduced material due to its placement and context.

Test item description: 4G smartwatch

Trade Mark: N/A

Manufacturer: Shenzhen Weiwo Intelligent Electronics Co., Ltd

Model/Type reference.....: G232

Listed Models: Refer to page 2

Frequency.....: GSM 850MHz; PCS 1900MHz;

Modulation: GMSK

GPRS.....: Supported

Ratings: DC 3.85V From battery and DC 5.0V From external circuit

Result.....: PASS



TEST REPORT

Equipment under Test : 4G smartwatch

Model /Type : G232

Listed Models : G130, G131, G132, G133, G134, G135, G136, G137, G138, G139, G140, G141, G142, G143, G144, G145, G146, G147, G148, G149, G150, G230, G231, G233, G234, G235, G236, G237, G238, G239, G240, G241, G242, G243, G245, G246, G247, G248, G249, G250, G251, G252, G253, G254, G255, G256, G257, G258, G259, G260

Applicant : **Shenzhen Weiwo Intelligent Electronics Co., Ltd**

Address : Floor 2, building A7, No. 416, Xuegang North Road, Qinghu community, Longhua street, Longhua District, Shenzhen, China

Manufacturer : **Shenzhen Weiwo Intelligent Electronics Co., Ltd**

Address : Floor 2, building A7, No. 416, Xuegang North Road, Qinghu community, Longhua street, Longhua District, Shenzhen, China

Test Result:	PASS
---------------------	-------------

The test report merely corresponds to the test sample.
It is not permitted to copy extracts of these test result without the written permission of the test laboratory.

Contents

1	<u>TEST STANDARDS</u>	<u>4</u>
2	<u>SUMMARY</u>	<u>5</u>
2.1	General Remarks	5
2.2	Product Description	5
2.3	Equipment under Test	5
2.4	Short description of the Equipment under Test (EUT)	6
2.5	EUT configuration	6
2.6	Related Submittal(s) / Grant (s)	6
2.7	Modifications	6
2.8	General Test Conditions/Configurations	6
2.9	Modifications	6
3	<u>TEST ENVIRONMENT</u>	<u>7</u>
3.1	Address of the test laboratory	7
3.2	Test Facility	7
3.3	Environmental conditions	7
3.4	Test Description	7
3.5	Equipments Used during the Test	9
4	<u>TEST CONDITIONS AND RESULTS</u>	<u>11</u>
4.1	Output Power	11
4.2	Radiated Spurious Emission	15
4.3	Occupied Bandwidth and Emission Bandwidth	18
4.4	Band Edge Complicance	22
4.5	Spurious Emission on Antenna Port	25
4.6	Frequency Stability Test	33
4.7	Peak-to-Average Ratio (PAR)	36
5	<u>TEST SETUP PHOTOS OF THE EUT</u>	<u>39</u>
6	<u>EXTERNAL AND INTERNAL PHOTOS OF THE EUT</u>	<u>39</u>

1 TEST STANDARDS

The tests were performed according to following standards:

[FCC Part 2](#): FREQUENCY ALLOCATIONS AND RADIO TREATY MATTERS; GENERAL RULES AND REGULATIONS

[FCC Part 22 Subpart H](#): PRIVATE LAND MOBILE RADIO SERVICES.

[FCC Part 24 Subpart E](#): PUBLIC MOBILE SERVICES

[ANSI/TIA-603-E-2016](#): Land Mobile FM or PM Communications Equipment Measurement and Performance Standards.

[ANSI C63.26-2015](#): IEEE/ANSI Standard for Compliance Testing of Transmitters Used in Licensed Radio Services

[FCC KDB971168D01](#) Power Meas License Digital Systems

2 SUMMARY

2.1 General Remarks

Date of receipt of test sample	:	Apr. 01, 2024
Testing commenced on	:	Apr. 01, 2024
Testing concluded on	:	May. 13, 2024

2.2 Product Description

Product Name:	4G smartwatch
Model/Type reference:	G232
Power supply:	DC 3.85V From battery and DC 5.0V From external circuit
Adapter information (Auxiliary test supplied by test Lab):	Model: EP-TA20CBC Input: AC 100-240V 50/60Hz Output: DC 5V 2A
Hardware version:	C16_V1.5
Software version:	G232_32_EN_V2.5_20240403
testing sample ID:	CTA240417005-1# (Engineer sample) CTA240417005-2# (Normal sample)
Modulation Type	GMSK
Antenna Type	PIFA Antenna
GSM/EDGE/GPRS	Supported GSM/GPRS
GSM/GPRS Power Class	GSM850:Power Class 4/ PCS1900:Power Class 1
GSM/GPRS Operation Frequency	GSM850 :824.2MHz-848.8MHz/PCS1900:1850.2MHz-1909.8MHz
GPRS Operation Frequency Band	GPRS850/GPRS1900
GPRS Multislot Class	Multi-slot Class 12
Extreme temp. Tolerance	-30°C to +50°C
GPRS operation mode	Class B
Antenna gain:	GSM850:1.0 dbi,DCS1900: 1.0dbi

2.3 Equipment under Test

Power supply system utilised

Power supply voltage	:	<input type="radio"/> 120V / 60 Hz	<input type="radio"/> 230V / 50Hz
		<input type="radio"/> 12 V DC	<input type="radio"/> 24 V DC
		<input checked="" type="radio"/> Other (specified in blank below)	

DC 3.85V From battery and DC 5.0V From external circuit

Test frequency list

Test Mode	TX/RX	RF Channel		
		Low(L)	Middle (M)	High (H)
GPRS 850	TX	Channel 128	Channel 190	Channel 251
		824.2 MHz	836.6 MHz	848.8 MHz
	RX	Channel 128	Channel 190	Channel 251
		869.2 MHz	881.6 MHz	893.8 MHz
Test Mode	TX/RX	RF Channel		
		Low(L)	Middle (M)	High (H)
GPRS 1900	TX	Channel 512	Channel 661	Channel 810
		1850.2 MHz	1880.0 MHz	1909.8 MHz
	RX	Channel 512	Channel 661	Channel 810
		1930.2 MHz	1960.0 MHz	1989.8 MHz

2.4 Short description of the Equipment under Test (EUT)

This is a 4G smartwatch.

For more details, refer to the user's manual of the EUT.

2.5 EUT configuration

The following peripheral devices and interface cables were connected during the measurement:

- supplied by the manufacturer
- supplied by the lab

<input type="radio"/> /	M/N : /
	Manufacturer: /

2.6 Related Submittal(s) / Grant (s)

This submittal(s) (test report) is filing to comply with FCC Part 22 and Part 24 Rules

2.7 Modifications

No modifications were implemented to meet testing criteria.

2.8 General Test Conditions/Configurations

2.8.1 Test Modes

NOTE: The test mode(s) are selected according to relevant radio technology specifications.

Test Mode 1	GSM
Test Mode 2	GPRS

2.8.2 Test Environment

Environment Parameter	Selected Values During Tests	
Relative Humidity	Ambient	
Temperature	TN	Ambient
Voltage	VL	3.40V
	VN	3.85V
	VH	4.20V

NOTE: VL=lower extreme test voltage VN=nominal voltage
VH=upper extreme test voltage TN=normal temperature

2.9 Modifications

No modifications were implemented to meet testing criteria.

3 TEST ENVIRONMENT

3.1 Address of the test laboratory

Shenzhen CTA Testing Technology Co., Ltd.

Room 106, Building 1, Yibaolai Industrial Park, Qiaotou Community, Fuhai Street, Bao'an District, Shenzhen, China

3.2 Test Facility

The test facility is recognized, certified, or accredited by the following organizations:

FCC-Registration No.: 517856 Designation Number: CN1318

Shenzhen CTA Testing Technology Co., Ltd. has been listed on the US Federal Communications Commission list of test facilities recognized to perform electromagnetic emissions measurements.

A2LA-Lab Cert. No.: 6534.01

Shenzhen CTA Testing Technology Co., Ltd. has been listed by American Association for Laboratory Accreditation to perform electromagnetic emission measurement.

ISED#: 27890 CAB identifier: CN0127

Shenzhen CTA Testing Technology Co., Ltd. has been listed by Innovation, Science and Economic Development Canada to perform electromagnetic emission measurement.

The 3m-Semi anechoic test site fulfils CISPR 16-1-4 according to ANSI C63.10 and CISPR 16-1-4:2010.

3.3 Environmental conditions

During the measurement the environmental conditions were within the listed ranges:

Temperature:	15-35 ° C
Humidity:	30-60 %
Atmospheric pressure:	950-1050mbar

3.4 Test Description

3.4.1 Cellular Band (824-849MHz paired with 869-894MHz)

Test Item	FCC Rule No.	Requirements	Verdict
Effective(Isotropic) Radiated Output Power	§2.1046, §22.913	FCC: ERP ≤ 7W.	Pass
Modulation Characteristics	§2.1047	Digital modulation	N/A
Bandwidth	§2.1049	OBW: No limit. EBW: No limit.	Pass
Band Edges Compliance	§2.1051, §22.917	≤-13dBm/1%*EBW, in 1MHz bands immediately outside and adjacent to The frequency block.	Pass
Spurious Emission at Antenna Terminals	§2.1051, §22.917	FCC: ≤ -13dBm/100kHz, from 9kHz to 10th harmonics but outside authorized operating frequency ranges.	Pass
Field Strength of Spurious Radiation	§2.1053, §22.917	FCC: ≤ -13dBm/100kHz.	Pass
Frequency Stability	§2.1055, §22.355	≤ ±2.5ppm.	Pass

NOTE 1: For the verdict, the "N/A" denotes "not applicable", the "N/T" de notes "not tested".

3.4.2 PCS Band (1850-1915MHz paired with 1930-1995MHz)

Test Item	FCC Rule No.	Requirements	Verdict
Effective(Isotropic) Radiated Output Power	§2.1046, §24.232	EIRP \leq 2W	Pass
Peak-Average Ratio	§2.1046, §24.232	FCC:Limit \leq 13dB	Pass
Modulation Characteristics	§2.1047	Digital modulation	N/A
Bandwidth	§2.1049	OBW: No limit. EBW: No limit.	Pass
Band Edges Compliance	§2.1051, §24.238	\leq -13dBm/1%*EBW, In 1MHz bands immediately outside and adjacent to The frequency block.	Pass
Spurious Emission at Antenna Terminals	§2.1051, §24.238	\leq -13dBm/1MHz, from 9kHz to10th harmonics but outside authorized Operating frequency ranges.	Pass
Field Strength of Spurious Radiation	§2.1053, §24.238	\leq -13dBm/1MHz.	Pass
Frequency Stability	§2.1055, §24.235	FCC: within authorized frequency block.	Pass

NOTE 1: For the verdict, the "N/A" denotes "not applicable", the "N/T" de notes "not tested".

Remark:

1. The measurement uncertainty is not included in the test result.

3.5 Equipments Used during the Test

Test Equipment	Manufacturer	Model No.	Equipment No.	Calibration Date	Calibration Due Date
LISN	R&S	ENV216	CTA-308	2023/08/02	2024/08/01
LISN	R&S	ENV216	CTA-314	2023/08/02	2024/08/01
EMI Test Receiver	R&S	ESPI	CTA-307	2023/08/02	2024/08/01
EMI Test Receiver	R&S	ESCI	CTA-306	2023/08/02	2024/08/01
Spectrum Analyzer	Agilent	N9020A	CTA-301	2023/08/02	2024/08/01
Spectrum Analyzer	R&S	FSP	CTA-337	2023/08/02	2024/08/01
Vector Signal generator	Agilent	N5182A	CTA-305	2023/08/02	2024/08/01
Analog Signal Generator	R&S	SML03	CTA-304	2023/08/02	2024/08/01
Universal Radio Communication	CMW500	R&S	CTA-302	2023/08/02	2024/08/01
Temperature and humidity meter	Chigo	ZG-7020	CTA-326	2023/08/02	2024/08/01
Ultra-Broadband Antenna	Schwarzbeck	VULB9163	CTA-310	2021/08/07	2024/08/06
Horn Antenna	Schwarzbeck	BBHA 9120D	CTA-309	2021/08/07	2024/08/06
Loop Antenna	Zhinan	ZN30900C	CTA-311	2021/08/07	2024/08/06
Horn Antenna	Beijing Hangwei Dayang	OBH100400	CTA-336	2021/08/07	2024/08/06
Amplifier	Schwarzbeck	BBV 9745	CTA-312	2023/08/02	2024/08/01
Amplifier	Taiwan chengyi	EMC051845B	CTA-313	2023/08/02	2024/08/01
Directional coupler	NARDA	4226-10	CTA-303	2023/08/02	2024/08/01
High-Pass Filter	XingBo	XBLBQ-GTA18	CTA-402	2023/08/02	2024/08/01
High-Pass Filter	XingBo	XBLBQ-GTA27	CTA-403	2023/08/02	2024/08/01
Automated filter bank	Tonscend	JS0806-F	CTA-404	2023/08/02	2024/08/01
Power Sensor	Agilent	U2021XA	CTA-405	2023/08/02	2024/08/01
Amplifier	Schwarzbeck	BBV9719	CTA-406	2023/08/02	2024/08/01

Test Equipment	Manufacturer	Model No.	Version number	Calibration Date	Calibration Due Date
EMI Test Software	Tonscend	TS@JS32-RE	5.0.0.2	N/A	N/A
EMI Test Software	Tonscend	TS@JS32-CE	5.0.0.1	N/A	N/A
RF Test Software	Tonscend	TS@JS1120-3	3.1.65	N/A	N/A
RF Test Software	Tonscend	TS@JS1120	3.1.46	N/A	N/A

4 TEST CONDITIONS AND RESULTS

4.1 Output Power

TEST APPLICABLE

During the process of testing, the EUT was controlled via R&S Digital Radio Communication tester (CMW500) to ensure max power transmission and proper modulation. This result contains output power and EIRP measurements for the EUT. In all cases, output power is within the specified limits.

4.1.1 Conducted Output Power

TEST CONFIGURATION

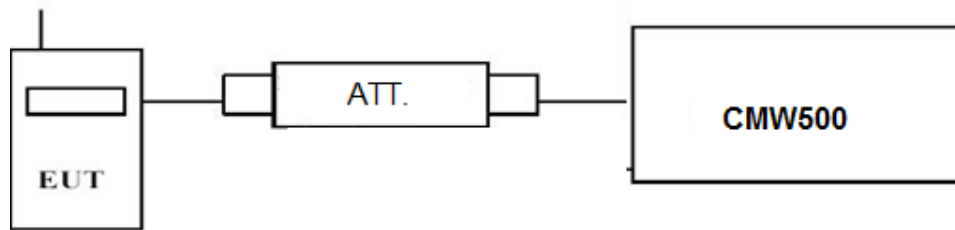

TEST PROCEDURE

Conducted Power Measurement:

- Place the EUT on a bench and set it in transmitting mode.
- Connect a low loss RF cable from the antenna port to a CMW500 by an Att.
- EUT Communicate with CMW500 then selects a channel for testing.
- Add a correction factor to the display CMW500, and then test.

GSM850				
Function	Power step	Nominal output power (dBm)	Power & Multislot class	Operation class
GSM	5	33dBm(2W)	4	/
GPRS	3	33dBm(2W)	12	B

PCS1900				
Function	Power step	Nominal output power (dBm)	Power & Multislot class	Operation class
GSM	0	30dBm(1W)	1	/
GPRS	3	30dBm(1W)	12	B

TEST RESULTS

GSM 850		Burst Average Conducted power (dBm)		
		Channel/Frequency(MHz)		
		128/824.2	190/836.6	251/848.8
GSM		32.31	32.35	32.62
GPRS (GMSK)	1TX slot	32.54	32.63	32.56
	2TX slot	29.48	29.58	28.82
	3TX slot	27.24	26.91	27.64
	4TX slot	26.68	25.75	26.77
GSM 1900		Burst Average Conducted power (dBm)		
		Channel/Frequency(MHz)		
		512/1850.2	661/1880.0	810/1909.8
GSM		30.65	29.87	29.82
GPRS (GMSK)	1TX slot	30.55	30.21	29.81
	2TX slot	27.24	27.27	26.75
	3TX slot	25.83	25.52	25.78
	4TX slot	24.31	23.99	23.87

4.1.2 Radiated Output Power

TEST DESCRIPTION

This is the test for the maximum radiated power from the EUT.

Rule Part 24.232(c) specifies, "Mobile/portable stations are limited to 2 watts e.i.r.p. Peak power" and 24.232(e) specifies that "Peak transmit power must be measured over any interval of continuous transmission using instrumentation calibrated in terms of an rms-equivalent voltage." Rule Part 22.913(a) specifies "The ERP of mobile transmitters and auxiliary test transmitters must not exceed 7 Watts."

TEST CONFIGURATION

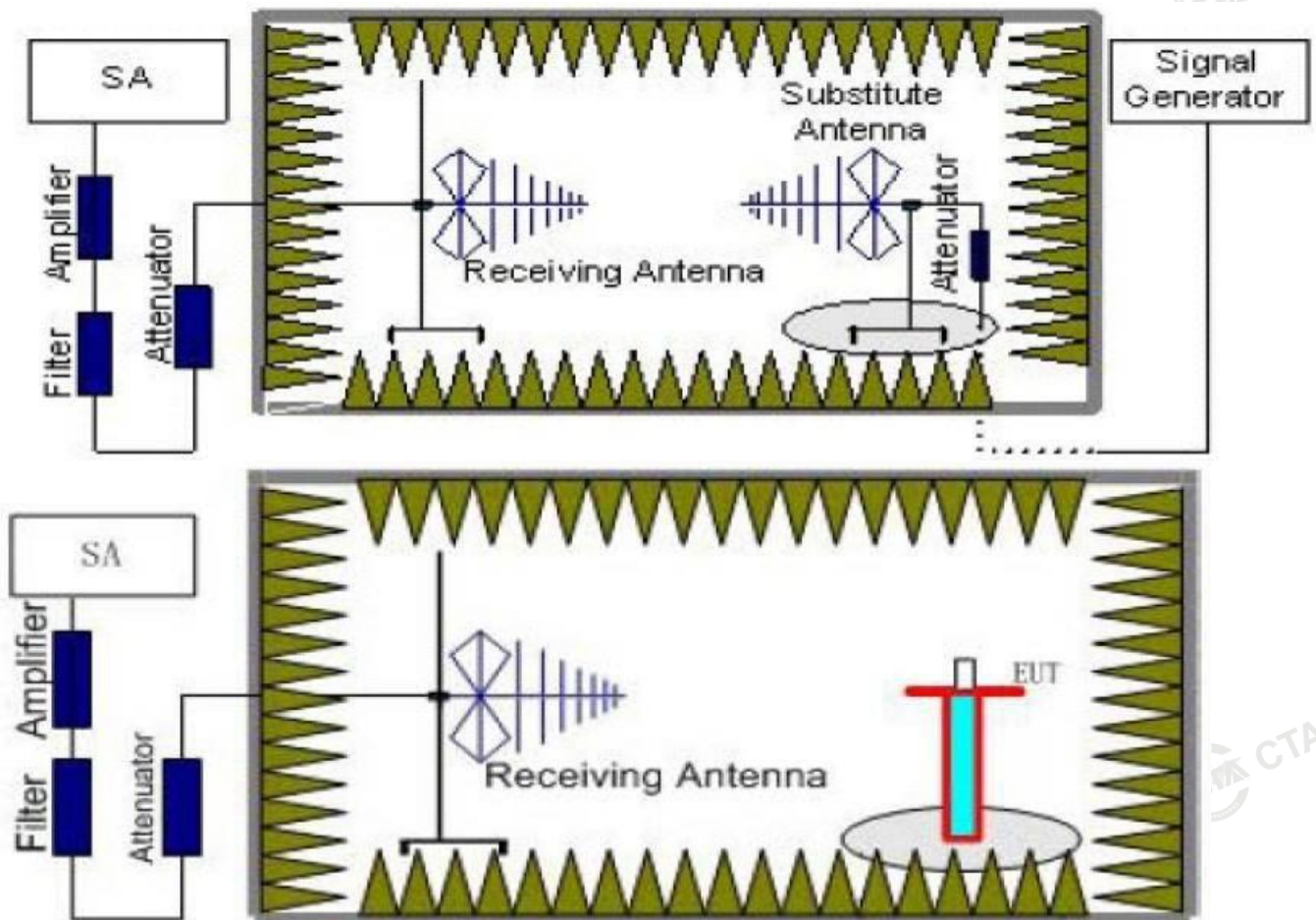

TEST PROCEDURE

1. EUT was placed on a 0.80 meter high non-conductive stand at a 3 meter test distance from the receive antenna. A receiving antenna was placed on the antenna mast 3 meters from the EUT for emission measurements. The height of receiving antenna is 0.80m. Detected emissions were maximized at each frequency by rotating the EUT through 360° and adjusting the receiving antenna polarization. The radiated emission measurements of all transmit frequencies in three channels (High, Middle, Low) were measured with peak detector.
2. A log-periodic antenna or double-ridged waveguide horn antenna shall be substituted in place of the EUT. The log-periodic antenna will be driven by a signal generator and the level will be adjusted till the same power value on the spectrum analyzer or receiver. The level of the spurious emissions can be calculated through the level of the signal generator, cable loss, the gain of the substitution antenna and the reading of the spectrum analyzer or receiver.
3. The EUT is then put into continuously transmitting mode at its maximum power level during the test. Set Test Receiver or Spectrum RBW=1MHz, VBW=3MHz, And the maximum value of the receiver should be recorded as (P_r).
4. The EUT shall be replaced by a substitution antenna. In the chamber, an substitution antenna for the frequency band of interest is placed at the reference point of the chamber. An RF Signal source for the frequency band of interest is connected to the substitution antenna with a cable that has been constructed to not interfere with the radiation pattern of the antenna. A power (P_{Mea}) is applied to the input of the

substitution antenna, and adjust the level of the signal generator output until the value of the receiver reach the previously recorded (P_r). The power of signal source (P_{Mea}) is recorded. The test should be performed by rotating the test item and adjusting the receiving antenna polarization.

- A amplifier should be connected to the Signal Source output port. And the cable should be connect between the Amplifier and the Substitution Antenna. The cable loss (P_{cl}), the Substitution Antenna Gain (G_a) and the Amplifier Gain (P_{Ag}) should be recorded after test.

The measurement results are obtained as described below:

$$\text{Power(EIRP)} = P_{Mea} - P_{Ag} - P_{cl} + G_a$$

We used SMF100A micowave signal generator which signal level can up to 33dBm,so we not used power Amplifier for substitution test; The measurement results are amend as described below:

$$\text{Power(EIRP)} = P_{Mea} - P_{cl} + G_a$$

- This value is EIRP since the measurement is calibrated using an antenna of known gain (2.15 dBi) and known input power.
- ERP can be calculated from EIRP by subtracting the gain of the dipole, $ERP = EIRP - 2.15\text{dBi}$.

TEST LIMIT

Note: We test the H direction and V direction, V direction is worse.

According to 22.913(a) and 24.232(c), the ERP should be not exceed following table limits:

GSM850(GPRS850,EDGE850)		
Function	Power Step	Burst Peak ERP (dBm)
GSM	5	≤38.45dBm (7W)
GPRS	3	≤38.45dBm (7W)

PCS1900(GPRS1900,EDGE1900)		
Function	Power Step	Burst Peak EIRP (dBm)
GSM	0	≤33dBm (2W)
GPRS	3	≤33dBm (2W)

TEST RESULTS

Remark:

- We were tested all Configuration refer 3GPP TS151 010.
- $EIRP = P_{Mea}(\text{dBm}) - P_{cl}(\text{dB}) + P_{Ag}(\text{dB}) + G_a(\text{dBi})$
- $ERP = EIRP - 2.15\text{dBi}$ as EIRP by subtracting the gain of the dipole.

Note: We tesed Horizontal and Vertical, and Recorded the worst data at the Vertical

GSM 850

Frequency (MHz)	P_{Mea} (dBm)	P_{cl} (dB)	G_a Antenna Gain(dB)	Correction (dB)	P_{Ag} (dB)	ERP (dBm)	Limit (dBm)	Margin (dB)	Polarization
824.20	-6.25	2.42	8.45	2.15	36.82	34.45	38.45	-4.00	V
836.60	-6.74	2.46	8.45	2.15	36.82	33.92	38.45	-4.53	V
848.80	-6.08	2.53	8.36	2.15	36.82	34.42	38.45	-4.03	V

GSM 1900

Frequency (MHz)	P_{Mea} (dBm)	P_{cl} (dB)	G_a Antenna Gain(dB)	P_{Ag} (dB)	EIRP (dBm)	Limit (dBm)	Margin (dB)	Polarization
1850.20	-12.36	3.41	10.24	33.60	28.07	33.01	-4.94	V
1880.00	-12.51	3.49	10.24	33.60	27.84	33.01	-5.17	V
1909.80	-12.48	3.55	10.23	33.60	27.80	33.01	-5.21	V

GPRS 850

Frequency (MHz)	P _{Mea} (dBm)	P _{cl} (dB)	G _a Antenna Gain(dB)	Correction (dB)	P _{Ag} (dB)	ERP (dBm)	Limit (dBm)	Margin (dB)	Polarization
824.20	-8.91	2.42	8.45	2.15	36.82	31.79	38.45	-6.66	V
836.60	-7.36	2.46	8.45	2.15	36.82	33.30	38.45	-5.15	V
848.80	-7.45	2.53	8.36	2.15	36.82	33.05	38.45	-5.40	V

GPRS 1900

Frequency (MHz)	P _{Mea} (dBm)	P _{cl} (dB)	G _a Antenna Gain(dB)	P _{Ag} (dB)	EIRP (dBm)	Limit (dBm)	Margin (dB)	Polarization
1850.20	-12.73	3.41	10.24	33.60	27.70	33.01	-5.31	V
1880.00	-12.01	3.49	10.24	33.60	28.34	33.01	-4.67	V
1909.80	-12.44	3.55	10.23	33.60	27.84	33.01	-5.17	V

4.2 Radiated Spurious Emission

TEST APPLICABLE

According to the TIA/EIA 603D:2010 test method, The Receiver or Spectrum was scanned from 30 MHz to the 10th harmonic of the highest frequency generated within the equipment, which is the transmitted carrier that can be as high as 1910 MHz. The resolution bandwidth is set as outlined in Part 24.238 and Part 22.917. The spectrum is scanned with the mobile station transmitting at carrier frequencies that pertain to low, mid and high channels of PCS1900 and GSM850.

TEST CONFIGURATION

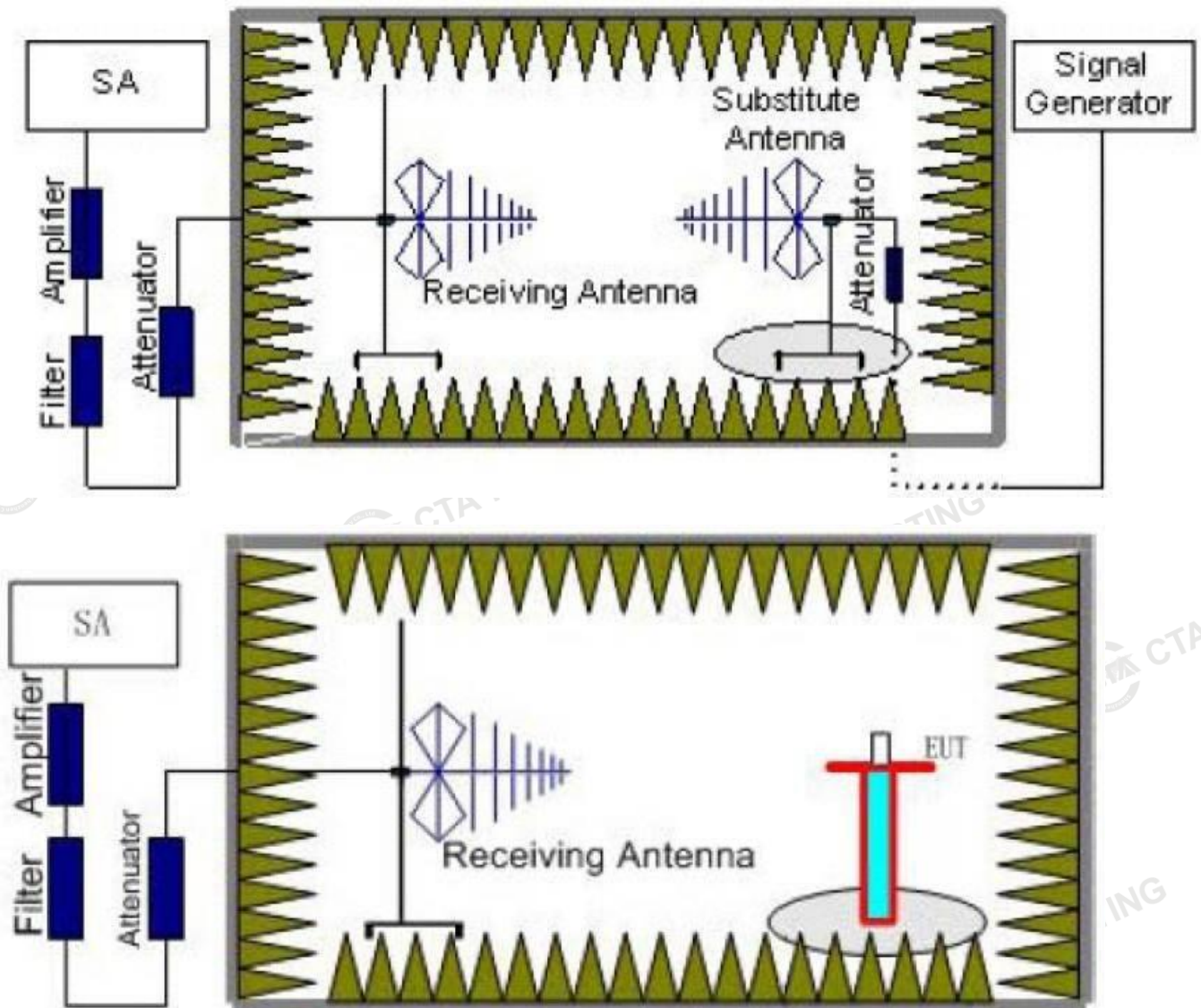

TEST PROCEDURE

1. EUT was placed on a 0.80 meter high non-conductive stand at a 3 meter test distance from the receive antenna. A receiving antenna was placed on the antenna mast 3 meters from the EUT for emission measurements. The height of receiving antenna is 0.80m. Detected emissions were maximized at each frequency by rotating the EUT through 360° and adjusting the receiving antenna polarization. The radiated emission measurements of all transmit frequencies in three channels (High, Middle, Low) were measured with peak detector.
2. A log-periodic antenna or double-ridged waveguide horn antenna shall be substituted in place of the EUT. The log-periodic antenna will be driven by a signal generator and the level will be adjusted till the same power value on the spectrum analyzer or receiver. The level of the spurious emissions can be calculated

through the level of the signal generator, cable loss, the gain of the substitution antenna and the reading of the spectrum analyzer or receiver.

3. The EUT is then put into continuously transmitting mode at its maximum power level during the test. Set Test Receiver or Spectrum RBW=1MHz,VBW=3MHz, And the maximum value of the receiver should be recorded as (P_r).
4. The EUT shall be replaced by a substitution antenna. In the chamber, an substitution antenna for the frequency band of interest is placed at the reference point of the chamber. An RF Signal source for the frequency band of interest is connected to the substitution antenna with a cable that has been constructed to not interfere with the radiation pattern of the antenna. A power (P_{Mea}) is applied to the input of the substitution antenna, and adjust the level of the signal generator output until the value of the receiver reach the previously recorded (P_r). The power of signal source (P_{Mea}) is recorded. The test should be performed by rotating the test item and adjusting the receiving antenna polarization.
5. A amplifier should be connected to the Signal Source output port. And the cable should be connect between the Amplifier and the Substitution Antenna. The cable loss (P_{cl}), the Substitution Antenna Gain (G_a) and the Amplifier Gain (P_{Ag}) should be recorded after test.
The measurement results are obtained as described below:
Power(EIRP)=P_{Mea}- P_{Ag} - P_{cl} + G_a
6. This value is EIRP since the measurement is calibrated using an antenna of known gain (2.15 dBi) and known input power.
7. ERP can be calculated from EIRP by subtracting the gain of the dipole, ERP = EIRP -2.15dBi.
8. In order to make sure test results more clearly,we set frequency range and sweep time for difference frequency range as follows table:

Working Frequency	Subrange (GHz)	RBW	VBW	Sweep time (s)
GSM 850	0.00009~0.15	1KHz	3KHz	30
	0.00015~0.03	10KHz	30KHz	10
	0.03~1	100KHz	300KHz	10
	1~2	1 MHz	3 MHz	2
	2~5	1 MHz	3 MHz	3
	5~8	1 MHz	3 MHz	3
	8~10	1 MHz	3 MHz	3
PCS 1900	0.00009~0.15	1KHz	3KHz	30
	0.00015~0.03	10KHz	30KHz	10
	0.03~1	100KHz	300KHz	10
	1~2	1 MHz	3 MHz	2
	2~5	1 MHz	3 MHz	3
	5~8	1 MHz	3 MHz	3
	8~11	1 MHz	3 MHz	3
	11~14	1 MHz	3 MHz	3
	14~18	1 MHz	3 MHz	3
18~20	1 MHz	3 MHz	2	

TEST LIMITS

According to 24.238 and 22.917 specify that the power of any emission outside of the authorized operating frequency ranges must be attenuated below the transmitting power (P) by a factor of at least 43 + 10 log(P) dB.

The specification that emissions shall be attenuated below the transmitter power (P) by at least 43 + 10 log (P) dB, translates in the relevant power range (1 to 0.001 W) to -13 dBm. At 1 W the specified minimum attenuation becomes 43 dB and relative to a 30 dBm (1 W) carrier becomes a limit of -13 dBm. At 0.001 W (0 dBm) the minimum attenuation is 13 dB, which again yields a limit of -13 dBm. In this way a translation of the specification from relative to absolute terms is carried out.

Frequency	Channel	Frequency Range	Verdict
GSM 850	Low	9KHz-10GHz	PASS
	Middle	9KHz -10GHz	PASS
	High	9KHz -10GHz	PASS
PCS 1900	Low	9KHz -20GHz	PASS
	Middle	9KHz -20GHz	PASS
	High	9KHz -20GHz	PASS

TEST RESULTS

Remark:

1. We were tested all refer 3GPP TS151 010.
2. $EIRP = P_{Mea}(dBm) - P_{cl}(dB) + G_a(dBi)$
3. We were not recorded other points as values lower than limits.
4. Margin = Limit - EIRP

Note : We tested GSM and GPRS Mode, and recorded the worst case at the GSM Mode

GSM850_ Low Channel

Frequency (MHz)	P _{Mea} (dBm)	P _{cl} (dB)	Diatance	G _a Antenna Gain(dB)	EIRP (dBm)	Limit (dBm)	Margin (dB)	Polarization
1648.4	-45.43	3.00	3.00	9.58	-38.85	-13.00	25.85	H
2472.6	-51.90	3.03	3.00	10.72	-44.21	-13.00	31.21	H
1648.4	-44.13	3.00	3.00	9.68	-37.45	-13.00	24.45	V
2472.6	-45.95	3.03	3.00	10.72	-38.26	-13.00	25.26	V

GSM850_ Middle Channel

Frequency (MHz)	P _{Mea} (dBm)	P _{cl} (dB)	Diatance	G _a Antenna Gain(dB)	EIRP (dBm)	Limit (dBm)	Margin (dB)	Polarization
1673.2	-43.28	3.00	3.00	9.58	-36.70	-13.00	23.70	H
2509.8	-51.92	3.03	3.00	10.72	-44.23	-13.00	31.23	H
1673.2	-40.77	3.00	3.00	9.68	-34.09	-13.00	21.09	V
2509.8	-50.62	3.03	3.00	10.72	-42.93	-13.00	29.93	V

GSM850_ High Channel

Frequency (MHz)	P _{Mea} (dBm)	P _{cl} (dB)	Diatance	G _a Antenna Gain(dB)	EIRP (dBm)	Limit (dBm)	Margin (dB)	Polarization
1697.6	-42.88	3.00	3.00	9.58	-36.30	-13.00	23.30	H
2546.4	-54.72	3.03	3.00	10.72	-47.03	-13.00	34.03	H
1697.6	-42.79	3.00	3.00	9.68	-36.11	-13.00	23.11	V
2546.4	-47.66	3.03	3.00	10.72	-39.97	-13.00	26.97	V

GSM1900_ Low Channel

Frequency (MHz)	P _{Mea} (dBm)	P _{cl} (dB)	Diatance	G _a Antenna Gain(dB)	Peak EIRP (dBm)	Limit (dBm)	Margin (dB)	Polarization
3700.4	-44.54	4.39	3.00	12.34	-36.59	-13.00	23.59	H
5550.6	-46.65	5.31	3.00	13.52	-38.44	-13.00	25.44	H
3700.4	-43.61	4.39	3.00	12.34	-35.66	-13.00	22.66	V
5550.6	-53.54	5.31	3.00	13.52	-45.33	-13.00	32.33	V

GSM1900_ Middle Channel

Frequency (MHz)	P _{Mea} (dBm)	P _{cl} (dB)	Diatance	G _a Antenna Gain(dB)	EIRP (dBm)	Limit (dBm)	Margin (dB)	Polarization
3760.0	-40.96	4.41	3.00	12.34	-33.03	-13.00	20.03	H
5640.0	-48.65	5.38	3.00	13.58	-40.45	-13.00	27.45	H
3760.0	-43.49	4.41	3.00	12.34	-35.56	-13.00	22.56	V
5640.0	-46.57	5.38	3.00	13.58	-38.37	-13.00	25.37	V

GSM1900_ High Channel

Frequency (MHz)	P _{Mea} (dBm)	P _{cl} (dB)	Diatance	G _a Antenna Gain(dB)	EIRP (dBm)	Limit (dBm)	Margin (dB)	Polarization
3819.6	-42.31	4.45	3.00	12.45	-34.31	-13.00	21.31	H
5729.4	-54.03	5.47	3.00	13.66	-45.84	-13.00	32.84	H
3819.6	-41.31	4.45	3.00	12.45	-33.31	-13.00	20.31	V
5729.4	-49.77	5.48	3.00	13.66	-41.59	-13.00	28.59	V

4.3 Occupied Bandwidth and Emission Bandwidth

TEST APPLICABLE

Similar to conducted emissions; occupied bandwidth measurements are only provided for selected frequencies in order to reduce the amount of submitted data. Data were taken at the extreme and mid frequencies of PCS1900 band and GSM850 band. The table below lists the measured 99% Bandwidth and -26dBc Bandwidth.

TEST CONFIGURATION

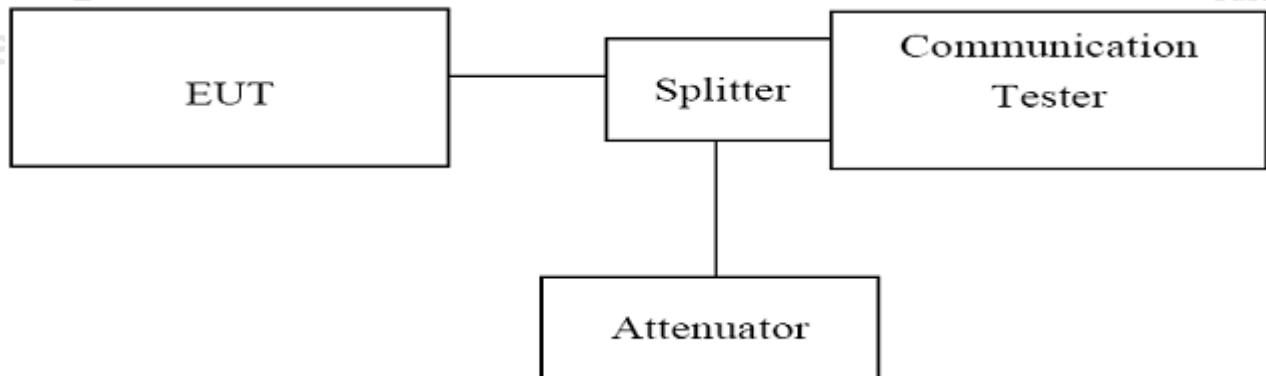

TEST PROCEDURE

1. The EUT was set up for the max output power with pseudo random data modulation;
2. The Occupied bandwidth and Emission Bandwidth were measured with Agilent Spectrum Analyzer N9030A (peak);
3. Set RBW=5.1KHz, VBW=51KHz, Span=1MHz, SWT=500ms;
4. Set SPA Max hold and View, Set 99% Occupied Bandwidth/ Set -26dBc Occupied Bandwidth
5. These measurements were done at 3 frequencies, 1850.20 MHz, 1880.00 MHz and 1909.80 MHz for PCS1900 band; 824.20MHz, 836.60 MHz and 848.80 MHz for GSM850 band. (Low, middle and high of operational frequency range).

TEST RESULTS

GSM 850				
Channel Number	Frequency (MHz)	Occupied Bandwidth (99% BW) (MHz)	Emission Bandwidth (26 dBc BW) (MHz)	Verdict
128	824.20	0.24758	0.3120	PASS
190	836.60	0.24348	0.3042	PASS
251	848.80	0.24578	0.3131	PASS

GSM 1900				
Channel Number	Frequency (MHz)	Occupied Bandwidth (99% BW) (MHz)	Emission Bandwidth (26 dBc BW) (MHz)	Verdict
512	1850.20	0.24610	0.3124	PASS
661	1880.00	0.24621	0.3153	PASS
810	1909.80	0.24788	0.3135	PASS

GPRS 850				
Channel Number	Frequency (MHz)	Occupied Bandwidth (99% BW) (MHz)	Emission Bandwidth (26 dBc BW) (MHz)	Verdict
128	824.20	0.24444	0.3159	PASS
190	836.60	0.24521	0.3097	PASS
251	848.80	0.24471	0.3079	PASS

GPRS 1900				
Channel Number	Frequency (MHz)	Occupied Bandwidth (99% BW) (MHz)	Emission Bandwidth (26 dBc BW) (MHz)	Verdict
512	1850.20	0.24834	0.3130	PASS
661	1880.00	0.24725	0.3118	PASS
810	1909.80	0.24698	0.3125	PASS

GSM 850

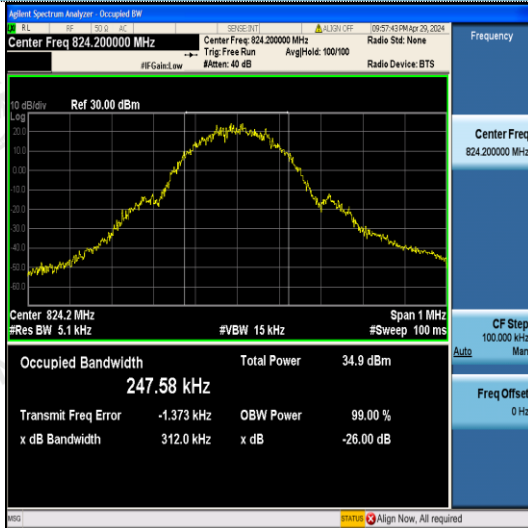

GSM 1900

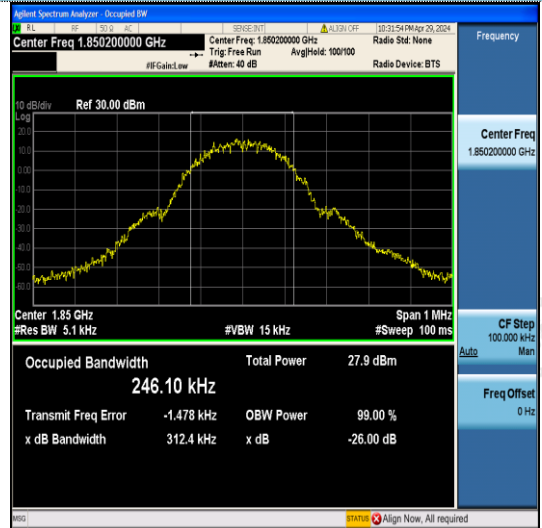

Channel 128

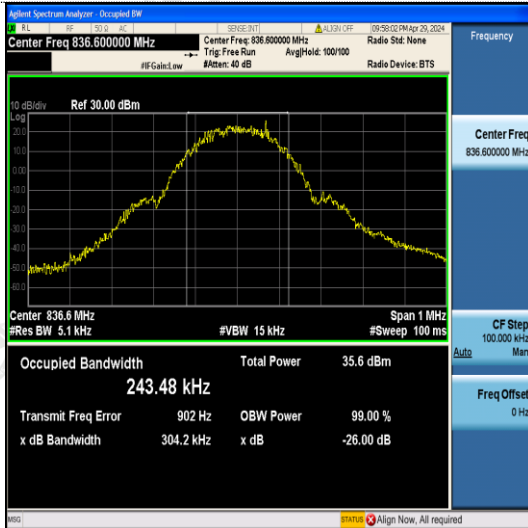

Channel 512

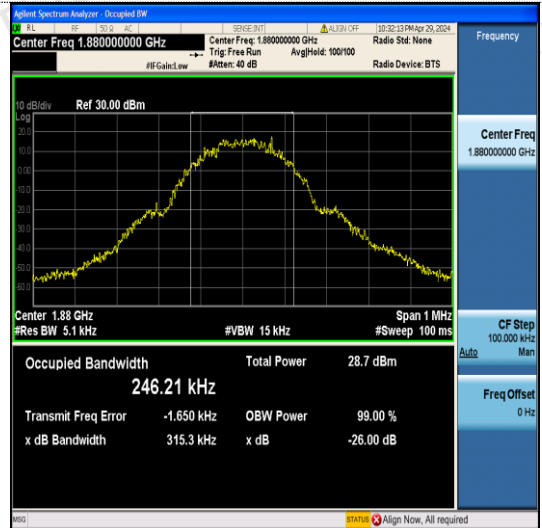

Channel 190

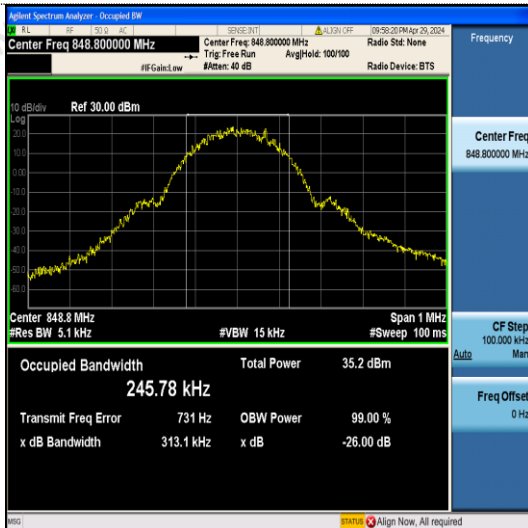

Channel 661

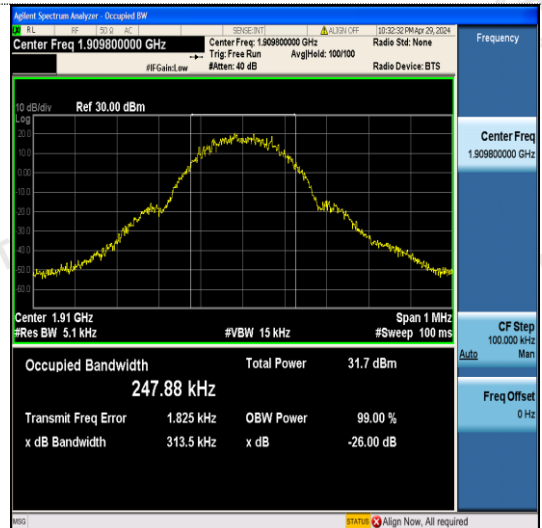

Channel 251

Channel 810

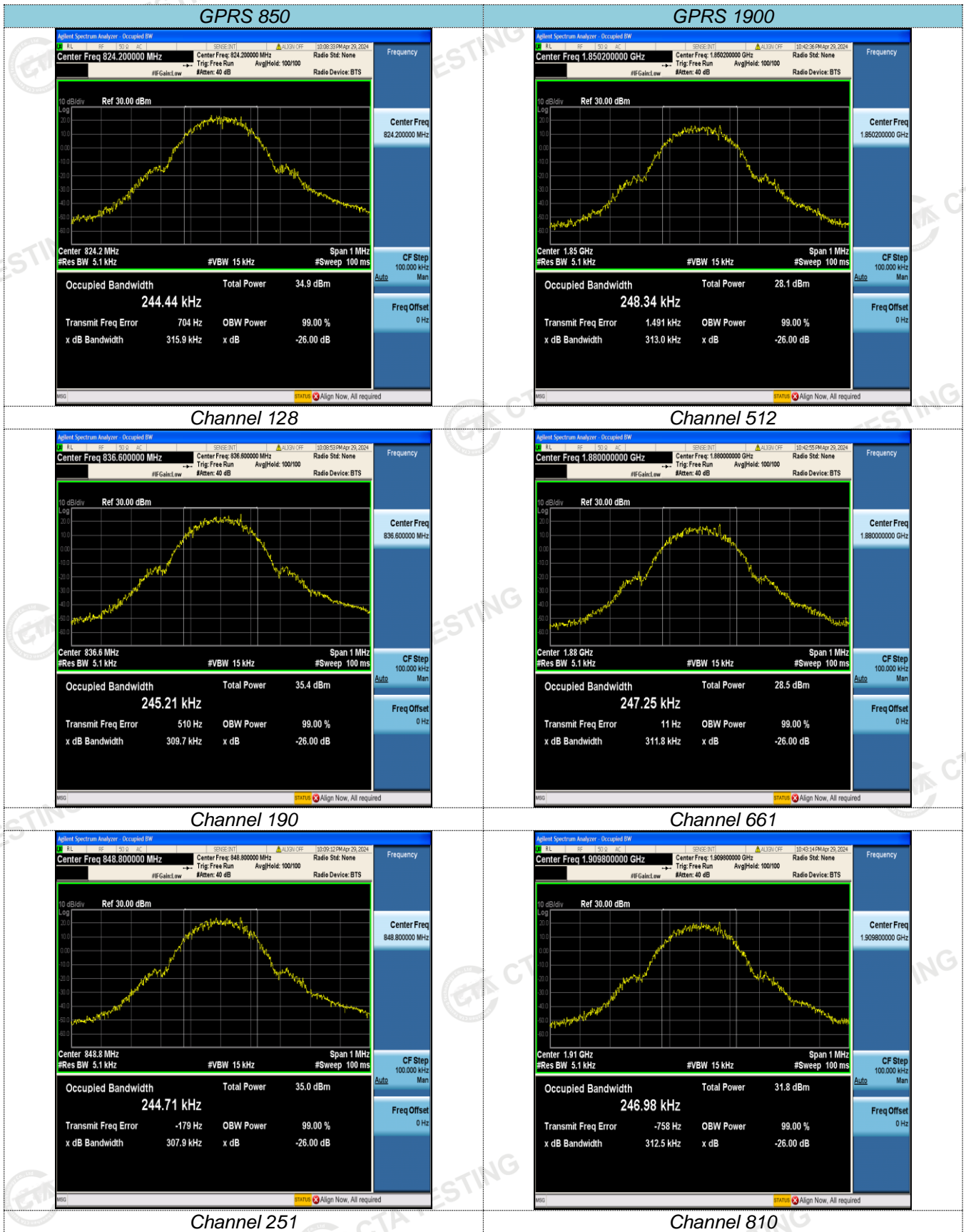

4.4 Band Edge Compliance

TEST APPLICABLE

During the process of testing, the EUT was controlled via Agilent Digital Radio Communication tester (CMW500) to ensure max power transmission and proper modulation.

TEST CONFIGURATION

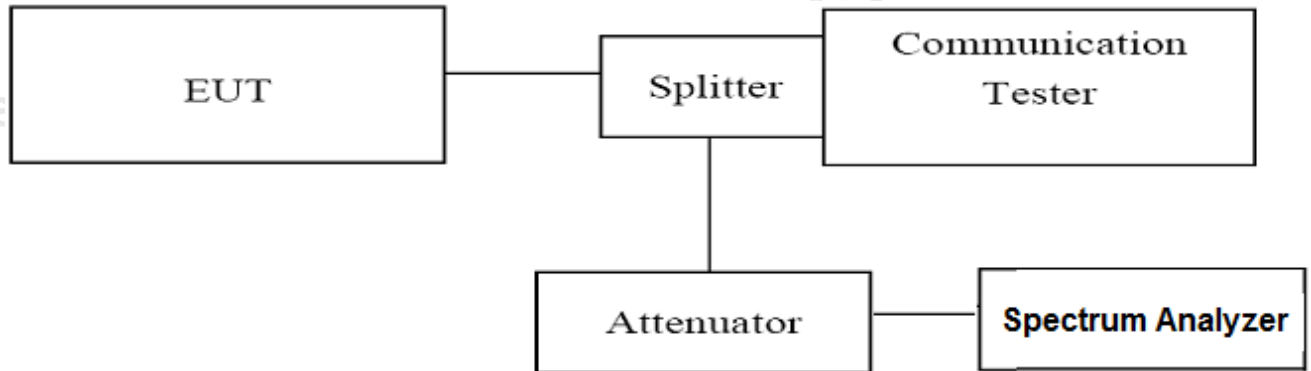

TEST PROCEDURE

1. The EUT was set up for the max output power with pseudo random data modulation;
2. The power was measured with Agilent Spectrum Analyzer N9030A;
3. Set RBW=5.1KHz, VBW=51KHz, Span=3MHz, SWT=300ms, Dector: RMS;
4. These measurements were done at 3 frequencies, 1850.20 MHz, 1880.00 MHz and 1909.80 MHz for PCS1900 band; 824.20 MHz, 836.60 MHz and 848.80 MHz for GSM850 band. (bottom, middle and top of operational frequency range).

TEST RESULTS

GSM 850					
Channel Number	Frequency (MHz)	Measurement Results		Limit (dBm)	Verdict
		Frequency (MHz)	Values (dBm)		
128	824.20	823.98	-14.43	-13.00	PASS
251	848.80	849.02	-14.16	-13.00	PASS

GSM 1900					
Channel Number	Frequency (MHz)	Measurement Results		Limit (dBm)	Verdict
		Frequency (MHz)	Values (dBm)		
512	1850.20	1849.98	-21.60	-13.00	PASS
810	1909.80	1910.02	-16.52	-13.00	PASS

GPRS 850					
Channel Number	Frequency (MHz)	Measurement Results		Limit (dBm)	Verdict
		Frequency (MHz)	Values (dBm)		
128	824.20	823.99	-14.86	-13.00	PASS
251	848.80	849.02	-13.67	-13.00	PASS

GPRS 1900					
Channel Number	Frequency (MHz)	Measurement Results		Limit (dBm)	Verdict
		Frequency (MHz)	Values (dBm)		
512	1850.20	1850.00	-19.79	-13.00	PASS
810	1909.80	1910.01	-17.45	-13.00	PASS

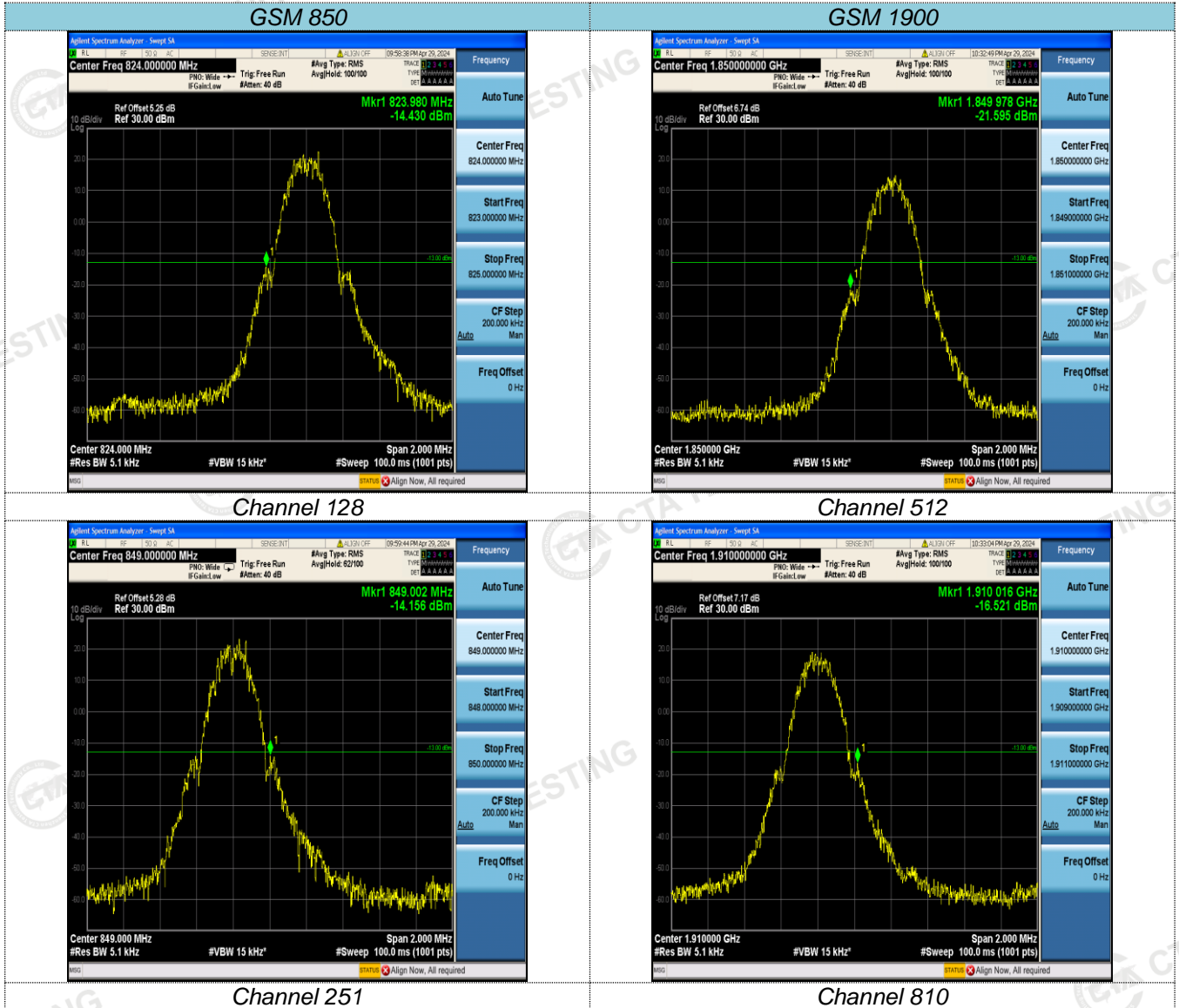

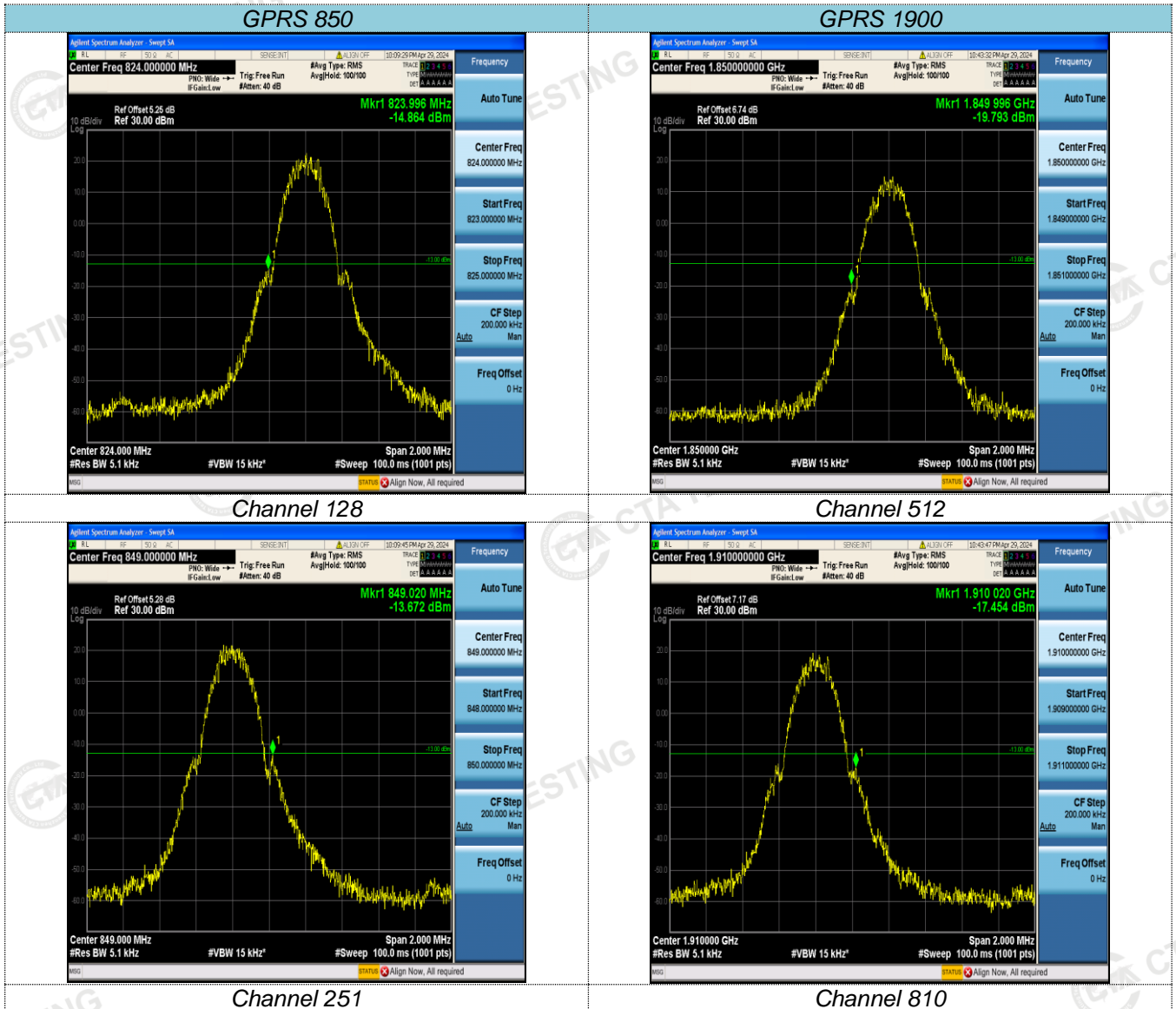

4.5 Spurious Emission on Antenna Port

TEST APPLICABLE

The following steps outline the procedure used to measure the conducted emissions from the EUT.

1. Determine frequency range for measurements: From CFR 2.1057 the spectrum should be investigated from the lowest radio frequency generated in the equipment up to at least the 10th harmonic of the carrier frequency. For the equipment of PCS1900 band, this equates to a frequency range of 9 KHz to 19.1 GHz, data taken from 9 KHz to 25 GHz. For GSM850, data taken from 9 KHz to 9 GHz.
2. The sweep time is set automatically by instrument itself. That should be the optimal sweep time for the span and the RBW. If the sweep time is too short, that is sweep is too fast, the sweep result is not accurate; if the sweep time is too long, that is sweep is too low, some frequency components may be lost. The instrument will give an optimal sweep time according the selected span and RBW.
3. The procedure to get the conducted spurious emission is as follows:
The trace mode is set to MaxHold to get the highest signal at each frequency;
Wait 25 seconds;
Get the result.
4. Determine EUT transmit frequencies: below outlines the band edge frequencies pertinent to conducted emissions testing.

TEST CONFIGURATION

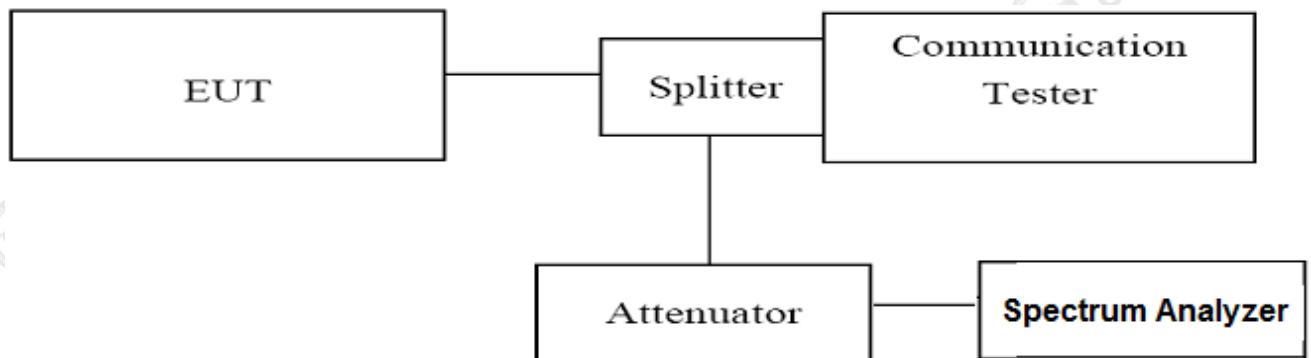

TEST PROCEDURE

1. The EUT was set up for the max output power with pseudo random data modulation;
2. The power was measured with Agilent Spectrum Analyzer N9030A (peak);
3. These measurements were done at 3 frequencies, 1850.20 MHz, 1880.00 MHz and 1909.80 MHz for PCS1900 band; 824.20 MHz, 836.60 MHz and 848.80 MHz for GSM850 band. (Low, middle and high of operational frequency range).

TEST LIMIT

Part 24.238 and Part 22.917 specify that the power of any emission outside of the authorized operating frequency ranges must be attenuated below the transmitting power (P) by a factor of at least $43 + 10 \log(P)$ dB.

The specification that emissions shall be attenuated below the transmitter power (P) by at least $43 + 10 \log(P)$ dB, translates in the relevant power range (1 to 0.001 W) to -13 dBm. At 1 W the specified minimum attenuation becomes 43 dB and relative to a 30 dBm (1 W) carrier becomes a limit of -13 dBm. At 0.001 W (0 dBm) the minimum attenuation is 13 dB, which again yields a limit of -13 dBm. In this way a translation of the specification from relative to absolute terms is carried out.

TEST RESULTS

Note: We tested GSM and GPRS mode and recorded the worst case at the GSM mode.

4.5.1 For GSM 850 Test Results

A. Test Verdict

Band	Channel	PCL	Frequency Range(MHz)	Max.Freq. (MHz)	Result (dBm)	Limit (dBm)	Verdict
GSM850	128	5	0.009~0.15MHz	0.01	-52.56	-33	PASS
GSM850	128	5	0.15~30MHz	0.15	-48.45	-23	PASS
GSM850	128	5	30~1000MHz	515.13	-49.30	-13	PASS
GSM850	128	5	1000~10000MHz	1649.2	-44.45	-13	PASS
GSM850	190	5	0.009~0.15MHz	0.01	-51.05	-33	PASS
GSM850	190	5	0.15~30MHz	0.15	-47.25	-23	PASS
GSM850	190	5	30~1000MHz	937.31	-49.51	-13	PASS
GSM850	190	5	1000~10000MHz	2509.9	-36.41	-13	PASS
GSM850	251	5	0.009~0.15MHz	0.01	-49.40	-33	PASS
GSM850	251	5	0.15~30MHz	0.16	-48.04	-23	PASS
GSM850	251	5	30~1000MHz	957.29	-49.71	-13	PASS
GSM850	251	5	1000~10000MHz	2546.5	-39.03	-13	PASS

Note:

1. In general, the worse case attenuation requirement shown above was applied.
2. "----" means that the emission level is too low to be measured or at least 20 dB down than the limit.

B. Test Plots

Test Mode:

GSM850

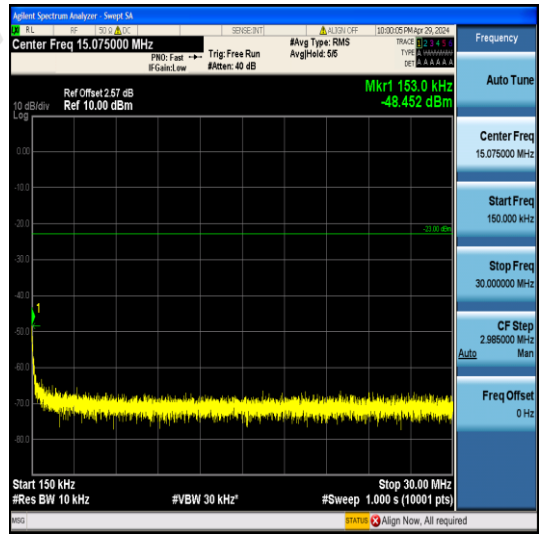
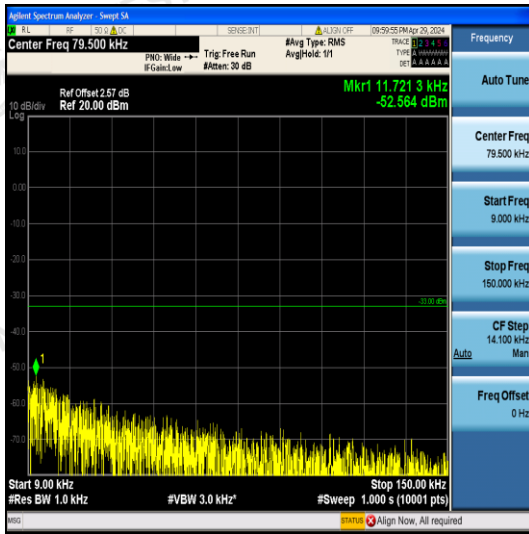

9KHz-150KHz

150KHz-30MHz

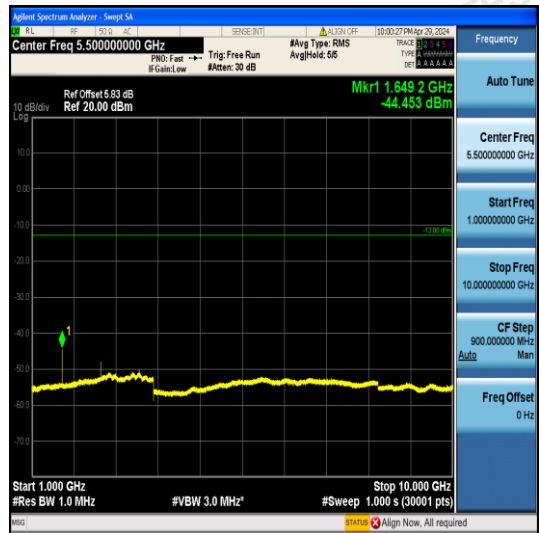
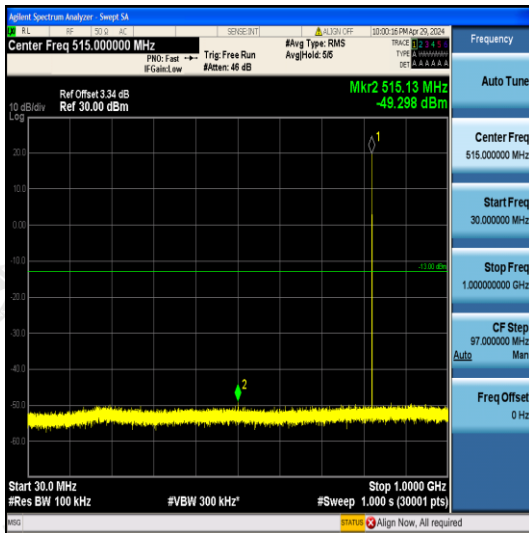

30MHz~1GHz

1GHz ~10GHz

Channel 128

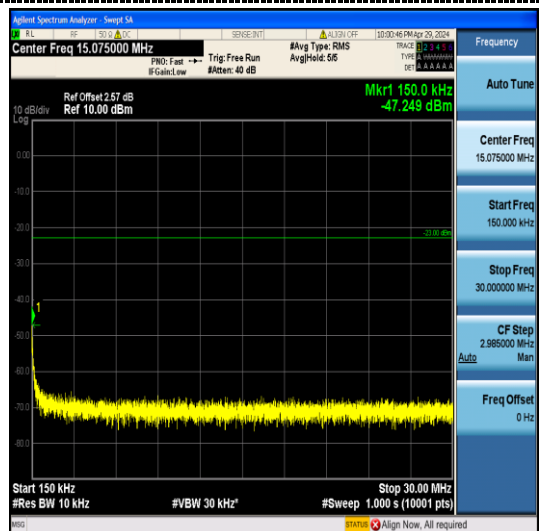
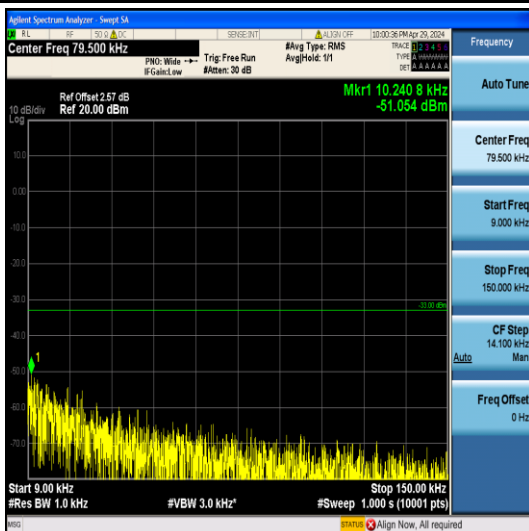

9KHz-150KHz

150KHz-30MHz

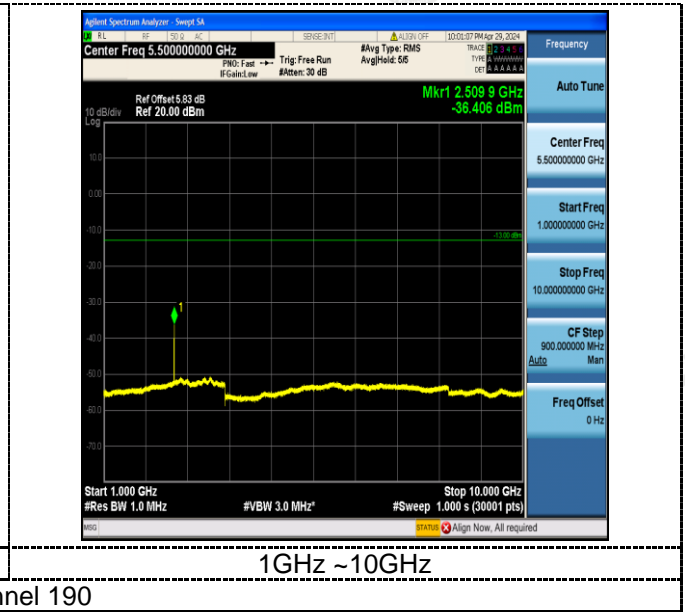
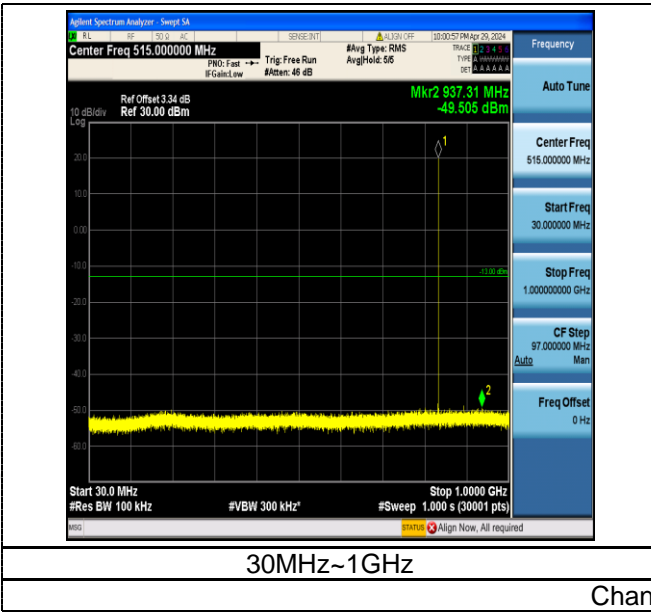

Channel 190

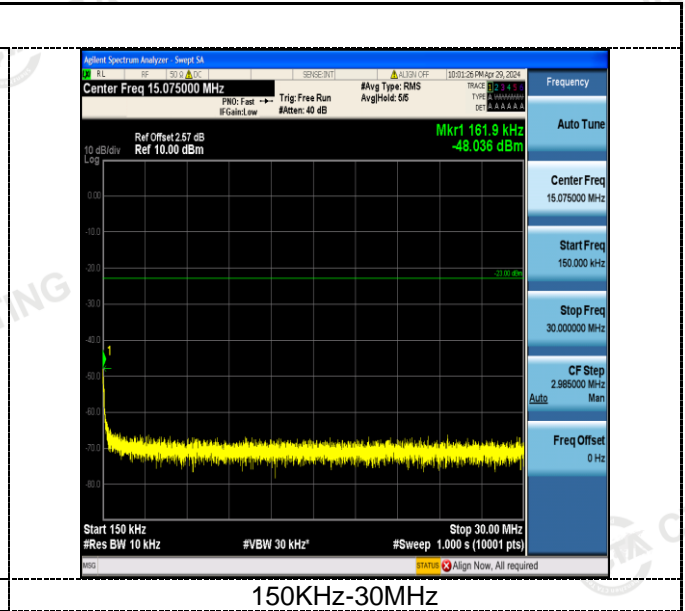
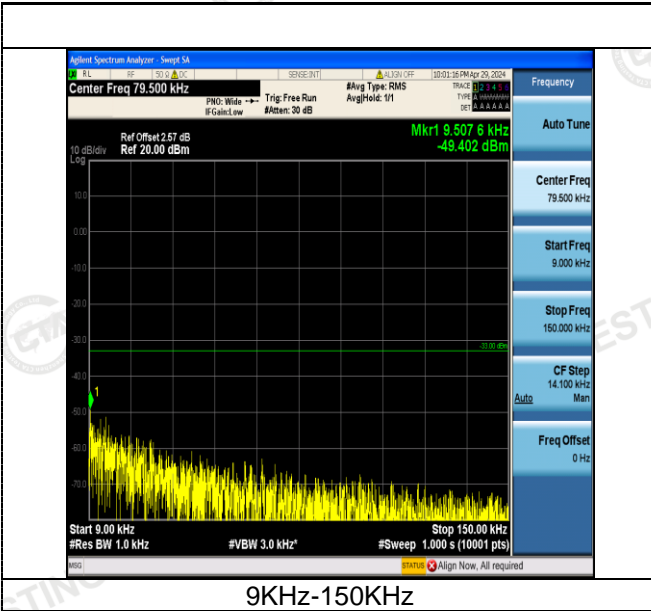

9KHz-150KHz

150KHz-30MHz

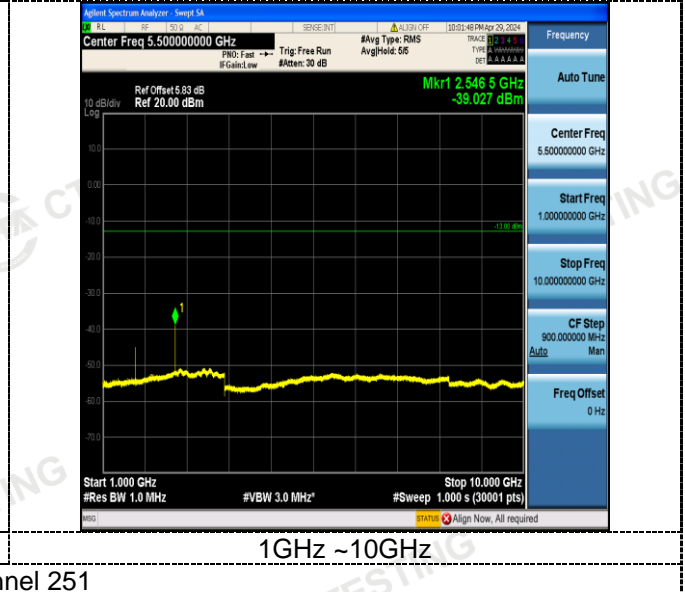
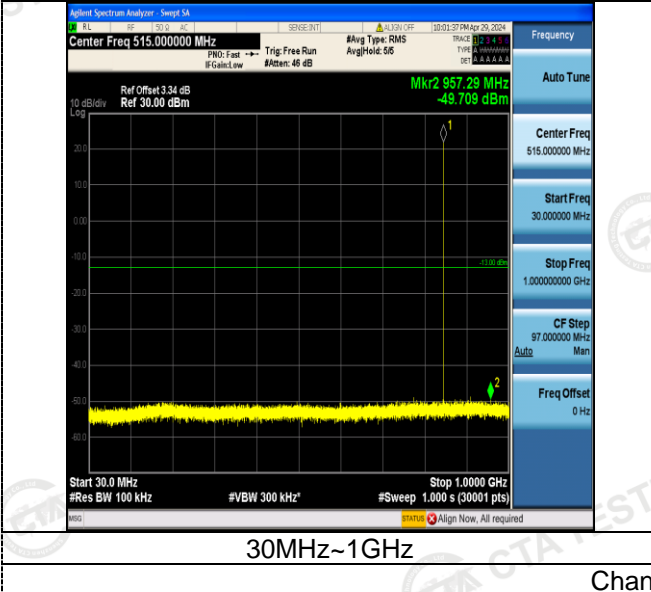

30MHz~1GHz

1GHz ~10GHz

Channel 251

4.5.2 For GSM 1900 Test Results

A. Test Verdict

Band	Channel	PCL	Frequency Range(MHz)	Max.Freq. (MHz)	Result (dBm)	Limit (dBm)	Verdict
GSM1900	512	0	0.009~0.15MHz	0.01	-53.57	-43	PASS
GSM1900	512	0	0.15~30MHz	0.15	-48.32	-33	PASS
GSM1900	512	0	30~1000MHz	206.77	-47.40	-13	PASS
GSM1900	512	0	1000~3000MHz	2647.87	-36.14	-13	PASS
GSM1900	661	0	3000~18000MHz	0.01	-53.39	-13	PASS
GSM1900	661	0	0.009~0.15MHz	0.15	-48.42	-43	PASS
GSM1900	661	0	0.15~30MHz	940.6	-47.29	-33	PASS
GSM1900	661	0	30~1000MHz	2665.73	-36.06	-13	PASS
GSM1900	810	0	1000~3000MHz	16918.5	-44.05	-13	PASS
GSM1900	810	0	3000~18000MHz	0.01	-53.58	-13	PASS
GSM1900	810	0	0.009~0.15MHz	0.15	-47.91	-43	PASS
GSM1900	810	0	0.15~30MHz	900.67	-47.15	-33	PASS

Note:

1. In general, the worse case attenuation requirement shown above was applied.
- 2."---" means that the emission level is too low to be measured or at least 20 dB down than the limit.

B. Test Plots

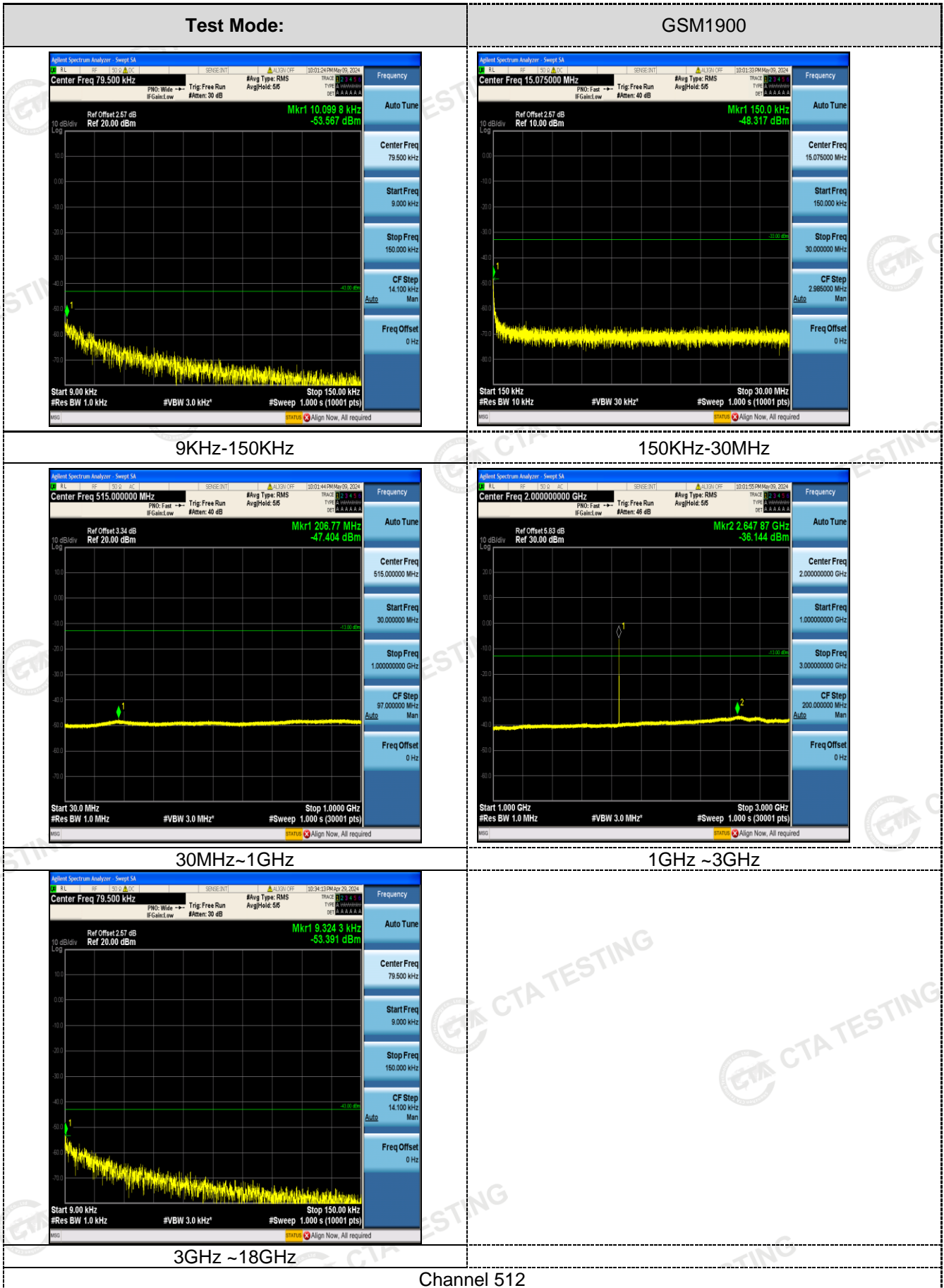

Channel 512

Test Mode:

GSM1900

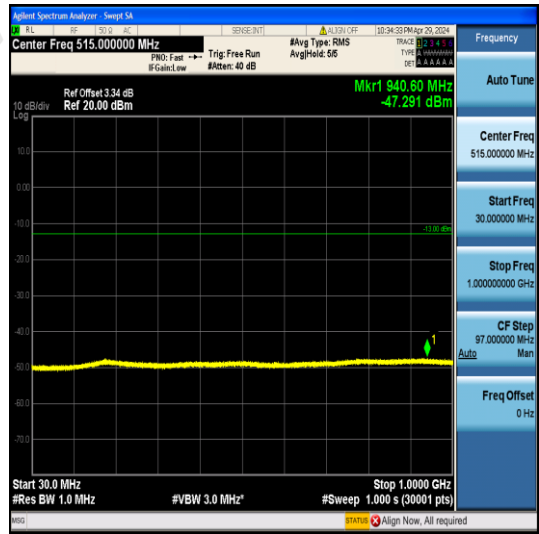
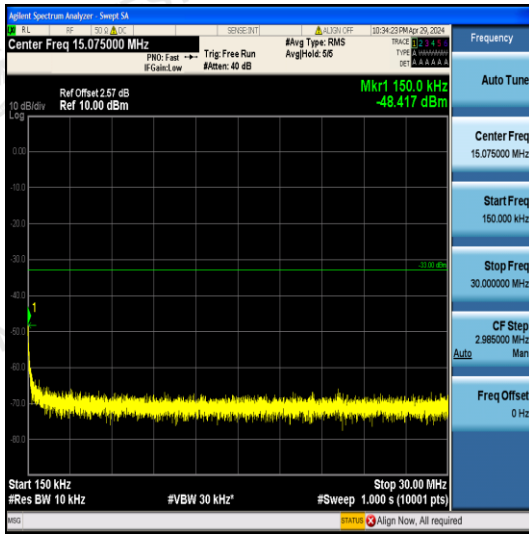

9kHz-150kHz

150kHz-30MHz

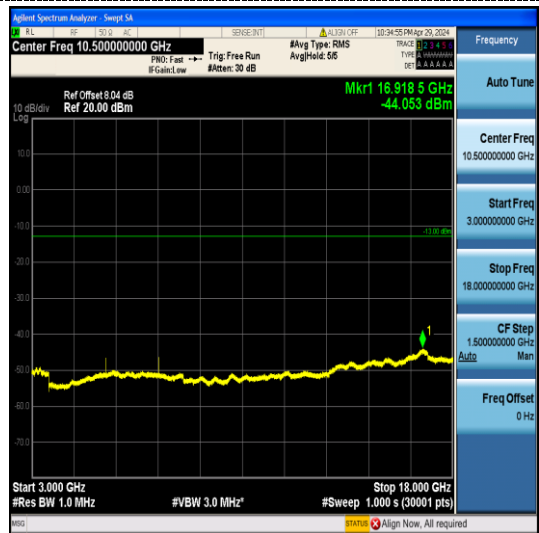

30MHz~1GHz

1GHz~3GHz

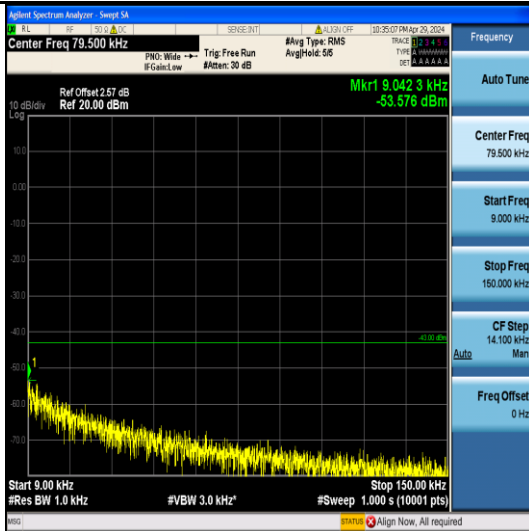

3GHz~18GHz

Channel 661

Test Mode:

GSM1900

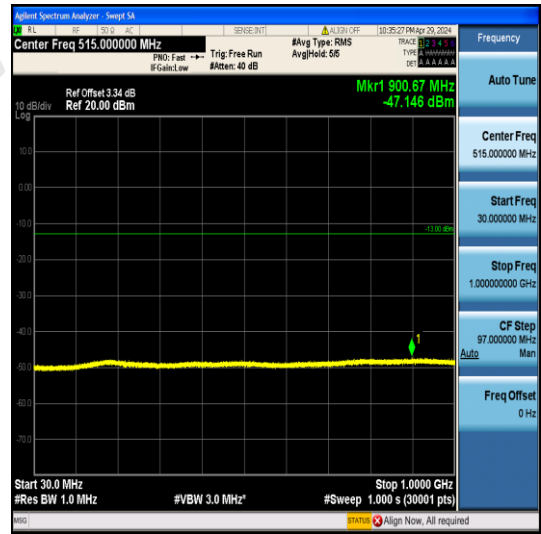
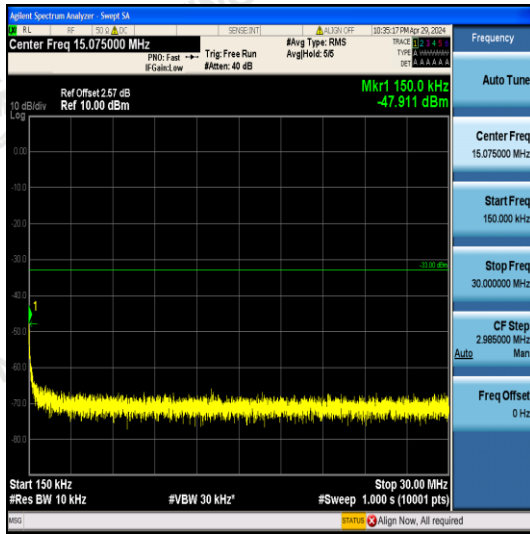

9kHz-150kHz

150kHz-30MHz

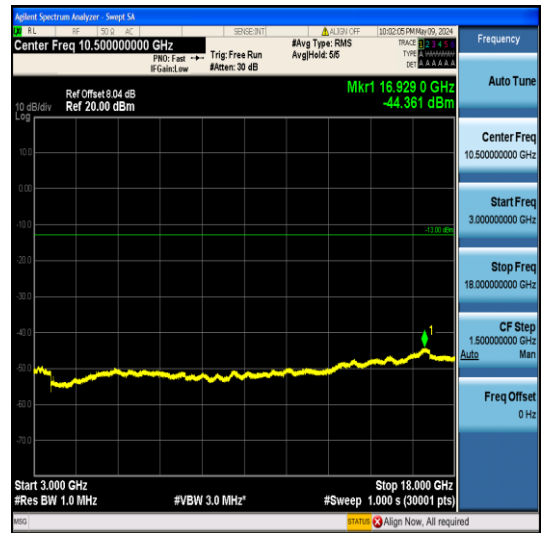

30MHz~1GHz

1GHz~3GHz



3GHz~18GHz

Channel 810

4.6 Frequency Stability Test

TEST APPLICABLE

1. According to FCC Part 2 Section 2.1055 (a)(1), the frequency stability shall be measured with variation of ambient temperature from -30°C to $+50^{\circ}\text{C}$ centigrade.
2. According to FCC Part 2 Section 2.1055 (E) (2), for battery powered equipment, the frequency stability shall be measured with reducing primary supply voltage to the battery operating end point, which is specified by the manufacture.
3. Vary primary supply voltage from 85 to 115 percent of the nominal value for other than hand carried voltage equipment and the end voltage point was 10.8V.

TEST PROCEDURE

In order to measure the carrier frequency under the condition of AFC lock, it is necessary to make measurements with the EUT in a "call mode". This is accomplished with the use of R&S CMU200 DIGITAL RADIO COMMUNICATION TESTER.

1. Measure the carrier frequency at room temperature;
2. Subject the EUT to overnight soak at -30°C ;
3. With the EUT, powered via nominal voltage, connected to the CMU200 and in a simulated call on middle channel of PCS 1900 and GSM850, measure the carrier frequency. These measurements should be made within 2 minutes of Powering up the EUT, to prevent significant self-warming;
4. Repeat the above measurements at 10°C increments from -30°C to $+50^{\circ}\text{C}$. Allow at least 0.5 hours at each temperature, unpowered, before making measurements;
5. Remeasure carrier frequency at room temperature with nominal voltage. Vary supply voltage from minimum voltage to maximum voltage, in 0.1Volt increments remeasuring carrier frequency at each voltage. Pause at nominal voltage for 0.5 hours unpowered, to allow any self-heating to stabilize, before continuing;
6. Subject the EUT to overnight soak at $+50^{\circ}\text{C}$;
7. With the EUT, powered via nominal voltage, connected to the CMU200 and in a simulated call on the centre channel, measure the carrier frequency. These measurements should be made within 2 minutes of Powering up the EUT, to prevent significant self-warming;
8. Repeat the above measurements at 10°C increments from $+50^{\circ}\text{C}$ to -30°C . Allow at least 0.5 hours at each temperature, unpowered, before making measurements;
9. At all temperature levels hold the temperature to $\pm 0.5^{\circ}\text{C}$ during the measurement procedure;

TEST CONFIGURATION

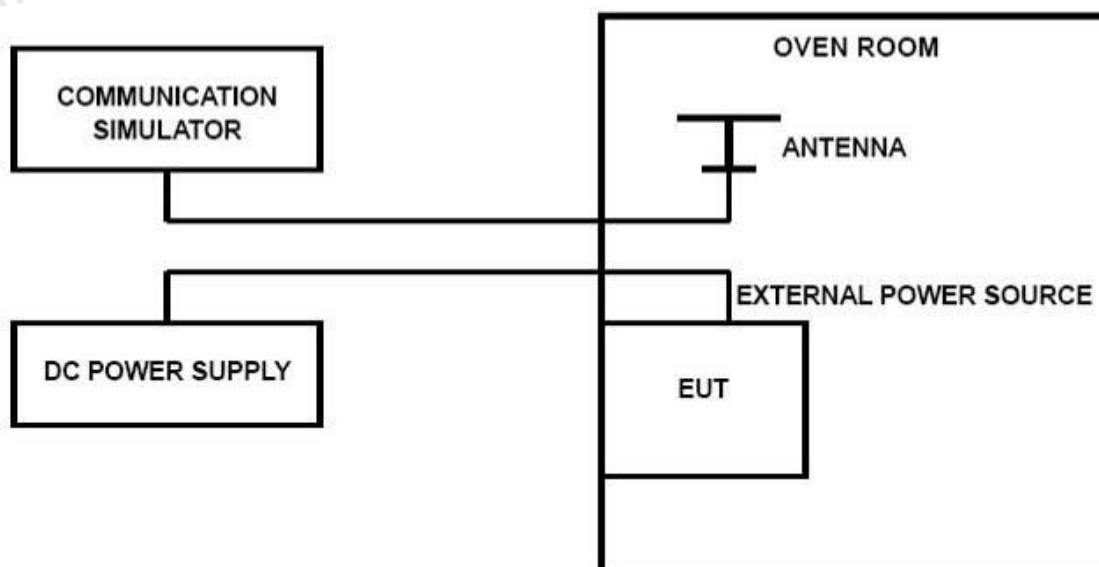

TEST LIMITS***For Hand carried battery powered equipment***

According to the JTC standard the frequency stability of the carrier shall be accurate to within 0.1 ppm of the received frequency from the base station. This accuracy is sufficient to meet Sec. 24.235, Frequency Stability. The frequency stability shall be sufficient to ensure that the fundamental emission stays within the authorized frequency block. As this transceiver is considered "Hand carried, battery powered equipment" Section 2.1055(d)(2) applies. This requires that the lower voltage for frequency stability testing be specified by the manufacturer. This transceiver is specified to operate with an input voltage of between 3.40VDC and 4.20VDC, with a nominal voltage of 3.80 DC. Operation above or below these voltage limits is prohibited by transceiver software in order to prevent improper operation as well as to protect components from overstress. These voltages represent a tolerance of -10 % and +12.5 %. For the purposes of measuring frequency stability these voltage limits are to be used.

For equipment powered by primary supply voltage

According to the JTC standard the frequency stability of the carrier shall be accurate to within 0.1 ppm of the received frequency from the base station. This accuracy is sufficient to meet Sec. 24.235, Frequency Stability. The frequency stability shall be sufficient to ensure that the fundamental emission stays within the authorized frequency block. For this EUT section 2.1055(d)(1) applies. This requires varying primary supply voltage from 85 to 115 percent of the nominal value for other than hand carried battery equipment.

TEST RESULTS

GSM 850 Middle channel=190 channel=836.6MHz					
DC Power	Temperature (°C)	Frequency error(Hz)	Frequency error(ppm)	Limit (ppm)	Verdict
3.85	25	50	0.060	2.50	PASS
3.40	25	32	0.038	2.50	PASS
4.20	25	3	0.004	2.50	PASS
3.85	-30	-45	-0.054	2.50	PASS
3.85	-20	29	0.035	2.50	PASS
3.85	-10	-16	-0.019	2.50	PASS
3.85	0	36	0.043	2.50	PASS
3.85	10	-7	-0.008	2.50	PASS
3.85	20	-48	-0.057	2.50	PASS
3.85	30	21	0.025	2.50	PASS
3.85	40	31	0.037	2.50	PASS
3.85	50	10	0.012	2.50	PASS

GSM 1900 Middle channel=661 channel=1880MHz					
DC Power	Temperature (°C)	Frequency error(Hz)	Frequency error(ppm)	Limit (ppm)	Verdict
3.85	25	-33	-0.018	2.50	PASS
3.40	25	17	0.009	2.50	PASS
4.20	25	-38	-0.020	2.50	PASS
3.85	-30	49	0.026	2.50	PASS
3.85	-20	26	0.014	2.50	PASS
3.85	-10	-20	-0.011	2.50	PASS
3.85	0	-15	-0.008	2.50	PASS
3.85	10	7	0.004	2.50	PASS
3.85	20	-3	-0.002	2.50	PASS
3.85	30	37	0.020	2.50	PASS
3.85	40	29	0.015	2.50	PASS
3.85	50	-6	-0.003	2.50	PASS

GPRS 850 Middle channel=190 channel=836.6MHz					
DC Power	Temperature (°C)	Frequency error(Hz)	Frequency error(ppm)	Limit (ppm)	Verdict
3.85	25	-16	-0.019	2.50	PASS
3.40	25	17	0.020	2.50	PASS
4.20	25	18	0.022	2.50	PASS
3.85	-30	29	0.035	2.50	PASS
3.85	-20	0	0.000	2.50	PASS
3.85	-10	-14	-0.017	2.50	PASS
3.85	0	2	0.002	2.50	PASS
3.85	10	42	0.050	2.50	PASS
3.85	20	-10	-0.012	2.50	PASS
3.85	30	9	0.011	2.50	PASS
3.85	40	34	0.041	2.50	PASS
3.85	50	-13	-0.016	2.50	PASS

GPRS 1900 Middle channel=661 channel=1880MHz					
DC Power	Temperature (°C)	Frequency error(Hz)	Frequency error(ppm)	Limit (ppm)	Verdict
3.85	25	-3	-0.002	2.50	PASS
3.40	25	-12	-0.006	2.50	PASS
4.20	25	-6	-0.003	2.50	PASS
3.85	-30	32	0.017	2.50	PASS
3.85	-20	-48	-0.026	2.50	PASS
3.85	-10	-13	-0.007	2.50	PASS
3.85	0	-18	-0.010	2.50	PASS
3.85	10	-40	-0.021	2.50	PASS
3.85	20	-33	-0.018	2.50	PASS
3.85	30	-32	-0.017	2.50	PASS
3.85	40	9	0.005	2.50	PASS
3.85	50	-7	-0.004	2.50	PASS

4.7 Peak-to-Average Ratio (PAR)

LIMIT

The Peak-to-Average Ratio (PAR) of the transmission may not exceed 13 dB.

TEST CONFIGURATION

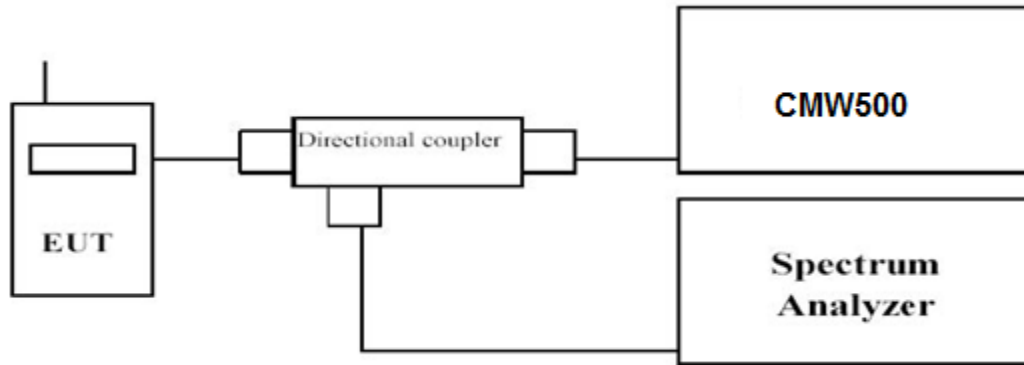

TEST PROCEDURE

Use spectrum to measure the total peak power and record as P_{Pk}. Use spectrum to measure the total average power and record as P_{Avg}. Both the peak and average power levels must be expressed in the same logarithmic units (e.g., dBm).

Determine the PAPR from:

$$PAPR (dB) = P_{Pk} (dBm) - P_{Avg} (dBm).$$

TEST RESULTS

	GSM 850	GPRS 850
Frequency (MHz)	Measured (dB)	Measured (dB)
824.20	9.63	9.55
836.60	9.43	9.49
848.80	9.38	9.74

	GSM 1900	GPRS 1900
Frequency (MHz)	Measured (dB)	Measured (dB)
1850.20	9.45	9.57
1880.00	9.42	9.51
1909.80	9.51	9.69



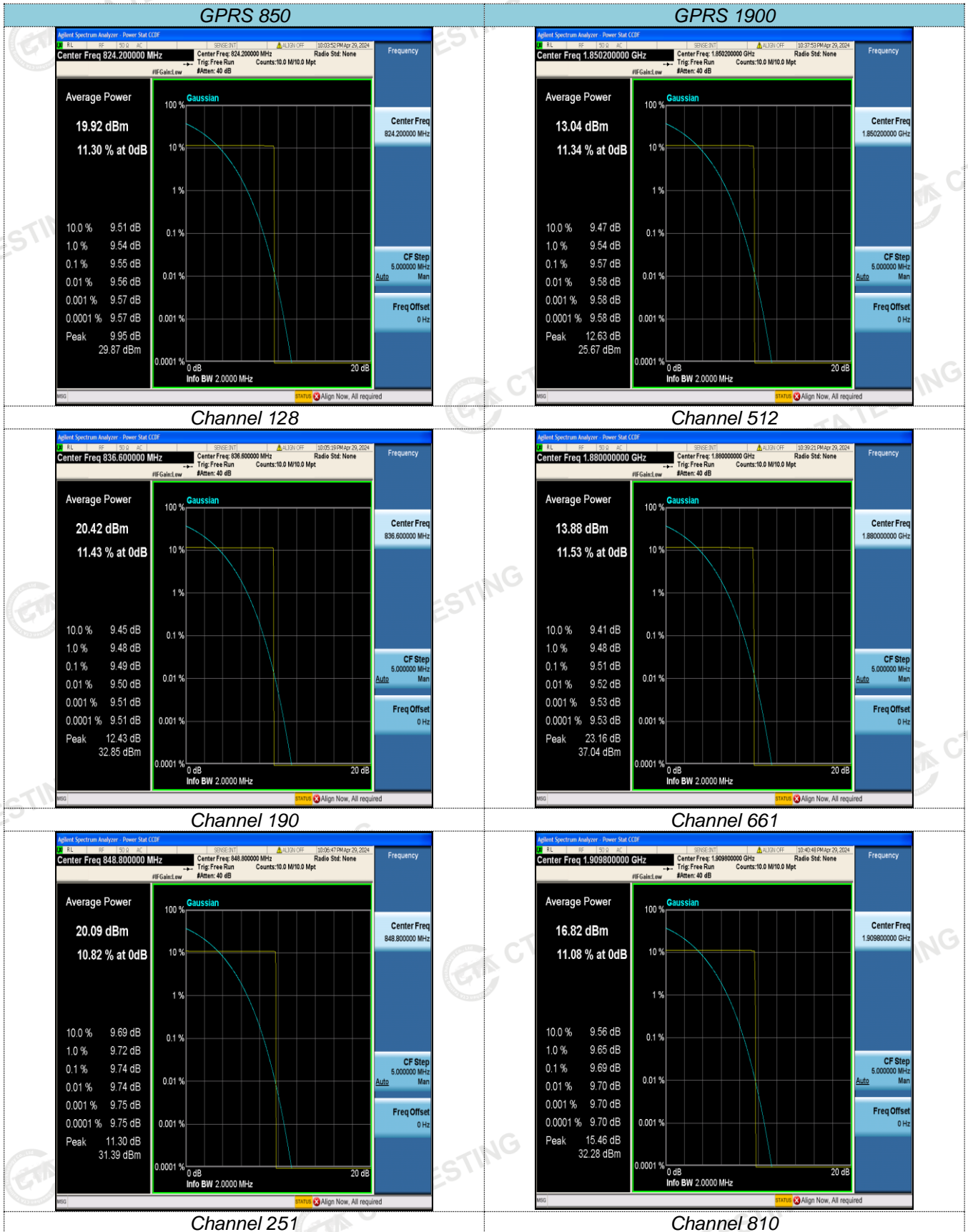

5 Test Setup Photos of the EUT

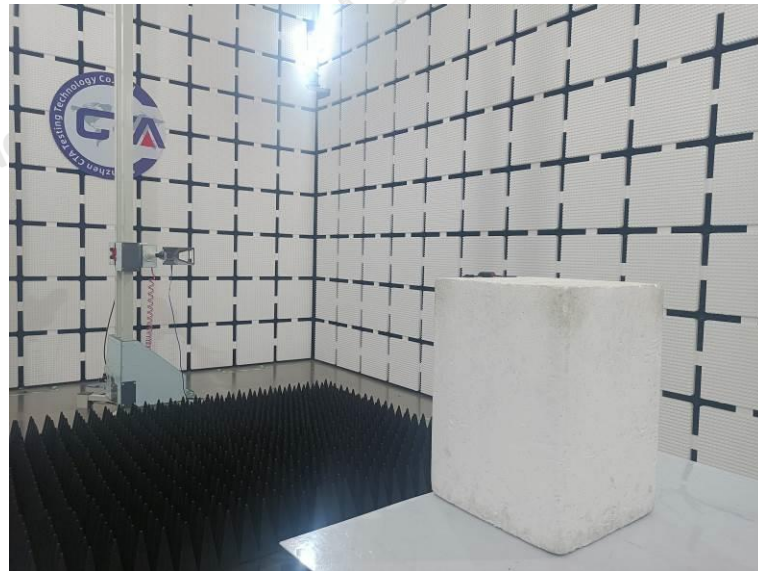
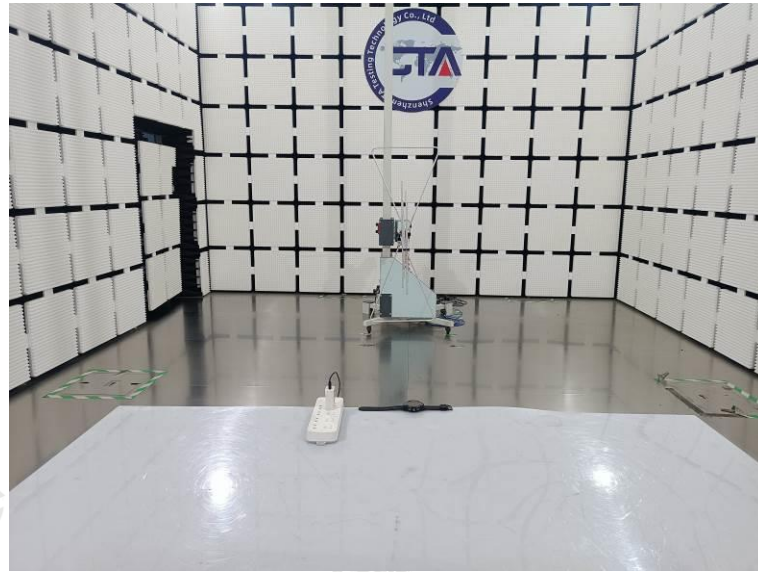

6 External and Internal Photos of the EUT

Reference to the test report No. CTA24041700501.

.....End of Report.....