

FCC SAR EVALUATION REPORT

**In accordance with the requirements of
FCC 47 CFR Part 2(2.1093), ANSI/IEEE C95.1-1992 and
IEEE Std 1528-2013**

Product Name : Smart Phone

Brand Name : IIF150

Model Name : Air2 Ultra

Family Model : N/A

Report No. : S24022803310001

FCC ID : 2A8X4-AIR2ULTRA

Prepared for

HONG KONG YO YOUNG INTELLIGENT CO., LIMITED
19H MAXGRAND PLAZA NO.3 TAIYAU STREET SAN PO KONG,KOWLOONHONG
KONG

Prepared by

Shenzhen NTEK Testing Technology Co., Ltd.
1/F, Building E, Fenda Science Park, Sanwei Community,
Xixiang Street Bao'an District, Shenzhen 518126 P.R. China
Tel. 400-800-6106, 0755-2320 0050, 0755-2320 0090
Website: <http://www.ntek.org.cn>

TEST RESULT CERTIFICATION

Applicant's name HONG KONG YO YOUNG INTELLIGENT CO., LIMITED
Address 19H MAXGRAND PLAZA NO.3 TAIYAU STREET SAN PO
KONG,KOWLOONHONG KONG

Manufacturer's Name . HONG KONG YO YOUNG INTELLIGENT CO., LIMITED
Address 19H MAXGRAND PLAZA NO.3 TAIYAU STREET SAN PO
KONG,KOWLOONHONG KONG

Product description

Product name Smart Phone
Brand Name Air2 Ultra
Model and/or type reference IIIF150
Family Model N/A
FCC 47 CFR Part 2(2.1093)
ANSI/IEEE C95.1-1992

Standards IEEE Std 1528-2013
Published RF exposure KDB procedures

This device described above has been tested by Shenzhen NTEK. In accordance with the measurement methods and procedures specified in IEEE Std 1528-2013 and KDB 865664 D01. Testing has shown that this device is capable of compliance with localized specific absorption rate (SAR) specified in FCC 47 CFR Part 2(2.1093) and ANSI/IEEE C95.1-1992. The test results in this report apply only to the tested sample of the stated device/equipment. Other similar device/equipment will not necessarily produce the same results due to production tolerance and measurement uncertainties.

This report shall not be reproduced except in full, without the written approval of Shenzhen NTEK, this document may be altered or revised by Shenzhen NTEK, personal only, and shall be noted in the revision of the document.

Test Sample Number S240228033001

Date of Test

Date (s) of performance of tests.. Feb. 29, 2024 ~ Mar. 17, 2024

Date of Issue..... Apr. 12, 2024

Test Result..... Pass

Prepared By: Jack Li
Jack Li
(Project Engineer)

Reviewed By: Aaron Cheng
Aaron Cheng
(Supervisor)

Approved By: Alex Li
Alex Li
(Manager)

※ ※ **Revision History** ※ ※

REV.	DESCRIPTION	ISSUED DATE	REMARK
Rev.1.0	Initial Test Report Release	Apr. 12, 2024	Jack Li

TABLE OF CONTENTS

1. General Information	6
1.1. RF exposure limits	6
1.2. Statement of Compliance.....	7
1.3. EUT Description	7
1.4. Test specification(s)	9
1.5. Ambient Condition.....	9
2. SAR Measurement System	10
2.1. SATIMO SAR Measurement Set-up Diagram.....	10
2.2. Robot	11
2.3. E-Field Probe.....	12
2.3.1. E-Field Probe Calibration.....	12
2.4. SAM phantoms	13
2.4.1. Technical Data	14
2.5. Device Holder	15
2.6. Test Equipment List	16
3. SAR Measurement Procedures	19
3.1. Power Reference.....	19
3.2. Area scan & Zoom scan	19
3.3. Description of interpolation/extrapolation scheme	21
3.4. Volumetric Scan	21
3.5. Power Drift	21
4. System Verification Procedure.....	22
4.1. Tissue Verification.....	22
4.1.1. Tissue Dielectric Parameter Check Results	23
4.2. System Verification Procedure.....	24
4.2.1. System Verification Results	25
5. SAR Measurement variability and uncertainty	26
5.1. SAR measurement variability	26
5.2. SAR measurement uncertainty.....	26
6. RF Exposure Positions	27
6.1. Ear and handset reference point.....	27
6.2. Definition of the cheek position	27
6.3. Definition of the tilt position.....	29
6.4. Body Worn Accessory	29
6.5. Wireless Router Devices.....	30
7. RF Output Power	31
7.1. GSM Conducted Power	31
7.2. WCDMA Conducted Power.....	31
7.3. LTE Conducted Power.....	33

7.4. NR SA Power	55
7.5. WLAN & Bluetooth Output Power.....	62
7.6. NFC	66
8. Antenna Location.....	67
9. Stand-alone SAR test exclusion	68
10. SAR Results	68
10.1. SAR measurement Result	68
10.1.1. SAR measurement Result of GSM850.....	68
10.1.2. SAR measurement Result of GSM1900.....	70
10.1.3. SAR measurement Result of WCDMA Band 2.....	71
10.1.4. SAR measurement Result of WCDMA Band 4.....	72
10.1.5. SAR measurement Result of WCDMA Band 5.....	73
10.1.6. SAR measurement Result of LTE Band 2	74
10.1.7. SAR measurement Result of LTE Band 4	75
10.1.8. SAR measurement Result of LTE Band 5	77
10.1.9. SAR measurement Result of LTE Band 7	79
10.1.10. SAR measurement Result of LTE Band 12	81
10.1.11. SAR measurement Result of LTE Band 13	83
10.1.12. SAR measurement Result of LTE Band 17	85
10.1.13. SAR measurement Result of LTE Band 18	87
10.1.14. SAR measurement Result of LTE Band 19	88
10.1.15. SAR measurement Result of LTE Band 25	90
10.1.16. SAR measurement Result of LTE Band 38	92
10.1.17. SAR measurement Result of LTE Band 41	94
10.1.18. SAR measurement Result of NR n38.....	96
10.1.19. SAR measurement Result of NR n77.....	97
10.1.20. SAR measurement Result of WLAN2.4G	98
10.1.21. SAR measurement Result of WLAN5.2G	101
10.1.22. SAR measurement Result of WLAN5.3G	104
10.1.23. SAR measurement Result of WLAN5.6G	108
10.1.24. SAR measurement Result of WLAN5.8G	111
10.2. Simultaneous Transmission Analysis	115
1. Appendix A. Photo documentation	116
2. Appendix B. System Check Plots	117
1. Appendix C. Plots of High SAR Measurement.....	140
2. Appendix D. Calibration Certificate	258

1. General Information

1.1. RF exposure limits

(A).Limits for Occupational/Controlled Exposure (W/kg)

Whole-Body	Partial-Body	Hands, Wrists, Feet and Ankles
0.4	8.0	20.0

(B).Limits for General Population/Uncontrolled Exposure (W/kg)

Whole-Body	Partial-Body	Hands, Wrists, Feet and Ankles
0.08	1.6	4.0

NOTE: **Whole-Body SAR** is averaged over the entire body, **partial-body SAR** is averaged over any 1 gram of tissue defined as a tissue volume in the shape of a cube. **SAR for hands, wrists, feet and ankles** is averaged over any 10 grams of tissue defined as a tissue volume in the shape of a cube.

Occupational/Controlled Environments:

Are defined as locations where there is exposure that may be incurred by people who are aware of the potential for exposure, (i.e. as a result of employment or occupation).

General Population/Uncontrolled Environments:

Are defined as locations where there is the exposure of individuals who have no knowledge or control of their exposure.

NOTE
HEAD AND TRUNK LIMIT
1.6 W/kg
APPLIED TO THIS EUT

1.2. Statement of Compliance

The maximum results of Specific Absorption Rate (SAR) found during testing for Air2 Ultra are as follows.

RF Exposure Conditions		Max Reported SAR Value(W/kg)
1-g Head		0.747
1-g Body-Worn (Separation distance of 10mm)		0.715
1-g Hotspot (Separation distance of 10mm)		0.715
Max Simultaneous Tx	Head	1.137
	Body-Worn	0.926
	Hotspot	0.926

Note: The Max Simultaneous Tx is calculated based on the same configuration and test position.

This device is in compliance with Specific Absorption Rate (SAR) for general population/uncontrolled exposure limits (1.6 W/kg) specified in FCC 47 CFR Part 2(2.1093) and ANSI/IEEE C95.1-1992, and had been tested in accordance with the measurement methods and procedures specified in IEEE Std 1528-2013 & KDB 865664 D01.

1.3. EUT Description

Device Information	
Product Name	Smart Phone
Brand Name	IIIF150
Model Name	Air2 Ultra
Family Model	N/A
Model Difference	N/A
FCC ID	2A8X4-AIR2ULTRA
Device Phase	Identical Prototype
Exposure Category	General population / Uncontrolled environment
Antenna Type	LDS Antenna
Battery Information	DC 3.89V,5000mAh, 19.45Wh
HW Version	Air2 Ultra_Mainboard_P1
SW Version	ASW3100_YO_2201_T0066
Device Operating Configurations	
Supporting Mode(s)	GSM850/1900,WCDMABand2/4/5,LTEBand2/4/5/7/12/13/17/18/19/25/38/41, NR SA n38/n77, WLAN 2.4G/5G, Bluetooth, NFC
Test Modulation	GSM(GMSK/8PSK), WCDMA(QPSK), LTE(QPSK/16QAM), NR(DFT-s-OFDM:PI/2 BPSK/QPSK/16-QAM/64QAM/256QAM CP-OFDM: QPSK/16-QAM/64QAM/256QAM), WLAN(DSSS/OFDM), Bluetooth(GFSK, π/4-DQPSK, 8DPSK), NFC(ASK)

Device Class	B		
Operating Frequency Range(s)	Band	Tx (MHz)	Rx (MHz)
	GSM 850	824-849	869-894
	GSM 1900	1850-1910	1930-1990
	WCDMA Band 2	1850-1910	1930-1990
	WCDMA Band 4	1710-1755	2110-2155
	WCDMA Band 5	824-849	869-894
	LTE Band 2	1850-1910	1930-1990
	LTE Band 4	1710-1755	2110-2155
	LTE Band 5	824-849	869-894
	LTE Band 7	2500-2570	2620-2690
	LTE Band 12	699-716	729-746
	LTE Band 13	777-787	746-756
	LTE Band 17	704-716	734-746
	LTE Band 18	815-830	860-875
	LTE Band 19	830-845	875-890
	LTE Band 25	1850-1915	1930-1995
	LTE Band 38	2570-2620	
	LTE Band 41	2535-2655	
	NR n38	2570-2620	
	NR n77	3700-3980	
	WLAN 2.4G	2412-2462	
	WLAN 5.2G	5180-5240	
	WLAN 5.3G	5250-5350	
WLAN 5.6G	5470-5725		
WLAN 5.8G	5745-5825		
NFC	13.56		
Bluetooth	2402-2480		
GPRS Multislot Class(12)	Max Number of Timeslots in Uplink		4
	Max Number of Timeslots in Downlink		4
	Max Total Timeslot		5
EGPRS Multislot Class(12)	Max Number of Timeslots in Uplink		4
	Max Number of Timeslots in Downlink		4
	Max Total Timeslot		5
Power Class	4, tested with power level 5(GSM 850)		
	1, tested with power level 0(GSM 1900)		
	3, tested with power control "all 1"(WCDMA Band 2)		
	3, tested with power control "all 1"(WCDMA Band 4)		
	3, tested with power control "all 1"(WCDMA Band 5)		
	3, tested with power control all Max.(LTE Band 2)		

3, tested with power control all Max.(LTE Band 4)
3, tested with power control all Max.(LTE Band 5)
3, tested with power control all Max.(LTE Band 7)
3, tested with power control all Max.(LTE Band 12)
3, tested with power control all Max.(LTE Band 13)
3, tested with power control all Max.(LTE Band 17)
3, tested with power control all Max.(LTE Band 18)
3, tested with power control all Max.(LTE Band 19)
3, tested with power control all Max.(LTE Band 25)
3, tested with power control all Max.(LTE Band 38)
3, tested with power control all Max.(LTE Band 41)
3, tested with power control all Max.(NR n38)
3, tested with power control all Max.(NR n77)

1.4. Test specification(s)

FCC 47 CFR Part 2(2.1093)
ANSI/IEEE C95.1-1992
IEEE Std 1528-2013
KDB 865664 D01 SAR measurement 100 MHz to 6 GHz
KDB 865664 D02 RF Exposure Reporting
KDB 447498 D01 General RF Exposure Guidance
KDB 248227 D01 802.11 Wi-Fi SAR
KDB 941225 D01 3G SAR Procedures
KDB 941225 D05 SAR for LTE Devices
KDB 941225 D06 Hotspot SAR
KDB 648474 D04 Handset SAR

1.5. Ambient Condition

Ambient temperature	20°C – 24°C
Relative Humidity	30% – 70%

2. SAR Measurement System

2.1. SATIMO SAR Measurement Set-up Diagram

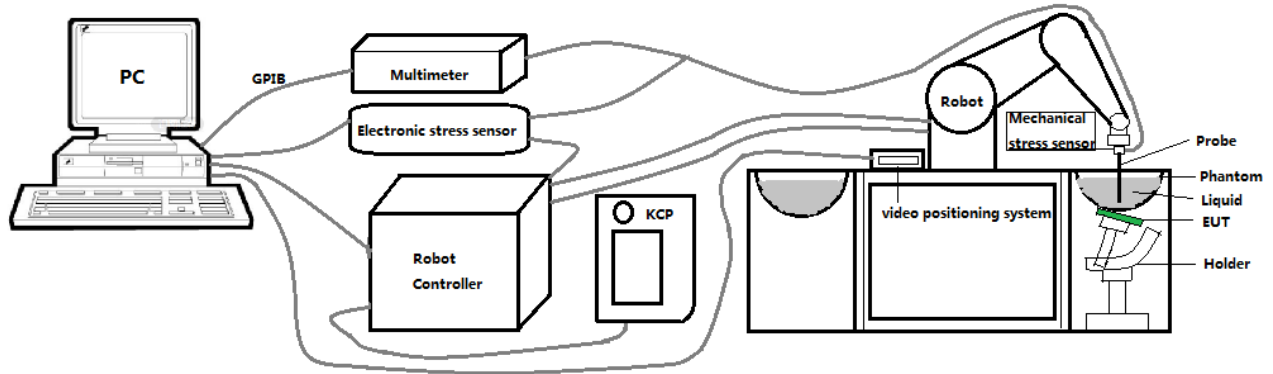

These measurements were performed with the automated near-field scanning system OPENSAR from SATIMO. The system is based on a high precision robot (working range: 901 mm), which positions the probes with a positional repeatability of better than ± 0.03 mm. The SAR measurements were conducted with dosimetric probe (manufactured by SATIMO), designed in the classical triangular configuration and optimized for dosimetric evaluation.

The first step of the field measurement is the evaluation of the voltages induced on the probe by the device under test. Probe diode detectors are nonlinear. Below the diode compression point, the output voltage is proportional to the square of the applied E-field; above the diode compression point, it is linear to the applied E-field. The compression point depends on the diode, and a calibration procedure is necessary for each sensor of the probe.

The Keithley multimeter reads the voltage of each sensor and send these three values to the PC. The corresponding E field value is calculated using the probe calibration factors, which are stored in the working directory. This evaluation includes linearization of the diode characteristics. The field calculation is done separately for each sensor. Each component of the E field is displayed on the "Dipole Area Scan Interface" and the total E field is displayed on the "3D Interface"

2.2. Robot

The SATIMO SAR system uses the high precision robots from KUKA. For the 6-axis controller system, the robot controller version (KUKA) from KUKA is used. The KUKA robot series have many features that are important for our application:



- High precision (repeatability ± 0.03 mm)
- High reliability (industrial design)
- Jerk-free straight movements
- Low ELF interference (the closed metallic construction shields against motor control fields)

2.3. E-Field Probe

This E-field detection probe is composed of three orthogonal dipoles linked to special Schottky diodes with low detection thresholds. The probe allows the measurement of electric fields in liquids such as the one defined in the IEEE and CENELEC standards.

For the measurements the Specific Dosimetric E-Field Probe 3423-EPGO-426 with following specifications is used



- Dynamic range: 0.01-100 W/kg
 - Tip Diameter : 2.5 mm
 - Distance between probe tip and sensor center: 1 mm
 - Distance between sensor center and the inner phantom surface: 2 mm (repeatability better than ± 1 mm).
 - Probe linearity: ± 0.06 dB
 - Axial isotropy: ± 0.01 dB
 - Hemispherical Isotropy: ± 0.01 dB
 - Calibration range: 650MHz to 5900MHz for head & body simulating liquid.
 - Lower detection limit: 8mW/kg
- Angle between probe axis (evaluation axis) and surface normal line: less than 30° .

2.3.1. E-Field Probe Calibration

Each probe needs to be calibrated according to a dosimetric assessment procedure with accuracy better than $\pm 10\%$. The spherical isotropy shall be evaluated and within ± 0.25 dB. The sensitivity parameters (Norm X, Norm Y, and Norm Z), the diode compression parameter (DCP) and the conversion factor (Conv F) of the probe are tested. The calibration data can be referred to appendix D of this report.

2.4. SAM phantoms

Photo of SAM phantom SN 16/15 SAM119



The SAM phantom is used to measure the SAR relative to people exposed to electro-magnetic field radiated by Smart Phones.

2.4.1. Technical Data

Serial Number	Shell thickness	Filling volume	Dimensions	Positionner Material	Permittivity	Loss Tangent
SN 16/15 SAM119	2 mm ±0.2 mm	27 liters	Length:1000 mm Width:500 mm Height:200 mm	Gelcoat with fiberglass	3.4	0.02

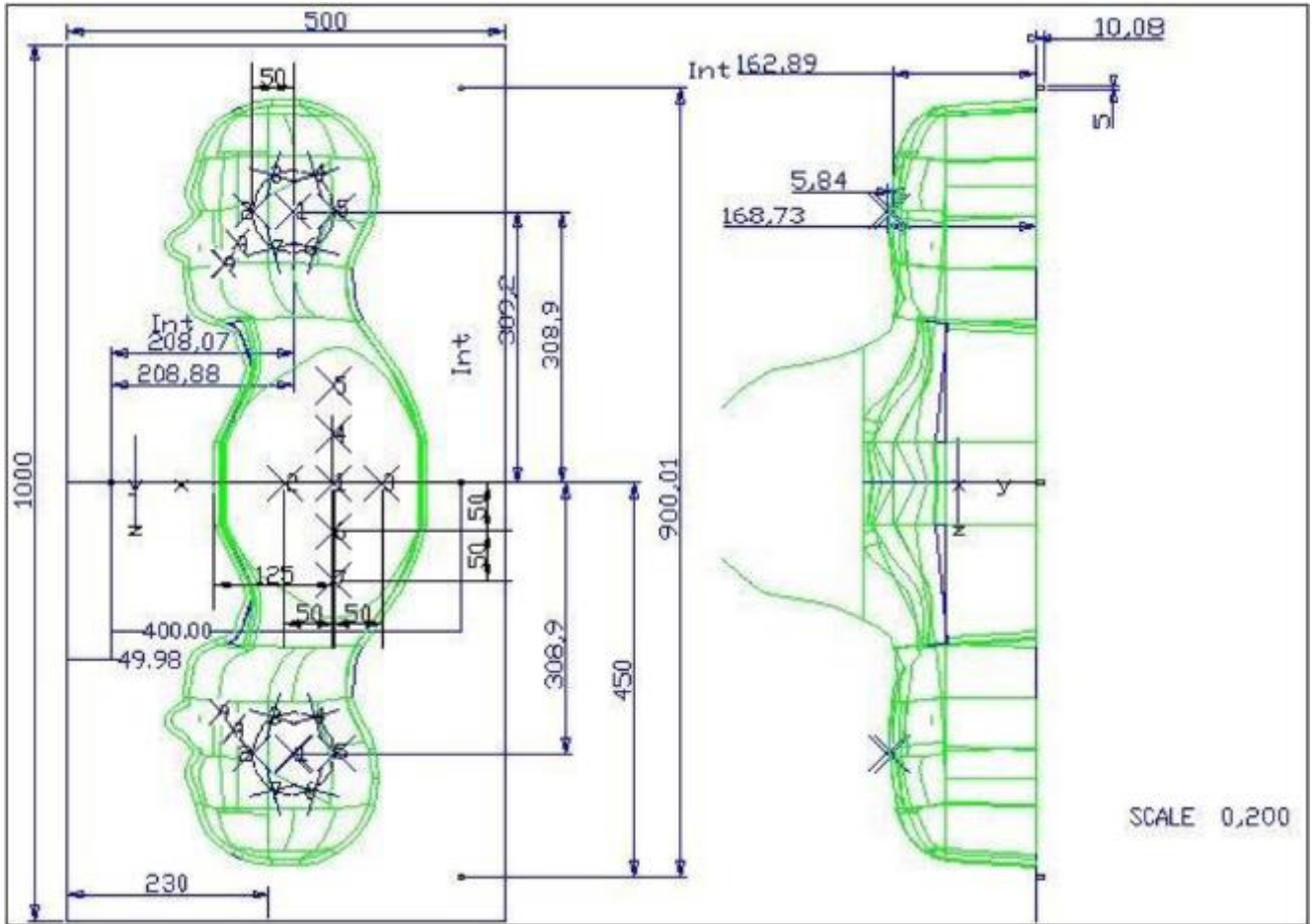

Serial Number	Left Head(mm)		Right Head(mm)		Flat Part(mm)	
SN 16/15 SAM119	2	2.02	2	2.08	1	2.09
	3	2.05	3	2.06	2	2.06
	4	2.07	4	2.07	3	2.08
	5	2.08	5	2.08	4	2.10
	6	2.05	6	2.07	5	2.10
	7	2.05	7	2.05	6	2.07
	8	2.07	8	2.06	7	2.07
	9	2.08	9	2.06	-	-

The test, based on ultrasonic system, allows measuring the thickness with an accuracy of 10 µm.

2.5. Device Holder

The positioning system allows obtaining cheek and tilting position with a very good accuracy. In compliance with CENELEC, the tilt angle uncertainty is lower than 1 degree.

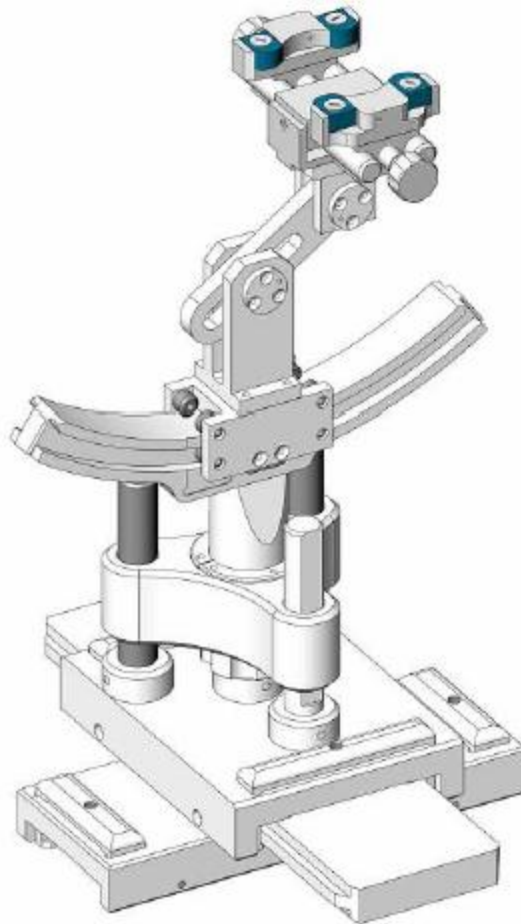

Serial Number	Holder Material	Permittivity	Loss Tangent
SN 16/15 MSH100	Delrin	3.7	0.005

2.6. Test Equipment List

This table gives a complete overview of the SAR measurement equipment.

Devices used during the test described are marked

	Manufacturer	Name of Equipment	Type/Model	Serial Number	Calibration	
					Last Cal.	Due Date
<input checked="" type="checkbox"/>	MVG	E FIELD PROBE	SSE2	3423-EPGO-426	Sep. 18, 2023	Sep. 17, 2024
<input checked="" type="checkbox"/>	MVG	750 MHz Dipole	SID750	SN 03/15 DIP 0G750-355	Feb. 21, 2024	Feb. 20, 2027
<input checked="" type="checkbox"/>	MVG	835 MHz Dipole	SID835	SN 03/15 DIP 0G835-347	Feb. 21, 2024	Feb. 20, 2027
<input type="checkbox"/>	MVG	900 MHz Dipole	SID900	SN 03/15 DIP 0G900-348	Feb. 21, 2024	Feb. 20, 2027
<input checked="" type="checkbox"/>	MVG	1800 MHz Dipole	SID1800	SN 03/15 DIP 1G800-349	Feb. 21, 2024	Feb. 20, 2027
<input checked="" type="checkbox"/>	MVG	1900 MHz Dipole	SID1900	SN 03/15 DIP 1G900-350	Feb. 21, 2024	Feb. 20, 2027
<input type="checkbox"/>	MVG	2000 MHz Dipole	SID2000	SN 03/15 DIP 2G000-351	Feb. 21, 2024	Feb. 20, 2027
<input type="checkbox"/>	MVG	2300 MHz Dipole	SID2300	SN 03/16 DIP 2G300-358	Feb. 21, 2024	Feb. 20, 2027
<input checked="" type="checkbox"/>	MVG	2450 MHz Dipole	SID2450	SN 03/15 DIP 2G450-352	Feb. 21, 2024	Feb. 20, 2027
<input checked="" type="checkbox"/>	MVG	2600 MHz Dipole	SID2600	SN 03/15 DIP 2G600-356	Feb. 21, 2024	Feb. 20, 2027
<input type="checkbox"/>	MVG	3500 MHz Dipole	SID3500	SN 09/12 DIP 3G500-360	Oct. 15, 2022	Oct. 14, 2025
<input checked="" type="checkbox"/>	MVG	3700 MHz Dipole	SID3700	SN 09/12 DIP 3G/700-361	Oct. 15, 2022	Oct. 14, 2025
<input checked="" type="checkbox"/>	MVG	5000 MHz Dipole	SWG5500	SN 13/14 WGA 33	Feb. 21, 2024	Feb. 20, 2027
<input checked="" type="checkbox"/>	MVG	Liquid measurement Kit	SCLMP	SN 21/15 OCPG 72	NCR	NCR
<input checked="" type="checkbox"/>	MVG	Power Amplifier	N.A	AMPLISAR_28/14_003	NCR	NCR
<input checked="" type="checkbox"/>	KEITHLEY	Millivoltmeter	2000	4072790	NCR	NCR
<input checked="" type="checkbox"/>	R&S	Universal radio communication tester	CMU200	117858	May 29, 2023	May 28, 2024

<input checked="" type="checkbox"/>	R&S	Wideband radio communication tester	CMW500	103917	May 29, 2023	May 28, 2024
<input checked="" type="checkbox"/>	HP	Network Analyzer	8753D	3410J01136	May 29, 2023	May 28, 2024
<input checked="" type="checkbox"/>	Agilent	MXG Vector Signal Generator	N5182A	MY47070317	May 29, 2023	May 28, 2024
<input checked="" type="checkbox"/>	Agilent	Power meter	E4419B	MY45102538	May 29, 2023	May 28, 2024
<input checked="" type="checkbox"/>	Agilent	Power sensor	E9301A	MY41495644	May 29, 2023	May 28, 2024
<input checked="" type="checkbox"/>	Agilent	Power sensor	E9301A	US39212148	May 29, 2023	May 28, 2024
<input checked="" type="checkbox"/>	MCLI/USA	Directional Coupler	CB11-20	0D2L51502	Jul. 04, 2023	Jul. 03, 2024
<input checked="" type="checkbox"/>	N/A	Thermometer	N/A	LES-085	Mar. 27, 2023	Mar. 26, 2026
<input checked="" type="checkbox"/>	MVG	SAM Phantom	SSM2	SN 16/15 SAM119	NCR	NCR
<input checked="" type="checkbox"/>	MVG	Device Holder	SMPPD	SN 16/15 MSH100	NCR	NCR
<input checked="" type="checkbox"/>	Shenzhen Tianxu Communication Technology Co., Ltd.	Human Simulating Liquid	Head 750	Head 750	NCR	NCR
<input checked="" type="checkbox"/>	Shenzhen Tianxu Communication Technology Co., Ltd.	Human Simulating Liquid	Head 835	Head 835	NCR	NCR
<input checked="" type="checkbox"/>	Shenzhen Tianxu Communication Technology Co., Ltd.	Human Simulating Liquid	Head 1800	Head 1800	NCR	NCR
<input checked="" type="checkbox"/>	Shenzhen Tianxu Communication Technology Co., Ltd.	Human Simulating Liquid	Head 1900	Head 1900	NCR	NCR
<input checked="" type="checkbox"/>	Shenzhen	Human	Head 2450	Head 2450	NCR	NCR

	Tianxu Communication Technology Co., Ltd.	Simulating Liquid				
<input checked="" type="checkbox"/>	Shenzhen Tianxu Communication Technology Co., Ltd.	Human Simulating Liquid	Head 2600	Head 2600	NCR	NCR
<input checked="" type="checkbox"/>	Shenzhen Tianxu Communication Technology Co., Ltd.	Human Simulating Liquid	Head 3700	Head 3700	NCR	NCR
<input checked="" type="checkbox"/>	Shenzhen Tianxu Communication Technology Co., Ltd.	Human Simulating Liquid	Head 5200	Head 5200	NCR	NCR
<input checked="" type="checkbox"/>	Shenzhen Tianxu Communication Technology Co., Ltd.	Human Simulating Liquid	Head 5400	Head 5400	NCR	NCR
<input checked="" type="checkbox"/>	Shenzhen Tianxu Communication Technology Co., Ltd.	Human Simulating Liquid	Head 5600	Head 5600	NCR	NCR
<input checked="" type="checkbox"/>	Shenzhen Tianxu Communication Technology Co., Ltd.	Human Simulating Liquid	Head 5800	Head 5800	NCR	NCR

3. SAR Measurement Procedures

The measurement procedures are as follows:

<Conducted power measurement>

- (a) For WWAN power measurement, use base station simulator to configure EUT WWAN transmission in conducted connection with RF cable, at maximum power in each supported wireless interface and frequency band.
- (b) Read the WWAN RF power level from the base station simulator.
- (c) For Wi-Fi/BT power measurement, use engineering software to configure EUT Wi-Fi/BT continuously transmission, at maximum RF power in each supported wireless interface and frequency band.
- (d) Connect EUT RF port through RF cable to the power meter, and measure Wi-Fi/BT output power.

<SAR measurement>

- (a) Use base station simulator to configure EUT WWAN transmission in radiated connection, and engineering software to configure EUT Wi-Fi/BT continuously transmission, at maximum RF power, in the highest power channel.
- (b) Place the EUT in the positions as Appendix A demonstrates.
- (c) Set scan area, grid size and other setting on the OPENSAR software.
- (d) Measure SAR results for the highest power channel on each testing position.
- (e) Find out the largest SAR result on these testing positions of each band.
- (f) Measure SAR results for other channels in worst SAR testing position if the reported SAR of highest power channel is larger than 0.8 W/kg.

According to the test standard, the recommended procedure for assessing the peak spatial-average SAR value consists of the following steps:

- (a) Power reference measurement
- (b) Area scan
- (c) Zoom scan
- (d) Power drift measurement

3.1. Power Reference

The Power Reference Measurement and Power Drift Measurements are for monitoring the power drift of the device under test in the batch process. The minimum distance of probe sensors to surface determines the closest measurement point to phantom surface. This distance cannot be smaller than the distance of sensor calibration points to probe tip as defined in the probe properties.

3.2. Area scan & Zoom scan

The area scan is a 2D scan to find the hot spot location on the DUT. The zoom scan is a 3D scan

above the hot spot to calculate the 1g and 10g SAR value.

Measurement of the SAR distribution with a grid of 8 to 16 mm * 8 to 16 mm and a constant distance to the inner surface of the phantom. Since the sensors cannot directly measure at the inner phantom surface, the values between the sensors and the inner phantom surface are extrapolated. With these values the area of the maximum SAR is calculated by an interpolation scheme. Around this point, a cube of 30 * 30 * 30 mm or 32 * 32 * 32 mm is assessed by measuring 5 or 8 * 5 or 8 * 4 or 5 mm. With these data, the peak spatial-average SAR value can be calculated.

From the scanned SAR distribution, identify the position of the maximum SAR value, in addition identify the positions of any local maxima with SAR values within 2 dB of the maximum value that will not be within the zoom scan of other peaks; additional peaks shall be measured only when the primary peak is within 2 dB of the SAR compliance limit (e.g., 1 W/kg for 1,6 W/kg 1 g limit, or 1,26 W/kg for 2 W/kg, 10 g limit).

Area scan & Zoom scan scan parameters extracted from FCC KDB 865664 D01 SAR measurement 100 MHz to 6 GHz.

		≤ 3 GHz	> 3 GHz	
Maximum distance from closest measurement point (geometric center of probe sensors) to phantom surface		5 ± 1 mm	$\frac{1}{2} \cdot \delta \cdot \ln(2) \pm 0.5$ mm	
Maximum probe angle from probe axis to phantom surface normal at the measurement location		30° ± 1°	20° ± 1°	
Maximum area scan spatial resolution: Δx_{Area} , Δy_{Area}		≤ 2 GHz: ≤ 15 mm 2 – 3 GHz: ≤ 12 mm	3 – 4 GHz: ≤ 12 mm 4 – 6 GHz: ≤ 10 mm	
		When the x or y dimension of the test device, in the measurement plane orientation, is smaller than the above, the measurement resolution must be ≤ the corresponding x or y dimension of the test device with at least one measurement point on the test device.		
Maximum zoom scan spatial resolution: Δx_{Zoom} , Δy_{Zoom}		≤ 2 GHz: ≤ 8 mm 2 – 3 GHz: ≤ 5 mm*	3 – 4 GHz: ≤ 5 mm* 4 – 6 GHz: ≤ 4 mm*	
Maximum zoom scan spatial resolution, normal to phantom surface	uniform grid: $\Delta z_{Zoom}(n)$	≤ 5 mm	3 – 4 GHz: ≤ 4 mm 4 – 5 GHz: ≤ 3 mm 5 – 6 GHz: ≤ 2 mm	
	graded grid	$\Delta z_{Zoom}(1)$: between 1 st two points closest to phantom surface	≤ 4 mm	3 – 4 GHz: ≤ 3 mm 4 – 5 GHz: ≤ 2.5 mm 5 – 6 GHz: ≤ 2 mm
		$\Delta z_{Zoom}(n>1)$: between subsequent points	≤ 1.5 · $\Delta z_{Zoom}(n-1)$	
Minimum zoom scan volume	x, y, z	≥ 30 mm	3 – 4 GHz: ≥ 28 mm 4 – 5 GHz: ≥ 25 mm 5 – 6 GHz: ≥ 22 mm	

Note: δ is the penetration depth of a plane-wave at normal incidence to the tissue medium; see draft standard IEEE P1528-2011 for details.

* When zoom scan is required and the *reported* SAR from the *area scan based 1-g SAR estimation* procedures of KDB 447498 is ≤ 1.4 W/kg, ≤ 8 mm, ≤ 7 mm and ≤ 5 mm zoom scan resolution may be applied, respectively, for 2 GHz to 3 GHz, 3 GHz to 4 GHz and 4 GHz to 6 GHz.

3.3. Description of interpolation/extrapolation scheme

The local SAR inside the phantom is measured using small dipole sensing elements inside a probe body. The probe tip must not be in contact with the phantom surface in order to minimise measurements errors, but the highest local SAR will occur at the surface of the phantom.

An extrapolation is using to determinate this highest local SAR values. The extrapolation is based on a fourth-order least-square polynomial fit of measured data. The local SAR value is then extrapolated from the liquid surface with a 1 mm step.

The measurements have to be performed over a limited time (due to the duration of the battery) so the step of measurement is high. It could vary between 5 and 8 mm. To obtain an accurate assessment of the maximum SAR averaged over 10 grams and 1 gram requires a very fine resolution in the three dimensional scanned data array.

3.4. Volumetric Scan

The volumetric scan consists to a full 3D scan over a specific area. This 3D scan is useful form multi Tx SAR measurement. Indeed, it is possible with OpenSAR to add, point by point, several volumetric scan to calculate the SAR value of the combined measurement as it is define in the standard IEEE1528 and IEC62209.

3.5. Power Drift

All SAR testing is under the EUT install full charged battery and transmit maximum output power. In OpenSAR measurement software, the power reference measurement and power drift measurement procedures are used for monitoring the power drift of EUT during SAR test. Both these procedures measure the field at a specified reference position before and after the SAR testing. The software will calculate the field difference in V/m. If the power drifts more than $\pm 5\%$, the SAR will be retested.

4. System Verification Procedure

4.1. Tissue Verification

The following tissue formulations are provided for reference only as some of the parameters have not been thoroughly verified. The composition of ingredients may be modified accordingly to achieve the desired target tissue parameters required for routine SAR evaluation.

Ingredients (% of weight)	Head Tissue									
	750	835	900	1800	1900	2000	2450	2600	5200	5800
Frequency Band (MHz)	750	835	900	1800	1900	2000	2450	2600	5200	5800
Water	34.40	34.40	34.40	55.36	55.36	57.87	57.87	57.87	65.53	65.53
NaCl	0.79	0.79	0.79	0.35	0.35	0.16	0.16	0.16	0.00	0.00
1,2-Propanediol	64.81	64.81	64.81	0.00	0.00	0.00	0.00	0.00	0.00	0.00
Triton X-100	0.00	0.00	0.00	30.45	30.45	19.97	19.97	19.97	24.24	24.24
DGBE	0.00	0.00	0.00	13.84	13.84	22.00	22.00	22.00	10.23	10.23

For SAR measurement of the field distribution inside the phantom, the phantom must be filled with homogeneous tissue simulating liquid to a depth of at least 15 cm. For head SAR testing, the liquid depth from the ear reference point (ERP) of the phantom to the liquid top surface is larger than 15 cm.

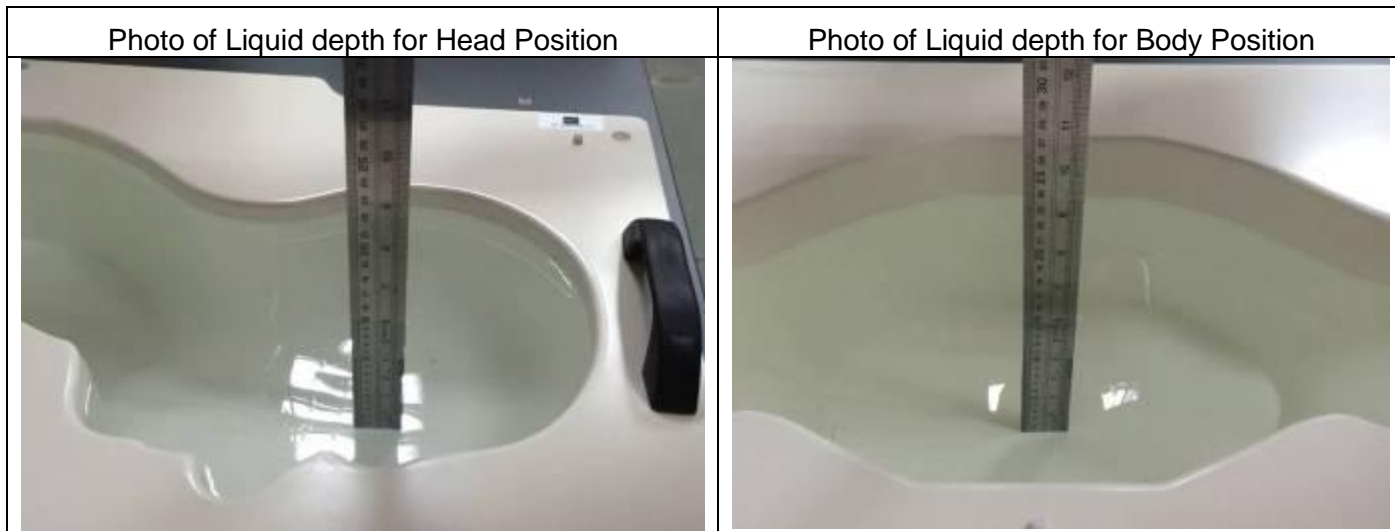

4.1.1. Tissue Dielectric Parameter Check Results

The simulating liquids should be checked at the beginning of a series of SAR measurements to determine of the dielectric parameter are within the tolerances of the specified target values. The measured conductivity and relative permittivity should be within $\pm 5\%$ of the target values.

Tissue Type	Measured Frequency (MHz)	Target Tissue		Measured Tissue		Liquid Temp.	Test Date
		ϵ_r ($\pm 5\%$)	σ (S/m) ($\pm 5\%$)	ϵ_r	σ (S/m)		
Head 750	750	41.96 (39.86~44.06)	0.89 (0.85~0.93)	41.03	0.90	21.7 °C	Mar. 16, 2024
Head 850	835	41.50 (39.43~43.58)	0.90 (0.86~0.95)	41.29	0.90	21.5 °C	Mar. 01, 2024
Head 1800	1800	40.00 (38.00~42.00)	1.40 (1.33~1.47)	39.20	1.39	21.6 °C	Feb. 29, 2024
Head 1900	1900	40.00 (38.00~42.00)	1.40 (1.33~1.47)	38.90	1.45	21.9 °C	Mar. 02, 2024
Head 2450	2450	39.20 (37.24~41.16)	1.80 (1.71~1.89)	37.72	1.76	21.8 °C	Mar. 09, 2024
Head 2600	2600	39.01 (37.06~40.96)	1.96 (1.86~2.06)	38.78	1.96	21.9 °C	Mar. 08, 2024
Head 3700	3700	37.70 (35.82~39.59)	3.12 (2.97~3.27)	37.13	2.99	21.4 °C	Mar. 17, 2024
Head 5200	5200	36.00 (34.20~37.80)	4.66 (4.43~4.89)	34.77	4.54	21.7 °C	Mar. 10, 2024
Head 5400	5400	35.80 (34.01~37.59)	4.86 (4.62~5.10)	34.62	4.87	21.8 °C	Mar. 14, 2024
Head 5600	5600	35.50 (33.73~37.28)	5.07 (4.82~5.32)	34.69	5.00	21.2 °C	Mar. 15, 2024
Head 5800	5800	35.30 (33.54~37.07)	5.27 (5.01~5.53)	34.20	5.24	21.3 °C	Mar. 11, 2024

NOTE: The dielectric parameters of the tissue-equivalent liquid should be measured under similar ambient conditions and within 2 °C of the conditions expected during the SAR evaluation to satisfy protocol requirements.

4.2. System Verification Procedure

The system verification is performed for verifying the accuracy of the complete measurement system and performance of the software. The dipole is connected to the signal source consisting of signal generator and amplifier via a directional coupler, N-connector cable and adaption to SMA. It is fed with a power of 100mW (below 5GHz) or 100mW (above 5GHz). To adjust this power a power meter is used. The power sensor is connected to the cable before the system verification to measure the power at this point and do adjustments at the signal generator. At the outputs of the directional coupler both return loss as well as forward power are controlled during the system verification to make sure that emitted power at the dipole is kept constant. This can also be checked by the power drift measurement after the test (result on plot).

The system verification is shown as below picture:

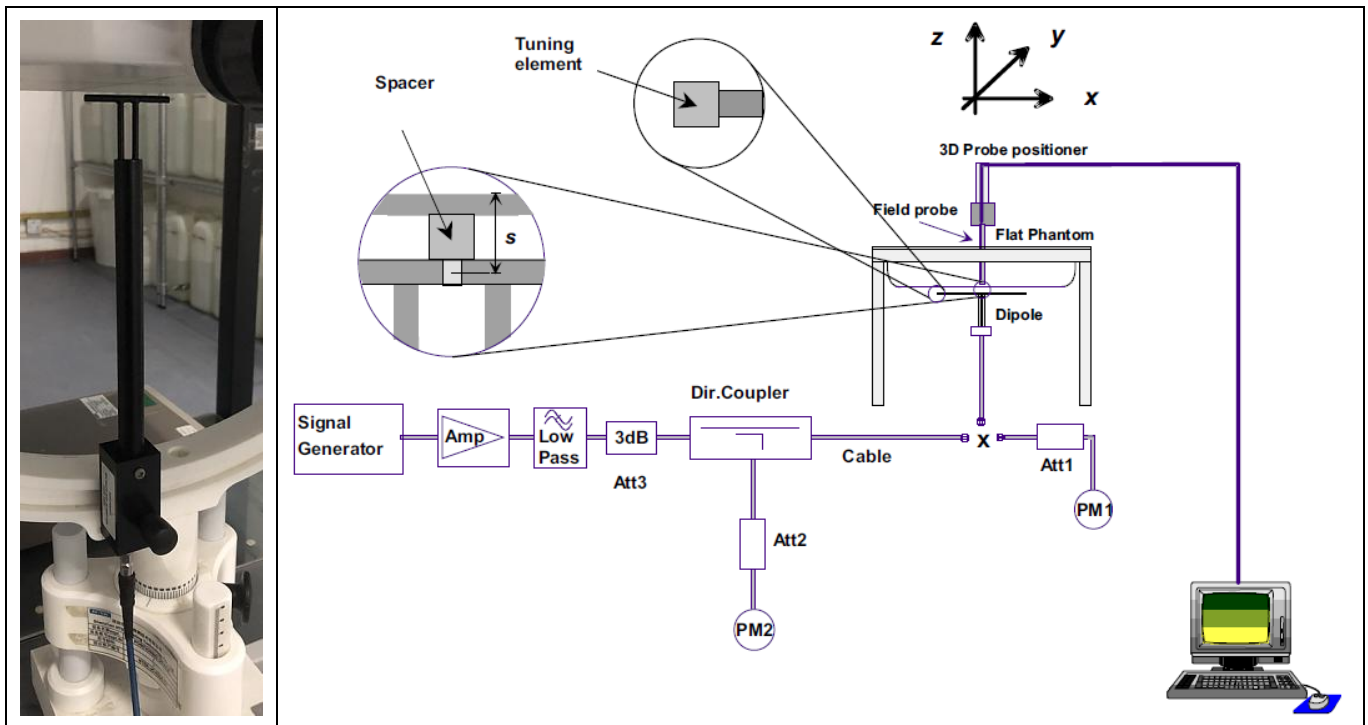

4.2.1. System Verification Results

Comparing to the original SAR value provided by SATIMO, the verification data should be within its specification of $\pm 10\%$. Below table shows the target SAR and measured SAR after normalized to 1W input power. The table below indicates the system performance verification can meet the variation criterion and the plots can be referred to Appendix B of this report.

System Verification	Target SAR (1W)		Measured SAR		Liquid Temp.	Test Date
	$(\pm 10\%)$		(Normalized to 1W)			
	1-g (W/Kg)	10-g (W/Kg)	1-g (W/Kg)	10-g (W/Kg)		
750MHz	8.60 (7.74~9.46)	5.78 (5.20~6.36)	9.08	6.03	21.7 °C	Mar. 16, 2024
835MHz	9.40 (8.46~10.34)	6.28 (5.65~6.91)	9.61	6.75	21.5 °C	Mar. 01, 2024
1800MHz	37.06 (33.35~40.77)	20.01 (18.01~22.01)	35.23	21.18	21.6 °C	Feb. 29, 2024
1900MHz	39.69 (35.72~43.66)	20.92 (18.83~23.01)	40.93	21.49	21.9 °C	Mar. 02, 2024
2450MHz	50.05 (45.05~55.06)	23.80 (21.42~26.18)	50.91	24.91	21.8 °C	Mar. 09, 2024
2600MHz	54.16 (48.74~59.58)	24.85 (22.37~27.34)	57.09	22.78	21.9 °C	Mar. 08, 2024
3700MHz	66.30 (59.67~72.93)	24.16 (22.96~26.57)	65.29	23.38	21.4 °C	Mar. 17, 2024
5200MHz	162.59 (146.33~178.85)	56.21 (50.59~61.83)	167.65	60.61	21.7 °C	Mar. 10, 2024
5400MHz	159.81 (143.83~175.79)	55.00 (49.50~60.50)	162.33	55.46	21.8 °C	Mar. 14, 2024
5600MHz	179.15 (161.24~197.07)	61.01 (54.91~67.11)	171.08	56.44	21.2 °C	Mar. 15, 2024
5800MHz	182.20 (163.98~200.42)	61.32 (55.19~67.45)	166.72	55.81	21.3 °C	Mar. 11, 2024

5. SAR Measurement variability and uncertainty

5.1. SAR measurement variability

Per KDB865664 D01 SAR measurement 100 MHz to 6 GHz, SAR measurement variability must be assessed for each frequency band, which is determined by the SAR probe calibration point and tissue-equivalent medium used for the device measurements. The additional measurements are repeated after the completion of all measurements requiring the same head or body tissue-equivalent medium in a frequency band. The test device should be returned to ambient conditions (normal room temperature) with the battery fully charged before it is re-mounted on the device holder for the repeated measurement(s) to minimize any unexpected variations in the repeated results.

- 1) Repeated measurement is not required when the original highest measured SAR is < 0.80 W/kg; steps 2) through 4) do not apply.
- 2) When the original highest measured SAR is ≥ 0.80 W/kg, repeat that measurement once.
- 3) Perform a second repeated measurement only if the ratio of largest to smallest SAR for the original and first repeated measurements is > 1.20 or when the original or repeated measurement is ≥ 1.45 W/kg (~ 10% from the 1-g SAR limit).
- 4) Perform a third repeated measurement only if the original, first or second repeated measurement is ≥ 1.5 W/kg and the ratio of largest to smallest SAR for the original, first and second repeated measurements is > 1.20 .

5.2. SAR measurement uncertainty

Per KDB865664 D01 SAR Measurement 100 MHz to 6 GHz, when the highest measured 1-g SAR within a frequency band is < 1.5 W/kg, the extensive SAR measurement uncertainty analysis described in IEEE Std 1528-2013 is not required in SAR reports submitted for equipment approval. The equivalent ratio (1.5/1.6) is applied to extremity and occupational exposure conditions.

6. RF Exposure Positions

6.1. Ear and handset reference point

Figure 6.1.1 shows the front, back, and side views of the SAM phantom. The center-of-mouth reference point is labeled “M”, the left ear reference point (ERP) is marked “LE”, and the right ERP is marked “RE”.



Fig 6.1.1 Front, back, and side views of SAM phantom

6.2. Definition of the cheek position

1. Define two imaginary lines on the handset, the vertical centerline and the horizontal line. The vertical centerline passes through two points on the front side of the handset: the midpoint of the width w_t of the handset at the level of the acoustic output (point A in Figure 6.2.1 and Figure 6.2.2), and the midpoint of the width w_b of the bottom of the handset (point B). The horizontal line is perpendicular to the vertical centerline and passes through the center of the acoustic output (see Figure 6.2.1). The two lines intersect at point A. Note that for many handsets, point A coincides with the center of the acoustic output; however, the acoustic output may be located elsewhere on the horizontal line. Also note that the vertical centerline is not necessarily parallel to the front face of the handset (see Figure 6.2.2), especially for clamshell handsets, handsets with flip covers, and other irregularly-shaped handsets.
2. Position the handset close to the surface of the phantom such that point A is on the (virtual) extension of the line passing through points RE and LE on the phantom (see Figure 6.2.3), such that the plane defined by the vertical centerline and the horizontal line of the handset is approximately parallel to the sagittal plane of the phantom.
3. Translate the handset towards the phantom along the line passing through RE and LE until handset point A touches the pinna at the ERP
4. While maintaining the handset in this plane, rotate it around the LE-RE line until the vertical centerline is in the plane normal to the plane containing B-M and N-F lines, i.e., the Reference Plane.
5. Rotate the handset around the vertical centerline until the handset (horizontal line) is parallel to the N-F line.

6. While maintaining the vertical centerline in the Reference Plane, keeping point A on the line passing through RE and LE, and maintaining the handset contact with the pinna, rotate the handset about the N-F line until any point on the handset is in contact with a phantom point below the pinna on the cheek. See Figure 6.2.3. The actual rotation angles should be documented in the test report.

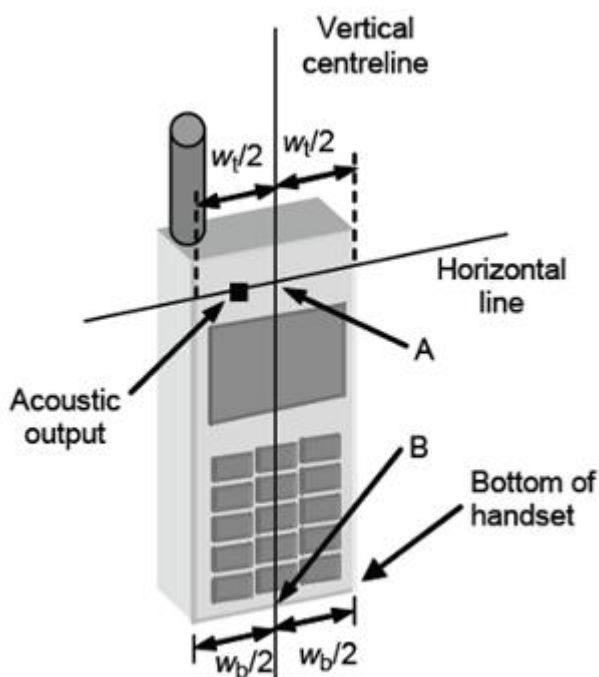

Fig 6.2.1 Handset vertical and horizontal reference lines—"fixed case"

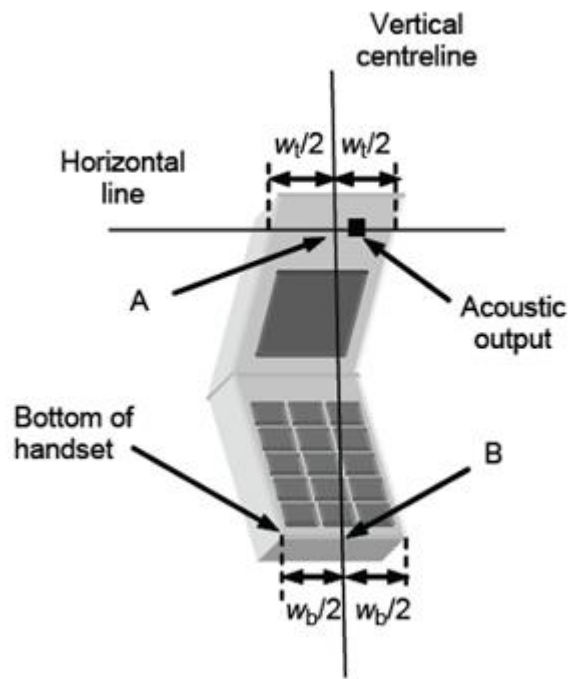

Fig 6.2.2 Handset vertical and horizontal reference lines—"clam-shell case"

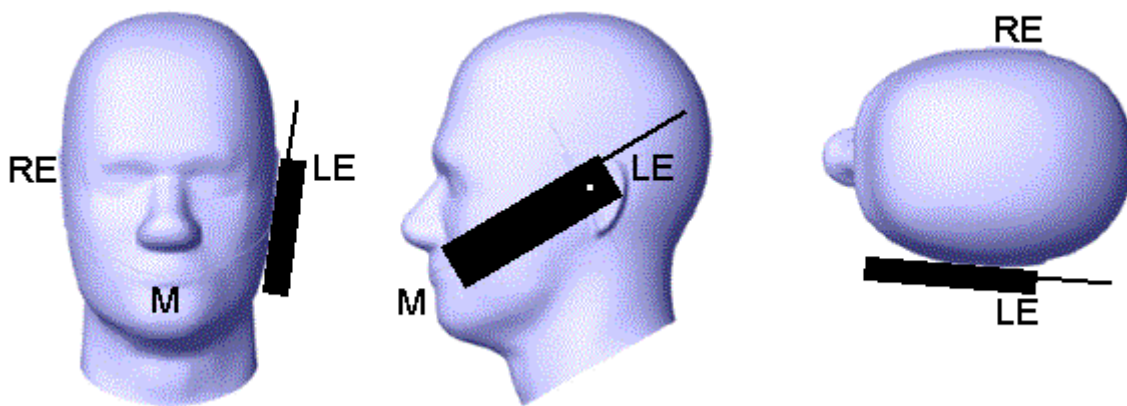

Fig 6.2.3 cheek or touch position. The reference points for the right ear (RE), left ear (LE), and mouth (M), which establish the Reference Plane for handset positioning, are indicated.

6.3. Definition of the tilt position

1. While maintaining the orientation of the handset, retract the handset parallel to the reference plane far enough away from the phantom to enable a rotation of the device by 15 degree.
2. Rotate the Handset around the horizontal line by 15 degree (see Figure 6.3.1).
3. While maintaining the orientation of the handset, move the handset towards the phantom on a line passing through RE and LE until any part of the handset touches the ear. The tilt position is obtained when the contact is on the pinna. If the contact is at any location other than the pinna, e.g., the antenna with the back of the phantom head, the angle of the handset shall be reduced. In this case, the tilt position is obtained if any part of the handset is in contact with the pinna as well as a second part of the handset is in contact with the phantom, e.g., the antenna with the back of the head.

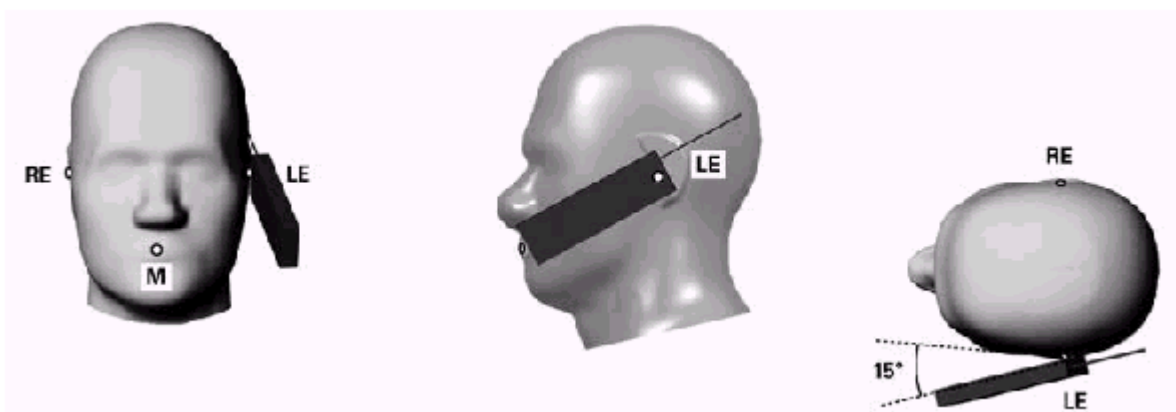

Figure 6.3.1 – Tilt position of the wireless device on the left side of SAM

6.4. Body Worn Accessory

1. Body-worn operating configurations are tested with the belt-clips and holsters attached to the device and positioned against a flat phantom in a normal use configuration (see Figure 6.4.1). Per KDB 648474 D04, body-worn accessory exposure is typically related to voice mode operations when handsets are carried in body-worn accessories. The body-worn accessory procedures in FCC KDB 447498 D01 should be used to test for body-worn accessory SAR compliance, without a headset connected to it. This enables the test results for such configuration to be compatible with that required for hotspot mode when the body-worn accessory test separation distance is greater than or equal to that required for hotspot mode, when applicable. When the reported SAR for body-worn accessory, measured without a headset connected to the handset is $< 1.2 \text{ W/kg}$, the highest reported SAR configuration for that wireless mode and frequency band should be repeated for that body-worn accessory with a handset attached to the handset.
2. Accessories for body-worn operation configurations are divided into two categories: those that do not contain metallic components and those that do contain metallic components and those that do contain metallic components. When multiple accessories that do not contain metallic components are supplied with the device, the device is tested with only the accessory that dictates the closest

spacing to the body. Then multiple accessories that contain metallic components are tested with the device with each accessory. If multiple accessories share an identical metallic component (i.e. the same metallic belt-clip used with different holsters with no other metallic components) only the accessory that dictates the closest spacing to the body is tested.

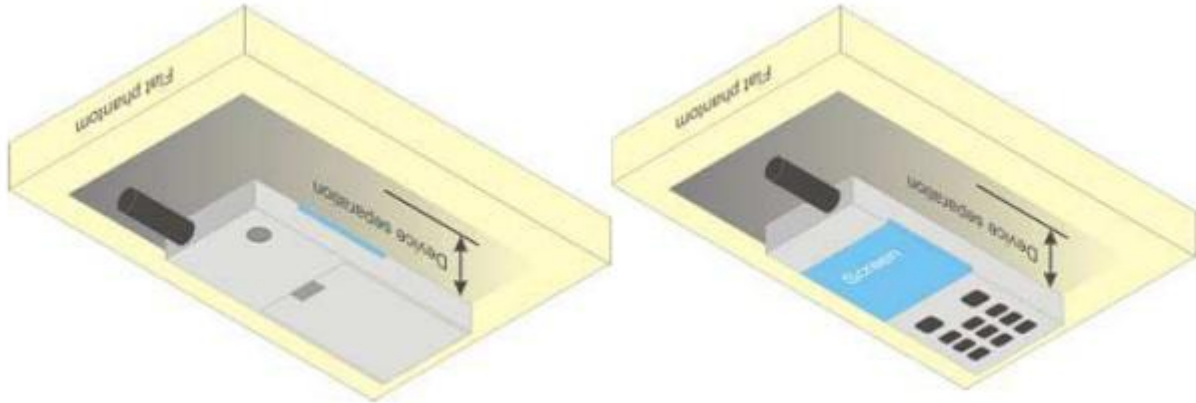

Figure 6.4.1 – Test positions for body-worn devices

6.5. Wireless Router Devices

Some battery-operated handsets have the capability to transmit and receive user through simultaneous transmission of WLAN simultaneously with a separate licensed transmitter. The FCC has provided guidance in FCC KDB Publication 941225 D06 where SAR test considerations for handsets ($L \times W \geq 9 \text{ cm} \times 5 \text{ cm}$) are based on a composite test separation distance of 10mm from the front, back and edges of the device containing transmitting antennas within 2.5cm of their edges, determined from general mixed use conditions for this type of devices. Since the hotspot SAR results may overlap with the body-worn accessory SAR requirements, the more conservative configurations can be considered, thus excluding some body-worn accessory SAR tests.

When the user enables the personal wireless router functions for the handset, actual operations include simultaneous transmission of both the WLAN transmitter and another licensed transmitter. Both transmitters often do not transmit at the same transmitting frequency and thus cannot be evaluated for SAR under actual use conditions due to the limitations of the SAR assessment probes. Therefore, SAR must be evaluated for each frequency transmission and mode separately and spatially summed with the WLAN transmitter according to FCC KDB Publication 447498 D01 publication procedures. The “Portable Hotspot” feature on the handset was NOT activated during SAR assessments, to ensure the SAR measurements were evaluated for a single transmission frequency RF signal at a time.

7. RF Output Power

7.1. GSM Conducted Power

Band GSM850	Burst-Averaged output Power (dBm)				Frame-Averaged output Power (dBm)			
Tx Channel	Tune-up (dBm)	128	189	251	Tune-up (dBm)	128	189	251
Frequency (MHz)		824.2	836.4	848.8		824.2	836.4	848.8
GSM (GMSK)	33.50	33.07	33.20	32.89	24.47	24.04	24.17	23.86
GPRS(GMSK,1 Tx slot)	33.50	33.09	33.22	32.88	24.47	24.06	24.19	23.85
GPRS(GMSK,2 Tx slot)	32.50	32.36	32.49	32.16	26.48	26.34	26.47	26.14
GPRS(GMSK,3 Tx slot)	31.00	30.66	30.78	30.47	26.74	26.40	26.52	26.21
GPRS(GMSK,4 Tx slot)	30.00	29.56	29.73	29.43	26.99	26.55	26.72	26.42
EGPRS(8PSK,1 Tx slot)	27.00	26.91	26.80	26.73	17.97	17.88	17.77	17.70
EGPRS(8PSK,2 Tx slot)	26.50	26.36	26.07	25.98	20.48	20.34	20.05	19.96
EGPRS(8PSK,3 Tx slot)	24.00	23.69	23.78	23.59	19.74	19.43	19.52	19.33
EGPRS(8PSK,4 Tx slot)	23.00	22.63	22.07	22.54	19.99	19.62	19.06	19.53
Band GSM1900	Burst-Averaged output Power (dBm)				Frame-Averaged output Power (dBm)			
Tx Channel	Tune-up (dBm)	512	661	810	Tune-up (dBm)	512	661	810
Frequency (MHz)		1850.2	1880	1909.8		1850.2	1880	1909.8
GSM (GMSK)	31.00	30.58	30.30	30.43	21.97	21.55	21.27	21.40
GPRS(GMSK,1 Tx slot)	31.00	30.59	30.29	30.43	21.97	21.56	21.26	21.40
GPRS(GMSK,2 Tx slot)	30.00	29.86	29.59	29.74	23.98	23.84	23.57	23.72
GPRS(GMSK,3 Tx slot)	28.50	28.04	27.82	28.00	24.24	23.78	23.56	23.74
GPRS(GMSK,4 Tx slot)	27.00	26.96	26.74	26.98	23.99	23.95	23.73	23.97
EGPRS(8PSK,1 Tx slot)	27.50	26.64	27.04	26.82	18.47	17.61	18.01	17.79
EGPRS(8PSK,2 Tx slot)	26.00	25.43	25.57	25.64	19.98	19.41	19.55	19.62
EGPRS(8PSK,3 Tx slot)	24.00	23.50	24.00	23.31	19.74	19.24	19.74	19.05
EGPRS(8PSK,4 Tx slot)	22.50	22.00	22.26	22.10	19.49	18.99	19.25	19.09

7.2. WCDMA Conducted Power

WCDMA Band 2	Burst-Averaged output Power (dBm)			
Tx Channel	Tune-up (dBm)	9262	9400	9538
Frequency (MHz)		1852.4	1880	1907.6
RMC12.2K	24.00	23.90	23.99	23.80
HSDPA Sub 1	23.00	22.88	22.97	22.83
HSDPA Sub 2	22.50	22.27	22.46	22.42

HSDPA Sub 3	21.50	21.13	21.09	21.20
HSDPA Sub 4	21.50	21.24	21.45	21.27
HSUPA Sub 1	23.00	22.01	22.78	22.52
HSUPA Sub 2	23.00	22.75	22.81	22.62
HSUPA Sub 3	22.00	21.01	21.62	21.35
HSUPA Sub 4	23.00	22.84	22.93	22.74
HSUPA Sub 5	22.50	21.51	22.22	22.07
WCDMA Band 4	Burst-Averaged output Power (dBm)			
Tx Channel	Tune-up (dBm)	1312	1413	1513
Frequency (MHz)		1712.4	1732.6	1752.6
RMC12.2K	24.00	23.73	23.66	23.73
HSDPA Sub 1	23.00	22.76	22.66	22.72
HSDPA Sub 2	22.50	22.27	21.99	22.32
HSDPA Sub 3	21.50	21.08	21.33	21.14
HSDPA Sub 4	21.50	21.31	20.93	21.34
HSUPA Sub 1	23.00	21.72	22.44	22.57
HSUPA Sub 2	23.00	22.62	22.56	22.58
HSUPA Sub 3	21.50	21.00	21.36	21.39
HSUPA Sub 4	23.00	22.72	22.64	22.67
HSUPA Sub 5	22.00	21.36	21.77	21.96
WCDMA Band 5	Burst-Averaged output Power (dBm)			
Tx Channel	Tune-up (dBm)	4132	4182	4233
Frequency (MHz)		826.4	836.4	846.6
RMC12.2K	24.00	23.63	23.66	23.49
HSDPA Sub 1	23.00	22.67	22.68	22.49
HSDPA Sub 2	22.50	22.21	22.23	21.87
HSDPA Sub 3	21.50	21.04	20.86	20.68
HSDPA Sub 4	21.50	21.22	20.88	20.68
HSUPA Sub 1	22.50	21.96	22.48	22.32
HSUPA Sub 2	23.00	22.62	22.57	22.36
HSUPA Sub 3	21.50	20.88	21.43	21.13
HSUPA Sub 4	23.00	22.66	22.69	22.48
HSUPA Sub 5	22.50	21.09	22.01	21.86

7.3. LTE Conducted Power

Band	Band Width	Modulation	RB Configuration		Tune-up (dBm)	Channel/Frequency(MHz)		
			RB Size	RB Offset		18607/1850.7	18900/1880	19193/1909.3
LTE Band 2	1.4MHz	QPSK	1	0	23.50	23.08	23.15	23.20
			1	2	23.50	23.11	23.13	23.20
			1	5	23.50	23.04	23.13	23.19
			3	0	23.50	23.10	23.15	23.23
			3	1	23.50	23.08	23.15	23.22
			3	2	23.50	23.07	23.13	23.22
		16QAM	6	0	22.50	22.08	22.18	22.24
			1	0	23.00	22.24	22.40	22.52
			1	2	23.00	22.41	22.37	22.43
			1	5	23.00	22.38	22.38	22.44
			3	0	22.50	22.07	22.12	22.22
			3	1	22.50	22.09	22.15	22.20
			3	2	22.50	21.98	22.09	22.19
			6	0	21.50	21.08	21.23	21.27
Band	Band Width	Modulation	RB Configuration		Tune-up (dBm)	Channel/Frequency(MHz)		
			RB Size	RB Offset		18615/1851.5	18900/1880	19185/1908.5
LTE Band 2	3MHz	QPSK	1	0	23.50	23.02	23.13	23.12
			1	7	23.50	23.01	23.09	23.17
			1	14	23.50	23.02	23.06	23.19
			8	0	22.50	22.02	22.13	22.16
			8	4	22.50	21.98	22.12	22.21
			8	7	22.50	22.01	22.05	22.21
			15	0	22.50	22.05	22.10	22.19
		16QAM	1	0	23.00	22.29	22.44	22.35
			1	7	23.00	22.34	22.31	22.48
			1	14	23.00	22.28	22.36	22.50
			8	0	21.50	21.08	21.17	21.19
			8	4	21.50	21.11	21.13	21.29
			8	7	21.50	21.08	21.13	21.29
			15	0	21.50	21.07	21.16	21.17
Band	Band	Modulation	RB		Tune-up	Channel/Frequency(MHz)		

	Width	Configuration	Configuration		(dBm)			
			RB Size	RB Offset		18625/1852.5	18900/1880	19175/1907.5
LTE Band 2	5MHz	QPSK	1	0	23.50	23.10	23.22	23.17
			1	12	23.50	23.03	23.14	23.15
			1	24	23.50	23.01	23.12	23.26
			12	0	22.50	22.04	22.23	22.23
			12	6	22.50	22.02	22.13	22.21
			12	11	22.50	22.03	22.04	22.25
			25	0	22.50	22.06	22.17	22.25
		16QAM	1	0	23.00	22.31	22.44	22.34
			1	12	23.00	22.32	22.39	22.42
			1	24	23.00	22.31	22.36	22.61
			12	0	21.50	20.97	21.22	21.21
			12	6	21.50	20.98	21.13	21.15
			12	11	21.50	21.02	21.09	21.22
			25	0	21.50	21.06	21.16	21.27
Band	Band Width	Modulation	RB Configuration		Tune-up (dBm)	Channel/Frequency(MHz)		
			RB Size	RB Offset		18650/1855	18900/1880	19150/1905
LTE Band 2	10MHz	QPSK	1	0	23.50	23.09	23.17	23.11
			1	24	23.50	22.96	23.17	23.14
			1	49	23.50	22.93	23.01	23.24
			25	0	22.50	21.88	22.24	22.35
			25	12	22.50	21.96	22.18	22.17
			25	24	22.50	22.07	22.14	22.22
			50	0	22.50	22.04	22.15	22.32
		16QAM	1	0	23.00	22.32	22.35	22.29
			1	24	23.00	22.25	22.37	22.34
			1	49	23.00	22.10	22.18	22.51
			25	0	21.50	20.88	21.21	21.36
			25	12	21.50	20.98	21.15	21.13
			25	24	21.50	21.10	21.15	21.24
			50	0	21.50	20.98	21.15	21.32
Band	Band Width	Modulation	RB Configuration		Tune-up (dBm)	Channel/Frequency(MHz)		
			RB Size	RB Offset		18675/1857.5	18900/1880	19125/1902.5
LTE	15MHz	QPSK	1	0	23.50	22.99	23.00	22.89

Band	Band Width	Modulation	RB Configuration		Tune-up (dBm)	Channel/Frequency(MHz)		
			RB Size	RB Offset		18700/1860	18900/1880	19100/1900
Band 2			1	37	23.50	22.92	23.13	23.08
			1	74	23.50	22.84	22.97	23.16
			36	0	22.50	21.84	22.14	22.16
			36	18	22.50	21.92	22.09	22.08
			36	37	22.50	22.01	22.12	22.06
			75	0	22.50	21.94	22.16	22.17
			75	0	22.50	21.94	22.16	22.17
		16QAM	1	0	22.50	22.24	22.23	22.03
			1	37	22.50	22.17	22.38	22.34
			1	74	22.50	22.00	22.16	22.38
			36	0	21.50	20.84	21.18	21.16
			36	18	21.50	20.91	21.09	21.07
			36	37	21.50	20.99	21.07	21.09
			75	0	21.50	20.92	21.15	21.21

Band	Band Width	Modulation	RB Configuration		Tune-up (dBm)	Channel/Frequency(MHz)		
			RB Size	RB Offset		19957/1710.7	20175/1732.5	20393/1754.3
LTE Band 4	1.4MHz	QPSK	1	0	23.00	22.94	22.78	22.81
			1	2	23.00	22.94	22.81	22.79
			1	5	23.00	22.91	22.84	22.76
			3	0	23.00	22.95	22.82	22.80

		16QAM	3	1	23.00	22.96	22.82	22.79
			3	2	23.00	22.94	22.82	22.80
			6	0	22.00	21.93	21.82	21.82
			1	0	22.50	22.21	22.03	21.97
			1	2	22.50	22.15	22.03	21.99
			1	5	22.50	22.11	22.04	22.13
			3	0	22.00	21.90	21.86	21.82
			3	1	22.00	21.93	21.77	21.84
			3	2	22.00	21.85	21.76	21.80
			6	0	21.00	20.96	20.90	20.84
Band	Band Width	Modulation	RB Configuration		Tune-up (dBm)	Channel/Frequency(MHz)		
			RB Size	RB Offset		19965/1711.5	20175/1732.5	20385/1753.5
LTE Band 4	3MHz	QPSK	1	0	23.00	22.92	22.81	22.76
			1	7	23.00	22.90	22.79	22.77
			1	14	23.00	22.89	22.80	22.79
			8	0	22.00	21.89	21.78	21.78
			8	4	22.00	21.85	21.76	21.76
			8	7	22.00	21.87	21.75	21.79
			15	0	22.00	21.89	21.78	21.81
		16QAM	1	0	22.50	22.13	22.15	22.11
			1	7	22.50	22.17	22.14	22.13
			1	14	22.50	22.17	22.12	21.95
			8	0	21.00	20.97	20.84	20.82
			8	4	21.00	20.95	20.84	20.86
			8	7	21.00	20.90	20.84	20.84
			15	0	21.00	20.92	20.78	20.78
Band	Band Width	Modulation	RB Configuration		Tune-up (dBm)	Channel/Frequency(MHz)		
			RB Size	RB Offset		19975/1712.5	20175/1732.5	20375/1752.5
LTE Band 4	5MHz	QPSK	1	0	23.00	23.00	22.89	22.84
			1	12	23.00	22.91	22.84	22.81
			1	24	23.00	22.97	22.88	22.86
			12	0	22.00	21.86	21.83	21.85
			12	6	22.00	21.93	21.81	21.83
			12	11	22.00	21.88	21.80	21.80
			25	0	22.00	21.88	21.87	21.87
		16QAM	1	0	22.50	22.32	22.09	22.19

Band	Band Width	Modulation	RB Configuration		Tune-up (dBm)	Channel/Frequency(MHz)		
			RB Size	RB Offset		20000/1715	20175/1732.5	20350/1750
			1	12	22.50	22.19	22.18	22.04
			1	24	22.50	22.25	22.09	22.05
			12	0	21.00	20.83	20.79	20.82
			12	6	21.00	20.90	20.80	20.79
			12	11	21.00	20.88	20.88	20.74
			25	0	21.00	20.89	20.83	20.81
LTE Band 4	10MHz	QPSK	1	0	23.50	23.01	22.81	22.87
			1	24	23.50	22.89	22.87	22.81
			1	49	23.50	22.82	22.90	22.84
			25	0	22.00	21.78	21.82	21.85
			25	12	22.00	21.88	21.86	21.81
			25	24	22.00	21.91	21.88	21.78
		16QAM	50	0	22.00	21.90	21.87	21.82
			1	0	22.50	22.31	22.14	22.25
			1	24	22.50	22.24	22.18	22.15
			1	49	22.50	22.12	22.18	22.18
			25	0	21.00	20.77	20.82	20.86
			25	12	21.00	20.89	20.82	20.82
			25	24	21.00	20.93	20.87	20.77
			50	0	21.00	20.84	20.81	20.82
			RB Configuration		Tune-up (dBm)	Channel/Frequency(MHz)		
			RB Size	RB Offset		20025/1717.5	20175/1732.5	20325/1747.5
LTE Band 4	15MHz	QPSK	1	0	23.00	22.87	22.70	22.80
			1	37	23.00	22.85	22.83	22.82
			1	74	23.00	22.73	22.83	22.83
			36	0	22.00	21.74	21.73	21.82
			36	18	22.00	21.83	21.79	21.78
			36	37	22.00	21.74	21.83	21.75
			75	0	22.00	21.80	21.84	21.81
		16QAM	1	0	22.50	22.16	22.03	22.09
			1	37	22.50	22.18	22.06	22.08
			1	74	22.50	21.93	22.11	22.03
			36	0	21.00	20.74	20.72	20.73
			36	18	21.00	20.79	20.79	20.78

Band	Band Width	Modulation	RB Configuration		Tune-up (dBm)	Channel/Frequency(MHz)		
			RB Size	RB Offset		20050/1720	20175/1732.5	20300/1745
						36	37	21.00
			75	0	21.00	20.70	20.80	20.81
LTE Band 4	20MHz	QPSK	1	0	23.00	22.88	22.64	22.77
			1	49	23.00	22.77	22.86	22.87
			1	99	23.00	22.81	22.87	22.77
			50	0	22.00	21.76	21.83	21.82
			50	24	22.00	21.81	21.83	21.86
			50	49	22.00	21.73	21.95	21.79
			100	0	22.00	21.75	21.89	21.80
		16QAM	1	0	22.50	22.16	21.92	21.96
			1	49	22.50	22.00	22.08	22.18
			1	99	22.50	22.14	22.12	21.98
			50	0	21.00	20.69	20.76	20.77
			50	24	21.00	20.83	20.85	20.84
			50	49	21.00	20.70	20.90	20.79
			100	0	21.00	20.64	20.82	20.74

Band	Band Width	Modulation	RB Configuration		Tune-up (dBm)	Channel/Frequency(MHz)		
			RB Size	RB Offset		20407/824.7	20525/836.5	20643/848.3
LTE Band 5	1.4MHz	QPSK	1	0	24.50	23.91	23.99	23.94
			1	2	24.50	23.91	24.03	23.92
			1	5	24.50	23.92	23.99	23.87
			3	0	24.50	24.02	24.06	23.99
			3	1	24.50	24.00	24.04	24.00
			3	2	24.50	23.99	24.02	23.96
			6	0	23.50	22.97	23.05	22.98
		16QAM	1	0	23.50	23.17	23.29	23.22
			1	2	23.50	23.10	23.34	23.11
			1	5	23.50	23.21	23.28	23.15
			3	0	23.50	23.04	23.14	23.01
			3	1	23.50	23.01	23.07	23.06
			3	2	23.50	23.01	23.11	23.05
			6	0	22.50	22.07	22.14	22.06
Band	Band	Modulation	RB		Tune-up	Channel/Frequency(MHz)		

	Width		Configuration		(dBm)			
			RB Size	RB Offset		20415/825.5	20525/836.5	20635/847.5
LTE Band 5	3MHz	QPSK	1	0	24.50	23.97	23.97	24.04
			1	7	24.50	23.89	24.05	23.98
			1	14	24.50	23.90	24.04	23.93
			8	0	23.50	22.98	23.02	23.07
			8	4	23.50	22.95	23.02	23.01
			8	7	23.50	22.94	23.04	22.96
			15	0	23.50	22.96	23.06	23.03
		16QAM	1	0	23.50	23.21	23.22	23.28
			1	7	23.50	23.18	23.20	23.24
			1	14	23.50	23.04	23.24	23.05
			8	0	22.50	22.03	22.08	22.12
			8	4	22.50	22.04	22.12	22.10
			8	7	22.50	22.02	22.10	22.06
			15	0	22.50	22.01	22.10	22.07
Band	Band Width	Modulation	RB Configuration		Tune-up (dBm)	Channel/Frequency(MHz)		
			RB Size	RB Offset		20425/826.5	20525/836.5	20625/846.5
LTE Band 5	5MHz	QPSK	1	0	24.50	24.00	24.02	24.08
			1	12	24.50	23.93	24.06	24.04
			1	24	24.50	23.96	24.09	23.95
			12	0	23.50	23.00	23.07	23.14
			12	6	23.50	23.00	23.11	23.03
			12	11	23.50	23.02	23.06	23.04
			25	0	23.50	23.02	23.04	23.09
		16QAM	1	0	23.50	23.22	23.13	23.30
			1	12	23.50	23.08	23.28	23.20
			1	24	23.50	23.19	23.38	23.13
			12	0	22.50	21.99	22.08	22.09
			12	6	22.50	21.98	22.07	22.07
			12	11	22.50	21.97	22.07	22.01
			25	0	22.50	22.05	22.09	22.12
Band	Band Width	Modulation	RB Configuration		Tune-up (dBm)	Channel/Frequency(MHz)		
			RB Size	RB Offset		20450/829	20525/836.5	20600/844
LTE	10MHz	QPSK	1	0	24.50	23.98	23.99	24.06

Band 5		1	24	24.50	23.95	24.06	24.08
		1	49	24.50	23.98	24.06	23.95
		25	0	23.50	22.98	23.02	23.19
		25	12	23.50	22.99	23.02	23.09
		25	24	23.50	23.03	23.04	23.08
		50	0	23.50	23.05	23.07	23.15
	16QAM	1	0	23.50	23.16	23.24	23.33
		1	24	23.50	23.14	23.34	23.35
		1	49	23.50	23.22	23.18	23.14
		25	0	22.50	22.05	22.07	22.23
		25	12	22.50	22.00	22.06	22.14
		25	24	22.50	22.07	22.07	22.07
		50	0	22.50	21.98	22.06	22.14

Band	Band Width	Modulation	RB Configuration		Tune-up (dBm)	Channel/Frequency(MHz)		
			RB Size	RB Offset		20775/2502.5	21100/2535	21425/2567.5
LTE Band 7	5MHz	QPSK	1	0	24.50	23.11	24.10	23.83
			1	12	24.50	23.21	24.12	23.69
			1	24	24.50	23.31	24.14	23.59
			12	0	23.50	22.13	23.17	22.84
			12	6	23.50	22.18	23.13	22.73
			12	11	23.50	22.22	23.15	22.63
		16QAM	1	0	23.50	22.23	23.26	23.03
			1	12	23.50	22.39	23.28	22.95
			1	24	23.50	22.54	23.37	22.79
			12	0	22.50	21.05	22.19	21.84
			12	6	22.50	21.10	22.12	21.70
			12	11	22.50	21.20	22.14	21.59
			25	0	22.50	21.21	22.19	21.73

Band	Band Width	Modulation	RB Configuration		Tune-up (dBm)	Channel/Frequency(MHz)		
			RB Size	RB Offset		20800/2505	21100/2535	21400/2565
LTE Band 7	10MHz	QPSK	1	0	24.50	23.05	24.03	23.95
			1	24	24.50	23.27	24.15	23.82
			1	49	24.50	23.42	24.06	23.57
			25	0	23.50	22.08	23.11	22.93

			25	12	23.50	22.26	23.11	22.80
			25	24	23.50	22.37	23.09	22.68
			50	0	23.50	22.30	23.08	22.87
		16QAM	1	0	23.50	22.24	23.33	23.16
			1	24	23.50	22.58	23.32	22.97
			1	49	23.50	22.67	23.27	22.84
			25	0	22.50	21.14	22.12	21.96
			25	12	22.50	21.33	22.20	21.83
			25	24	22.50	21.36	22.13	21.71
			50	0	22.50	21.28	22.13	21.84
Band	Band Width	Modulation	RB Configuration		Tune-up (dBm)	Channel/Frequency(MHz)		
			RB Size	RB Offset		20825/2507.5	21100/2535	21375/2562.5
LTE Band 7	15MHz	QPSK	1	0	24.50	23.03	23.91	23.84
			1	37	24.50	23.34	24.15	23.87
			1	74	24.50	23.43	23.96	23.50
			36	0	23.50	22.20	23.07	22.92
			36	18	23.50	22.33	23.10	22.88
			36	37	23.50	22.50	23.03	22.73
			75	0	23.50	22.40	23.07	22.86
		16QAM	1	0	23.50	22.30	23.18	23.04
			1	37	23.50	22.58	23.42	23.11
			1	74	23.50	22.73	23.16	22.76
			36	0	22.50	21.21	22.02	21.95
			36	18	22.50	21.34	22.01	21.84
			36	37	22.50	21.43	22.10	21.74
			75	0	22.50	21.32	22.06	21.81
Band	Band Width	Modulation	RB Configuration		Tune-up (dBm)	Channel/Frequency(MHz)		
			RB Size	RB Offset		20850/2510	21100/2535	21350/2560
LTE Band 7	20MHz	QPSK	1	0	24.50	22.98	23.73	23.82
			1	49	24.50	23.46	24.11	23.91
			1	99	24.50	23.44	23.87	23.51
			50	0	23.50	22.30	23.05	22.98
			50	24	23.50	22.45	23.07	22.91
			50	49	23.50	22.48	23.11	22.78
			100	0	23.50	22.36	23.06	22.91
		16QAM	1	0	23.50	22.27	23.04	23.14

			1	49	23.50	22.77	23.33	23.10
			1	99	23.50	22.73	23.06	22.71
			50	0	22.50	21.22	21.97	21.98
			50	24	22.50	21.43	22.06	21.91
			50	49	22.50	21.46	22.10	21.78
			100	0	22.50	21.40	22.03	21.89

Band	Band Width	Modulation	RB Configuration		Tune-up (dBm)	Channel/Frequency(MHz)		
			RB Size	RB Offset		23017/699.7	23095/707.5	23173/715.3
LTE Band 12	1.4MHz	QPSK	1	0	24.50	24.20	24.16	23.96
			1	2	24.50	24.18	24.10	23.93
			1	5	24.50	24.24	24.12	23.95
			3	0	24.50	24.22	24.23	24.05
			3	1	24.50	24.23	24.16	24.05
			3	2	24.50	24.23	24.20	24.02
			6	0	23.50	23.22	23.20	23.02
		16QAM	1	0	23.50	23.36	23.44	23.09
			1	2	23.50	23.37	23.39	23.19
			1	5	23.50	23.30	23.39	23.17
			3	0	23.50	23.24	23.30	23.14
			3	1	23.50	23.27	23.29	23.15
			3	2	23.50	23.27	23.28	23.06
			6	0	22.50	22.22	22.31	22.12

Band	Band Width	Modulation	RB Configuration		Tune-up (dBm)	Channel/Frequency(MHz)		
			RB Size	RB Offset		23025/700.5	23095/707.5	23165/714.5
LTE Band 12	3MHz	QPSK	1	0	24.50	24.10	24.17	24.00
			1	7	24.50	24.14	24.13	23.95
			1	14	24.50	24.12	24.07	23.95
			8	0	23.50	23.11	23.17	23.06
			8	4	23.50	23.19	23.20	23.01
			8	7	23.50	23.13	23.13	23.00
			15	0	23.50	23.15	23.17	23.05
		16QAM	1	0	23.50	23.25	23.39	23.21
			1	7	23.50	23.36	23.42	23.05
			1	14	23.50	23.36	23.32	23.12
			8	0	22.50	22.20	22.28	22.16

Band	Band Width	Modulation	RB Configuration		Tune-up (dBm)	Channel/Frequency(MHz)		
			RB Size	RB Offset		23035/701.5	23095/707.5	23155/713.5
			8	4	22.50	22.28	22.27	22.13
			8	7	22.50	22.25	22.22	22.12
			15	0	22.50	22.20	22.21	22.14
LTE Band 12	5MHz	QPSK	1	0	24.50	24.15	24.23	24.06
			1	12	24.50	24.17	24.15	24.01
			1	24	24.50	24.22	24.10	23.98
			12	0	23.50	23.16	23.27	23.12
			12	6	23.50	23.21	23.26	23.08
			12	11	23.50	23.20	23.23	23.00
		16QAM	25	0	23.50	23.14	23.19	23.04
			1	0	23.50	23.34	23.39	23.22
			1	12	23.50	23.31	23.43	23.17
			1	24	23.50	23.42	23.29	23.17
			12	0	22.50	22.14	22.28	22.09
			12	6	22.50	22.19	22.21	22.07
			12	11	22.50	22.22	22.19	21.97
			25	0	22.50	22.17	22.25	22.10
Band	Band Width	Modulation	RB Configuration		Tune-up (dBm)	Channel/Frequency(MHz)		
			RB Size	RB Offset		23060/704	23095/707.5	23130/711
LTE Band 12	10MHz	QPSK	1	0	24.50	24.17	24.24	24.23
			1	24	24.50	24.21	24.20	24.07
			1	49	24.50	24.11	24.03	23.95
			25	0	23.50	23.21	23.28	23.13
			25	12	23.50	23.22	23.19	23.12
			25	24	23.50	23.20	23.22	22.99
			50	0	23.50	23.25	23.27	23.11
		16QAM	1	0	24.00	23.33	23.50	23.49
			1	24	24.00	23.47	23.37	23.15
			1	49	24.00	23.36	23.25	23.16
			25	0	22.50	22.28	22.34	22.16
			25	12	22.50	22.25	22.24	22.14
			25	24	22.50	22.23	22.25	22.08
			50	0	22.50	22.24	22.30	22.09

Band	Band Width	Modulation	RB Configuration		Tune-up (dBm)	Channel/Frequency(MHz)		
			RB Size	RB Offset		23205/779.5	23230/782	23255/784.5
LTE Band 13	5MHz	QPSK	1	0	24.00	23.76	23.75	23.77
			1	12	24.00	23.69	23.72	23.75
			1	24	24.00	23.77	23.72	23.71
			12	0	23.00	22.83	22.85	22.82
			12	6	23.00	22.83	22.85	22.77
			12	11	23.00	22.81	22.83	22.80
			25	0	23.00	22.80	22.81	22.78
		16QAM	1	0	23.50	22.94	22.85	23.03
			1	12	23.50	22.91	22.93	23.01
			1	24	23.50	22.95	22.93	22.89
			12	0	22.00	21.77	21.86	21.79
			12	6	22.00	21.82	21.81	21.75
			12	11	22.00	21.78	21.81	21.79
			25	0	22.00	21.86	21.85	21.80

Band	Band Width	Modulation	RB Configuration		Tune-up (dBm)	Channel/Frequency(MHz)		
			RB Size	RB Offset		/	23230/782	/

LTE Band 13	10MHz	QPSK	1	0	24.00	/	23.79	/
			1	24	24.00	/	23.76	/
			1	49	24.00	/	23.67	/
			25	0	23.00	/	22.82	/
			25	12	23.00	/	22.80	/
			25	24	23.00	/	22.85	/
			50	0	23.00	/	22.85	/
		16QAM	1	0	23.50	/	23.01	/
			1	24	23.50	/	22.92	/
			1	49	23.50	/	22.85	/
			25	0	22.00	/	21.89	/
			25	12	22.00	/	21.85	/
			25	24	22.00	/	21.87	/
			50	0	22.00	/	21.89	/

Band	Band Width	Modulation	RB Configuration		Tune-up (dBm)	Channel/Frequency(MHz)		
			RB	RB		23755/706.5	23790/710	23825/713.5

Band	Band Width	Modulation	RB Configuration		Tune-up (dBm)	Channel/Frequency(MHz)		
			RB Size	RB Offset		23780/709	23790/710	23800/711
LTE Band 17	5MHz	QPSK	1	0	24.50	24.29	24.15	24.08
			1	12	24.50	24.25	24.12	23.98
			1	24	24.50	24.25	24.02	23.98
			12	0	23.50	23.24	23.15	23.16
			12	6	23.50	23.19	23.22	23.12
			12	11	23.50	23.21	23.15	22.98
			25	0	23.50	23.23	23.12	23.04
		16QAM	1	0	23.50	23.40	23.31	23.31
			1	12	23.50	23.32	23.25	23.12
			1	24	23.50	23.31	23.15	23.22
			12	0	22.50	22.24	22.10	22.12
			12	6	22.50	22.17	22.16	22.10
			12	11	22.50	22.19	22.14	22.00
			25	0	22.50	22.24	22.17	22.12

Band	Band Width	Modulation	RB Configuration		Tune-up (dBm)	Channel/Frequency(MHz)		
			RB Size	RB Offset		23875/817.5	23925/822.5	23975/827.5
LTE Band	5MHz	QPSK	1	0	23.50	22.98	23.14	23.09
			1	12	23.50	22.94	23.11	23.09

18			1	24	23.50	22.98	23.09	23.05
			12	0	22.50	21.98	22.06	22.12
			12	6	22.50	21.95	22.03	22.09
			12	11	22.50	22.01	22.09	22.12
			25	0	22.50	22.02	22.09	22.13
		16QAM	1	0	22.50	22.29	22.49	22.46
			1	12	22.50	22.24	22.28	22.27
			1	24	22.50	22.33	22.46	22.37
			12	0	21.50	21.03	21.07	21.14
			12	6	21.50	20.97	21.07	21.11
			12	11	21.50	21.02	21.07	21.12
			25	0	21.50	20.99	21.08	21.14
			Band	Band Width	Modulation	RB Configuration		Tune-up (dBm)
RB Size	RB Offset	23900/820				23925/822.5	23950/825	
LTE Band 18	10MHz	QPSK	1	0	23.50	23.11	23.13	23.15
			1	24	23.50	23.03	22.99	23.04
			1	49	23.50	23.11	23.09	23.12
			25	0	22.50	22.07	22.06	22.07
			25	12	22.50	22.03	22.04	22.04
			25	24	22.50	22.03	22.04	22.10
			50	0	22.50	22.08	22.06	22.10
		16QAM	1	0	23.00	22.43	22.41	22.50
			1	24	23.00	22.37	22.27	22.34
			1	49	23.00	22.35	22.39	22.26
			25	0	21.50	21.07	21.07	21.07
			25	12	21.50	21.01	21.03	21.06
			25	24	21.50	21.06	21.06	21.12
Band	Band Width	Modulation	RB Configuration		Tune-up (dBm)	Channel/Frequency(MHz)		
			RB Size	RB Offset		/	23925/822.5	/
LTE Band 18	15MHz	QPSK	1	0	23.50	/	23.14	/
			1	37	23.50	/	23.07	/
			1	74	23.50	/	23.04	/
			36	0	22.50	/	22.05	/
			36	18	22.50	/	22.08	/
			36	37	22.50	/	22.12	/

	16QAM	75	0	22.50	/	22.09	/
		1	0	22.50	/	22.47	/
		1	37	22.50	/	22.43	/
		1	74	22.50	/	22.34	/
		36	0	21.50	/	21.07	/
		36	18	21.50	/	21.04	/
		36	37	21.50	/	21.13	/
		75	0	21.50	/	21.10	/

Band	Band Width	Modulation	RB Configuration		Tune-up (dBm)	Channel/Frequency(MHz)		
			RB Size	RB Offset		24025/832.5	24075/837.5	24125/842.5
LTE Band 19	5MHz	QPSK	1	0	23.50	23.07	23.17	23.07
			1	12	23.50	23.03	23.07	23.01
			1	24	23.50	23.18	23.07	23.02
			12	0	22.50	22.13	22.13	22.06
			12	6	22.50	22.12	22.09	22.01
			12	11	22.50	22.10	22.04	22.02
			25	0	22.50	22.14	22.13	22.03
		16QAM	1	0	22.50	22.44	22.44	22.43
			1	12	22.50	22.30	22.42	22.36
			1	24	22.50	22.35	22.44	22.29
			12	0	21.50	21.13	21.18	21.09
			12	6	21.50	21.13	21.10	21.03
			12	11	21.50	21.12	21.05	21.04
			25	0	21.50	21.13	21.11	21.03

Band	Band Width	Modulation	RB Configuration		Tune-up (dBm)	Channel/Frequency(MHz)		
			RB Size	RB Offset		24050/835	24075/837.5	24100/840
LTE Band 19	10MHz	QPSK	1	0	23.50	23.13	23.07	23.24
			1	24	23.50	23.08	23.08	23.04
			1	49	23.50	23.13	23.10	23.03
			25	0	22.50	22.06	22.10	22.13
			25	12	22.50	22.09	22.06	22.01
			25	24	22.50	22.06	22.03	22.02
			50	0	22.50	22.08	22.07	22.07
		16QAM	1	0	23.00	22.50	22.44	22.49
			1	24	23.00	22.37	22.30	22.30

Band	Band Width	Modulation	RB Configuration		Tune-up (dBm)	Channel/Frequency(MHz)		
			RB Size	RB Offset		/	24075/837.5	/
			1	49	23.00	22.48	22.36	22.36
			25	0	21.50	21.06	21.11	21.11
			25	12	21.50	21.11	21.08	21.02
			25	24	21.50	21.07	21.03	21.02
			50	0	21.50	21.07	21.09	21.07
LTE Band 19	15MHz	QPSK	1	0	23.50	/	23.13	/
			1	37	23.50	/	23.11	/
			1	74	23.50	/	23.02	/
			36	0	22.50	/	22.13	/
			36	18	22.50	/	22.08	/
			36	37	22.50	/	22.03	/
		16QAM	75	0	22.50	/	22.10	/
			1	0	22.50	/	22.43	/
			1	37	22.50	/	22.48	/
			1	74	22.50	/	22.21	/
			36	0	21.50	/	21.12	/
			36	18	21.50	/	21.10	/
			36	37	21.50	/	21.05	/
			75	0	21.50	/	21.10	/

Band	Band Width	Modulation	RB Configuration		Tune-up (dBm)	Channel/Frequency(MHz)		
			RB Size	RB Offset		26047/1850.7	26365/1882.5	26683/1914.3
LTE Band 25	1.4MHz	QPSK	1	0	23.50	23.11	23.08	23.04
			1	2	23.50	23.12	23.10	23.00
			1	5	23.50	23.06	23.07	23.03
			3	0	23.50	23.20	23.06	23.04
			3	1	23.50	23.10	23.02	23.03
			3	2	23.50	23.17	23.03	23.00
		16QAM	6	0	22.50	22.11	22.04	22.03
			1	0	22.50	22.35	22.42	22.17
			1	2	22.50	22.38	22.34	22.33
			1	5	22.50	22.33	22.30	22.29
			3	0	22.50	22.12	22.08	21.98
			3	1	22.50	22.09	22.00	21.96

			3	2	22.50	22.08	22.05	21.97
			6	0	21.50	21.17	21.15	21.16
Band	Band Width	Modulation	RB Configuration		Tune-up (dBm)	Channel/Frequency(MHz)		
			RB Size	RB Offset		26055/1851.5	26365/1882.5	26675/1913.5
LTE Band 25	3MHz	QPSK	1	0	23.50	23.10	23.01	23.00
			1	7	23.50	23.09	23.04	22.99
			1	14	23.50	23.12	23.07	23.00
			8	0	22.50	22.06	22.09	22.10
			8	4	22.50	22.10	22.06	22.02
			8	7	22.50	22.08	22.08	22.08
		16QAM	1	0	22.50	22.32	22.24	22.34
			1	7	22.50	22.33	22.32	22.16
			1	14	22.50	22.26	22.28	22.25
			8	0	21.50	21.16	21.11	21.17
			8	4	21.50	21.17	21.13	21.15
			8	7	21.50	21.21	21.15	21.10
			15	0	21.50	21.12	21.11	21.10
Band	Band Width	Modulation	RB Configuration		Tune-up (dBm)	Channel/Frequency(MHz)		
			RB Size	RB Offset		26065/1852.5	26365/1882.5	26665/1912.5
LTE Band 25	5MHz	QPSK	1	0	23.50	23.20	23.08	23.07
			1	12	23.50	23.13	23.14	23.04
			1	24	23.50	23.14	23.10	23.06
			12	0	22.50	22.18	22.07	22.18
			12	6	22.50	22.16	22.11	22.12
			12	11	22.50	22.15	22.10	22.10
			25	0	22.50	22.18	22.11	22.14
		16QAM	1	0	22.50	22.33	22.36	22.35
			1	12	22.50	22.38	22.38	22.23
			1	24	22.50	22.39	22.37	22.36
			12	0	21.50	21.15	21.14	21.23
			12	6	21.50	21.17	21.14	21.10
			12	11	21.50	21.13	21.11	21.12
			25	0	21.50	21.17	21.13	21.15
Band	Band Width	Modulation	RB Configuration		Tune-up (dBm)	Channel/Frequency(MHz)		
			RB Size	RB Offset				

Band	Band Width	Modulation	RB Configuration		Tune-up (dBm)	Channel/Frequency(MHz)		
			RB Size	RB Offset		26115/1857.5	26365/1882.5	26615/1907.5
LTE Band 25	10MHz	QPSK	1	0	23.50	26090/1855	26365/1882.5	26640/1910
			1	24	23.50	23.20	23.08	23.12
			1	49	23.50	23.04	23.13	23.06
			25	0	22.50	23.12	23.10	23.11
			25	12	22.50	22.20	22.09	22.10
			25	24	22.50	22.11	22.12	22.10
			50	0	22.50	22.12	22.11	22.06
		16QAM	1	0	22.50	22.40	22.37	22.43
			1	24	22.50	22.36	22.42	22.36
			1	49	22.50	22.32	22.41	22.39
			25	0	21.50	21.19	21.09	21.10
			25	12	21.50	21.12	21.09	21.13
			25	24	21.50	21.14	21.12	21.05
			50	0	21.50	21.16	21.10	21.06
LTE Band 25	15MHz	QPSK	1	0	23.50	26115/1857.5	26365/1882.5	26615/1907.5
			1	37	23.50	23.21	23.10	23.15
			1	74	23.50	23.12	23.14	23.08
			36	0	22.50	23.05	23.14	23.08
			36	18	22.50	22.16	22.11	22.11
			36	37	22.50	22.11	22.13	22.11
			75	0	22.50	22.11	22.12	22.06
		16QAM	1	0	22.50	22.16	22.12	22.09
			1	37	22.50	22.48	22.44	22.41
			1	74	22.50	22.39	22.40	22.31
			36	0	21.50	22.37	22.36	22.42
			36	18	21.50	21.16	21.11	21.09
			36	37	21.50	21.11	21.09	21.09
			75	0	21.50	21.09	21.12	21.05
LTE Band	20MHz	QPSK	1	0	23.50	26140/1860	26365/1882.5	26590/1905
			1	49	23.50	23.14	23.12	23.16
			1	49	23.50	23.08	23.16	23.12

25		1	99	23.50	23.15	23.08	23.14
		50	0	22.50	22.21	22.13	22.16
		50	24	22.50	22.17	22.16	22.16
		50	49	22.50	22.15	22.14	22.11
		100	0	22.50	22.16	22.12	22.14
	16QAM	1	0	22.50	22.44	22.48	22.44
		1	49	22.50	22.37	22.39	22.48
		1	99	22.50	22.48	22.33	22.38
		50	0	21.50	21.22	21.14	21.16
		50	24	21.50	21.17	21.13	21.15
		50	49	21.50	21.14	21.12	21.13
		100	0	21.50	21.15	21.11	21.13

Band	Band Width	Modulation	RB Configuration		Tune-up (dBm)	Channel/Frequency(MHz)		
			RB Size	RB Offset		37775/2572.5	38000/2595	38225/2617.5
LTE Band 38	5MHz	QPSK	1	0	25.00	24.63	23.55	22.58
			1	12	25.00	24.60	23.51	22.48
			1	24	25.00	24.50	23.54	22.48
			12	0	24.00	23.56	22.64	21.59
			12	6	24.00	23.48	22.59	21.55
			12	11	24.00	23.40	22.62	21.52
			25	0	23.50	23.47	22.62	21.56
		16QAM	1	0	24.00	23.61	22.74	21.77
			1	12	24.00	23.58	22.73	21.69
			1	24	24.00	23.48	22.74	21.69
			12	0	23.00	22.55	21.67	20.63
			12	6	23.00	22.46	21.61	20.59
			12	11	23.00	22.42	21.65	20.53
			25	0	23.00	22.53	21.70	20.64
Band	Band Width	Modulation	RB Configuration		Tune-up (dBm)	Channel/Frequency(MHz)		
			RB Size	RB Offset		37800/2575	38000/2595	38200/2615
LTE Band 38	10MHz	QPSK	1	0	24.50	24.38	23.52	22.85
			1	24	24.50	24.26	23.53	22.57
			1	49	24.50	23.96	23.47	22.44
			25	0	23.50	23.45	22.60	21.70
			25	12	23.50	23.35	22.63	21.61

		16QAM	25	24	23.50	23.24	22.59	21.57
			50	0	23.50	23.38	22.61	21.66
			1	0	24.00	23.61	22.80	22.10
			1	24	24.00	23.48	22.77	21.80
			1	49	24.00	23.19	22.70	21.68
			25	0	23.00	22.51	21.70	20.78
			25	12	23.00	22.43	21.68	20.69
			25	24	23.00	22.30	21.65	20.64
			50	0	22.50	22.44	21.66	20.70
Band	Band Width	Modulation	RB Configuration		Tune-up (dBm)	Channel/Frequency(MHz)		
			RB Size	RB Offset		37825/2577.5	38000/2595	38175/2612.5
LTE Band 38	15MHz	QPSK	1	0	24.50	24.33	23.52	23.16
			1	37	24.50	24.09	23.51	22.67
			1	74	24.50	23.62	23.34	22.37
			36	0	23.50	23.40	22.64	22.02
			36	18	23.50	23.24	22.64	21.76
			36	37	23.50	23.05	22.60	21.58
			75	0	23.50	23.25	22.60	21.84
		16QAM	1	0	24.00	23.57	22.79	22.42
			1	37	24.00	23.33	22.76	21.91
			1	74	24.00	22.85	22.59	21.61
			36	0	22.50	22.39	21.62	21.04
			36	18	22.50	22.23	21.63	20.77
			36	37	22.50	22.04	21.61	20.62
			75	0	22.50	22.28	21.62	20.78
Band	Band Width	Modulation	RB Configuration		Tune-up (dBm)	Channel/Frequency(MHz)		
			RB Size	RB Offset		37850/2580	38000/2595	38150/2610
LTE Band 38	20MHz	QPSK	1	0	24.50	24.33	23.57	23.44
			1	49	24.50	23.94	23.52	22.87
			1	99	24.50	23.42	23.18	22.33
			50	0	23.50	23.38	22.57	22.28
			50	24	23.50	23.15	22.63	22.01
			50	49	23.50	22.89	22.58	21.69
			100	0	23.50	23.12	22.56	21.98
		16QAM	1	0	24.00	23.54	22.82	22.68
			1	49	24.00	23.20	22.75	22.10

			1	99	24.00	22.67	22.42	21.58
			50	0	22.50	22.44	21.61	21.34
			50	24	22.50	22.19	21.65	21.03
			50	49	22.50	21.93	21.61	20.78
			100	0	22.50	22.16	21.59	21.00

Band	Band Width	Modulation	RB Configuration		Tune-up (dBm)	Channel/Frequency(MHz)		
			RB Size	RB Offset		39675/2498.5	40620/2593	41565/2687.5
LTE Band 41	5MHz	QPSK	1	0	26.00	25.43	25.98	26.00
			1	12	26.00	25.36	25.97	25.94
			1	24	26.00	25.38	25.94	26.00
			12	0	25.00	24.39	23.76	25.00
			12	6	25.00	24.34	23.02	24.97
			12	11	25.00	24.34	24.88	24.94
		16QAM	25	0	25.00	24.39	24.93	24.97
			1	0	25.50	24.62	25.14	25.16
			1	12	25.50	24.57	25.15	25.11
			1	24	25.50	24.56	25.12	25.17
			12	0	24.50	23.43	24.00	24.03
			12	6	24.50	23.36	23.91	23.97
			12	11	24.50	23.37	23.91	23.98
			25	0	24.50	23.42	23.99	24.02

Band	Band Width	Modulation	RB Configuration		Tune-up (dBm)	Channel/Frequency(MHz)		
			RB Size	RB Offset		39700/2501	40620/2593	41540/2685
LTE Band 41	10MHz	QPSK	1	0	26.00	25.40	25.93	25.99
			1	24	26.00	25.83	26.00	25.98
			1	49	26.00	25.36	25.85	25.95
			25	0	25.00	24.35	24.96	24.97
			25	12	25.00	24.36	24.96	24.98
			25	24	25.00	24.37	24.92	24.95
			50	0	25.50	24.43	24.98	25.02
		16QAM	1	0	25.50	24.64	25.15	25.20
			1	24	25.50	24.58	25.18	25.17
			1	49	25.50	24.61	25.05	25.14
			25	0	24.50	23.40	24.03	24.04
			25	12	24.50	23.38	23.98	24.04

Band	Band Width	Modulation	RB Configuration		Tune-up (dBm)	Channel/Frequency(MHz)		
			RB Size	RB Offset		39725/2503.5	40620/2593	41515/2682.5
			25	24	24.50	23.40	23.73	24.00
			50	0	24.50	23.42	23.99	24.06
LTE Band 41	15MHz	QPSK	1	0	26.00	25.38	25.83	25.83
			1	37	26.00	25.36	25.97	25.86
			1	74	26.00	25.36	25.74	25.78
			36	0	25.00	24.37	24.93	24.88
			36	18	25.00	24.37	24.93	24.86
			36	37	25.00	24.35	24.84	24.86
			75	0	25.00	24.40	24.91	24.88
		16QAM	1	0	25.50	24.60	25.05	23.54
			1	37	25.50	24.57	25.17	25.06
			1	74	25.50	24.02	24.95	24.98
			36	0	24.00	23.33	23.92	23.90
			36	18	24.00	23.33	23.92	23.84
			36	37	24.00	23.35	23.86	23.88
			75	0	24.00	23.40	23.90	23.90
Band	Band Width	Modulation	RB Configuration		Tune-up (dBm)	Channel/Frequency(MHz)		
			RB Size	RB Offset		39750/2506	40620/2593	41490/2680
LTE Band 41	20MHz	QPSK	1	0	26.00	25.36	25.81	25.82
			1	49	26.00	25.37	25.99	25.87
			1	99	26.00	25.24	25.65	25.74
			50	0	25.00	24.39	23.10	24.94
			50	24	25.00	24.42	24.99	24.93
			50	49	25.00	24.39	24.88	24.88
			100	0	25.00	24.39	24.92	24.91
		16QAM	1	0	25.50	24.56	25.01	25.01
			1	49	25.50	24.58	25.19	25.05
			1	99	25.50	24.45	24.85	24.95
			50	0	24.50	23.41	24.01	23.98
			50	24	24.50	23.43	24.00	23.96
			50	49	24.50	23.41	23.91	23.91
			100	0	24.00	23.42	23.94	23.92

Band	Band Width	Modulation	RB Configuration		Tune-up (dBm)	Channel/Frequency(MHz)	
			RB Size	RB Offset		40140/2545	41140/2645
LTE Band 41	20MHz	QPSK	1	0	26.00	25.42	25.70
			1	49	26.00	25.20	25.78
			1	99	26.00	25.21	25.70
			50	0	25.00	24.32	24.90
			50	24	25.00	24.40	24.87
			50	49	25.00	24.35	24.81
		16QAM	100	0	25.00	24.31	24.86
			1	0	25.50	24.50	24.90
			1	49	25.50	24.48	24.93
			1	99	25.50	24.43	24.86
			50	0	24.50	23.37	23.84
			50	24	24.50	23.40	23.90
			50	49	24.50	23.36	23.82
			100	0	24.00	23.38	23.83

7.4. NR SA Power

Band	SCS (kHz)	Bandwidth (MHz)	UL Channel	RB Allocation	Modulation	Tune-up	Power (dBm)
n38	30	10	515000	1@1	DFT_BPSK	24.50	24.23
n38	30	10	515000	24@0	DFT_QPSK	24.50	23.17
n38	30	10	515000	12@6	DFT_QPSK	24.50	24.20
n38	30	10	515000	1@1	DFT_QPSK	24.50	24.49
n38	30	10	515000	1@22	DFT_QPSK	24.50	24.17
n38	30	10	515000	1@1	DFT_QAM16	24.50	23.32
n38	30	10	515000	1@1	DFT_QAM64	22.00	21.91
n38	30	10	515000	1@1	DFT_QAM256	21.00	20.05
n38	30	10	515000	1@1	CP_QPSK	24.50	23.48
n38	30	10	519000	1@1	DFT_BPSK	24.50	23.28
n38	30	10	519000	24@0	DFT_QPSK	23.00	22.38
n38	30	10	519000	12@6	DFT_QPSK	24.50	23.42
n38	30	10	519000	1@1	DFT_QPSK	24.50	23.54
n38	30	10	519000	1@22	DFT_QPSK	24.50	23.48
n38	30	10	519000	1@1	DFT_QAM16	23.00	22.33
n38	30	10	519000	1@1	DFT_QAM64	21.00	20.94

n38	30	10	519000	1@1	DFT_QAM256	20.00	19.10
n38	30	10	519000	1@1	CP_QPSK	23.00	22.55
n38	30	10	523000	1@1	DFT_BPSK	23.00	22.70
n38	30	10	523000	24@0	DFT_QPSK	22.00	21.72
n38	30	10	523000	12@6	DFT_QPSK	23.00	22.71
n38	30	10	523000	1@1	DFT_QPSK	23.00	22.91
n38	30	10	523000	1@22	DFT_QPSK	23.00	22.74
n38	30	10	523000	1@1	DFT_QAM16	22.00	21.71
n38	30	10	523000	1@1	DFT_QAM64	21.00	20.34
n38	30	10	523000	1@1	DFT_QAM256	19.00	18.50
n38	30	10	523000	1@1	CP_QPSK	22.00	21.85
n38	30	15	515500	1@1	DFT_BPSK	24.50	24.19
n38	30	15	515500	36@0	DFT_QPSK	24.50	23.09
n38	30	15	515500	18@9	DFT_QPSK	24.50	24.08
n38	30	15	515500	1@1	DFT_QPSK	24.50	24.49
n38	30	15	515500	1@36	DFT_QPSK	24.50	23.83
n38	30	15	515500	1@1	DFT_QAM16	24.50	23.27
n38	30	15	515500	1@1	DFT_QAM64	22.00	21.86
n38	30	15	515500	1@1	DFT_QAM256	20.00	19.98
n38	30	15	515500	1@1	CP_QPSK	24.50	23.34
n38	30	15	519000	1@1	DFT_BPSK	24.50	23.32
n38	30	15	519000	36@0	DFT_QPSK	23.00	22.38
n38	30	15	519000	18@9	DFT_QPSK	24.50	23.42
n38	30	15	519000	1@1	DFT_QPSK	24.50	23.69
n38	30	15	519000	1@36	DFT_QPSK	24.50	23.46
n38	30	15	519000	1@1	DFT_QAM16	23.00	22.39
n38	30	15	519000	1@1	DFT_QAM64	21.00	20.94
n38	30	15	519000	1@1	DFT_QAM256	20.00	19.14
n38	30	15	519000	1@1	CP_QPSK	23.00	22.58
n38	30	15	522500	1@1	DFT_BPSK	23.00	22.90
n38	30	15	522500	36@0	DFT_QPSK	22.00	21.85
n38	30	15	522500	18@9	DFT_QPSK	23.00	22.78
n38	30	15	522500	1@1	DFT_QPSK	24.50	23.15
n38	30	15	522500	1@36	DFT_QPSK	23.00	22.70
n38	30	15	522500	1@1	DFT_QAM16	22.00	21.93
n38	30	15	522500	1@1	DFT_QAM64	21.00	20.53
n38	30	15	522500	1@1	DFT_QAM256	19.00	18.67
n38	30	15	522500	1@1	CP_QPSK	23.00	22.08
n38	30	20	516000	1@1	DFT_BPSK	24.50	24.14

n38	30	20	516000	50@0	DFT_QPSK	23.00	22.94
n38	30	20	516000	25@12	DFT_QPSK	24.50	23.97
n38	30	20	516000	1@1	DFT_QPSK	24.50	24.41
n38	30	20	516000	1@49	DFT_QPSK	24.50	23.62
n38	30	20	516000	1@1	DFT_QAM16	24.50	23.23
n38	30	20	516000	1@1	DFT_QAM64	22.00	21.81
n38	30	20	516000	1@1	DFT_QAM256	20.00	19.95
n38	30	20	516000	1@1	CP_QPSK	24.50	23.28
n38	30	20	519000	1@1	DFT_BPSK	24.50	23.38
n38	30	20	519000	50@0	DFT_QPSK	23.00	22.38
n38	30	20	519000	25@12	DFT_QPSK	24.50	23.45
n38	30	20	519000	1@1	DFT_QPSK	24.50	23.64
n38	30	20	519000	1@49	DFT_QPSK	24.50	23.33
n38	30	20	519000	1@1	DFT_QAM16	23.00	22.42
n38	30	20	519000	1@1	DFT_QAM64	22.00	21.01
n38	30	20	519000	1@1	DFT_QAM256	20.00	19.14
n38	30	20	519000	1@1	CP_QPSK	23.00	22.49
n38	30	20	522000	1@1	DFT_BPSK	24.50	23.08
n38	30	20	522000	50@0	DFT_QPSK	22.00	21.92
n38	30	20	522000	25@12	DFT_QPSK	23.00	22.98
n38	30	20	522000	1@1	DFT_QPSK	24.50	23.31
n38	30	20	522000	1@49	DFT_QPSK	23.00	22.69
n38	30	20	522000	1@1	DFT_QAM16	23.00	22.09
n38	30	20	522000	1@1	DFT_QAM64	21.00	20.74
n38	30	20	522000	1@1	DFT_QAM256	19.00	18.84
n38	30	20	522000	1@1	CP_QPSK	23.00	22.20
n38	30	30	517000	1@1	DFT_BPSK	24.50	23.91
n38	30	30	517000	75@0	DFT_QPSK	23.00	22.69
n38	30	30	517000	36@18	DFT_QPSK	24.50	23.75
n38	30	30	517000	1@1	DFT_QPSK	24.50	24.22
n38	30	30	517000	1@76	DFT_QPSK	24.50	23.34
n38	30	30	517000	1@1	DFT_QAM16	23.00	22.93
n38	30	30	517000	1@1	DFT_QAM64	22.00	21.60
n38	30	30	517000	1@1	DFT_QAM256	20.00	19.76
n38	30	30	517000	1@1	CP_QPSK	23.00	22.92
n38	30	30	519000	1@1	DFT_BPSK	24.50	23.36
n38	30	30	519000	75@0	DFT_QPSK	23.00	22.26
n38	30	30	519000	36@18	DFT_QPSK	24.50	23.39
n38	30	30	519000	1@1	DFT_QPSK	24.50	23.67

n38	30	30	519000	1@76	DFT_QPSK	23.00	22.95
n38	30	30	519000	1@1	DFT_QAM16	23.00	22.37
n38	30	30	519000	1@1	DFT_QAM64	22.00	21.04
n38	30	30	519000	1@1	DFT_QAM256	20.00	19.18
n38	30	30	519000	1@1	CP_QPSK	23.00	22.38
n38	30	30	521000	1@1	DFT_BPSK	23.00	22.97
n38	30	30	521000	75@0	DFT_QPSK	22.00	21.98
n38	30	30	521000	36@18	DFT_QPSK	24.50	23.14
n38	30	30	521000	1@1	DFT_QPSK	24.50	23.21
n38	30	30	521000	1@76	DFT_QPSK	23.00	22.49
n38	30	30	521000	1@1	DFT_QAM16	22.00	21.97
n38	30	30	521000	1@1	DFT_QAM64	21.00	20.66
n38	30	30	521000	1@1	DFT_QAM256	19.00	18.76
n38	30	30	521000	1@1	CP_QPSK	22.00	21.95
n38	30	40	518000	1@1	DFT_BPSK	24.50	23.72
n38	30	40	518000	100@0	DFT_QPSK	23.00	22.46
n38	30	40	518000	50@25	DFT_QPSK	24.50	23.48
n38	30	40	518000	1@1	DFT_QPSK	24.50	23.98
n38	30	40	518000	1@104	DFT_QPSK	23.00	22.78
n38	30	40	518000	1@1	DFT_QAM16	23.00	22.79
n38	30	40	518000	1@1	DFT_QAM64	22.00	21.56
n38	30	40	518000	1@1	DFT_QAM256	20.00	19.60
n38	30	40	518000	1@1	CP_QPSK	23.00	22.59
n38	30	40	519000	1@1	DFT_BPSK	24.50	23.50
n38	30	40	519000	100@0	DFT_QPSK	23.00	22.21
n38	30	40	519000	50@25	DFT_QPSK	24.50	23.35
n38	30	40	519000	1@1	DFT_QPSK	24.50	23.75
n38	30	40	519000	1@104	DFT_QPSK	23.00	22.53
n38	30	40	519000	1@1	DFT_QAM16	23.00	22.56
n38	30	40	519000	1@1	DFT_QAM64	22.00	21.34
n38	30	40	519000	1@1	DFT_QAM256	20.00	19.36
n38	30	40	519000	1@1	CP_QPSK	23.00	22.45
n38	30	40	520000	1@1	DFT_BPSK	24.50	23.16
n38	30	40	520000	100@0	DFT_QPSK	23.00	22.02
n38	30	40	520000	50@25	DFT_QPSK	24.50	23.22
n38	30	40	520000	1@1	DFT_QPSK	24.50	23.35
n38	30	40	520000	1@104	DFT_QPSK	23.00	22.33
n38	30	40	520000	1@1	DFT_QAM16	23.00	22.23
n38	30	40	520000	1@1	DFT_QAM64	22.00	21.14

n38	30	40	520000	1@1	DFT_QAM256	20.00	19.04
n38	30	40	520000	1@1	CP_QPSK	23.00	22.03
n77(3700-3980)	30	10	647000	1@1	DFT_BPSK	26.50	26.09
n77(3700-3980)	30	10	647000	24@0	DFT_QPSK	26.50	25.23
n77(3700-3980)	30	10	647000	12@6	DFT_QPSK	26.50	26.23
n77(3700-3980)	30	10	647000	1@1	DFT_QPSK	26.50	26.08
n77(3700-3980)	30	10	647000	1@22	DFT_QPSK	26.50	26.11
n77(3700-3980)	30	10	647000	1@1	DFT_QAM16	26.50	25.22
n77(3700-3980)	30	10	647000	1@1	DFT_QAM64	24.00	23.51
n77(3700-3980)	30	10	647000	1@1	DFT_QAM256	22.00	21.48
n77(3700-3980)	30	10	647000	1@1	CP_QPSK	25.00	24.62
n77(3700-3980)	30	10	656000	1@1	DFT_BPSK	26.50	26.14
n77(3700-3980)	30	10	656000	24@0	DFT_QPSK	26.50	25.28
n77(3700-3980)	30	10	656000	12@6	DFT_QPSK	26.50	26.27
n77(3700-3980)	30	10	656000	1@1	DFT_QPSK	26.50	26.22
n77(3700-3980)	30	10	656000	1@22	DFT_QPSK	26.50	26.19
n77(3700-3980)	30	10	656000	1@1	DFT_QAM16	26.50	25.31
n77(3700-3980)	30	10	656000	1@1	DFT_QAM64	24.00	23.45
n77(3700-3980)	30	10	656000	1@1	DFT_QAM256	22.00	21.55
n77(3700-3980)	30	10	656000	1@1	CP_QPSK	25.00	24.76
n77(3700-3980)	30	10	665000	1@1	DFT_BPSK	26.50	26.25
n77(3700-3980)	30	10	665000	24@0	DFT_QPSK	26.50	25.39
n77(3700-3980)	30	10	665000	12@6	DFT_QPSK	26.50	26.41
n77(3700-3980)	30	10	665000	1@1	DFT_QPSK	26.50	26.24
n77(3700-3980)	30	10	665000	1@22	DFT_QPSK	26.50	26.29
n77(3700-3980)	30	10	665000	1@1	DFT_QAM16	26.50	25.33
n77(3700-3980)	30	10	665000	1@1	DFT_QAM64	24.00	23.65
n77(3700-3980)	30	10	665000	1@1	DFT_QAM256	22.00	21.61
n77(3700-3980)	30	10	665000	1@1	CP_QPSK	25.00	24.78
n77(3700-3980)	30	50	648334	1@1	DFT_BPSK	26.50	25.80
n77(3700-3980)	30	50	648334	128@0	DFT_QPSK	26.50	25.22

n77(3700-3980)	30	50	648334	64@32	DFT_QPSK	26.50	26.33
n77(3700-3980)	30	50	648334	1@1	DFT_QPSK	26.50	25.89
n77(3700-3980)	30	50	648334	1@131	DFT_QPSK	26.50	26.12
n77(3700-3980)	30	50	648334	1@1	DFT_QAM16	26.50	24.95
n77(3700-3980)	30	50	648334	1@1	DFT_QAM64	24.00	23.15
n77(3700-3980)	30	50	648334	1@1	DFT_QAM256	22.00	21.27
n77(3700-3980)	30	50	648334	1@1	CP_QPSK	25.00	24.36
n77(3700-3980)	30	50	656000	1@1	DFT_BPSK	26.50	25.97
n77(3700-3980)	30	50	656000	128@0	DFT_QPSK	26.50	25.25
n77(3700-3980)	30	50	656000	64@32	DFT_QPSK	26.50	26.33
n77(3700-3980)	30	50	656000	1@1	DFT_QPSK	26.50	26.04
n77(3700-3980)	30	50	656000	1@131	DFT_QPSK	26.50	25.93
n77(3700-3980)	30	50	656000	1@1	DFT_QAM16	26.50	25.13
n77(3700-3980)	30	50	656000	1@1	DFT_QAM64	24.00	23.35
n77(3700-3980)	30	50	656000	1@1	DFT_QAM256	22.00	21.34
n77(3700-3980)	30	50	656000	1@1	CP_QPSK	25.00	24.54
n77(3700-3980)	30	50	663666	1@1	DFT_BPSK	26.50	25.83
n77(3700-3980)	30	50	663666	128@0	DFT_QPSK	26.50	25.19
n77(3700-3980)	30	50	663666	64@32	DFT_QPSK	26.50	26.28
n77(3700-3980)	30	50	663666	1@1	DFT_QPSK	26.50	25.92
n77(3700-3980)	30	50	663666	1@131	DFT_QPSK	26.50	26.08
n77(3700-3980)	30	50	663666	1@1	DFT_QAM16	25.00	24.97
n77(3700-3980)	30	50	663666	1@1	DFT_QAM64	24.00	23.20
n77(3700-3980)	30	50	663666	1@1	DFT_QAM256	22.00	21.30
n77(3700-3980)	30	50	663666	1@1	CP_QPSK	25.00	24.42
n77(3700-3980)	30	100	650000	1@1	DFT_BPSK	26.50	25.23
n77(3700-3980)	30	100	650000	270@0	DFT_QPSK	26.50	25.09
n77(3700-3980)	30	100	650000	135@67	DFT_QPSK	26.50	26.34
n77(3700-3980)	30	100	650000	1@1	DFT_QPSK	26.50	25.35
n77(3700-3980)	30	100	650000	1@271	DFT_QPSK	26.50	25.62

n77(3700-3980)	30	100	650000	1@1	DFT_QAM16	25.00	24.28
n77(3700-3980)	30	100	650000	1@1	DFT_QAM64	23.00	22.46
n77(3700-3980)	30	100	650000	1@1	DFT_QAM256	21.00	20.94
n77(3700-3980)	30	100	650000	1@1	CP_QPSK	24.00	23.65
n77(3700-3980)	30	100	656000	1@1	DFT_BPSK	26.50	25.39
n77(3700-3980)	30	100	656000	270@0	DFT_QPSK	26.50	25.06
n77(3700-3980)	30	100	656000	135@67	DFT_QPSK	26.50	26.24
n77(3700-3980)	30	100	656000	1@1	DFT_QPSK	26.50	25.34
n77(3700-3980)	30	100	656000	1@271	DFT_QPSK	26.50	25.06
n77(3700-3980)	30	100	656000	1@1	DFT_QAM16	25.00	24.24
n77(3700-3980)	30	100	656000	1@1	DFT_QAM64	24.00	23.07
n77(3700-3980)	30	100	656000	1@1	DFT_QAM256	21.00	20.80
n77(3700-3980)	30	100	656000	1@1	CP_QPSK	24.00	23.95
n77(3700-3980)	30	100	662000	1@1	DFT_BPSK	26.50	25.28
n77(3700-3980)	30	100	662000	270@0	DFT_QPSK	26.50	25.06
n77(3700-3980)	30	100	662000	135@67	DFT_QPSK	26.50	26.20
n77(3700-3980)	30	100	662000	1@1	DFT_QPSK	26.50	25.30
n77(3700-3980)	30	100	662000	1@271	DFT_QPSK	26.50	25.46
n77(3700-3980)	30	100	662000	1@1	DFT_QAM16	25.00	24.24
n77(3700-3980)	30	100	662000	1@1	DFT_QAM64	23.00	22.89
n77(3700-3980)	30	100	662000	1@1	DFT_QAM256	21.00	20.86
n77(3700-3980)	30	100	662000	1@1	CP_QPSK	24.00	23.86

Band	SCS (kHz)	Bandwidth (MHz)	UL Channel	RB Allocation	Modulation	Tune-up	Power (dBm)
n77(3700-3980)	30	100	655000	1@1	DFT_BPSK	26.50	25.18
n77(3700-3980)	30	100	655000	270@0	DFT_QPSK	26.50	25.04
n77(3700-3980)	30	100	655000	135@67	DFT_QPSK	26.50	26.27
n77(3700-3980)	30	100	655000	1@1	DFT_QPSK	26.50	25.28
n77(3700-3980)	30	100	655000	1@271	DFT_QPSK	26.50	25.51
n77(3700-3980)	30	100	655000	1@1	DFT_QAM16	25.00	24.17
n77(3700-3980)	30	100	655000	1@1	DFT_QAM64	23.00	22.39
n77(3700-3980)	30	100	655000	1@1	DFT_QAM256	21.00	20.92

n77(3700-3980)	30	100	655000	1@1	CP_QPSK	24.00	23.58
n77(3700-3980)	30	100	659000	1@1	DFT_BPSK	26.50	25.33
n77(3700-3980)	30	100	659000	270@0	DFT_QPSK	26.50	25.01
n77(3700-3980)	30	100	659000	135@67	DFT_QPSK	26.50	26.20
n77(3700-3980)	30	100	659000	1@1	DFT_QPSK	26.50	25.32
n77(3700-3980)	30	100	659000	1@271	DFT_QPSK	26.50	25.04
n77(3700-3980)	30	100	659000	1@1	DFT_QAM16	25.00	24.18
n77(3700-3980)	30	100	659000	1@1	DFT_QAM64	24.00	23.01
n77(3700-3980)	30	100	659000	1@1	DFT_QAM256	21.00	20.65
n77(3700-3980)	30	100	659000	1@1	CP_QPSK	24.00	23.84
n77(3700-3980)	30	100	660000	1@1	DFT_BPSK	26.50	25.22
n77(3700-3980)	30	100	660000	270@0	DFT_QPSK	26.50	25.01
n77(3700-3980)	30	100	660000	135@67	DFT_QPSK	26.50	26.17
n77(3700-3980)	30	100	660000	1@1	DFT_QPSK	26.50	25.20
n77(3700-3980)	30	100	660000	1@271	DFT_QPSK	26.50	25.38
n77(3700-3980)	30	100	660000	1@1	DFT_QAM16	25.00	24.22
n77(3700-3980)	30	100	660000	1@1	DFT_QAM64	23.00	22.74
n77(3700-3980)	30	100	660000	1@1	DFT_QAM256	21.00	20.69
n77(3700-3980)	30	100	660000	1@1	CP_QPSK	24.00	23.76

7.5. WLAN & Bluetooth Output Power

Mode	Channel	Frequency (MHz)	Tune-up (dBm)	Output Power (dBm)ANT1	Tune-up (dBm)	Output Power (dBm)ANT2	Tune-up (dBm)	Output Power (dBm)MIMO
802.11b	1	2412	16.00	15.30	16.00	15.41	--	--
	6	2437	16.00	15.89	16.00	15.64	--	--
	11	2462	16.00	15.93	16.00	13.71	--	--
802.11g	1	2412	14.00	13.42	15.00	13.87	--	--
	6	2437	14.00	13.72	15.00	14.77	--	--
	11	2462	14.00	13.51	15.00	13.47	--	--
802.11n HT20	1	2412	14.00	13.66	14.00	13.74	18.50	18.02
	6	2437	14.00	13.88	14.00	13.82	18.50	18.07
	11	2462	14.00	13.83	14.00	12.33	18.50	17.93
802.11n HT40	3	2422	13.50	13.46	13.00	12.55	18.50	17.84
	6	2437	13.50	13.15	14.00	12.98	18.50	18.18
	9	2452	13.50	13.42	14.50	12.63	18.50	18.27
ax20	1	2412	14.00	13.09	14.50	13.71	18.50	18.33
	6	2437	14.00	13.18	14.50	14.05	18.50	18.22
	11	2462	14.00	13.21	14.50	12.71	18.50	18.14

ax40	3	2422	14.00	13.72	13.50	12.78	18.50	18.08
	6	2437	14.00	13.44	13.50	13.21	18.50	18.39
	9	2452	14.00	13.38	13.50	12.95	18.50	18.50

NOTE: Power measurement results of WLAN 2.4G.

Mode	Channel	Frequency (MHz)	Tune-up (dBm)	Output Power (dBm)ANT1	Tune-up (dBm)	Output Power (dBm)ANT2	Tune-up (dBm)	Output Power (dBm)MIMO
802.11a	36	5180	12.50	11.79	11.00	10.86	--	--
	40	5200	12.50	12.01	11.00	10.43	--	--
	48	5240	12.50	11.52	11.00	10.07	--	--
802.11n HT20	36	5180	12.00	11.58	11.00	10.60	16.00	15.47
	40	5200	12.00	11.93	11.00	10.31	16.00	15.30
	48	5240	12.00	11.26	11.00	9.99	17.00	16.96
802.11n HT40	38	5190	12.50	12.18	11.00	10.84	15.00	14.79
	46	5230	12.50	11.94	11.00	10.42	17.00	16.50
802.11ac VHT20	36	5180	12.00	11.73	11.00	10.78	15.00	14.62
	40	5200	12.00	11.92	11.00	10.36	16.00	15.03
	48	5240	12.00	11.45	11.00	10.02	17.00	16.74
802.11ac VHT40	38	5190	12.50	12.16	11.00	10.62	15.00	14.57
	46	5230	12.50	11.98	11.00	9.73	17.00	16.40
802.11ac VHT80	42	5210	12.00	11.66	10.50	10.22	15.00	14.22
ax20	36	5180	12.50	12.22	11.50	11.11	15.00	14.77
	40	5200	12.50	12.14	11.50	10.61	16.00	15.15
	48	5240	12.50	11.71	11.50	10.28	17.00	16.67
ax40	38	5190	13.00	12.52	11.00	10.19	15.00	14.78
	46	5230	13.00	12.16	11.00	10.66	17.00	16.44
ax80	42	5210	13.00	12.24	11.00	9.67	15.00	14.54

NOTE: Power measurement results of WLAN 5.2G.

Mode	Channel	Frequency (MHz)	Tune-up (dBm)	Output Power (dBm)ANT1	Tune-up (dBm)	Output Power (dBm)ANT2	Tune-up (dBm)	Output Power (dBm)MIMO
802.11a	52	5260	14.00	12.73	11.00	9.90	--	--
	56	5280	14.00	12.51	11.00	10.77	--	--
	64	5320	14.00	13.58	11.00	10.00	--	--

802.11n HT20	52	5260	13.50	12.79	11.00	10.05	15.00	14.90
	56	5280	13.50	13.22	11.00	10.08	15.00	14.21
	64	5320	13.50	12.33	11.00	10.73	15.00	13.46
802.11n HT40	54	5270	12.50	12.30	10.50	10.17	15.00	14.46
	62	5310	12.50	11.74	10.50	9.76	14.00	13.00
802.11ac VHT20	52	5260	13.00	12.16	11.00	9.19	16.00	15.01
	56	5280	13.00	12.67	11.00	10.10	15.00	14.28
	64	5320	13.00	12.24	11.00	10.53	15.00	13.08
802.11ac VHT40	54	5270	12.50	12.19	10.50	10.25	15.00	14.29
	62	5310	12.50	12.18	10.50	10.34	13.00	12.90
802.11ac VHT80	58	5290	10.00	9.90	9.50	9.42	15.00	14.23
ax20	52	5260	13.00	12.98	8.00	7.56	15.50	15.01
	56	5280	12.50	12.46	10.00	9.51	15.00	14.24
	64	5320	13.00	12.54	10.00	9.60	15.00	13.26
ax40	54	5270	12.50	12.37	9.50	9.44	15.00	14.43
	62	5310	12.50	12.03	9.50	9.47	15.00	13.22
ax80	58	5290	11.00	10.55	9.50	9.49	15.00	14.45

NOTE: Power measurement results of WLAN 5.3G.

Mode	Channel	Frequency (MHz)	Tune-up (dBm)	Output Power (dBm)ANT1	Tune-up (dBm)	Output Power (dBm)ANT2	Tune-up (dBm)	Output Power (dBm)MIMO
802.11a	100	5500	12.50	12.48	11.00	9.71	--	--
	120	5600	12.50	12.27	11.00	10.51	--	--
	140	5700	12.50	12.05	11.00	10.20	--	--
802.11n	100	5500	13.00	12.81	10.50	9.75	15.00	13.35
	120	5600	13.00	11.40	10.50	10.20	15.00	13.85
	140	5700	13.00	11.76	10.50	10.15	15.00	14.63
802.11n	102	5510	11.00	10.83	11.00	9.89	15.00	13.47
	118	5590	12.00	11.11	11.00	10.06	15.00	13.41
	134	5670	13.00	12.56	11.00	10.60	15.00	14.66
802.11ac (VHT20)	100	5500	13.00	12.54	10.50	9.63	15.00	13.11
	120	5600	13.00	12.61	10.50	10.27	15.00	13.80
	140	5700	13.00	12.86	10.50	10.12	15.00	14.34
802.11ac	102	5510	12.50	11.74	11.00	9.88	15.00	13.26

(VHT40)	118	5590	12.50	11.64	11.00	10.01	15.00	13.25
	134	5670	12.50	12.32	11.00	10.50	15.00	14.70
802.11ac	106	5530	12.00	11.28	11.00	9.88	13.00	12.60
(VHT80)	122	5610	13.00	11.56	11.00	10.63	15.00	13.48
ax20	100	5500	13.00	12.95	10.50	10.01	15.00	13.93
	120	5600	13.50	12.91	10.50	10.43	15.00	13.97
	140	5700	13.50	13.11	10.50	10.32	15.00	14.20
ax40	102	5510	13.00	12.63	10.50	10.03	15.00	13.52
	118	5590	13.00	11.67	11.00	10.11	15.00	13.58
	134	5670	13.00	12.66	11.00	10.81	15.00	14.94
ax80	106	5530	12.00	11.44	11.50	10.25	15.00	13.03
	122	5610	12.00	11.90	11.50	11.11	15.00	13.60

NOTE: Power measurement results of WLAN 5.6G.

Mode	Channel	Frequency (MHz)	Tune-up (dBm)	Output Power (dBm)ANT1	Tune-up (dBm)	Output Power (dBm)ANT2	Tune-up (dBm)	Output Power (dBm)MIMO
802.11a	149	5745	14.50	14.27	10.50	10.10	--	--
	157	5785	14.50	13.72	10.50	9.90	--	--
	165	5825	14.50	13.84	10.50	10.00	--	--
802.11n HT20	149	5745	13.00	12.34	10.00	9.98	15.00	14.32
	157	5785	13.00	12.71	10.00	9.45	15.00	14.81
	165	5825	13.00	12.80	10.00	9.79	15.00	14.34
802.11n HT40	151	5755	13.50	12.71	10.50	10.03	15.00	13.53
	159	5795	13.50	13.19	10.50	10.42	15.00	13.94
802.11ac VHT20	149	5745	13.00	12.36	10.50	10.10	15.00	14.32
	157	5785	13.00	12.77	10.50	9.60	15.00	14.69
	165	5825	13.00	12.87	10.50	10.01	15.00	14.33
802.11ac VHT40	151	5755	13.00	12.71	10.50	10.05	15.00	14.46
	159	5795	13.00	12.98	10.50	10.33	15.00	14.49
802.11ac VHT80	155	5775	13.00	12.71	10.00	9.67	15.00	13.32
ax20	149	5745	13.00	12.64	10.50	10.30	15.00	14.75
	157	5785	13.00	13.00	10.00	9.77	15.00	14.91
	165	5825	13.50	13.17	10.50	10.17	15.00	14.31
ax40	151	5755	13.00	13.00	10.50	10.19	15.00	14.52
	159	5795	13.50	13.34	10.50	10.30	15.00	14.71

ax80	155	5775	13.50	13.08	10.00	9.78	15.00	13.20
------	-----	------	-------	-------	-------	------	-------	-------

NOTE: Power measurement results of WLAN 5.8G.

BR+EDR	Output Power (dBm)				
	Channel	Tune-up (dBm)	Data Rates		
			1M	2M	3M
	0CH	5.00	4.71	4.24	4.59
	39CH	6.00	5.41	5.13	5.45
	78CH	5.00	4.04	3.63	4.10

BLE	Channel	Tune-up (dBm)	Output Power (dBm)	
			1M	2M
		0CH	5.00	4.86
	19CH	6.00	5.58	5.65
	39CH	4.50	3.99	4.23

NOTE: Power measurement results of Bluetooth.

7.6. NFC

The power is too low, so SAR testing is not necessary.

8. Antenna Location

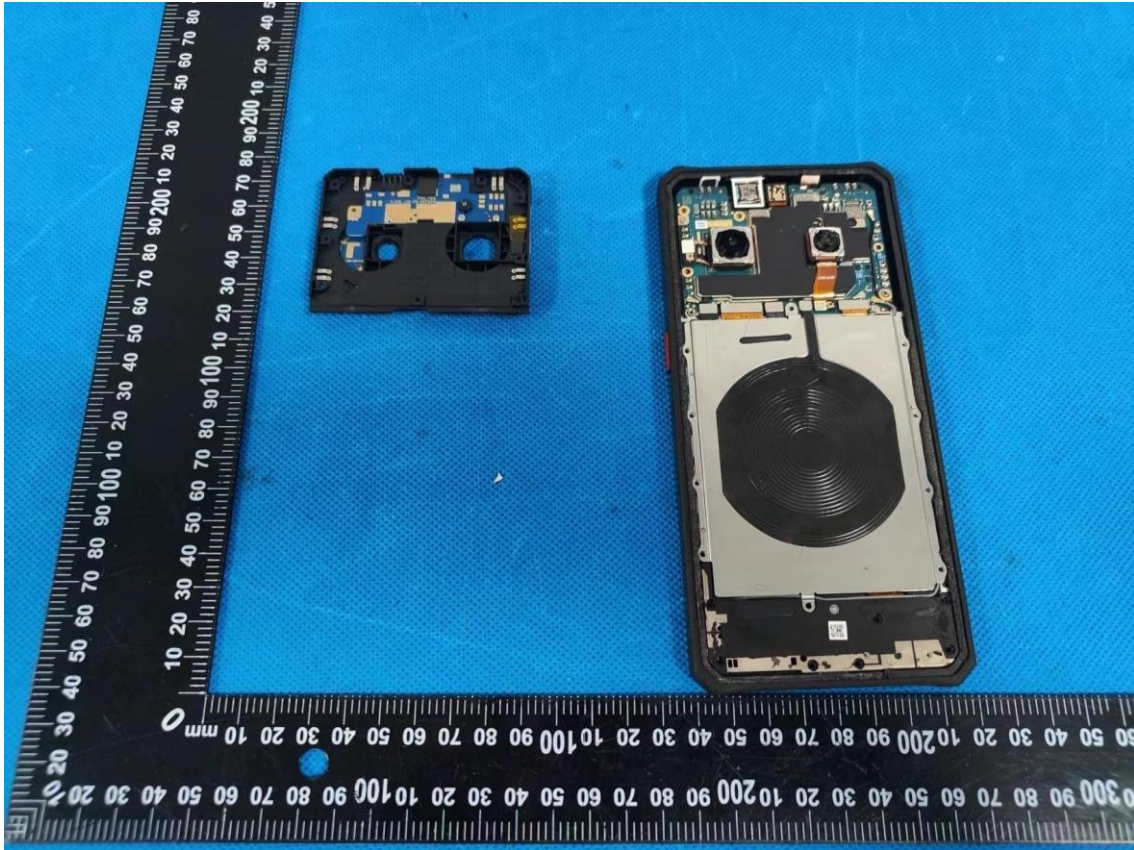

Rigth Side

170mm

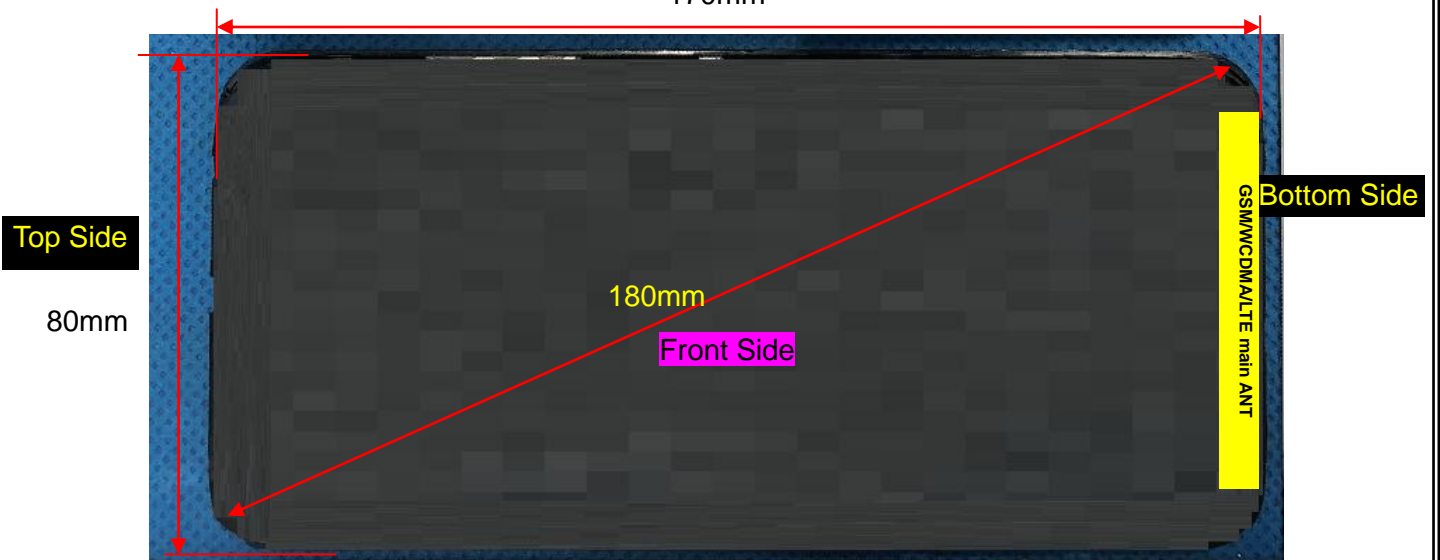

Left Side

Front View

Note: Since the confidentiality request of EUT, the antenna location example diagram see as above.

Positions for SAR tests						
Antennas	Front Side	Back Side	Left Side	Right Side	Top Side	Bottom Side
WWAN Main ANT	Yes	Yes	Yes	Yes	NO	Yes

WLAN & Bluetooth	Yes	Yes	Yes	Yes	Yes	Yes
NR SA	Yes	Yes	Yes	Yes	Yes	Yes

9. Stand-alone SAR test exclusion

Refer to FCC KDB 447498D01, the 1-g SAR and 10-g SAR test exclusion thresholds for 100 MHz to 6 GHz at test separation distances ≤ 50 mm are determined by:

$[(\text{max. power of channel, including tune-up tolerance, mW})/(\text{min. test separation distance, mm})] \cdot [\sqrt{f_{(\text{GHz})}}] \leq 3.0$ for 1-g SAR and ≤ 7.5 for 10-g extremity SAR, where:

- $f_{(\text{GHz})}$ is the RF channel transmit frequency in GHz
- Power and distance are rounded to the nearest mW and mm before calculation
- The result is rounded to one decimal place for comparison

When the minimum test separation distance is < 5 mm, a distance of 5 mm is applied to determine SAR test exclusion.

Mode	P_{max} (dBm)	P_{max} (mW)	Distance (mm)	f (GHz)	Calculation Result	SAR Exclusion threshold	SAR test exclusion
Bluetooth	6.00	3.98	5	2.480	1.2	3	Yes

NOTE: Standalone SAR test exclusion for Bluetooth.

When standalone SAR test exclusion applies to an antenna that transmits simultaneously with other antennas, the standalone SAR must be estimated according to following to determine simultaneous transmission SAR test exclusion:

$[(\text{max. power of channel, including tune-up tolerance, mW})/(\text{min. test separation distance, mm})] * [\sqrt{f_{(\text{GHz})}/x}] \text{ W/kg}$ for test separation distances $\leq 50\text{mm}$, where $x = 7.5$ for 1-g SAR and $x = 18.75$ for 10-g SAR.

When the minimum test separation distance is < 5 mm, a distance of 5 mm is applied to determine SAR test exclusion.

Mode	Position	P_{max} (dBm)	P_{max} (mW)	Distance (mm)	f (GHz)	x	Estimated SAR (W/Kg)
Bluetooth	Head	6.00	3.98	5	2.48	7.5	0.167
Bluetooth	Body	6.00	3.98	10	2.48	7.5	0.083
Bluetooth	Hotspot	6.00	3.98	10	2.48	7.5	0.083

NOTE: Estimated SAR calculation for Bluetooth

10. SAR Results

10.1. SAR measurement Result

10.1.1. SAR measurement Result of GSM850

Test Position of Head	Test channel /Freq.	Mode	SAR Value (W/kg)		Power Drift(%)	Conducted Power (dBm)	Tune-up Power (dBm)	Scaled SAR 1-g (W/Kg)	Date	Plot
			1-g	10-g						
Left Cheek	189/836.4	GPRS(GMSK 4TS)	0.091	0.073	0.99	29.73	30.00	0.097	2024/3/01	1#
Left Tilt 15 Degree	189/836.4	GPRS(GMSK 4TS)	0.047	0.036	-1.57	29.73	30.00	0.050	2024/3/01	
Right Cheek	189/836.4	GPRS(GMSK 4TS)	0.082	0.064	-2.52	29.73	30.00	0.087	2024/3/01	
Right Tilt 15 Degree	189/836.4	GPRS(GMSK 4TS)	0.042	0.033	3.73	29.73	30.00	0.045	2024/3/01	

NOTE: Head SAR test results of GSM850.

Test Position of Body-Worn with 10mm	Test channel /Freq.	Test Mode	SAR Value (W/kg)		Power Drift (±5%)	Conducted power (dBm)	Tune-up power (dBm)	Scaled SAR 1g (W/Kg)	Date	Plot
			1g	10g						
Front Side	189/836.4	GPRS(GMSK 4TS)	0.252	0.135	2.92	29.73	30.00	0.268	2024/3/01	
Back Side	189/836.4	GPRS(GMSK 4TS)	0.389	0.212	-0.96	29.73	30.00	0.414	2024/3/01	2#

NOTE: Body-Worn SAR test results of GSM850

Test Position of Hotspot with 10mm	Test channel /Freq.	Mode	SAR Value (W/kg)		Power Drift(%)	Conducted Power (dBm)	Tune-up Power (dBm)	Scaled SAR 1-g (W/Kg)	Date	Plot
			1-g	10-g						
Front Side	189/836.4	GPRS(GMSK 4TS)	0.252	0.135	2.92	29.73	30.00	0.268	2024/3/01	
Back Side	189/836.4	GPRS(GMSK 4TS)	0.389	0.212	-0.96	29.73	30.00	0.414	2024/3/01	2#
Left Side	189/836.4	GPRS(GMSK 4TS)	0.129	0.070	0.43	29.73	30.00	0.137	2024/3/01	
Right Side	189/836.4	GPRS(GMSK 4TS)	0.120	0.065	2.61	29.73	30.00	0.128	2024/3/01	
Bottom Side	189/836.4	GPRS(GMSK 4TS)	0.215	0.114	-0.29	29.73	30.00	0.229	2024/3/01	

NOTE: Hotspot SAR test results of GSM850

10.1.2. SAR measurement Result of GSM1900

Test Position of Head	Test channel /Freq.	Mode	SAR Value (W/kg)		Power Drift(%)	Conducted Power (dBm)	Tune-up Power (dBm)	Scaled SAR 1-g (W/Kg)	Date	Plot
			1-g	10-g						
Left Cheek	661/1880	GPRS(GMSK 3TS)	0.639	0.355	-2.94	27.82	28.50	0.747	2024/3/02	3#
Left Tilt 15 Degree	661/1880	GPRS(GMSK 3TS)	0.344	0.185	-0.58	27.82	28.50	0.402	2024/3/02	
Right Cheek	661/1880	GPRS(GMSK 3TS)	0.544	0.287	-1.64	27.82	28.50	0.636	2024/3/02	
Right Tilt 15 Degree	661/1880	GPRS(GMSK 3TS)	0.268	0.144	1.89	27.82	28.50	0.313	2024/3/02	

NOTE: Head SAR test results of GSM1900

Test Position of Body-Worn with 10mm	Test channel /Freq.	Test Mode	SAR Value (W/kg)		Power Drift (±5%)	Conducted power (dBm)	Tune-up power (dBm)	Scaled SAR 1g (W/Kg)	Date	Plot
			1g	10g						
Front Side	661/1880	GPRS(GMSK 3TS)	0.372	0.183	0.07	27.82	28.50	0.435	2024/3/02	
Back Side	661/1880	GPRS(GMSK 3TS)	0.611	0.300	0.78	27.82	28.50	0.715	2024/3/02	4#

NOTE: Body-Worn SAR test results of GSM1900

Test Position of Hotspot with 10mm	Test channel /Freq.	Mode	SAR Value (W/kg)		Power Drift(%)	Conducte d Power (dBm)	Tune-up Power (dBm)	Scale d SAR 1-g (W/K g)	Date	Plot
			1-g	10-g						
Front Side	661/1880	GPRS(GMSK 3TS)	0.372	0.183	0.07	27.82	28.50	0.435	2024/3/02	
Back Side	661/1880	GPRS(GMSK 3TS)	0.611	0.300	0.78	27.82	28.50	0.715	2024/3/02	4#
Left Side	661/1880	GPRS(GMSK 3TS)	0.202	0.096	-3.70	27.82	28.50	0.236	2024/3/02	
Right Side	661/1880	GPRS(GMSK 3TS)	0.198	0.092	-0.17	27.82	28.50	0.232	2024/3/02	

Bottom Side	661/1880	GPRS(GMSK 3TS)	0.310	0.146	1.38	27.82	28.50	0.363	2024/3/02	
-------------	----------	----------------	-------	-------	------	-------	-------	-------	-----------	--

NOTE: Hotspot SAR test results of GSM1900

10.1.3. SAR measurement Result of WCDMA Band 2

Test Position of Head	Test channel /Freq	Mode	SAR Value (W/kg)		Power Drift(%)	Conducted Power (dBm)	Tune-up Power (dBm)	Scaled SAR 1-g (W/Kg)	Date	Plot
			1-g	10-g						
Left Cheek	9400/1880	RMC12.2K	0.570	0.329	1.95	23.99	24.00	0.571	2024/3/02	5#
Left Tilt 15 Degree	9400/1880	RMC12.2K	0.292	0.163	2.24	23.99	24.00	0.293	2024/3/02	
Right Cheek	9400/1880	RMC12.2K	0.495	0.280	2.41	23.99	24.00	0.496	2024/3/02	
Right Tilt 15 Degree	9400/1880	RMC12.2K	0.241	0.135	-2.59	23.99	24.00	0.242	2024/3/02	

NOTE: Head SAR test results of WCDMA Band 2

Test Position of Body-Worn with 10mm	Test channel /Freq.	Test Mode	SAR Value (W/kg)		Power Drift (±5%)	Conducted power (dBm)	Tune-up power (dBm)	Scaled SAR 1g (W/Kg)	Date	Plot
			1g	10g						
Front Side	9400/1880	RMC12.2K	0.354	0.177	1.38	23.99	24.00	0.355	2024/3/02	
Back Side	9400/1880	RMC12.2K	0.558	0.285	0.46	23.99	24.00	0.559	2024/3/02	6#

NOTE: Body-Worn SAR test results of WCDMA Band 2

Test Position of Hotspot with 10mm	Test channel /Freq.	Mode	SAR Value (W/kg)		Power Drift(%)	Conducte d Power (dBm)	Tune-u p Power (dBm)	Scaled SAR 1-g (W/Kg)	Date	Plot
			1-g	10-g						
Front Side	9400/1880	RMC12.2K	0.354	0.177	1.38	23.99	24.00	0.355	2024/3/02	
Back Side	9400/1880	RMC12.2K	0.558	0.285	0.46	23.99	24.00	0.559	2024/3/02	6#
Left Side	9400/1880	RMC12.2K	0.177	0.090	3.63	23.99	24.00	0.177	2024/3/02	
Right Side	9400/1880	RMC12.2K	0.174	0.084	-0.96	23.99	24.00	0.174	2024/3/02	

Bottom Side	9400/1880	RMC12.2K	0.300	0.152	1.68	23.99	24.00	0.301	2024/3/02	
-------------	-----------	----------	-------	-------	------	-------	-------	-------	-----------	--

NOTE: Hotspot SAR test results of WCDMA Band 2

10.1.4. SAR measurement Result of WCDMA Band 4

Test Position of Head	Test channel /Freq	Mode	SAR Value (W/kg)		Power Drift(%)	Conducted Power (dBm)	Tune-up Power (dBm)	Scaled SAR 1-g (W/Kg)	Date	Plot
			1-g	10-g						
Left Cheek	1413/1732.6	RMC12.2K	0.499	0.302	-1.04	23.66	24.00	0.540	2024/2/29	7#
Left Tilt 15 Degree	1413/1732.6	RMC12.2K	0.271	0.157	-3.00	23.66	24.00	0.293	2024/2/29	
Right Cheek	1413/1732.6	RMC12.2K	0.456	0.262	3.82	23.66	24.00	0.493	2024/2/29	
Right Tilt 15 Degree	1413/1732.6	RMC12.2K	0.228	0.137	1.69	23.66	24.00	0.247	2024/2/29	

NOTE: Head SAR test results of WCDMA Band 4

Test Position of Body-Worn with 10mm	Test channel /Freq.	Test Mode	SAR Value (W/kg)		Power Drift (±5%)	Conducted power (dBm)	Tune-up power (dBm)	Scaled SAR 1g (W/Kg)	Date	Plot
			1g	10g						
Front Side	1413/1732.6	RMC12.2K	0.282	0.147	-0.81	23.66	24.00	0.305	2024/2/29	
Back Side	1413/1732.6	RMC12.2K	0.427	0.223	0.62	23.66	24.00	0.462	2024/2/29	8#

NOTE: Body-Worn SAR test results of WCDMA Band 4

Test Position of Hotspot with 10mm	Test channel /Freq.	Mode	SAR Value (W/kg)		Power Drift(%)	Conducted Power (dBm)	Tune-up Power (dBm)	Scaled SAR 1-g (W/Kg)	Date	Plot
			1-g	10-g						
Front Side	1413/1732.6	RMC12.2K	0.282	0.147	-0.81	23.66	24.00	0.305	2024/2/29	
Back Side	1413/1732.6	RMC12.2K	0.427	0.223	0.62	23.66	24.00	0.462	2024/2/29	8#

Left Side	1413/1732.6	RMC12.2K	0.145	0.074	0.66	23.66	24.00	0.157	2024/2/29	
Right Side	1413/1732.6	RMC12.2K	0.141	0.070	3.56	23.66	24.00	0.152	2024/2/29	
Bottom Side	1413/1732.6	RMC12.2K	0.225	0.116	-2.47	23.66	24.00	0.243	2024/2/29	

NOTE: Hotspot SAR test results of WCDMA Band 4

10.1.5. SAR measurement Result of WCDMA Band 5

Test Position of Head	Test channel /Freq	Mode	SAR Value (W/kg)		Power Drift(%)	Conducted Power (dBm)	Tune-up Power (dBm)	Scaled SAR 1-g (W/Kg)	Date	Plot
			1-g	10-g						
Left Cheek	4182/836.4	RMC12.2K	0.060	0.049	0.17	23.66	24.00	0.065	2024/3/01	9#
Left Tilt 15 Degree	4182/836.4	RMC12.2K	0.033	0.026	2.55	23.66	24.00	0.036	2024/3/01	
Right Cheek	4182/836.4	RMC12.2K	0.057	0.045	-1.59	23.66	24.00	0.062	2024/3/01	
Right Tilt 15 Degree	4182/836.4	RMC12.2K	0.027	0.022	-3.94	23.66	24.00	0.029	2024/3/01	

NOTE: Head SAR test results of WCDMA Band 5

Test Position of Body-Worn with 10mm	Test channel /Freq.	Test Mode	SAR Value (W/kg)		Power Drift (±5%)	Conducted power (dBm)	Tune-up power (dBm)	Scaled SAR 1g (W/Kg)	Date	Plot
			1g	10g						
Front Side	4182/836.4	RMC12.2K	0.132	0.071	0.94	23.66	24.00	0.143	2024/3/01	
Back Side	4182/836.4	RMC12.2K	0.214	0.120	-4.69	23.66	24.00	0.231	2024/3/01	10#

NOTE: Body-Worn SAR test results of WCDMA Band 5

Test Position of Hotspot with 10mm	Test channel /Freq.	Mode	SAR Value (W/kg)		Power Drift(%)	Conducted Power (dBm)	Tune-up Power (dBm)	Scaled SAR 1-g (W/Kg)	Date	Plot
			1-g	10-g						
Front Side	4182/836.4	RMC12.2K	0.132	0.071	0.94	23.66	24.00	0.143	2024/3/01	
Back Side	4182/836.4	RMC12.2K	0.214	0.120	-4.69	23.66	24.00	0.231	2024/3/01	10#

Left Side	4182/836.4	RMC12.2K	0.078	0.043	3.92	23.66	24.00	0.084	2024/3/01	
Right Side	4182/836.4	RMC12.2K	0.069	0.037	-2.28	23.66	24.00	0.075	2024/3/01	
Bottom Side	4182/836.4	RMC12.2K	0.130	0.072	3.19	23.66	24.00	0.141	2024/3/01	

NOTE: Hotspot SAR test results of WCDMA Band 5

10.1.6. SAR measurement Result of LTE Band 2

Test Position of Head	Test channel /Freq.	Mode	SAR Value (W/kg)		Power Drift(%)	Conducted Power (dBm)	Tune-up Power (dBm)	Scaled SAR 1-g (W/Kg)	Date	Plot
			1-g	10-g						
1RB										
Left Cheek	18900/1880	20M QPSK(1,49)	0.608	0.358	2.64	23.17	23.50	0.656	2024/3/02	31#
Left Tilt 15 Degree	18900/1880	20M QPSK(1,49)	0.359	0.201	2.16	23.17	23.50	0.387	2024/3/02	
Right Cheek	18900/1880	20M QPSK(1,49)	0.565	0.323	-3.56	23.17	23.50	0.610	2024/3/02	
Right Tilt 15 Degree	18900/1880	20M QPSK(1,49)	0.303	0.169	0.40	23.17	23.50	0.327	2024/3/02	
50%RB										
Left Cheek	18900/1880	20M QPSK(50,0)	0.310	0.182	0.23	22.33	22.50	0.322	2024/3/02	
Left Tilt 15 Degree	18900/1880	20M QPSK(50,0)	0.201	0.116	-2.98	22.33	22.50	0.209	2024/3/02	
Right Cheek	18900/1880	20M QPSK(50,0)	0.304	0.172	-0.59	22.33	22.50	0.316	2024/3/02	
Right Tilt 15 Degree	18900/1880	20M QPSK(50,0)	0.181	0.093	3.64	22.33	22.50	0.188	2024/3/02	

NOTE: Head SAR test results of LTE Band 2

Test	Test	Test Mode	SAR Value	Power	Conducted	Tune-up	Scaled	Date	Plot
------	------	-----------	-----------	-------	-----------	---------	--------	------	------

Position of Body-Worn with 10mm	channel /Freq.		(W/kg)		Drift (±5%)	power (dBm)	power (dBm)	SAR 1g (W/Kg)		
			1g	10g						
1RB										
Front Side	18900/1880	20M QPSK(1,49)	0.378	0.193	3.38	23.17	23.50	0.408	2024/3/02	
Back Side	18900/1880	20M QPSK(1,49)	0.624	0.329	3.16	23.17	23.50	0.673	2024/3/02	32#
50%RB										
Front Side	18900/1880	20M QPSK(50,0)	0.208	0.100	4.37	22.33	22.50	0.216	2024/3/02	
Back Side	18900/1880	20M QPSK(50,0)	0.361	0.196	-2.01	22.33	22.50	0.375	2024/3/02	

NOTE: Body-Worn SAR test results of LTE Band 2

Test Position of Hotspot with 10mm	Test channel /Freq.	Mode	SAR Value (W/kg)		Power Drift(%)	Conducted Power (dBm)	Tune-up Power (dBm)	Scaled SAR 1-g (W/Kg)	Date	Plot
			1-g	10-g						
1RB										
Front Side	18900/1880	20M QPSK(1,49)	0.378	0.193	3.38	23.17	23.50	0.408	2024/3/02	
Back Side	18900/1880	20M QPSK(1,49)	0.624	0.329	3.16	23.17	23.50	0.673	2024/3/02	32#
Left Side	18900/1880	20M QPSK(1,49)	0.201	0.105	-0.37	23.17	23.50	0.217	2024/3/02	
Right Side	18900/1880	20M QPSK(1,49)	0.198	0.101	-1.07	23.17	23.50	0.214	2024/3/02	
Bottom Side	18900/1880	20M QPSK(1,49)	0.320	0.164	1.22	23.17	23.50	0.345	2024/3/02	
50%RB										
Front Side	18900/1880	20M QPSK(50,0)	0.208	0.100	4.37	22.33	22.50	0.216	2024/3/02	
Back Side	18900/1880	20M QPSK(50,0)	0.361	0.196	-2.01	22.33	22.50	0.375	2024/3/02	
Left Side	18900/1880	20M QPSK(50,0)	0.111	0.059	-3.37	22.33	22.50	0.115	2024/3/02	
Right Side	18900/1880	20M QPSK(50,0)	0.110	0.058	-3.77	22.33	22.50	0.114	2024/3/02	
Bottom Side	18900/1880	20M QPSK(50,0)	0.174	0.086	4.13	22.33	22.50	0.181	2024/3/02	

NOTE: Hotspot SAR test results of LTE Band 2

10.1.7. SAR measurement Result of LTE Band 4

Test Position of Head	Test channel /Freq.	Mode	SAR Value (W/kg)		Power Drift(%)	Conducted Power (dBm)	Tune-up Power (dBm)	Scaled SAR 1-g (W/Kg)	Date	Plot
			1-g	10-g						

1RB										
Left Cheek	20175/1732.5	20M QPSK(1,0)	0.406	0.241	-3.00	22.64	23.00	0.441	2024/2/29	33#
Left Tilt 15 Degree	20175/1732.5	20M QPSK(1,0)	0.214	0.124	-1.48	22.64	23.00	0.232	2024/2/29	
Right Cheek	20175/1732.5	20M QPSK(1,0)	0.373	0.215	0.81	22.64	23.00	0.405	2024/2/29	
Right Tilt 15 Degree	20175/1732.5	20M QPSK(1,0)	0.175	0.101	-1.01	22.64	23.00	0.190	2024/2/29	
50%RB										
Left Cheek	20175/1732.5	20M QPSK(50,49)	0.237	0.140	-1.53	21.95	22.00	0.240	2024/2/29	
Left Tilt 15 Degree	20175/1732.5	20M QPSK(50,49)	0.120	0.068	0.29	21.95	22.00	0.121	2024/2/29	
Right Cheek	20175/1732.5	20M QPSK(50,49)	0.203	0.116	0.32	21.95	22.00	0.205	2024/2/29	
Right Tilt 15 Degree	20175/1732.5	20M QPSK(50,49)	0.099	0.051	0.36	21.95	22.00	0.100	2024/2/29	

NOTE: Head SAR test results of LTE Band 4

Test Position of Body-Worn with 10mm	Test channel /Freq.	Test Mode	SAR Value (W/kg)		Power Drift (±5%)	Conducted power (dBm)	Tune-up power (dBm)	Scaled SAR 1g (W/Kg)	Date	Plot
			1g	10g						
1RB										
Front Side	20175/1732.5	20M QPSK(1,0)	0.228	0.116	0.06	22.64	23.00	0.248	2024/2/29	
Back Side	20175/1732.5	20M QPSK(1,0)	0.346	0.182	0.33	22.64	23.00	0.376	2024/2/29	34#
50%RB										
Front Side	20175/1732.5	20M QPSK(50,49)	0.118	0.060	-3.63	21.95	22.00	0.119	2024/2/29	
Back	20175/1732.5	20M QPSK(50,49)	0.173	0.106	-0.68	21.95	22.00	0.175	2024/2/29	

Side										
------	--	--	--	--	--	--	--	--	--	--

NOTE: Body-Worn SAR test results of LTE Band 4

Test Position of Hotspot with 10mm	Test channel /Freq.	Mode	SAR Value (W/kg)		Power Drift(%)	Conducted Power (dBm)	Tune-up Power (dBm)	Scaled SAR 1-g (W/Kg)	Date	Plot
			1-g	10-g						
1RB										
Front Side	20175/1732.5	20M QPSK(1,0)	0.228	0.116	0.06	22.64	23.00	0.248	2024/2/29	
Back Side	20175/1732.5	20M QPSK(1,0)	0.346	0.182	0.33	22.64	23.00	0.376	2024/2/29	34#
Left Side	20175/1732.5	20M QPSK(1,0)	0.111	0.058	-0.66	22.64	23.00	0.121	2024/2/29	
Right Side	20175/1732.5	20M QPSK(1,0)	0.108	0.056	0.51	22.64	23.00	0.117	2024/2/29	
Bottom Side	20175/1732.5	20M QPSK(1,0)	0.190	0.095	-2.95	22.64	23.00	0.206	2024/2/29	
50%RB										
Front Side	20175/1732.5	20M QPSK(50,49)	0.118	0.060	-3.63	21.95	22.00	0.119	2024/2/29	
Back Side	20175/1732.5	20M QPSK(50,49)	0.173	0.106	-0.68	21.95	22.00	0.175	2024/2/29	
Left Side	20175/1732.5	20M QPSK(50,49)	0.065	0.034	3.97	21.95	22.00	0.066	2024/2/29	
Right Side	20175/1732.5	20M QPSK(50,49)	0.063	0.030	-3.49	21.95	22.00	0.064	2024/2/29	
Bottom Side	20175/1732.5	20M QPSK(50,49)	0.095	0.056	1.08	21.95	22.00	0.096	2024/2/29	

NOTE: Hotspot SAR test results of LTE Band 4

10.1.8. SAR measurement Result of LTE Band 5

Test Position of Head	Test channel /Freq.	Mode	SAR Value (W/kg)		Power Drift(%)	Conducted Power (dBm)	Tune-up Power (dBm)	Scaled SAR 1-g (W/Kg)	Date	Plot
			1-g	10-g						
1RB										

Left Cheek	20525/836.5	10M QPSK(1,24)	0.071	0.057	4.82	24.06	24.50	0.079	2024/3/01	35#
Left Tilt 15 Degree	20525/836.5	10M QPSK(1,24)	0.038	0.031	-0.04	24.06	24.50	0.042	2024/3/01	
Right Cheek	20525/836.5	10M QPSK(1,24)	0.066	0.050	-2.96	24.06	24.50	0.073	2024/3/01	
Right Tilt 15 Degree	20525/836.5	10M QPSK(1,24)	0.034	0.027	3.24	24.06	24.50	0.038	2024/3/01	
50%RB										
Left Cheek	20525/836.5	10M QPSK(25,0)	0.041	0.030	2.52	23.02	23.50	0.046	2024/3/01	
Left Tilt 15 Degree	20525/836.5	10M QPSK(25,0)	0.022	0.017	-1.78	23.02	23.50	0.025	2024/3/01	
Right Cheek	20525/836.5	10M QPSK(25,0)	0.035	0.030	2.54	23.02	23.50	0.039	2024/3/01	
Right Tilt 15 Degree	20525/836.5	10M QPSK(25,0)	0.019	0.016	-1.44	23.02	23.50	0.021	2024/3/01	

NOTE: Head SAR test results of LTE Band 5

Test Position of Body-Worn with 10mm	Test channel /Freq.	Test Mode	SAR Value (W/kg)		Power Drift (±5%)	Conducted power (dBm)	Tune-up power (dBm)	Scaled SAR 1g (W/Kg)	Date	Plot
			1g	10g						
1RB										
Front Side	20525/836.5	10M QPSK(1,24)	0.168	0.091	-1.36	24.06	24.50	0.186	2024/3/01	
Back Side	20525/836.5	10M QPSK(1,24)	0.248	0.141	-1.37	24.06	24.50	0.274	2024/3/01	36#
50%RB										
Front Side	20525/836.5	10M QPSK(25,0)	0.094	0.048	3.73	23.02	23.50	0.105	2024/3/01	
Back Side	20525/836.5	10M QPSK(25,0)	0.137	0.084	-0.59	23.02	23.50	0.153	2024/3/01	

NOTE: Body-Worn SAR test results of LTE Band 5

Test Position of Hotspot with 10mm	Test channel /Freq.	Mode	SAR Value (W/kg)		Power Drift(%)	Conducted Power (dBm)	Tune-up Power (dBm)	Scaled SAR 1-g (W/Kg)	Date	Plot
			1-g	10-g						
1RB										
Front Side	20525/836.5	10M QPSK(1,24)	0.168	0.091	-1.36	24.06	24.50	0.186	2024/3/01	
Back Side	20525/836.5	10M QPSK(1,24)	0.248	0.141	-1.37	24.06	24.50	0.274	2024/3/01	36#
Left Side	20525/836.5	10M QPSK(1,24)	0.090	0.052	1.42	24.06	24.50	0.100	2024/3/01	
Right Side	20525/836.5	10M QPSK(1,24)	0.087	0.048	-0.69	24.06	24.50	0.096	2024/3/01	
Bottom Side	20525/836.5	10M QPSK(1,24)	0.145	0.082	-2.58	24.06	24.50	0.160	2024/3/01	
50%RB										
Front Side	20525/836.5	10M QPSK(25,0)	0.094	0.048	3.73	23.02	23.50	0.105	2024/3/01	
Back Side	20525/836.5	10M QPSK(25,0)	0.137	0.084	-0.59	23.02	23.50	0.153	2024/3/01	
Left Side	20525/836.5	10M QPSK(25,0)	0.050	0.028	4.00	23.02	23.50	0.056	2024/3/01	
Right Side	20525/836.5	10M QPSK(25,0)	0.048	0.025	-4.64	23.02	23.50	0.054	2024/3/01	
Bottom Side	20525/836.5	10M QPSK(25,0)	0.085	0.043	2.66	23.02	23.50	0.095	2024/3/01	

NOTE: Hotspot SAR test results of LTE Band 5

10.1.9. SAR measurement Result of LTE Band 7

Test Position of Head	Test channel /Freq.	Mode	SAR Value (W/kg)		Power Drift(%)	Conducted Power (dBm)	Tune-up Power (dBm)	Scaled SAR 1-g (W/Kg)	Date	Plot
			1-g	10-g						
1RB										
Left Cheek	21100/2535	20M QPSK(1,49)	0.552	0.269	-4.70	24.11	24.50	0.604	2024/3/08	37#

Left Tilt 15 Degree	21100/2535	20M QPSK(1,49)	0.303	0.142	-1.62	24.11	24.50	0.331	2024/3/08	
Right Cheek	21100/2535	20M QPSK(1,49)	0.513	0.237	-2.57	24.11	24.50	0.561	2024/3/08	
Right Tilt 15 Degree	21100/2535	20M QPSK(1,49)	0.278	0.133	3.50	24.11	24.50	0.304	2024/3/08	
50%RB										
Left Cheek	21100/2535	20M QPSK(50,49)	0.300	0.140	-3.66	23.11	23.50	0.328	2024/3/08	
Left Tilt 15 Degree	21100/2535	20M QPSK(50,49)	0.159	0.078	4.23	23.11	23.50	0.174	2024/3/08	
Right Cheek	21100/2535	20M QPSK(50,49)	0.258	0.124	-0.22	23.11	23.50	0.282	2024/3/08	
Right Tilt 15 Degree	21100/2535	20M QPSK(50,49)	0.160	0.068	1.37	23.11	23.50	0.175	2024/3/08	

NOTE: Head SAR test results of LTE Band 7

Test Position of Body-Worn with 10mm	Test channel /Freq.	Mode	SAR Value (W/kg)		Power Drift(%)	Conducted Power (dBm)	Tune-up Power (dBm)	Scaled SAR 1-g (W/Kg)	Date	Plot
			1-g	10-g						
1RB										
Front Side	21100/2535	20M QPSK(1,49)	0.384	0.172	3.94	24.11	24.50	0.420	2024/3/08	
Back Side	21100/2535	20M QPSK(1,49)	0.617	0.285	2.52	24.11	24.50	0.675	2024/3/08	38#
50%RB										
Front Side	21100/2535	20M QPSK(50,49)	0.212	0.090	-3.15	23.11	23.50	0.232	2024/3/08	
Back Side	21100/2535	20M QPSK(50,49)	0.321	0.153	-0.68	23.11	23.50	0.351	2024/3/08	

NOTE: Body-Worn SAR test results of LTE Band 7

Test Position of Hotspot with 10mm	Test channel /Freq.	Mode	SAR Value (W/kg)		Power Drift(%)	Conducted Power (dBm)	Tune-up Power (dBm)	Scaled SAR 1-g (W/Kg)	Date	Plot
			1-g	10-g						
1RB										

Front Side	21100/2535	20M QPSK(1,49)	0.384	0.172	3.94	24.11	24.50	0.420	2024/3/08	
Back Side	21100/2535	20M QPSK(1,49)	0.617	0.285	2.52	24.11	24.50	0.675	2024/3/08	38#
Left Side	21100/2535	20M QPSK(1,49)	0.196	0.093	-2.27	24.11	24.50	0.214	2024/3/08	
Right Side	21100/2535	20M QPSK(1,49)	0.192	0.088	3.61	24.11	24.50	0.210	2024/3/08	
Bottom Side	21100/2535	20M QPSK(1,49)	0.310	0.143	2.38	24.11	24.50	0.339	2024/3/08	
50%RB										
Front Side	21100/2535	20M QPSK(50,49)	0.212	0.090	-3.15	23.11	23.50	0.232	2024/3/08	
Back Side	21100/2535	20M QPSK(50,49)	0.321	0.153	-0.68	23.11	23.50	0.351	2024/3/08	
Left Side	21100/2535	20M QPSK(50,49)	0.109	0.053	-4.37	23.11	23.50	0.119	2024/3/08	
Right Side	21100/2535	20M QPSK(50,49)	0.108	0.051	-2.23	23.11	23.50	0.118	2024/3/08	
Bottom Side	21100/2535	20M QPSK(50,49)	0.181	0.078	4.99	23.11	23.50	0.198	2024/3/08	

NOTE: Hotspot SAR test results of LTE Band 7

10.1.10. SAR measurement Result of LTE Band 12

Test Position of Head	Test channel /Freq.	Mode	SAR Value (W/kg)		Power Drift(%)	Conducted Power (dBm)	Tune-up Power (dBm)	Scaled SAR 1-g (W/Kg)	Date	Plot
			1-g	10-g						
1RB										
Left Cheek	23095/707.5	10M QPSK(1,0)	0.074	0.061	-4.82	23.79	24.00	0.078	2024/3/16	39#
Left Tilt 15 Degree	23095/707.5	10M QPSK(1,0)	0.038	0.030	-2.77	23.79	24.00	0.040	2024/3/16	
Right Cheek	23095/707.5	10M QPSK(1,0)	0.066	0.052	-3.54	23.79	24.00	0.069	2024/3/16	
Right Tilt 15 Degree	23095/707.5	10M QPSK(1,0)	0.036	0.029	-0.94	23.79	24.00	0.038	2024/3/16	

50%RB										
Left Cheek	23095/707.5	10M QPSK(25,24)	0.044	0.034	-2.52	22.85	23.00	0.046	2024/3/16	
Left Tilt 15 Degree	23095/707.5	10M QPSK(25,24)	0.019	0.018	-2.77	22.85	23.00	0.020	2024/3/16	
Right Cheek	23095/707.5	10M QPSK(25,24)	0.034	0.029	4.44	22.85	23.00	0.035	2024/3/16	
Right Tilt 15 Degree	23095/707.5	10M QPSK(25,24)	0.018	0.017	2.11	22.85	23.00	0.019	2024/3/16	

NOTE: Head SAR test results of LTE Band 12

Test Position of Body-Worn with 10mm	Test channel /Freq.	Mode	SAR Value (W/kg)		Power Drift(%)	Conducted Power (dBm)	Tune-up Power (dBm)	Scaled SAR 1-g (W/Kg)	Date	Plot
			1-g	10-g						
1RB										
Front Side	23095/707.5	10M QPSK(1,0)	0.090	0.051	-3.08	23.79	24.00	0.094	2024/3/16	
Back Side	23095/707.5	10M QPSK(1,0)	0.132	0.078	-2.96	23.79	24.00	0.139	2024/3/16	40#
50%RB										
Front Side	23095/707.5	10M QPSK(25,24)	0.052	0.027	0.45	22.85	23.00	0.054	2024/3/16	
Back Side	23095/707.5	10M QPSK(25,24)	0.071	0.045	-2.11	22.85	23.00	0.073	2024/3/16	

NOTE: Body-Worn SAR test results of LTE Band 12

Test Position of Hotspot with 10mm	Test channel /Freq.	Mode	SAR Value (W/kg)		Power Drift(%)	Conducted Power (dBm)	Tune-up Power (dBm)	Scaled SAR 1-g (W/Kg)	Date	Plot
			1-g	10-g						
1RB										
Front Side	23095/707.5	10M QPSK(1,0)	0.090	0.051	-3.08	23.79	24.00	0.094	2024/3/16	
Back Side	23095/707.5	10M QPSK(1,0)	0.132	0.078	-2.96	23.79	24.00	0.139	2024/3/16	40#
Left Side	23095/707.5	10M QPSK(1,0)	0.048	0.030	-0.42	23.79	24.00	0.050	2024/3/16	
Right Side	23095/707.5	10M QPSK(1,0)	0.045	0.026	-2.49	23.79	24.00	0.047	2024/3/16	

Bottom Side	23095/707.5	10M QPSK(1,0)	0.090	0.051	-3.12	23.79	24.00	0.094	2024/3/16	
50%RB										
Front Side	23095/707.5	10M QPSK(25,24)	0.052	0.027	0.45	22.85	23.00	0.054	2024/3/16	
Back Side	23095/707.5	10M QPSK(25,24)	0.071	0.045	-2.11	22.85	23.00	0.073	2024/3/16	
Left Side	23095/707.5	10M QPSK(25,24)	0.027	0.016	-0.15	22.85	23.00	0.028	2024/3/16	
Right Side	23095/707.5	10M QPSK(25,24)	0.024	0.014	3.92	22.85	23.00	0.025	2024/3/16	
Bottom Side	23095/707.5	10M QPSK(25,24)	0.053	0.029	0.96	22.85	23.00	0.055	2024/3/16	

NOTE: Hotspot SAR test results of LTE Band 12

10.1.11. SAR measurement Result of LTE Band 13

Test Position of Head	Test channel /Freq.	Mode	SAR Value (W/kg)		Power Drift(%)	Conducted Power (dBm)	Tune-up Power (dBm)	Scaled SAR 1-g (W/Kg)	Date	Plot
			1-g	10-g						
1RB										
Left Cheek	23230/782	10M QPSK(1,0)	0.015	0.014	1.60	23.79	24.00	0.016	2024/3/16	41#
Left Tilt 15 Degree	23230/782	10M QPSK(1,0)	0.009	0.007	1.94	23.79	24.00	0.009	2024/3/16	
Right Cheek	23230/782	10M QPSK(1,0)	0.013	0.011	-1.75	23.79	24.00	0.014	2024/3/16	
Right Tilt 15 Degree	23230/782	10M QPSK(1,0)	0.006	0.004	0.66	23.79	24.00	0.006	2024/3/16	
50%RB										
Left Cheek	23230/782	10M QPSK(25,24)	0.009	0.008	3.88	22.85	23.00	0.009	2024/3/16	
Left Tilt 15 Degree	23230/782	10M QPSK(25,24)	0.005	0.004	3.67	22.85	23.00	0.005	2024/3/16	
Right Cheek	23230/782	10M QPSK(25,24)	0.007	0.006	-1.81	22.85	23.00	0.007	2024/3/16	

Right Tilt 15 Degree	23230/782	10M QPSK(25,24)	0.003	0.002	-3.32	22.85	23.00	0.003	2024/3/16	
----------------------	-----------	-----------------	-------	-------	-------	-------	-------	-------	-----------	--

NOTE: Head SAR test results of LTE Band 13

Test Position of Body-Worn with 10mm	Test channel /Freq.	Mode	SAR Value (W/kg)		Power Drift(%)	Conducted Power (dBm)	Tune-up Power (dBm)	Scaled SAR 1-g (W/Kg)	Date	Plot
			1-g	10-g						
1RB										
Front Side	23230/782	10M QPSK(1,0)	0.024	0.015	-0.63	23.79	24.00	0.025	2024/3/16	
Back Side	23230/782	10M QPSK(1,0)	0.035	0.023	2.34	23.79	24.00	0.037	2024/3/16	42#
50%RB										
Front Side	23230/782	10M QPSK(25,24)	0.013	0.009	4.13	22.85	23.00	0.013	2024/3/16	
Back Side	23230/782	10M QPSK(25,24)	0.018	0.014	-2.42	22.85	23.00	0.019	2024/3/16	

NOTE: Body-Worn SAR test results of LTE Band 13

Test Position of Hotspot with 10mm	Test channel /Freq.	Mode	SAR Value (W/kg)		Power Drift(%)	Conducted Power (dBm)	Tune-up Power (dBm)	Scaled SAR 1-g (W/Kg)	Date	Plot
			1-g	10-g						
1RB										
Front Side	23230/782	10M QPSK(1,0)	0.024	0.015	-0.63	23.79	24.00	0.025	2024/3/16	
Back Side	23230/782	10M QPSK(1,0)	0.035	0.023	2.34	23.79	24.00	0.037	2024/3/16	42#
Left Side	23230/782	10M QPSK(1,0)	0.020	0.018	-2.33	23.79	24.00	0.021	2024/3/16	
Right Side	23230/782	10M QPSK(1,0)	0.018	0.016	-2.34	23.79	24.00	0.019	2024/3/16	
Bottom Side	23230/782	10M QPSK(1,0)	0.022	0.014	1.47	23.79	24.00	0.023	2024/3/16	
50%RB										
Front Side	23230/782	10M QPSK(25,24)	0.013	0.009	4.13	22.85	23.00	0.013	2024/3/16	
Back Side	23230/782	10M QPSK(25,24)	0.018	0.014	-2.42	22.85	23.00	0.019	2024/3/16	
Left	23230/782	10M	0.011	0.010	-3.37	22.85	23.00	0.011	2024/3/16	

Side		QPSK(25,24)								
Right Side	23230/782	10M QPSK(25,24)	0.009	0.008	-0.38	22.85	23.00	0.009	2024/3/16	
Bottom Side	23230/782	10M QPSK(25,24)	0.012	0.008	4.06	22.85	23.00	0.012	2024/3/16	

NOTE: Hotspot SAR test results of LTE Band 13

10.1.12. SAR measurement Result of LTE Band 17

Test Position of Head	Test channel /Freq.	Mode	SAR Value (W/kg)		Power Drift(%)	Conducted Power (dBm)	Tune-up Power (dBm)	Scaled SAR 1-g (W/Kg)	Date	Plot
			1-g	10-g						
1RB										
Left Cheek	23790/710	10M QPSK(1,0)	0.054	0.045	-4.40	24.21	24.50	0.058	2024/3/16	43#
Left Tilt 15 Degree	23790/710	10M QPSK(1,0)	0.032	0.025	-0.47	24.21	24.50	0.034	2024/3/16	
Right Cheek	23790/710	10M QPSK(1,0)	0.051	0.041	-1.90	24.21	24.50	0.055	2024/3/16	
Right Tilt 15 Degree	23790/710	10M QPSK(1,0)	0.025	0.020	2.71	24.21	24.50	0.027	2024/3/16	
50%RB										
Left Cheek	23790/710	10M QPSK(25,0)	0.029	0.023	3.42	23.14	23.50	0.032	2024/3/16	
Left Tilt 15 Degree	23790/710	10M QPSK(25,0)	0.016	0.013	3.72	23.14	23.50	0.017	2024/3/16	
Right Cheek	23790/710	10M QPSK(25,0)	0.027	0.024	-2.30	23.14	23.50	0.029	2024/3/16	
Right Tilt 15 Degree	23790/710	10M QPSK(25,0)	0.015	0.010	-2.51	23.14	23.50	0.016	2024/3/16	

NOTE: Head SAR test results of LTE Band 17

Test Position of Body-Worn	Test channel /Freq.	Mode	SAR Value (W/kg)		Power Drift(%)	Conducted Power (dBm)	Tune-up Power (dBm)	Scaled SAR 1-g	Date	Plot
			1-g	10-g						

with 10mm								(W/Kg)		
1RB										
Front Side	23790/710	10M QPSK(1,0)	0.066	0.040	-2.01	24.21	24.50	0.071	2024/3/16	
Back Side	23790/710	10M QPSK(1,0)	0.092	0.056	-1.86	24.21	24.50	0.098	2024/3/16	44#
50%RB										
Front Side	23790/710	10M QPSK(25,0)	0.034	0.022	4.55	23.14	23.50	0.037	2024/3/16	
Back Side	23790/710	10M QPSK(25,0)	0.047	0.028	-0.21	23.14	23.50	0.051	2024/3/16	

NOTE: Body-Worn SAR test results of LTE Band 17

Test Position of Hotspot with 10mm	Test channel /Freq.	Mode	SAR Value (W/kg)		Power Drift(%)	Conducted Power (dBm)	Tune-up Power (dBm)	Scaled SAR 1-g (W/Kg)	Date	Plot
			1-g	10-g						
1RB										
Front Side	23790/710	10M QPSK(1,0)	0.066	0.040	-2.01	24.21	24.50	0.071	2024/3/16	
Back Side	23790/710	10M QPSK(1,0)	0.092	0.056	-1.86	24.21	24.50	0.098	2024/3/16	44#
Left Side	23790/710	10M QPSK(1,0)	0.036	0.021	3.43	24.21	24.50	0.038	2024/3/16	
Right Side	23790/710	10M QPSK(1,0)	0.030	0.017	-1.84	24.21	24.50	0.032	2024/3/16	
Bottom Side	23790/710	10M QPSK(1,0)	0.057	0.036	-3.34	24.21	24.50	0.061	2024/3/16	
50%RB										
Front Side	23790/710	10M QPSK(25,0)	0.034	0.022	4.55	23.14	23.50	0.037	2024/3/16	
Back Side	23790/710	10M QPSK(25,0)	0.047	0.028	-0.21	23.14	23.50	0.051	2024/3/16	
Left Side	23790/710	10M QPSK(25,0)	0.021	0.012	1.36	23.14	23.50	0.023	2024/3/16	
Right Side	23790/710	10M QPSK(25,0)	0.016	0.010	-2.07	23.14	23.50	0.017	2024/3/16	
Bottom Side	23790/710	10M QPSK(25,0)	0.029	0.021	-4.57	23.14	23.50	0.032	2024/3/16	

NOTE: Hotspot SAR test results of LTE Band 17

10.1.13. SAR measurement Result of LTE Band 18

Test Position of Head	Test channel /Freq.	Mode	SAR Value (W/kg)		Power Drift(%)	Conducted Power (dBm)	Tune-up Power (dBm)	Scaled SAR 1-g (W/Kg)	Date	Plot
			1-g	10-g						
1RB										
Left Cheek	23925/822.5	15M QPSK(1,0)	0.039	0.034	1.76	23.14	23.50	0.042	2024/3/01	57#
Left Tilt 15 Degree	23925/822.5	15M QPSK(1,0)	0.023	0.019	-2.89	23.14	23.50	0.025	2024/3/01	
Right Cheek	23925/822.5	15M QPSK(1,0)	0.034	0.029	-2.43	23.14	23.50	0.037	2024/3/01	
Right Tilt 15 Degree	23925/822.5	15M QPSK(1,0)	0.017	0.015	-3.91	23.14	23.50	0.018	2024/3/01	
50%RB										
Left Cheek	23925/822.5	15M QPSK(36,37)	0.021	0.018	1.62	22.12	22.50	0.023	2024/3/01	
Left Tilt 15 Degree	23925/822.5	15M QPSK(36,37)	0.013	0.011	2.49	22.12	22.50	0.014	2024/3/01	
Right Cheek	23925/822.5	15M QPSK(36,37)	0.018	0.015	-0.92	22.12	22.50	0.020	2024/3/01	
Right Tilt 15 Degree	23925/822.5	15M QPSK(36,37)	0.009	0.008	2.92	22.12	22.50	0.010	2024/3/01	

NOTE: Head SAR test results of LTE Band 18

Test Position of Body-Worn with 10mm	Test channel /Freq.	Mode	SAR Value (W/kg)		Power Drift(%)	Conducted Power (dBm)	Tune-up Power (dBm)	Scaled SAR 1-g (W/Kg)	Date	Plot
			1-g	10-g						
1RB										
Front Side	23925/822.5	15M QPSK(1,0)	0.060	0.037	-2.02	23.14	23.50	0.065	2024/3/01	
Back Side	23925/822.5	15M QPSK(1,0)	0.098	0.063	-0.90	23.14	23.50	0.106	2024/3/01	58#
50%RB										
Front Side	23925/822.5	15M QPSK(36,37)	0.035	0.019	-0.70	22.12	22.50	0.038	2024/3/01	
Back Side	23925/822.5	15M QPSK(36,37)	0.053	0.037	-3.50	22.12	22.50	0.058	2024/3/01	

NOTE: Body-Worn SAR test results of LTE Band 18

Test Position of Hotspot with 10mm	Test channel /Freq.	Mode	SAR Value (W/kg)		Power Drift(%)	Conducted Power (dBm)	Tune-up Power (dBm)	Scaled SAR 1-g (W/Kg)	Date	Plot
			1-g	10-g						
1RB										
Front Side	23925/822.5	15M QPSK(1,0)	0.060	0.037	-2.02	23.14	23.50	0.065	2024/3/01	
Back Side	23925/822.5	15M QPSK(1,0)	0.098	0.063	-0.90	23.14	23.50	0.106	2024/3/01	58#
Left Side	23925/822.5	15M QPSK(1,0)	0.042	0.027	-2.44	23.14	23.50	0.046	2024/3/01	
Right Side	23925/822.5	15M QPSK(1,0)	0.039	0.025	-1.75	23.14	23.50	0.042	2024/3/01	
Bottom Side	23925/822.5	15M QPSK(1,0)	0.055	0.035	2.18	23.14	23.50	0.060	2024/3/01	
50%RB										
Front Side	23925/822.5	15M QPSK(36,37)	0.035	0.019	-0.70	22.12	22.50	0.038	2024/3/01	
Back Side	23925/822.5	15M QPSK(36,37)	0.053	0.037	-3.50	22.12	22.50	0.058	2024/3/01	
Left Side	23925/822.5	15M QPSK(36,37)	0.022	0.015	-1.15	22.12	22.50	0.024	2024/3/01	
Right Side	23925/822.5	15M QPSK(36,37)	0.020	0.013	-2.80	22.12	22.50	0.022	2024/3/01	
Bottom Side	23925/822.5	15M QPSK(36,37)	0.029	0.020	-2.43	22.12	22.50	0.032	2024/3/01	

NOTE: Hotspot SAR test results of LTE Band 18

10.1.14. SAR measurement Result of LTE Band 19

Test Position of Head	Test channel /Freq.	Mode	SAR Value (W/kg)		Power Drift(%)	Conducted Power (dBm)	Tune-up Power (dBm)	Scaled SAR 1-g (W/Kg)	Date	Plot
			1-g	10-g						
1RB										
Left	24075/837.5	15M QPSK(1,0)	0.045	0.039	-1.35	23.13	23.50	0.049	2024/3/01	55#

Cheek										
Left Tilt 15 Degree	24075/837.5	15M QPSK(1,0)	0.025	0.021	-1.97	23.13	23.50	0.027	2024/3/01	
Right Cheek	24075/837.5	15M QPSK(1,0)	0.041	0.034	3.45	23.13	23.50	0.045	2024/3/01	
Right Tilt 15 Degree	24075/837.5	15M QPSK(1,0)	0.019	0.017	1.10	23.13	23.50	0.021	2024/3/01	
50%RB										
Left Cheek	24075/837.5	15M QPSK(36,0)	0.026	0.023	-4.13	22.13	22.50	0.028	2024/3/01	
Left Tilt 15 Degree	24075/837.5	15M QPSK(36,0)	0.015	0.011	-0.46	22.13	22.50	0.016	2024/3/01	
Right Cheek	24075/837.5	15M QPSK(36,0)	0.024	0.018	0.81	22.13	22.50	0.026	2024/3/01	
Right Tilt 15 Degree	24075/837.5	15M QPSK(36,0)	0.010	0.010	4.03	22.13	22.50	0.011	2024/3/01	

NOTE: Head SAR test results of LTE Band 19

Test Position of Body-Worn with 10mm	Test channel /Freq.	Mode	SAR Value (W/kg)		Power Drift(%)	Conducted Power (dBm)	Tune-up Power (dBm)	Scaled SAR 1-g (W/Kg)	Date	Plot
			1-g	10-g						
1RB										
Front Side	24075/837.5	15M QPSK(1,0)	0.084	0.054	1.60	23.13	23.50	0.091	2024/3/01	
Back Side	24075/837.5	15M QPSK(1,0)	0.127	0.082	-3.41	23.13	23.50	0.138	2024/3/01	56#
50%RB										
Front Side	24075/837.5	15M QPSK(36,0)	0.046	0.030	-1.52	22.13	22.50	0.050	2024/3/01	
Back Side	24075/837.5	15M QPSK(36,0)	0.068	0.046	-1.50	22.13	22.50	0.074	2024/3/01	

NOTE: Body-Worn SAR test results of LTE Band 19

Test Position of Hotspot with 10mm	Test channel /Freq.	Mode	SAR Value (W/kg)		Power Drift(%)	Conducted Power (dBm)	Tune-up Power (dBm)	Scaled SAR 1-g (W/Kg)	Date	Plot
			1-g	10-g						

1RB										
Front Side	24075/837.5	15M QPSK(1,0)	0.084	0.054	1.60	23.13	23.50	0.091	2024/3/01	
Back Side	24075/837.5	15M QPSK(1,0)	0.127	0.082	-3.41	23.13	23.50	0.138	2024/3/01	56#
Left Side	24075/837.5	15M QPSK(1,0)	0.054	0.040	0.30	23.13	23.50	0.059	2024/3/01	
Right Side	24075/837.5	15M QPSK(1,0)	0.051	0.033	0.67	23.13	23.50	0.056	2024/3/01	
Bottom Side	24075/837.5	15M QPSK(1,0)	0.080	0.052	-3.08	23.13	23.50	0.087	2024/3/01	
50%RB										
Front Side	24075/837.5	15M QPSK(36,0)	0.046	0.030	-1.52	22.13	22.50	0.050	2024/3/01	
Back Side	24075/837.5	15M QPSK(36,0)	0.068	0.046	-1.50	22.13	22.50	0.074	2024/3/01	
Left Side	24075/837.5	15M QPSK(36,0)	0.033	0.023	-2.48	22.13	22.50	0.036	2024/3/01	
Right Side	24075/837.5	15M QPSK(36,0)	0.030	0.019	-4.46	22.13	22.50	0.033	2024/3/01	
Bottom Side	24075/837.5	15M QPSK(36,0)	0.047	0.028	4.72	22.13	22.50	0.051	2024/3/01	

NOTE: Hotspot SAR test results of LTE Band 19

10.1.15. SAR measurement Result of LTE Band 25

Test Position of Head	Test channel /Freq.	Mode	SAR Value (W/kg)		Power Drift(%)	Conducted Power (dBm)	Tune-up Power (dBm)	Scaled SAR 1-g (W/Kg)	Date	Plot
			1-g	10-g						
1RB										
Left Cheek	26365/1882.5	20M QPSK(1,0)	0.086	0.057	1.25	23.12	23.50	0.094	2024/3/2	53#
Left Tilt 15 Degree	26365/1882.5	20M QPSK(1,0)	0.047	0.031	3.62	23.12	23.50	0.051	2024/3/2	
Right Cheek	26365/1882.5	20M QPSK(1,0)	0.076	0.049	-1.59	23.12	23.50	0.083	2024/3/2	
Right Tilt 15	26365/1882.5	20M QPSK(1,0)	0.036	0.023	1.77	23.12	23.50	0.039	2024/3/2	

Degree										
50%RB										
Left Cheek	26365/1882.5	20M QPSK(50,0)	0.051	0.033	4.35	22.13	22.50	0.056	2024/3/2	
Left Tilt 15 Degree	26365/1882.5	20M QPSK(50,0)	0.026	0.017	-3.44	22.13	22.50	0.028	2024/3/2	
Right Cheek	26365/1882.5	20M QPSK(50,0)	0.042	0.029	-3.50	22.13	22.50	0.046	2024/3/2	
Right Tilt 15 Degree	26365/1882.5	20M QPSK(50,0)	0.021	0.013	-0.30	22.13	22.50	0.023	2024/3/2	

NOTE: Head SAR test results of LTE Band 25

Test Position of Body-Worn with 10mm	Test channel /Freq.	Mode	SAR Value (W/kg)		Power Drift(%)	Conducted Power (dBm)	Tune-up Power (dBm)	Scaled SAR 1-g (W/Kg)	Date	Plot
			1-g	10-g						
1RB										
Front Side	26365/1882.5	20M QPSK(1,0)	0.300	0.159	-0.87	23.12	23.50	0.327	2024/3/2	
Back Side	26365/1882.5	20M QPSK(1,0)	0.474	0.256	1.44	23.12	23.50	0.517	2024/3/2	54#
50%RB										
Front Side	26365/1882.5	20M QPSK(50,0)	0.174	0.084	-3.93	22.13	22.50	0.189	2024/3/2	
Back Side	26365/1882.5	20M QPSK(50,0)	0.264	0.141	1.05	22.13	22.50	0.287	2024/3/2	

NOTE: Body-Worn SAR test results of LTE Band 25

Test Position of Hotspot with 10mm	Test channel /Freq.	Mode	SAR Value (W/kg)		Power Drift(%)	Conducted Power (dBm)	Tune-up Power (dBm)	Scaled SAR 1-g (W/Kg)	Date	Plot
			1-g	10-g						
1RB										
Front Side	26365/1882.5	20M QPSK(1,0)	0.300	0.159	-0.87	23.12	23.50	0.327	2024/3/2	
Back Side	26365/1882.5	20M QPSK(1,0)	0.474	0.256	1.44	23.12	23.50	0.517	2024/3/2	54#
Left Side	26365/1882.5	20M QPSK(1,0)	0.157	0.085	0.46	23.12	23.50	0.171	2024/3/2	
Right	26365/1882.5	20M	0.153	0.082	3.17	23.12	23.50	0.167	2024/3/2	

Side		QPSK(1,0)								
Bottom Side	26365/1882.5	20M QPSK(1,0)	0.255	0.135	2.74	23.12	23.50	0.278	2024/3/2	
50%RB										
Front Side	26365/1882.5	20M QPSK(50,0)	0.174	0.084	-3.93	22.13	22.50	0.189	2024/3/2	
Back Side	26365/1882.5	20M QPSK(50,0)	0.264	0.141	1.05	22.13	22.50	0.287	2024/3/2	
Left Side	26365/1882.5	20M QPSK(50,0)	0.085	0.050	3.55	22.13	22.50	0.093	2024/3/2	
Right Side	26365/1882.5	20M QPSK(50,0)	0.080	0.047	-4.66	22.13	22.50	0.087	2024/3/2	
Bottom Side	26365/1882.5	20M QPSK(50,0)	0.138	0.073	-4.92	22.13	22.50	0.150	2024/3/2	

NOTE: Hotspot SAR test results of LTE Band 25

10.1.16. SAR measurement Result of LTE Band 38

Test Position of Head	Test channel /Freq.	Mode	SAR Value (W/kg)		Power Drift(%)	Conducted Power (dBm)	Tune-up Power (dBm)	Scaled SAR 1-g (W/Kg)	Date	Plot
			1-g	10-g						
1RB										
Left Cheek	38000/2595	20M QPSK(1,0)	0.327	0.164	0.79	23.57	24.50	0.405	2024/3/08	45#
Left Tilt 15 Degree	38000/2595	20M QPSK(1,0)	0.189	0.092	-3.90	23.57	24.50	0.234	2024/3/08	
Right Cheek	38000/2595	20M QPSK(1,0)	0.283	0.135	-3.44	23.57	24.50	0.351	2024/3/08	
Right Tilt 15 Degree	38000/2595	20M QPSK(1,0)	0.155	0.078	0.56	23.57	24.50	0.192	2024/3/08	
50%RB										
Left Cheek	38000/2595	20M QPSK(50,0)	0.192	0.093	-2.55	22.57	23.50	0.238	2024/3/08	
Left Tilt 15 Degree	38000/2595	20M QPSK(50,0)	0.103	0.047	-3.37	22.57	23.50	0.128	2024/3/08	
Right	38000/2595	20M QPSK(50,0)	0.155	0.069	1.04	22.57	23.50	0.192	2024/3/08	

Cheek										
Right Tilt 15 Degree	38000/2595	20M QPSK(50,0)	0.087	0.045	-3.60	22.57	23.50	0.108	2024/3/08	

NOTE: Head SAR test results of LTE Band 38

Test Position of Body-Worn with 10mm	Test channel /Freq.	Mode	SAR Value (W/kg)		Power Drift(%)	Conducted Power (dBm)	Tune-up Power (dBm)	Scaled SAR 1-g (W/Kg)	Date	Plot
			1-g	10-g						
1RB										
Front Side	38000/2595	20M QPSK(1,0)	0.192	0.095	-0.69	23.57	24.50	0.238	2024/3/08	
Back Side	38000/2595	20M QPSK(1,0)	0.317	0.165	-0.79	23.57	24.50	0.393	2024/3/08	46#
50%RB										
Front Side	38000/2595	20M QPSK(50,0)	0.104	0.055	-4.76	22.57	23.50	0.129	2024/3/08	
Back Side	38000/2595	20M QPSK(50,0)	0.159	0.094	-2.25	22.57	23.50	0.197	2024/3/08	

NOTE: Body-Worn SAR test results of LTE Band 38

Test Position of Hotspot with 10mm	Test channel /Freq.	Mode	SAR Value (W/kg)		Power Drift(%)	Conducted Power (dBm)	Tune-up Power (dBm)	Scaled SAR 1-g (W/Kg)	Date	Plot
			1-g	10-g						
1RB										
Front Side	38000/2595	20M QPSK(1,0)	0.192	0.095	-0.69	23.57	24.50	0.238	2024/3/08	
Back Side	38000/2595	20M QPSK(1,0)	0.317	0.165	-0.79	23.57	24.50	0.393	2024/3/08	46#
Left Side	38000/2595	20M QPSK(1,0)	0.105	0.052	2.13	23.57	24.50	0.130	2024/3/08	
Right Side	38000/2595	20M QPSK(1,0)	0.099	0.051	-0.44	23.57	24.50	0.123	2024/3/08	
Bottom Side	38000/2595	20M QPSK(1,0)	0.170	0.084	-3.23	23.57	24.50	0.211	2024/3/08	
50%RB										
Front Side	38000/2595	20M QPSK(50,0)	0.104	0.055	-4.76	22.57	23.50	0.129	2024/3/08	
Back Side	38000/2595	20M QPSK(50,0)	0.159	0.094	-2.25	22.57	23.50	0.197	2024/3/08	

Left Side	38000/2595	20M QPSK(50,0)	0.058	0.030	2.76	22.57	23.50	0.072	2024/3/08	
Right Side	38000/2595	20M QPSK(50,0)	0.056	0.026	3.48	22.57	23.50	0.069	2024/3/08	
Bottom Side	38000/2595	20M QPSK(50,0)	0.102	0.046	-2.26	22.57	23.50	0.126	2024/3/08	

NOTE: Hotspot SAR test results of LTE Band 38

10.1.17. SAR measurement Result of LTE Band 41

Test Position of Head	Test channel /Freq.	Mode	SAR Value (W/kg)		Power Drift(%)	Conducted Power (dBm)	Tune-up Power (dBm)	Scaled SAR 1-g (W/Kg)	Date	Plot
			1-g	10-g						
1RB										
Left Cheek	40620/2593	20M QPSK(1,49)	0.297	0.150	2.89	25.99	26.00	0.298	2024/3/08	47#
Left Tilt 15 Degree	40620/2593	20M QPSK(1,49)	0.166	0.081	0.80	25.99	26.00	0.166	2024/3/08	
Right Cheek	40620/2593	20M QPSK(1,49)	0.277	0.133	-0.63	25.99	26.00	0.278	2024/3/08	
Right Tilt 15 Degree	40620/2593	20M QPSK(1,49)	0.151	0.074	2.59	25.99	26.00	0.151	2024/3/08	
50%RB										
Left Cheek	40620/2593	20M QPSK(50,24)	0.169	0.077	0.47	24.99	25.00	0.169	2024/3/08	
Left Tilt 15 Degree	40620/2593	20M QPSK(50,24)	0.085	0.045	-1.71	24.99	25.00	0.085	2024/3/08	
Right Cheek	40620/2593	20M QPSK(50,24)	0.158	0.070	-1.17	24.99	25.00	0.158	2024/3/08	
Right Tilt 15 Degree	40620/2593	20M QPSK(50,24)	0.078	0.037	-1.37	24.99	25.00	0.078	2024/3/08	

NOTE: Head SAR test results of LTE Band 41

Test Position of	Test channel	Mode	SAR Value (W/kg)	Power Drift(%)	Conducted Power	Tune-up Power	Scaled SAR	Date	Plot
------------------	--------------	------	------------------	----------------	-----------------	---------------	------------	------	------

Body-Worn with 10mm	/Freq.		1-g	10-g		(dBm)	(dBm)	1-g (W/Kg)		
1RB										
Front Side	40620/2593	20M QPSK(1,49)	0.174	0.091	2.70	25.99	26.00	0.174	2024/3/08	
Back Side	40620/2593	20M QPSK(1,49)	0.282	0.149	-1.84	25.99	26.00	0.283	2024/3/08	48#
50%RB										
Front Side	40620/2593	20M QPSK(50,24)	0.094	0.051	2.79	24.99	25.00	0.094	2024/3/08	
Back Side	40620/2593	20M QPSK(50,24)	0.151	0.079	-1.88	24.99	25.00	0.151	2024/3/08	

NOTE: Body-Worn SAR test results of LTE Band 41

Test Position of Hotspot with 10mm	Test channel /Freq.	Mode	SAR Value (W/kg)		Power Drift(%)	Conducted Power (dBm)	Tune-up Power (dBm)	Scaled SAR 1-g (W/Kg)	Date	Plot
			1-g	10-g						
1RB										
Front Side	40620/2593	20M QPSK(1,49)	0.174	0.091	2.70	25.99	26.00	0.174	2024/3/08	
Back Side	40620/2593	20M QPSK(1,49)	0.282	0.149	-1.84	25.99	26.00	0.283	2024/3/08	48#
Left Side	40620/2593	20M QPSK(1,49)	0.096	0.054	-0.83	25.99	26.00	0.096	2024/3/08	
Right Side	40620/2593	20M QPSK(1,49)	0.093	0.049	2.82	25.99	26.00	0.093	2024/3/08	
Bottom Side	40620/2593	20M QPSK(1,49)	0.160	0.080	3.86	25.99	26.00	0.160	2024/3/08	
50%RB										
Front Side	40620/2593	20M QPSK(50,24)	0.094	0.051	2.79	24.99	25.00	0.094	2024/3/08	
Back Side	40620/2593	20M QPSK(50,24)	0.151	0.079	-1.88	24.99	25.00	0.151	2024/3/08	
Left Side	40620/2593	20M QPSK(50,24)	0.059	0.031	-3.38	24.99	25.00	0.059	2024/3/08	
Right Side	40620/2593	20M QPSK(50,24)	0.056	0.029	-4.63	24.99	25.00	0.056	2024/3/08	
Bottom Side	40620/2593	20M QPSK(50,24)	0.085	0.041	-2.61	24.99	25.00	0.085	2024/3/08	

NOTE: Hotspot SAR test results of LTE Band 41

10.1.18. SAR measurement Result of NR n38

Test Position of Head	Test channel /Freq.	Mode	SAR Value (W/kg)		Power Drift(%)	Conducted Power (dBm)	Tune-up Power (dBm)	Scaled SAR 1-g (W/Kg)	Date	Plot
			1-g	10-g						
Left Cheek	519000/2595	30kHz 40M QPSK(1,1)	0.533	0.249	0.29	23.75	24.50	0.633	2024/3/08	51#
Left Tilt 15 Degree	519000/2595	30kHz 40M QPSK(1,1)	0.273	0.121	2.87	23.75	24.50	0.324	2024/3/08	
Right Cheek	519000/2595	30kHz 40M QPSK(1,1)	0.486	0.218	2.93	23.75	24.50	0.578	2024/3/08	
Right Tilt 15 Degree	519000/2595	30kHz 40M QPSK(1,1)	0.226	0.103	-1.51	23.75	24.50	0.269	2024/3/08	

NOTE: Head SAR test results of NR n38

Test Position of Body-Worn with 10mm	Test channel /Freq.	Mode	SAR Value (W/kg)		Power Drift(%)	Conducted Power (dBm)	Tune-up Power (dBm)	Scaled SAR 1-g (W/Kg)	Date	Plot
			1-g	10-g						
Front Side	519000/2595	30kHz 40M QPSK(1,1)	0.234	0.124	2.27	23.75	24.50	0.278	2024/3/08	
Back Side	519000/2595	30kHz 40M QPSK(1,1)	0.346	0.177	-1.03	23.75	24.50	0.411	2024/3/08	52#

NOTE: Body-Worn SAR test results of NR n38

Test Position of Hotspot with 10mm	Test channel /Freq.	Mode	SAR Value (W/kg)		Power Drift(%)	Conducted Power (dBm)	Tune-up Power (dBm)	Scaled SAR 1-g (W/Kg)	Date	Plot
			1-g	10-g						
Front Side	519000/2595	30kHz 40M QPSK(1,1)	0.234	0.124	2.27	23.75	24.50	0.278	2024/3/08	
Back Side	519000/2595	30kHz 40M QPSK(1,1)	0.346	0.177	-1.03	23.75	24.50	0.411	2024/3/08	52#
Left Side	519000/2595	30kHz 40M QPSK(1,1)	0.117	0.059	3.42	23.75	24.50	0.139	2024/3/08	
Right Side	519000/2595	30kHz 40M QPSK(1,1)	0.114	0.058	2.07	23.75	24.50	0.135	2024/3/08	