



FCC Radio Test Report

FCC ID: 2A8TU-Y168

Report No. : TBR-C-202205-0291-30
Applicant : Shenzhen Forever Young Technology Co.,Ltd
Equipment Under Test (EUT)
EUT Name : Wi-Fi IR+RF Remote Control
Model No. : S11
Series Model No. : S12, UR01, S11Pro, S19RF, S20RF, S25RF
Brand Name : Zitech, UniMaison
Sample ID : 202205-0291-1-1-1#& 202205-0291-1-2#
Receipt Date : 2022-06-23
Test Date : 2022-06-23 to 2022-07-12
Issue Date : 2022-09-27
Standards : FCC Part 15, Subpart C (15.231(a))
Test Method : ANSI C63.10:2013
Conclusions : **PASS**

In the configuration tested, the EUT complied with the standards specified above,

The EUT technically complies with the FCC requirements

Test/Witness Engineer :  Seven Wu

Engineer Supervisor :  Ivan Su

Engineer Manager :  Ray Lai



This report details the results of the testing carried out on one sample. The results contained in this test report do not relate to other samples of the same product. The manufacturer should ensure that all products in series production are in conformity with the product sample detailed in the report.

Contents

CONTENTS..... 2

1. GENERAL INFORMATION ABOUT EUT 5

1.1 Client Information..... 5

1.2 General Description of EUT (Equipment Under Test) 5

1.3 Block Diagram Showing the Configuration of System Tested..... 6

1.4 Description of Support Units 6

1.5 Description of Test Mode..... 6

1.6 Description of Test Software Setting..... 7

1.7 Measurement Uncertainty..... 7

1.8 Test Facility 8

2. TEST SUMMARY 8

3. TEST SOFTWARE..... 8

4. TEST EQUIPMENT..... 9

5. CONDUCTED EMISSION TEST 10

5.1 Test Standard and Limit..... 10

5.2 Test Setup..... 10

5.3 Test Procedure..... 11

5.4 Deviation From Test Standard..... 11

5.5 Test Data..... 11

6. RADIATED EMISSION TEST 12

6.1 Test Standard and Limit..... 12

6.2 Test Setup..... 13

6.3 Test Procedure..... 15

6.4 Deviation From Test Standard..... 15

6.5 EUT Operating Condition 15

6.6 Test Data..... 15

7. BANDWIDTH 16

7.1 Test Standard and Limit..... 16

7.2 Test Setup..... 16

7.3 Test Procedure..... 16

7.4 Deviation From Test Standard..... 16

7.5 EUT Operating Condition 16

7.6 Test Data..... 16

8. RELEASE TIME MEASUREMENT 17

8.1 Test Standard and Limit..... 17

8.2 Test Setup..... 17

8.3 Test Procedure..... 17

8.4 Deviation From Test Standard..... 17

8.5 EUT Operating Condition 17

8.6 Test Data.....	17
9. DUTY CYCLE	18
9.1 Test Standard and Limit.....	18
9.2 Test Setup.....	18
9.3 Test Procedure.....	18
9.4 Deviation From Test Standard.....	18
9.5 EUT Operating Condition	18
9.6 Test Data.....	18
10. ANTENNA REQUIREMENT.....	19
10.1 Standard Requirement.....	19
10.1 Deviation From Test Standard.....	19
10.2 Antenna Connected Construction.....	19
ATTACHMENT A--CONDUCTED EMISSION TEST DATA	20
ATTACHMENT B-- RADIATED EMISSION TEST DATA	22
ATTACHMENT C--BANDWIDTH DATA	27
ATTACHMENT D-- RELEASE TIME MEASUREMENT DATA.....	28
ATTACHMENT E--DUTY CYCLE DATA.....	29

1. General Information about EUT

1.1 Client Information

Applicant	:	Shenzhen Forever Young Technology Co.,Ltd
Address	:	2/F, No B2 Bldg, Fuyuan Industrial Park, Fu yong Town, Bao'an District, Shenzhen, China
Manufacturer	:	Shenzhen Forever Young Technology Co.,Ltd
Address	:	2/F, No B2 Bldg, Fuyuan Industrial Park, Fu yong Town, Bao'an District, Shenzhen, China

1.2 General Description of EUT (Equipment Under Test)

EUT Name	:	Wi-Fi IR+RF Remote Control	
Models No.	:	S11, S12, UR01, S11Pro, S19RF, S20RF, S25RF	
Model Difference	:	All PCB boards and circuit diagrams are the same, the only difference is that appearance.	
Product Description	:	Operation Frequency:	433.92 MHz
	:	Output Power:	66.48 dBuV/m (PK Max.) 57.92 dBuV/m (AV Max.)
	:	Antenna Gain:	FPC Antenna(-7.25 dBi)
	:	Modulation Type:	OOK
Power Rating	:	Input: DC 5V/1A	
Software Version	:	V2.0.8	
Hardware Version	:	V2.4	
Remark	:	The antenna gain provided by the applicant, the verified for the RF conduction test provided by TOBY test lab.	

Note:

- (1) For a more detailed features description, please refer to the manufacturer's specifications or the User's Manual.

1.3 Block Diagram Showing the Configuration of System Tested

TX Mode

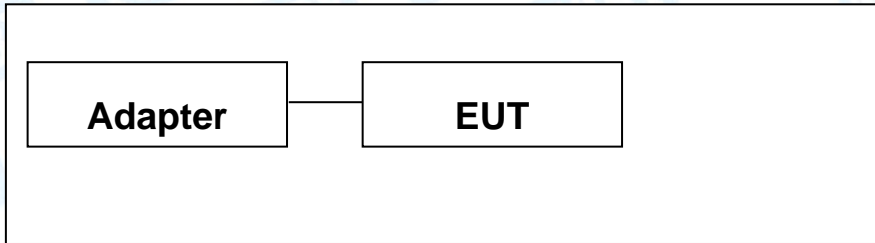

1.4 Description of Support Units

The EUT has been test as an independent unit.

1.5 Description of Test Mode

To investigate the maximum EMI emission characteristics generates from EUT, the test system was pre-scanning tested base on the consideration of following EUT operation mode or test configuration mode which possible have effect on EMI emission level. Each of these EUT operation mode(s) or test configuration mode(s) mentioned follow was evaluated respectively.

Test Items	Note
Conducted Emission	Normal Mode
Radiated Emission	Continuously transmitting
Bandwidth	Continuously transmitting
Duty Cycle	Continuously transmitting
Release Time	Normal Mode

Note:

- (1) During the testing procedure, the continuously transmitting mode was programmed by the customer.
- (2) The EUT is considered a Mobile unit, and it was pre-tested on the positioned of each 3 axis: X axis, Y axis and Z axis. The worst case was found positioned on Z-plane. There for only the test data of this Z-plane were used for radiated emission measurement test.

1.6 Description of Test Software Setting

During testing channel & Power controlling software provided by the customer was used to control the operating channel as well as the output power level. The RF output power selection is for the setting of RF output power expected by the customer and is going to be fixed on the firmware of the final end product power parameters of transmitting mode.

RF Power Setting in Test SW:	DEF
-------------------------------------	-----

1.7 Measurement Uncertainty

The reported uncertainty of measurement $y \pm U$, where expanded uncertainty U is based on a standard uncertainty multiplied by a coverage factor of $k=2$, providing a level of confidence of approximately 95 %.

Test Item	Parameters	Expanded Uncertainty (U_{Lab})
Conducted Emission	Level Accuracy: 9kHz~150kHz 150kHz to 30MHz	± 3.50 dB ± 3.10 dB
Radiated Emission	Level Accuracy: 9kHz to 30 MHz	± 4.60 dB
Radiated Emission	Level Accuracy: 30MHz to 1000 MHz	± 4.20 dB
Radiated Emission	Level Accuracy: Above 1000MHz	± 4.20 dB

1.8 Test Facility

The testing was performed by the Shenzhen Toby Technology Co., Ltd., in their facilities located at: 1/F., Building 6, Rundongsheng Industrial Zone, Longzhu, Xixiang, Bao'an, Shenzhen, Guangdong, China.

At the time of testing, the following bodies accredited the Laboratory:

CNAS (L5813)

The Laboratory has been accredited by CNAS to ISO/IEC 17025: 2017 General Requirements for the Competence of Testing and Calibration Laboratories for the competence in the field of testing. And the Registration No.: CNAS L5813.

A2LA Certificate No.: 4750.01

The laboratory has been accredited by American Association for Laboratory Accreditation(A2LA) to ISO/IEC 17025: 2017 General Requirements for the Competence of Testing and Calibration Laboratories for the technical competence in the field of Electrical Testing. And the A2LA Certificate No.: 4750.01.FCC Accredited Test Site Number: 854351. Designation Number:CN1223.

IC Registration No.: (11950A-1)

The Laboratory has been registered by Certification and Engineering Bureau of Industry Canada for radio equipment testing. The site registration: Site# 11950A-1.

2. Test Summary

FCC Part 15 Subpart (15.231(a))				
Standard Section	Test Item	Test Sample(s)	Judgment	Remark
FCC				
15.203	Antenna Requirement	202205-0291-1-1#	PASS	N/A
15.207	Conducted Emission	202205-0291-1-2#	N/A	N/A
15.231	Release Time	202205-0291-1-1#	PASS	N/A
	Radiation Emission	202205-0291-1-2#	PASS	N/A
	20 dB Bandwidth	202205-0291-1-1#	PASS	N/A
	Duty Cycle	202205-0291-1-1#	PASS	N/A
Note: N/A is an abbreviation for Not Applicable.				

3. Test Software

Test Item	Test Software	Manufacturer	Version No.
Conducted Emission	EZ-EMC	EZ	CDI-03A2
Radiation Emission	EZ-EMC	EZ	FA-03A2RE

4. Test Equipment

Conducted Emission Test					
Equipment	Manufacturer	Model No.	Serial No.	Last Cal.	Cal. Due Date
EMI Test Receiver	Rohde & Schwarz	ESCI	100321	Jun. 23, 2022	Jun. 22, 2023
RF Switching Unit	Compliance Direction Systems Inc	RSU-A4	34403	Jun. 23, 2022	Jun. 22, 2023
AMN	SCHWARZBECK	NNBL 8226-2	8226-2/164	Jun. 22, 2022	Jun. 21, 2023
LISN	Rohde & Schwarz	ENV216	101131	Jun. 22, 2022	Jun. 21, 2023
Radiation Emission Test (A Site)					
Equipment	Manufacturer	Model No.	Serial No.	Last Cal.	Cal. Due Date
Spectrum Analyzer	Rohde & Schwarz	FSV40-N	102197	Jun. 23, 2022	Jun. 22, 2023
EMI Test Receiver	Rohde & Schwarz	ESPI	100010/007	Jun. 23, 2022	Jun. 22, 2023
Bilog Antenna	ETS-LINDGREN	3142E	00117537	Feb. 27, 2022	Feb.26, 2024
Horn Antenna	ETS-LINDGREN	3117	00143207	Feb. 26, 2022	Feb.25, 2024
Horn Antenna	SCHWARZBECK	BBHA 9170	1118	Feb. 26, 2022	Feb.25, 2024
Loop Antenna	SCHWARZBECK	FMZB 1519 B	1519B-059	Feb. 26, 2022	Feb.25, 2024
Pre-amplifier	SONOMA	310N	185903	Feb. 26, 2022	Feb.25, 2023
Pre-amplifier	HP	8449B	3008A00849	Feb. 26, 2022	Feb.25, 2023
HF Amplifier	Tonscend	TAP0184050	AP21C806129	Sep. 03, 2021	Sep. 02, 2022
Radiation Emission Test (B Site)					
Equipment	Manufacturer	Model No.	Serial No.	Last Cal.	Cal. Due Date
Spectrum Analyzer	Rohde & Schwarz	FSV40-N	102197	Jun. 23, 2022	Jun. 22, 2023
MXA Signal Analyzer	Agilent	N9020A	MY47380425	Sep. 03, 2021	Sep. 02, 2022
EMI Test Receiver	Rohde & Schwarz	ESU-8	100472	Feb. 26, 2022	Feb.25, 2023
Bilog Antenna	SCHWARZBECK	VULB 9168	1225	Dec. 05, 2021	Dec. 04, 2023
Horn Antenna	SCHWARZBECK	BBHA 9120 D	2463	Feb. 26, 2022	Feb.25, 2024
Horn Antenna	SCHWARZBECK	BBHA 9170	1118	Jun. 26, 2022	Jun.25, 2024
Loop Antenna	SCHWARZBECK	FMZB 1519 B	1519B-059	Jun. 26, 2022	Jun.25, 2024
HF Amplifier	Tonscend	TAP9E6343	AP21C806117	Sep. 03, 2021	Sep. 02, 2022
HF Amplifier	Tonscend	TAP051845	AP21C806141	Sep. 03, 2021	Sep. 02, 2022
HF Amplifier	Tonscend	TAP0184050	AP21C806129	Sep. 03, 2021	Sep. 02, 2022
Antenna Conducted Emission					
Equipment	Manufacturer	Model No.	Serial No.	Last Cal.	Cal. Due Date
Spectrum Analyzer	Agilent	E4407B	MY45106456	Jun. 23, 2022	Jun. 22, 2023
Spectrum Analyzer	Rohde & Schwarz	FSV40-N	102197	Jun. 23, 2022	Jun. 22, 2023
MXA Signal Analyzer	Agilent	N9020A	MY49100060	Sep. 03, 2021	Sep. 02, 2022
Spectrum Analyzer	KEYSIGT	N9020B	MY60110172	Sep. 03, 2021	Sep. 02, 2022
RF Power Sensor	DARE!! Instruments	RadiPowerRPR3006W	17I00015SNO26	Sep. 03, 2021	Sep. 02, 2022
	DARE!! Instruments	RadiPowerRPR3006W	17I00015SNO29	Sep. 03, 2021	Sep. 02, 2022
	DARE!! Instruments	RadiPowerRPR3006W	17I00015SNO31	Sep. 03, 2021	Sep. 02, 2022
	DARE!! Instruments	RadiPowerRPR3006W	17I00015SNO33	Sep. 03, 2021	Sep. 02, 2022
RF Control Unit	Tonsced	JS0806-2	21F8060439	Sep. 03, 2021	Sep. 02, 2022

5. Conducted Emission Test

5.1 Test Standard and Limit

5.1.1 Test Standard
FCC 15.207

5.1.2 Test Limit

Conducted Emission Test Limit

Frequency	Maximum RF Line Voltage (dB μ V)	
	Quasi-peak Level	Average Level
150kHz~500kHz	66 ~ 56 *	56 ~ 46 *
500kHz~5MHz	56	46
5MHz~30MHz	60	50

Notes:

- (1) *Decreasing linearly with logarithm of the frequency.
- (2) The lower limit shall apply at the transition frequencies.
- (3) The limit decrease in line with the logarithm of the frequency in the range of 0.15 to 0.50MHz.

5.2 Test Setup

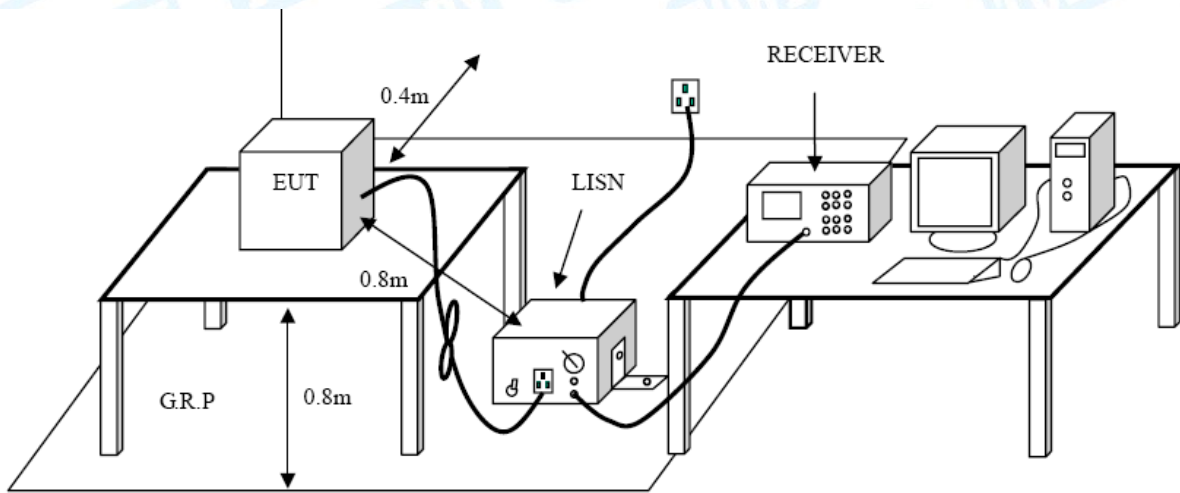

5.3 Test Procedure

The EUT was placed 0.8 meters from the horizontal ground plane with EUT being connected to the power mains through a line impedance stabilization network (LISN). All other support equipments powered from additional LISN(s). The LISN provide 50 Ohm/50uH of coupling impedance for the measuring instrument.

The EUT must be tested for all available U.S. voltages and frequencies (such as a nominal 120 VAC, 50/60 Hz and 240 VAC, 50/60 Hz) for which the device is capable of operation.

Interconnecting cables that hang closer than 40 cm to the ground plane shall be folded back and forth in the center forming a bundle 30 to 40 cm long.

I/O cables that are not connected to a peripheral shall be bundled in the center. The end of the cable may be terminated, if required, using the correct terminating impedance. The overall length shall not exceed 1 m.

LISN at least 80 cm from nearest part of EUT chassis.

The bandwidth of EMI test receiver is set at 9kHz, and the test frequency band is from 0.15MHz to 30MHz.

5.4 Deviation From Test Standard

No deviation

5.5 Test Data

Please refer to the Attachment A.

6. Radiated Emission Test

6.1 Test Standard and Limit

6.1.1 Test Standard

FCC 15.231

6.1.2 Test Limit

According to FCC 15.231(a) requirement:

In addition to the provisions of Section 15.205, the field strength of emissions from intentional radiators operated under this Section shall not exceed the following:

Fundamental Frequency (MHz)	Field Strength of Fundamental (microvolt/meter) at 3m	Field Strength of Spurious Emissions (microvolt/meter) at 3m
40.66~40.70	2250	225
70~130	1250	125
130~174	1250 to 3750(**)	125 to 375(**)
174~260	3750	375
260~470	3750 to 12500(**)	375 to 1250(**)
Above 470	12500	1250

** Linear interpolations, the formulas for calculating the maximum permitted fundamental field strengths are as follows:

- (1) for the band 130~174 MHz, $\mu\text{V/m}$ at 3 meters= $56.81818(F)-6136.3636$;
- (2) for the band 260~470 MHz, $\mu\text{V/m}$ at 3 meter= $41.6667(F)-7083.3333$.
- (3) The maximum permitted unwanted emissions level is 20 dB below the maximum permitted fundamental level. In addition field strength of any emissions which appear inside of the restriction band shall not exceed the general radiated emissions limits in FCC Part15.209.

Frequency (MHz)	Field Strength (microvolt/meter)	Measurement Distance (meters)
0.009~0.490	$2400/F(\text{KHz})$	300
0.490~1.705	$24000/F(\text{KHz})$	30
1.705~30.0	30	30
30~88	100	3
88~216	150	3
216~960	200	3
Above 960	500	3

Note:

- (1) The tighter limit applies at the band edges.
- (2) For above 30MHz:
Emission Level(dBuV/m)=20log Emission Level(uV/m)
- For 0.009~0.490MHz:
Emission Level(dBuV/m)=20log Emission Level(uV/m) +40log(300/3)
- For 0.049~30MHz:
Emission Level(dBuV/m)=20log Emission Level(uV/m) +40log(30/3)

So the field strength of emission limits have been calculated in below table.

Fundamental Frequency (MHz)	Field Strength of Fundamental (microvolt/meter) at 3m
433.92 MHz	80.82 (Average)
433.92 MHz	100.82 (Peak)

6.2 Test Setup

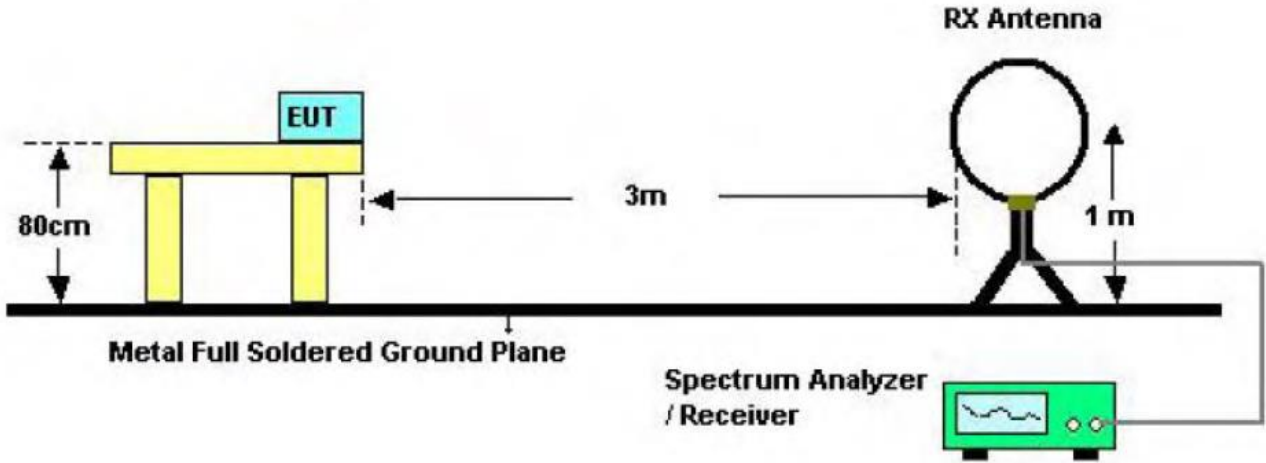

Below 30MHz Test Setup

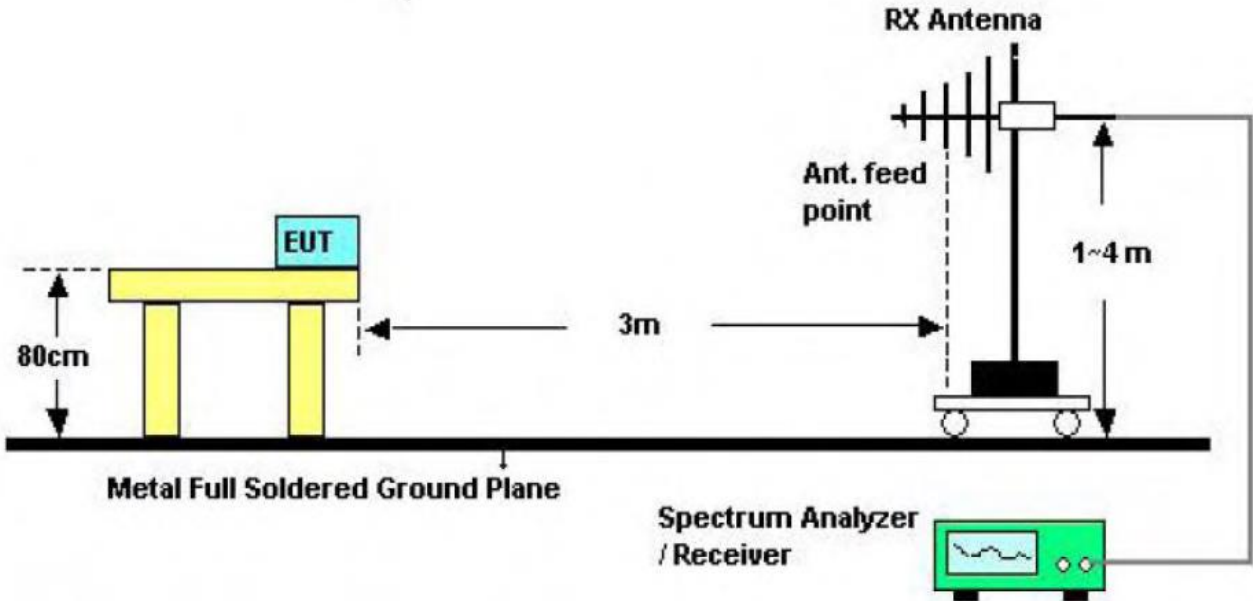

Bellow 1000MHz Test Setup

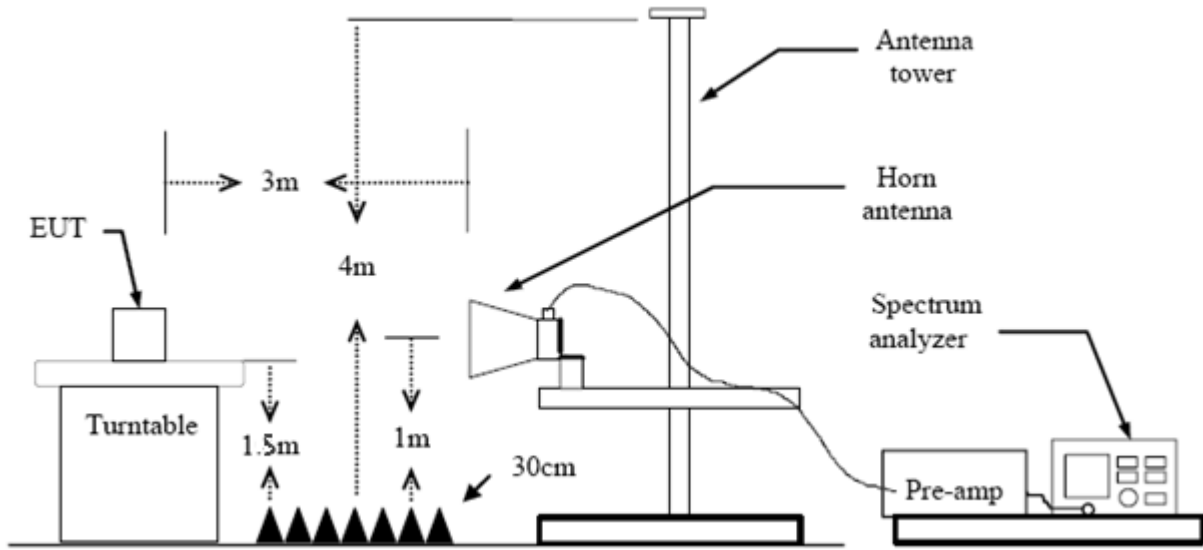

Above 1GHz Test Setup

6.3 Test Procedure

- (1) The measuring distance of 3m shall be used for measurements at frequency up to 1GHz. The EUT was placed on a rotating 0.8m high above the ground, the table was rotated 360 degrees to determine the position of the highest radiation.
- (2) Measurements at frequency above 1GHz. The EUT was placed on a rotating 1.5m high above the ground. RF absorbers covered the ground plane with a minimum area of 3.0m by 3.0m between the EUT and measurement receiver antenna. The RF absorber shall not exceed 30cm in high above the conducting floor. The table was rotated 360 degrees to determine the position of the highest radiation.
- (3) The Test antenna shall vary between 1m and 4m, Both Horizontal and Vertical antenna are set to make measurement.
- (4) The initial step in collecting conducted emission data is a spectrum analyzer peak detector mode pre-scanning the measurement frequency range. Significant peaks are then marked and then Quasi Peak detector mode re-measured.
- (5) If the Peak Mode measured value compliance with and lower than Quasi Peak Mode Limit Bellow 1 GHz, the EUT shall be deemed to meet QP Limits and then no additional QP Mode measurement performed. But the Peak Value and average value both need to comply with applicable limit above 1 GHz.
- (6) Testing frequency range below 1GHz the measuring instrument use VBW=120 kHz with Quasi-peak detection.
- (7) Testing frequency range above 1GHz the measuring instrument use RBW=1 MHz and VBW=3 MHz with Peak Detector for Peak Values, and use RBW=1 MHz and VBW=10 Hz with Peak Detector for Average Values.
- (8) For the actual test configuration, please see the test setup photo.

6.4 Deviation From Test Standard

No deviation

6.5 EUT Operating Condition

The Equipment Under Test was set to Continual Transmitting in maximum power.

6.6 Test Data

Please refer to the Attachment B.

7. Bandwidth

7.1 Test Standard and Limit

7.1.1 Test Standard
FCC 15.231

7.1.2 Test Limit

The 99% bandwidth of the emissions shall be no wider than 0.25% of the center frequency for devices operating above 70 MHz and below 900 MHz. So the emission bandwidth limits have been calculated in below table.

Fundamental Frequency	20 dB Bandwidth Limits (MHz)
433.92MHz	1.0848

7.2 Test Setup

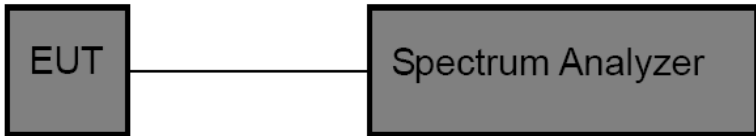

7.3 Test Procedure

- (1) Set Spectrum Analyzer Center Frequency= Fundamental Frequency, RBW=10 kHz, VBW=30 kHz, Span= 1 MHz.
- (2) Measured the spectrum width with power higher than 20 dB below carrier.

7.4 Deviation From Test Standard

No deviation

7.5 EUT Operating Condition

The Equipment Under Test was Programmed to be in continuously transmitting mode.

7.6 Test Data

Please refer to the Attachment C.

8. Release Time Measurement

8.1 Test Standard and Limit

8.1.1 Test Standard

FCC 15.231

8.1.2 Test Limit

According to FCC 15.231a, A manually operated transmitter shall employ a switch that will automatically deactivate the transmitter within not more than 5 seconds of being released.

8.2 Test Setup

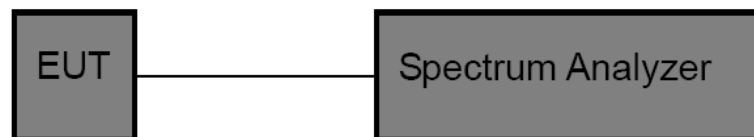

8.3 Test Procedure

- (1) Setup the EUT as show in the block diagram above.
- (2) Set Spectrum Analyzer Centre Frequency= Fundamental Frequency, RBW=100 kHz, VBW= 300 kHz, Span= 0 Hz. Sweep Time= 5 Seconds.
- (3) Setup the EUT as normal operation and press Transmitter button.
- (4) Set Spectrum Analyzer View, Delta Mark time.

8.4 Deviation From Test Standard

No deviation

8.5 EUT Operating Condition

The EUT was set to work in transmitting mode.

8.6 Test Data

Please refer to the Attachment D.

9. Duty Cycle

9.1 Test Standard and Limit

9.1.1 Test Standard
FCC 15.231

9.2 Test Setup

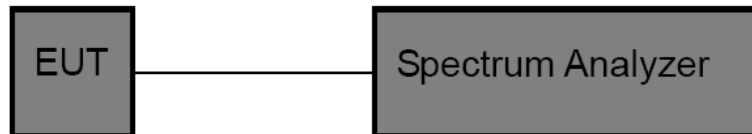

9.3 Test Procedure

- (1) The EUT was placed on a turntable which is 0.8m above ground plane.
- (2) Set EUT operating in continuous transmitting mode.
- (3) Set the Spectrum Analyzer to the transmitter carrier frequency, and set the spectrum analyzer resolution bandwidth (RBW) to 100 kHz and video bandwidth (VBW) to 300 kHz, Span was set to 0 Hz.
- (4) The Duty Cycle was measured and recorded.

9.4 Deviation From Test Standard

No deviation

9.5 EUT Operating Condition

The EUT was programmed to be in transmitting mode.

9.6 Test Data

Please refer to the Attachment E.

10. Antenna Requirement

10.1 Standard Requirement

10.1.1 Standard

FCC Part 15.203

10.1.2 Requirement

An intentional radiator shall be designed to ensure that no antenna other than that furnished by the responsible party shall be used with the device. The use of a permanently attached antenna or of an antenna that uses a unique coupling to the intentional radiator shall be considered sufficient to comply with the provisions of this Section. The manufacturer may design the unit so that a broken antenna can be replaced by the user, but the use of a standard antenna jack or electrical connector is prohibited.

10.1 Deviation From Test Standard

No deviation

10.2 Antenna Connected Construction

The gains of the antenna used for transmitting is -7.25 dBi, and the antenna connector is de-signed with permanent attachment and no consideration of replacement. Please see the EUT photo for details.

The EUT antenna is an FPC Antenna. It complies with the standard requirement.

Antenna Type
<input checked="" type="checkbox"/> Permanent attached antenna
<input type="checkbox"/> Unique connector antenna
<input type="checkbox"/> Professional installation antenna

Attachment A--Conducted Emission Test Data

Temperature:	24.4°C	Relative Humidity:	44%
Test Voltage:	AC 120V/60Hz		
Terminal:	Line		
Test Mode:	Mode 1		
Remark:	Only worse case is reported.		

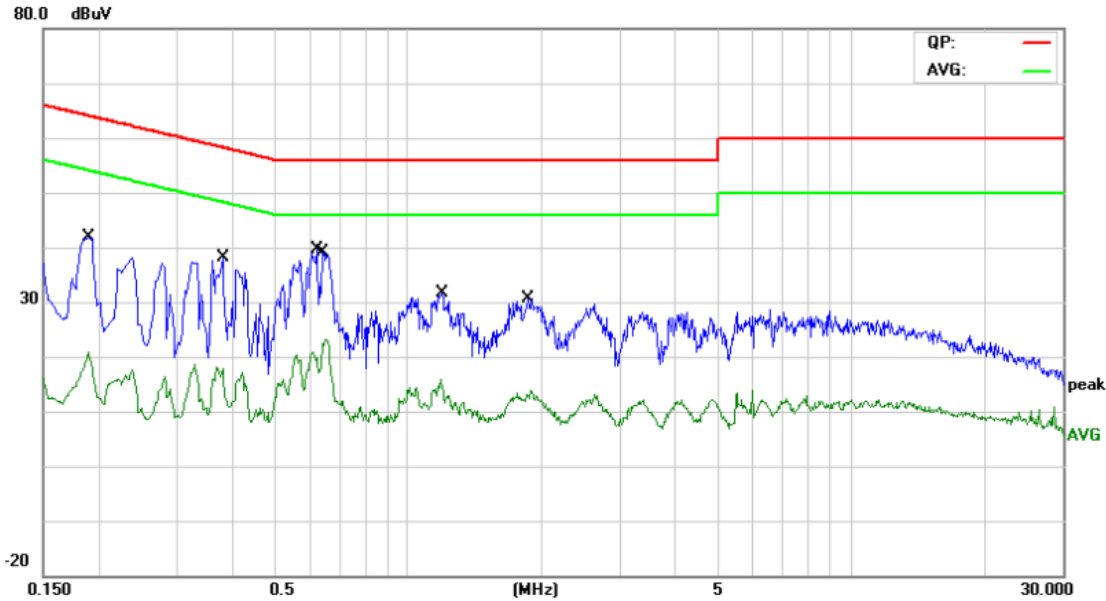

No.	Mk.	Freq. MHz	Reading Level dBuV	Correct Factor dB	Measure- ment dBuV	Limit dBuV	Over dB	Detector
1		0.1900	24.96	11.02	35.98	64.03	-28.05	QP
2		0.1900	6.17	11.02	17.19	54.03	-36.84	AVG
3		0.3820	19.15	10.89	30.04	58.23	-28.19	QP
4		0.3820	4.17	10.89	15.06	48.23	-33.17	AVG
5		0.6220	21.95	10.91	32.86	56.00	-23.14	QP
6		0.6220	8.68	10.91	19.59	46.00	-26.41	AVG
7	*	0.6419	23.00	10.90	33.90	56.00	-22.10	QP
8		0.6419	9.97	10.90	20.87	46.00	-25.13	AVG
9		1.1940	14.43	10.65	25.08	56.00	-30.92	QP
10		1.1940	3.40	10.65	14.05	46.00	-31.95	AVG
11		1.8660	11.76	10.52	22.28	56.00	-33.72	QP
12		1.8660	1.29	10.52	11.81	46.00	-34.19	AVG

- Remark:
1. Corr. Factor (dB) = LISN Factor (dB) + Cable Loss (dB)
 2. Margin (dB) = QuasiPeak/Average (dBuV) - Limit (dBuV)

Temperature:	24.4°C	Relative Humidity:	44%
Test Voltage:	AC 120V/60Hz		
Terminal:	Neutral		
Test Mode:	Mode 1		
Remark:	Only worse case is reported.		

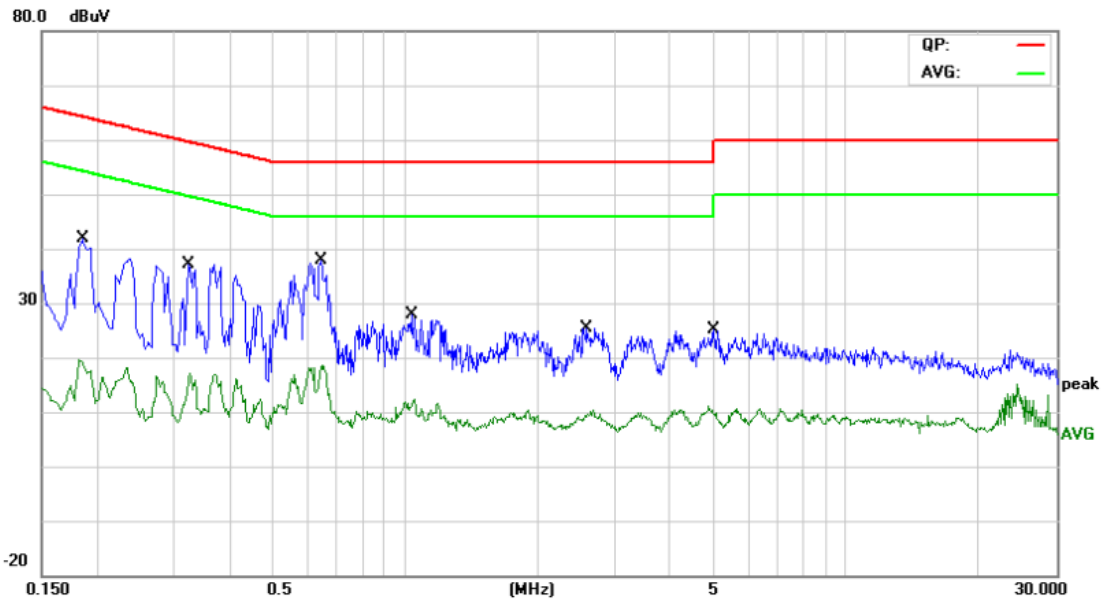

No.	Mk.	Freq.	Reading Level	Correct Factor	Measurement	Limit	Over	
		MHz	dBuV	dB	dBuV	dBuV	dB	Detector
1		0.1860	25.58	11.08	36.66	64.21	-27.55	QP
2		0.1860	6.92	11.08	18.00	54.21	-36.21	AVG
3		0.3220	19.15	10.96	30.11	59.65	-29.54	QP
4		0.3220	3.37	10.96	14.33	49.65	-35.32	AVG
5	*	0.6460	19.67	10.88	30.55	56.00	-25.45	QP
6		0.6460	5.91	10.88	16.79	46.00	-29.21	AVG
7		1.0339	9.28	10.69	19.97	56.00	-36.03	QP
8		1.0339	-0.33	10.69	10.36	46.00	-35.64	AVG
9		2.5940	5.91	10.33	16.24	56.00	-39.76	QP
10		2.5940	-2.11	10.33	8.22	46.00	-37.78	AVG
11		5.0300	5.54	10.04	15.58	60.00	-44.42	QP
12		5.0300	-1.14	10.04	8.90	50.00	-41.10	AVG

Remark:
 1. Corr. Factor (dB) = LISN Factor (dB) + Cable Loss (dB)
 2. Margin (dB) = QuasiPeak/Average (dBuV) - Limit (dBuV)

Attachment B-- Radiated Emission Test Data

9 KHz to 30 MHz

From 9 KHz to 30 MHz: Conclusion: PASS

Note: The amplitude of spurious emissions which are attenuated by more than 20dB below the permissible value has no need to be reported.

30MHz-1GHz

Temperature:	23.5 °C	Relative Humidity:	46%
Test Voltage:	DC 120V/60HZ		
Ant. Pol.	Horizontal		
Test Mode:	TX Mode		
Remark:	No report for the emission which more than 10 dB below the prescribed limit.		

No.	Frequency (MHz)	Reading (dBuV)	Factor (dB/m)	Level (dBuV/m)	Limit (dBuV/m)	Margin (dB)	Detector
1 *	434.0651	82.71	-17.46	65.25	46.00	19.25	peak
2	869.1300	45.45	-8.92	36.53	46.00	-9.47	peak

Emission Level= Read Level+ Correct Factor
Average Value=Peak Value-8.56

Frequency (MHz)	Peak Level (dBμV/m)	AV Factor(dBμV/m)	Average Level (dBμV/m)	Limit(dBμV/m) (average)	Limit(dBμV/m) (Peak)	Conclusion
434.0651	65.25	-8.56	56.94	80.82	100.82	PASS
869.1300	36.53	-8.56	27.97	60.82	80.82	PASS

Temperature:	23.5 °C	Relative Humidity:	46%
Test Voltage:	DC 120V/60HZ		
Ant. Pol.	Vertical		
Test Mode:	TX Mode		
Remark:	No report for the emission which more than 10 dB below the prescribed limit.		

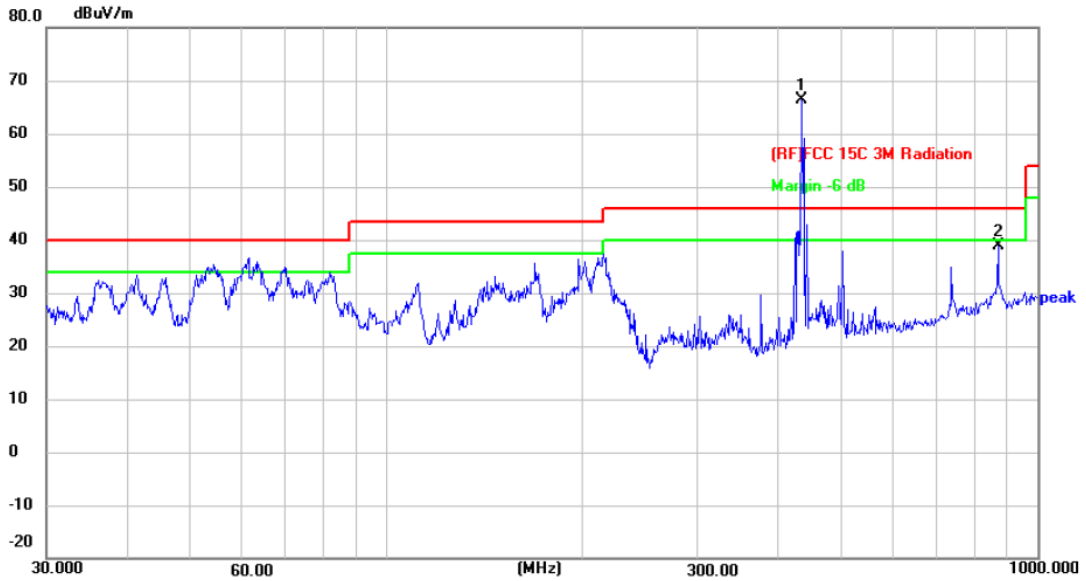

No.	Frequency (MHz)	Reading (dBuV)	Factor (dB/m)	Level (dBuV/m)	Limit (dBuV/m)	Margin (dB)	Detector
1 *	434.0650	83.94	-17.46	66.48	46.00	20.48	peak
2	869.1300	47.74	-8.92	38.82	46.00	-7.18	peak

Emission Level= Read Level+ Correct Factor

Average Value=Peak Value-8.56

Frequency (MHz)	Peak Level (dBuV/m)	AV Factor(dBμV/m)	Average Level (dBμV/m)	Limit(dBμV/m) (average)	Limit(dBμV/m) (Peak)	Conclusion
434.0650	66.48	-8.56	57.92	80.82	100.82	PASS
869.1300	38.32	-8.56	29.76	60.82	80.82	PASS

Above 1G

Temperature:	23.5 °C	Relative Humidity:	46%
Test Voltage:	DC 120V/60HZ		
Ant. Pol.	Horizontal		
Test Mode:	TX Mode		
Remark:	The peak value < average limit, So only show the peak value.		

No.	Frequency (MHz)	Reading (dBuV)	Factor (dB/m)	Level (dBuV/m)	Limit (dBuV/m)	Margin (dB)	Detector
1	3155.000	53.57	-3.72	49.85	74.00	-24.15	peak
2 *	4460.000	53.18	-1.34	51.84	74.00	-22.16	peak

Emission Level= Read Level+ Correct Factor

Average Value=Peak Value-8.56

Temperature:	23.5 °C	Relative Humidity:	46%
Test Voltage:	DC 120V/60HZ		
Ant. Pol.	Vertical		
Test Mode:	TX Mode		
Remark:	The peak value < average limit, So only show the peak value.		

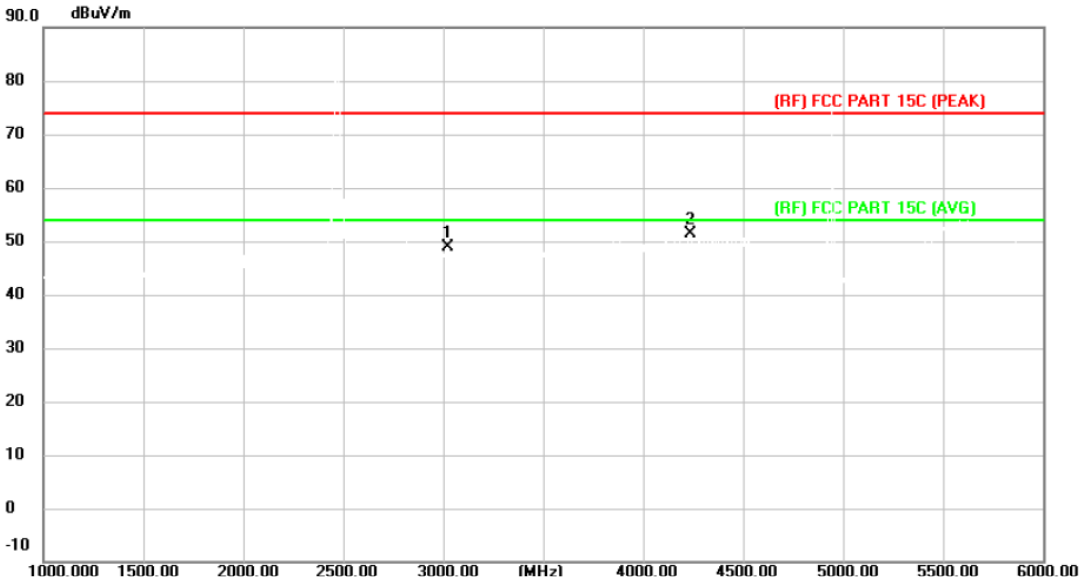

No.	Frequency (MHz)	Reading (dBuV)	Factor (dB/m)	Level (dBuV/m)	Limit (dBuV/m)	Margin (dB)	Detector
1	3025.000	52.57	-3.81	48.76	74.00	-25.24	peak
2 *	4235.000	53.25	-1.96	51.29	74.00	-22.71	peak

Emission Level= Read Level+ Correct Factor

Average Value=Peak Value-8.56

Other harmonics emissions are lower than 20dB below the allowable limit.

Note: (1) All Readings are Peak Value and AV. And AV is calculated by the following:

Testing frequency range below 1GHz the measuring instrument use VBW=120 kHz with Quasi-peak detection.

Testing frequency range above 1GHz the measuring instrument use RBW=1 MHz and VBW=3 MHz with Peak Detector for Peak Values.

Average Values=Peak Values+20log (Duty Cycle)

(2) Emission Level= Reading Level + Probe Factor +Cable Loss

(3) Data of measurement within this frequency range shown “ -- ” in the table above means the reading of emissions are attenuated more than 20dB below the permissible limits or the field strength is too small to be measured.

Pulse Desensitization Correction Factor

Note:

1)The Smallest Pulse Width (PW)= 0.4ms

(2) $2/PW=2/0.4(\text{ms})=5\text{kHz}<100\text{ kHz}$

Because $2/PW<RBW$, so the PDCF is not needed.

Attachment C--Bandwidth Data

Temperature	:	25 °C
Relative Humidity	:	55 %
Pressure	:	1010 hPa
Test Power	:	DC 5V

Frequency (MHz)	20 dBc Bandwidth (kHz)	99% OBW (kHz)	Limit (kHz)	Result
433.92	31.88	27.630	1084.8	PASS

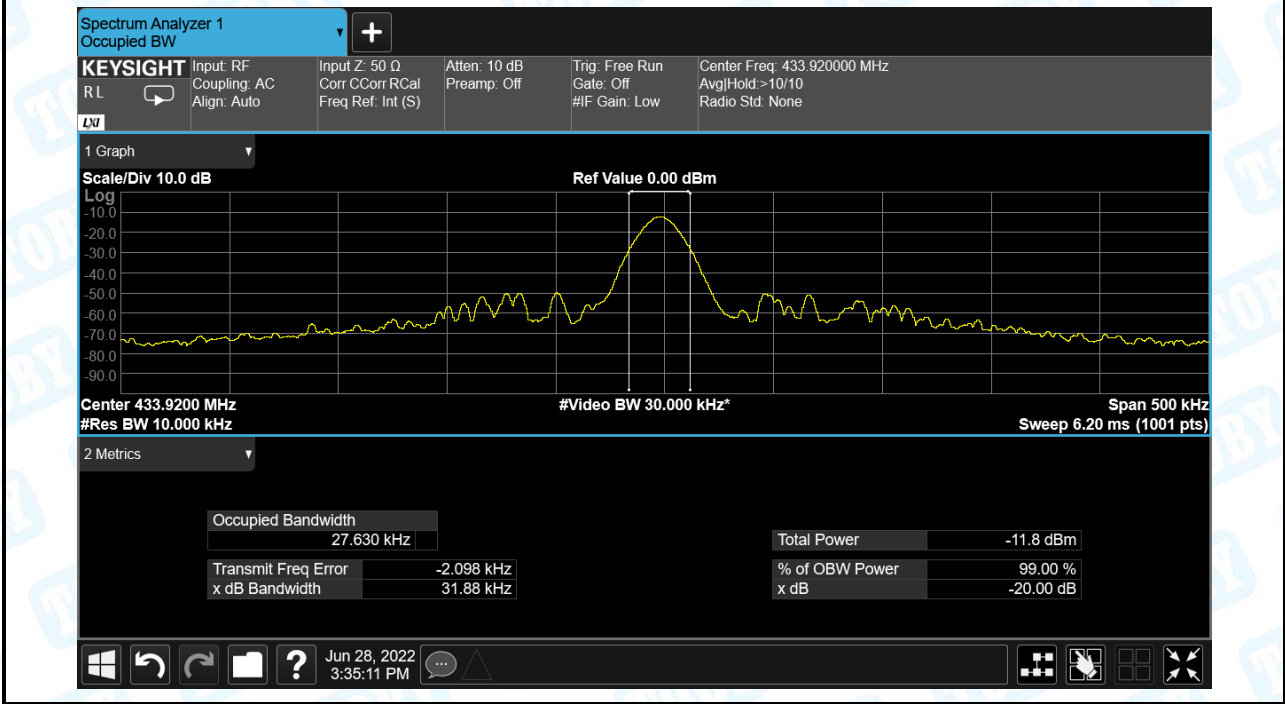

Attachment D-- Release Time Measurement Data

Temperature	:	25 °C
Relative Humidity	:	55 %
Pressure	:	1010 hPa
Test Power	:	DC 5V
Release Time(s)		
0.005	Limit (s)	5
		Result
		PASS

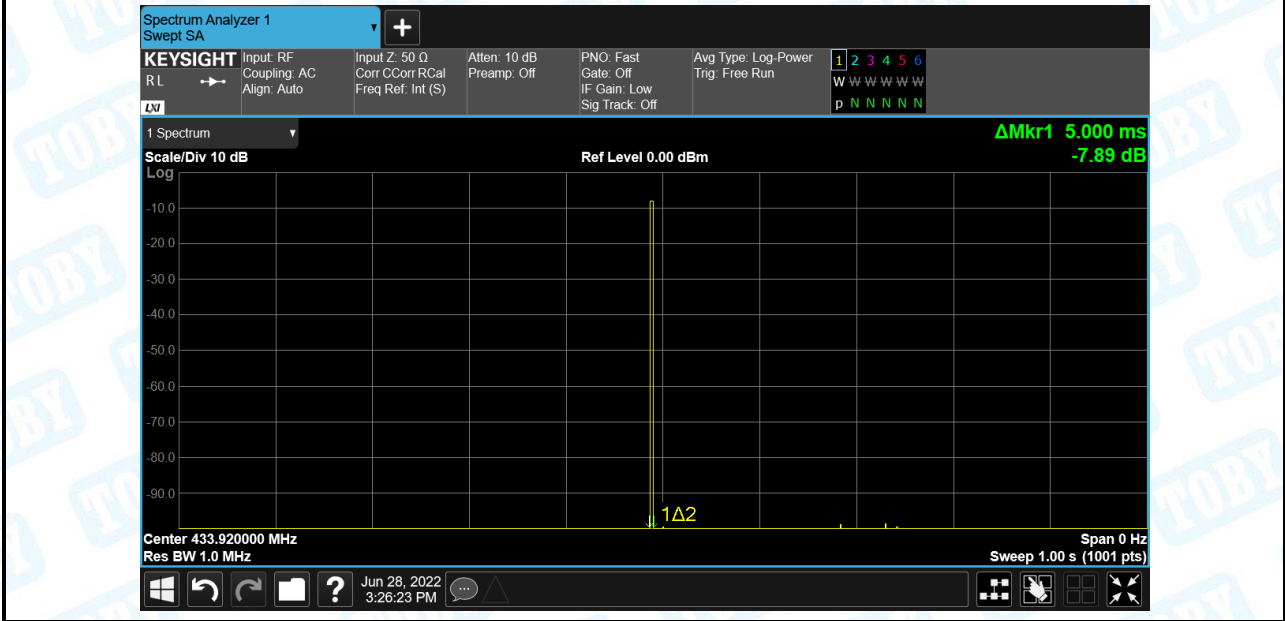

Attachment E--Duty Cycle Data

Please refer the following pages:

Plot 1/Plot 2: transmit once in 100ms, and each cycle is 38.90 ms there are two kinds of pulse in each cycle, the large pulses total 10, the little pulses total 15.

Plot 3: one large pulse in a time period of 0.920ms

Plot 5: one little pulse in a time period of 0.340ms

Duty Cycle=ON/Total=(0.35 *17+0.93*8)/35.88 =13.39/35.88=37.32%

20 log(Duty Cycle)=-8.56

Average=Peak Value+ 20log(Duty Cycle), AV=PK-8.56

Plot 1



Plot 2

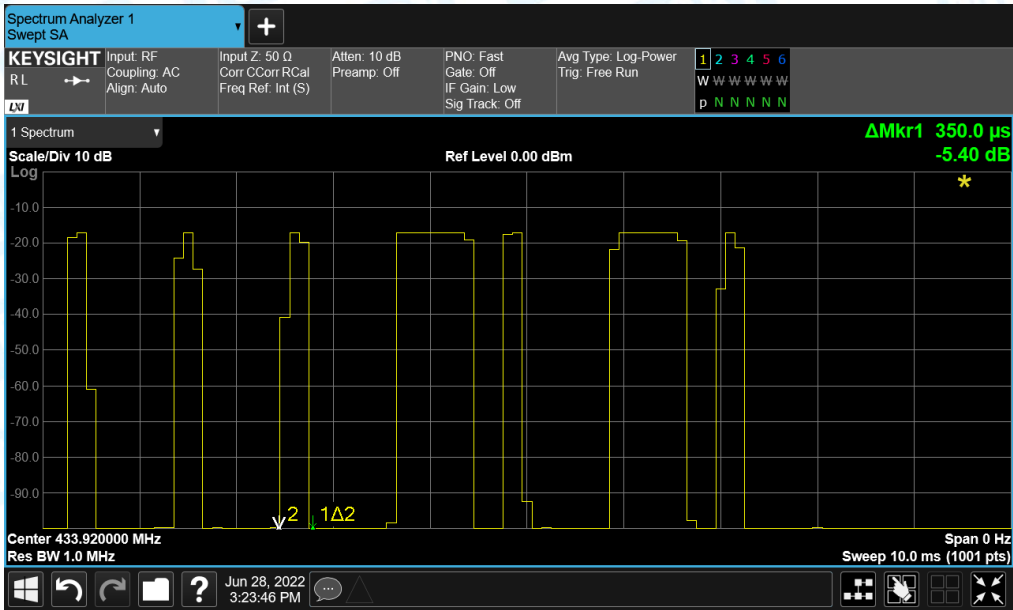

Plot 3

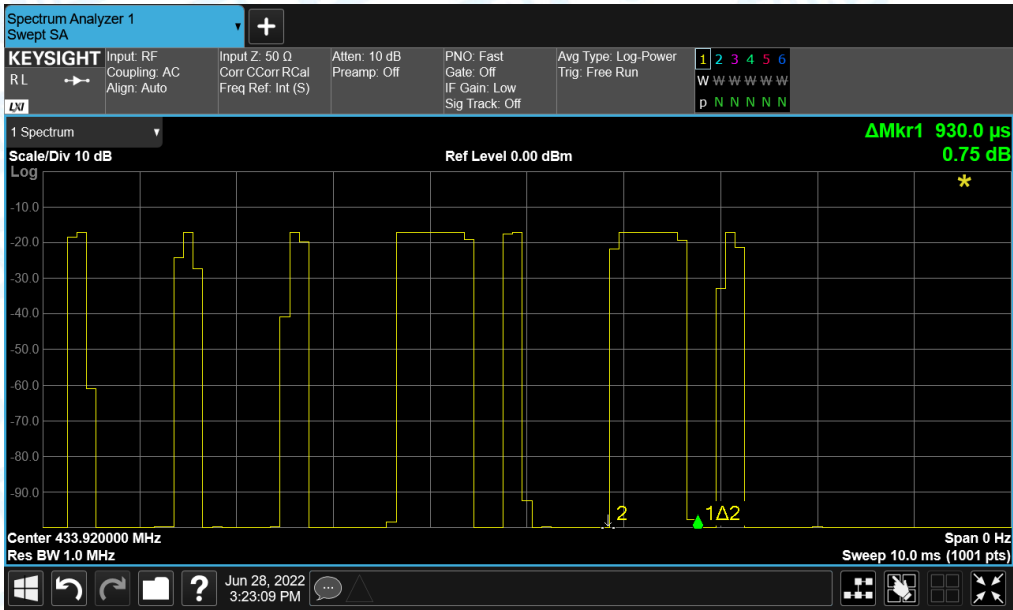

-----END OF REPORT-----