



Radio Test Report

FCC ID: 2A8TU-TS06PRO

Report No. : TBR-C-202205-0291-6
Applicant : Shenzhen Forever Young Technology Co., Ltd
Equipment Under Test (EUT)
EUT Name : Smart AC Controller with Touch Button
Model No. : TS06Pro
Series Model No. : TS08Pro, TS25
Brand Name : Zitech
Sample ID : RW-C-202205-0291-3-1#&RW-C-202205-0291-3-2#
Receipt Date : 2022-06-10
Test Date : 2022-06-10 to 2022-06-28
Issue Date : 2023-01-31
Standards : FCC Part 15 Subpart C 15.247
Test Method : ANSI C63.10: 2013
KDB 558074 D01 15.247 Meas Guidance v05r02
Conclusions : **PASS**

In the configuration tested, the EUT complied with the standards specified above.

Witness Engineer : *Wade Lv*
Engineer Supervisor : *IVAN SU*
Engineer Manager : *Ray Lai*



This report details the results of the testing carried out on one sample. The results contained in this test report do not relate to other samples of the same product. The manufacturer should ensure that all products in series production are in conformity with the product sample detailed in the report.

Contents

CONTENTS	2
1. GENERAL INFORMATION ABOUT EUT	5
1.1 Client Information.....	5
1.2 General Description of EUT (Equipment Under Test)	5
1.3 Block Diagram Showing the Configuration of System Tested.....	6
1.4 Description of Support Units	7
1.5 Description of Test Mode.....	7
1.6 Description of Test Software Setting	8
1.7 Measurement Uncertainty	8
1.8 Test Facility.....	9
2. TEST SUMMARY	10
3. TEST SOFTWARE	10
4. TEST EQUIPMENT	11
5. CONDUCTED EMISSION	12
5.1 Test Standard and Limit.....	12
5.2 Test Setup.....	12
5.3 Test Procedure.....	12
5.4 Deviation From Test Standard.....	13
5.5 EUT Operating Mode	13
5.6 Test Data.....	13
6. RADIATED AND CONDUCTED UNWANTED EMISSIONS	14
6.1 Test Standard and Limit.....	14
6.2 Test Setup.....	15
6.3 Test Procedure.....	16
6.4 Deviation From Test Standard.....	17
6.5 EUT Operating Mode	17
6.6 Test Data.....	17
7. RESTRICTED BANDS REQUIREMENT	18
7.1 Test Standard and Limit.....	18
7.2 Test Setup.....	18
7.3 Test Procedure.....	19
7.4 Deviation From Test Standard.....	20
7.5 EUT Operating Mode	20
7.6 Test Data.....	20
8. BANDWIDTH TEST	21
8.1 Test Standard and Limit.....	21
8.2 Test Setup.....	21
8.3 Test Procedure.....	21
8.4 Deviation From Test Standard.....	22



8.5 EUT Operating Mode	22
8.6 Test Data	22
9. PEAK OUTPUT POWER	23
9.1 Test Standard and Limit	23
9.2 Test Setup	23
9.3 Test Procedure	23
9.4 Deviation From Test Standard	23
9.5 EUT Operating Mode	23
9.6 Test Data	23
10. POWER SPECTRAL DENSITY	24
10.1 Test Standard and Limit	24
10.2 Test Setup	24
10.3 Test Procedure	24
10.4 Deviation From Test Standard	24
10.5 Antenna Connected Construction	24
10.6 Test Data	24
11. ANTENNA REQUIREMENT	25
11.1 Test Standard and Limit	25
11.2 Deviation From Test Standard	25
11.3 Antenna Connected Construction	25
11.4 Test Data	25
ATTACHMENT A-- CONDUCTED EMISSION TEST DATA	26
ATTACHMENT B--UNWANTED EMISSIONS DATA	28



Revision History

Report No.	Version	Description	Issued Date
TBR-C-202205-0291-6	Rev.01	Initial issue of report	2023-01-31



1. General Information about EUT

1.1 Client Information

Applicant	:	Shenzhen Forever Young Technology Co., Ltd
Address	:	2/F, No.B2 Bldg, Fu Yuan Industrial Park, Fu Yong Town, Bao'an District, Shenzhen, China
Manufacturer	:	Shenzhen Forever Young Technology Co., Ltd
Address	:	2/F, No.B2 Bldg, Fu Yuan Industrial Park, Fu Yong Town, Bao'an District, Shenzhen, China

1.2 General Description of EUT (Equipment Under Test)

EUT Name	:	Smart AC Controller with Touch Button	
Models No.	:	TS06Pro, TS08Pro, TS25	
Model Different	:	All these models are identical in the same PCB, layout and electrical circuit, the only difference is appearance.	
Product Description	:	Operation Frequency:	Bluetooth 4.2(BLE): 2402MHz~2480MHz
		Number of Channel:	Bluetooth 4.2(BLE): 40 channels
		Antenna Gain:	2.21dBi PCB Antenna
		Modulation Type:	GFSK
		Bit Rate of Transmitter:	1Mbps
Power Rating	:	Micro Input: DC 5V/1A	
Software Version	:	V3.35.5	
Hardware Version	:	V1.1.80	
Remark:			
(1)The antenna gain and adapter provided by the applicant, the verified for the RF conduction test provided by TOBY test lab.			
(2)For a more detailed features description, please refer to the manufacturer's specifications or the User's Manual.			
(3)Antenna information provided by the applicant.			



(4)Channel List:

Channel	Frequency (MHz)	Channel	Frequency (MHz)	Channel	Frequency (MHz)
00	2402	14	2430	28	2458
01	2404	15	2432	29	2460
02	2406	16	2434	30	2462
03	2408	17	2436	31	2464
04	2410	18	2438	32	2466
05	2412	19	2440	33	2468
06	2414	20	2442	34	2470
07	2416	21	2444	35	2472
08	2418	22	2446	36	2474
09	2420	23	2448	37	2476
10	2422	24	2450	38	2478
11	2424	25	2452	39	2480
12	2426	26	2454		
13	2428	27	2456		

1.3 Block Diagram Showing the Configuration of System Tested

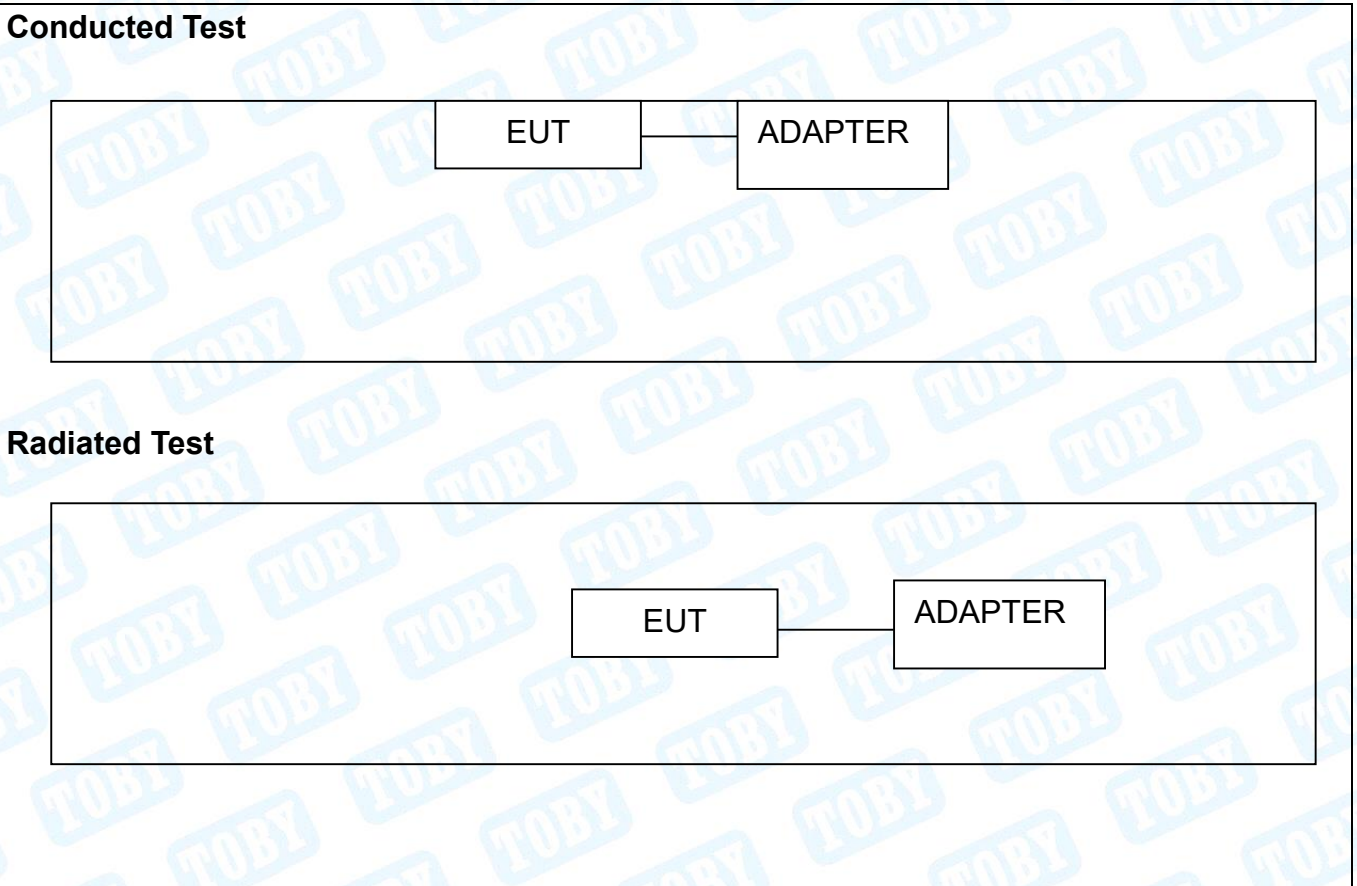

1.4 Description of Support Units

Equipment Information				
Name	Model	FCC ID/SDOC	Manufacturer	Used “√”
---	----	----	---	---
Cable Information				
Number	Shielded Type	Ferrite Core	Length	Note
Cable 1	Yes	NO	1.0M	Accessory

1.5 Description of Test Mode

To investigate the maximum EMI emission characteristics generates from EUT, the test system was pre-scanning tested base on the consideration of following EUT operation mode or test configuration mode which possible have effect on EMI emission level. Each of these EUT operation mode(s) or test configuration mode(s) mentioned follow was evaluated respectively.

For Conducted Test	
Final Test Mode	Description
Mode 1	TX Mode
For Radiated Test	
Final Test Mode	Description
Mode 2	TX 1Mbps Mode (Channel 00/19/39)

Note:

- (1) For all test, we have verified the construction and function in typical operation. And all the test modes were carried out with the EUT in transmitting operation in maximum power with all kinds of data rate.
According to ANSI C63.10 standards, the measurements are performed at the highest, middle, lowest available channels, and the worst case data rate as follows:
BLE Mode: GFSK Modulation Transmitting mode.
- (2) During the testing procedure, the continuously transmitting with the maximum power mode was programmed by the customer.
- (3) The EUT is considered a Mobile unit; in normal use it was positioned on X-plane. The worst case was found positioned on X-plane. Therefore only the test data of this X-plane was used for radiated emission measurement test.



1.6 Description of Test Software Setting

During testing channel & Power controlling software provided by the customer was used to control the operating channel as well as the output power level. The RF output power selection is for the setting of RF output power expected by the customer and is going to be fixed on the firmware of the final end product power parameters of RF setting.

Test Software Version	RTLBTAPP		
Frequency	2402 MHz	2440MHz	2480 MHz
BLE 1M	DEF	DEF	DEF

1.7 Measurement Uncertainty

The reported uncertainty of measurement $y \pm U$, where expanded uncertainty U is based on a standard uncertainty multiplied by a coverage factor of $k=2$, providing a level of confidence of approximately 95 %.

Test Item	Parameters	Expanded Uncertainty (U_{Lab})
Conducted Emission	Level Accuracy: 9kHz~150kHz 150kHz to 30MHz	± 3.50 dB ± 3.10 dB
Radiated Emission	Level Accuracy: 9kHz to 30 MHz	± 4.60 dB
Radiated Emission	Level Accuracy: 30MHz to 1000 MHz	± 4.50 dB
Radiated Emission	Level Accuracy: Above 1000MHz	± 4.20 dB



1.8 Test Facility

The testing report were performed by the Shenzhen Toby Technology Co., Ltd., in their facilities located at 1/F., Building 6, Rundongsheng Industrial Zone, Longzhu, Xixiang, Bao'an District, Shenzhen, Guangdong, China. At the time of testing, the following bodies accredited the Laboratory:

CNAS (L5813)

The Laboratory has been accredited by CNAS to ISO/IEC 17025: 2017 General Requirements for the Competence of Testing and Calibration Laboratories for the competence in the field of testing. And the Registration No.: CNAS L5813.

A2LA Certificate No.: 4750.01

The laboratory has been accredited by American Association for Laboratory Accreditation(A2LA) to ISO/IEC 17025: 2017 General Requirements for the Competence of Testing and Calibration Laboratories for the technical competence in the field of Electrical Testing. And the A2LA Certificate No.: 4750.01.FCC Accredited Test Site Number: 854351. Designation Number: CN1223.

IC Registration No.: (11950A)

The Laboratory has been registered by Certification and Engineering Bureau of Industry Canada for radio equipment testing. The site registration: Site# 11950A. CAB identifier: CN0056.



2. Test Summary

Standard Section	Test Item	Test Sample(s)	Judgment	Remark
FCC				
FCC 15.207(a)	Conducted Emission	RW-C-202205-0291-3-1#	PASS	N/A
FCC 15.209 & 15.247(d)	Radiated Unwanted Emissions	RW-C-202205-0291-3-1#	PASS	N/A
FCC 15.203	Antenna Requirement	RW-C-202205-0291-3-2#	PASS	N/A
FCC 15.247(a)(2)	6dB Bandwidth	RW-C-202205-0291-3-2#	PASS	N/A
/	99% Occupied bandwidth	RW-C-202205-0291-3-2#	PASS	N/A
FCC 15.247(b)(3)	Peak Output Power and E.I.R.P	RW-C-202205-0291-3-2#	PASS	N/A
FCC 15.247(e)	Power Spectral Density	RW-C-202205-0291-3-2#	PASS	N/A
FCC 15.247(d)	Band Edge Measurements	RW-C-202205-0291-3-2#	PASS	N/A
FCC 15.207	Conducted Unwanted Emissions	RW-C-202205-0291-3-2#	PASS	N/A
FCC 15.247(d)	Emissions in Restricted Bands	RW-C-202205-0291-3-2#	PASS	N/A
/	On Time and Duty Cycle	RW-C-202205-0291-3-2#	/	N/A

Note: N/A is an abbreviation for Not Applicable.

3. Test Software

Test Item	Test Software	Manufacturer	Version No.
Conducted Emission	EZ-EMC	EZ	CDI-03A2
Radiation Emission	EZ-EMC	EZ	FA-03A2RE
Radiation Emission	EZ-EMC	EZ	FA-03A2RE+
RF Conducted Measurement	MTS-8310	MWRFtest	V2.0.0.0
RF Test System	JS1120	Tonscend	V2.6.88.0336



4. Test Equipment

Conducted Emission Test					
Equipment	Manufacturer	Model No.	Serial No.	Last Cal.	Cal. Due Date
EMI Test Receiver	Rohde & Schwarz	ESCI	100321	Jul. 02, 2021	Jul. 01, 2022
RF Switching Unit	Compliance Direction Systems Inc	RSU-A4	34403	Jul. 02, 2021	Jul. 01, 2022
AMN	SCHWARZBECK	NNBL 8226-2	8226-2/164	Jul. 02, 2021	Jul. 01, 2022
LISN	Rohde & Schwarz	ENV216	101131	Jul. 02, 2021	Jul. 01, 2022
Radiation Emission Test (A Site)					
Equipment	Manufacturer	Model No.	Serial No.	Last Cal.	Cal. Due Date
Spectrum Analyzer	Rohde & Schwarz	FSV40-N	102197	Jul. 02, 2021	Jul. 01, 2022
EMI Test Receiver	Rohde & Schwarz	ESPI	100010/007	Jul. 02, 2021	Jul. 01, 2022
Bilog Antenna	ETS-LINDGREN	3142E	00117537	Feb. 27, 2022	Feb. 26, 2024
Horn Antenna	ETS-LINDGREN	3117	00143207	Feb. 26, 2022	Feb. 25, 2024
Horn Antenna	SCHWARZBECK	BBHA 9170	1118	Feb. 26, 2022	Feb. 25, 2024
Loop Antenna	SCHWARZBECK	FMZB 1519 B	1519B-059	Jul. 06, 2021	Jul. 05, 2022
Pre-amplifier	SONOMA	310N	185903	Feb. 26, 2022	Feb. 25, 2023
Pre-amplifier	HP	8449B	3008A00849	Feb. 26, 2022	Feb. 25, 2023
HF Amplifier	Tonscend	TAP0184050	AP21C806129	Sep. 03, 2021	Sep. 02, 2022
Radiation Emission Test (B Site)					
Equipment	Manufacturer	Model No.	Serial No.	Last Cal.	Cal. Due Date
Spectrum Analyzer	Rohde & Schwarz	FSV40-N	102197	Jul. 02, 2021	Jul. 01, 2022
MXA Signal Analyzer	Agilent	N9020A	MY47380425	Sep. 03, 2021	Sep. 02, 2022
EMI Test Receiver	Rohde & Schwarz	ESU-8	100472	Feb. 26, 2022	Feb. 25, 2023
Bilog Antenna	SCHWARZBECK	VULB 9168	1225	Dec. 05, 2021	Dec. 04, 2023
Horn Antenna	SCHWARZBECK	BBHA 9120 D	2463	May 20, 2021	May 19, 2023
Horn Antenna	SCHWARZBECK	BBHA 9170	1118	Feb. 26, 2022	Feb. 25, 2024
Loop Antenna	SCHWARZBECK	FMZB 1519 B	1519B-059	Jul. 06, 2021	Jul. 05, 2022
HF Amplifier	Tonscend	TAP9E6343	AP21C806117	Sep. 03, 2021	Sep. 02, 2022
HF Amplifier	Tonscend	TAP051845	AP21C806141	Sep. 03, 2021	Sep. 02, 2022
HF Amplifier	Tonscend	TAP0184050	AP21C806129	Sep. 03, 2021	Sep. 02, 2022
Antenna Conducted Emission					
Equipment	Manufacturer	Model No.	Serial No.	Last Cal.	Cal. Due Date
Spectrum Analyzer	Agilent	E4407B	MY45106456	Jul. 02, 2021	Jul. 01, 2022
Spectrum Analyzer	Rohde & Schwarz	FSV40-N	102197	Jul. 02, 2021	Jul. 01, 2022
MXA Signal Analyzer	Agilent	N9020A	MY49100060	Sep. 03, 2021	Sep. 02, 2022
Spectrum Analyzer	KEYSIGT	N9020B	MY60110172	Sep. 03, 2021	Sep. 02, 2022
RF Power Sensor	DARE!! Instruments	RadiPowerRPR3006W	17I00015SNO26	Sep. 03, 2021	Sep. 02, 2022
	DARE!! Instruments	RadiPowerRPR3006W	17I00015SNO29	Sep. 03, 2021	Sep. 02, 2022
	DARE!! Instruments	RadiPowerRPR3006W	17I00015SNO31	Sep. 03, 2021	Sep. 02, 2022
	DARE!! Instruments	RadiPowerRPR3006W	17I00015SNO33	Sep. 03, 2021	Sep. 02, 2022
RF Control Unit	Tonsced	JS0806-2	21F8060439	Sep. 03, 2021	Sep. 02, 2022



5. Conducted Emission

5.1 Test Standard and Limit

5.1.1 Test Standard

FCC Part 15.207

5.1.2 Test Limit

Frequency	Maximum RF Line Voltage (dB μ V)	
	Quasi-peak Level	Average Level
150kHz~500kHz	66 ~ 56 *	56 ~ 46 *
500kHz~5MHz	56	46
5MHz~30MHz	60	50

Notes:

- (1) *Decreasing linearly with logarithm of the frequency.
- (2) The lower limit shall apply at the transition frequencies.
- (3) The limit decrease in line with the logarithm of the frequency in the range of 0.15 to 0.50MHz.

5.2 Test Setup

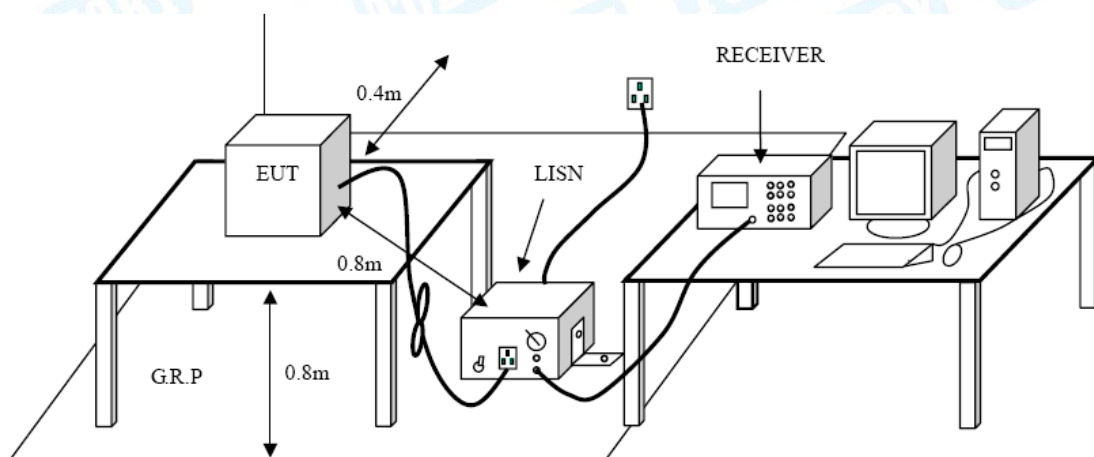

5.3 Test Procedure

- The EUT was placed 0.8 meters from the horizontal ground plane with EUT being connected to the power mains through a line impedance stabilization network (LISN). All other support equipments powered from additional LISN(s). The LISN provide 50 Ohm/50uH of coupling impedance for the measuring instrument.
- Interconnecting cables that hang closer than 40 cm to the ground plane shall be folded back and forth in the center forming a bundle 30 to 40 cm long.
- I/O cables that are not connected to a peripheral shall be bundled in the center. The end of the cable may be terminated, if required, using the correct terminating impedance. The overall length shall not exceed 1 m.
- LISN at least 80 cm from nearest part of EUT chassis.
- The bandwidth of EMI test receiver is set at 9 kHz, and the test frequency band is from 0.15MHz to 30MHz.



5.4 Deviation From Test Standard

No deviation

5.5 EUT Operating Mode

Please refer to the description of test mode.

5.6 Test Data

Please refer to the Attachment A inside test report.



6. Radiated and Conducted Unwanted Emissions

6.1 Test Standard and Limit

6.1.1 Test Standard

FCC Part 15.209 & FCC Part 15.247(d)

6.1.2 Test Limit

General field strength limits at frequencies Below 30MHz		
Frequency (MHz)	Field Strength (microvolt/meter)**	Measurement Distance (meters)
0.009~0.490	2400/F(KHz)	300
0.490~1.705	24000/F(KHz)	30
1.705~30.0	30	30

Note: 1, The emission limits for the ranges 9-90 kHz and 110-490 kHz are based on measurements employing a linear average detector.

General field strength limits at frequencies above 30 MHz		
Frequency (MHz)	Field strength (µV/m at 3 m)	Measurement Distance (meters)
30~88	100	3
88~216	150	3
216~960	200	3
Above 960	500	3

General field strength limits at frequencies Above 1000MHz		
Frequency (MHz)	Distance of 3m (dBuV/m)	
	Peak	Average
Above 1000	74	54

Note:
 (1) The tighter limit applies at the band edges.
 (2) Emission Level(dBuV/m)=20log Emission Level(uV/m)

In any 100 kHz bandwidth outside the frequency band in which the spread spectrum or digitally modulated device is operating, the RF power that is produced shall be at least 20 dB below that in the 100 kHz bandwidth within the band that contains the highest level of the desired power, based on either an RF conducted or a radiated measurement, provided that the transmitter demonstrates compliance with the peak conducted power limits. If the transmitter complies with the conducted power limits based on the use of root-mean-square averaging over a time interval, as permitted under section 5.4(d), the attenuation required shall be 30 dB instead of 20 dB. Attenuation below the general field strength limits specified in RSS-Gen is not required.



6.2 Test Setup

Radiated measurement

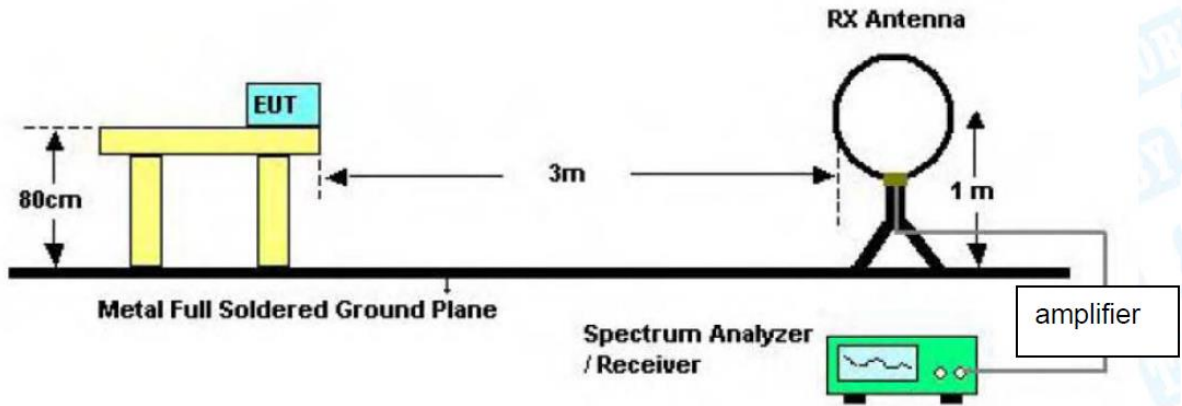

Below 30MHz Test Setup

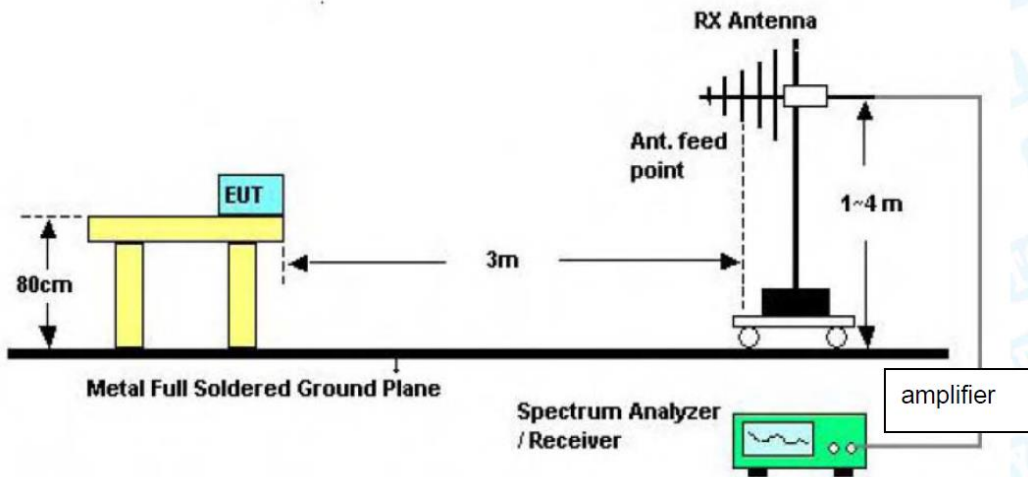

Below 1000MHz Test Setup

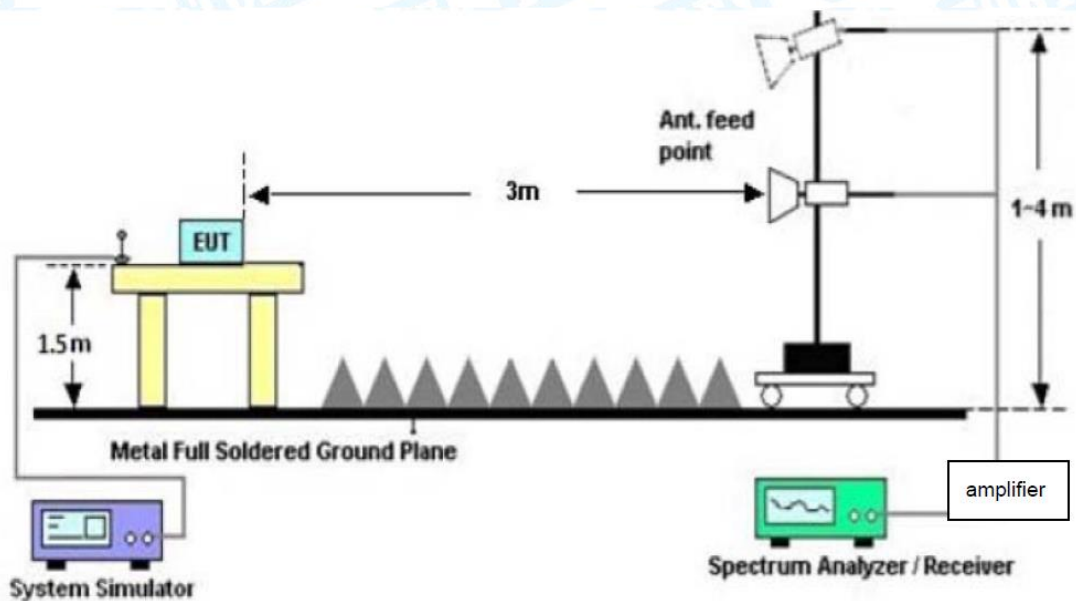

Above 1GHz Test Setup Conducted measurement

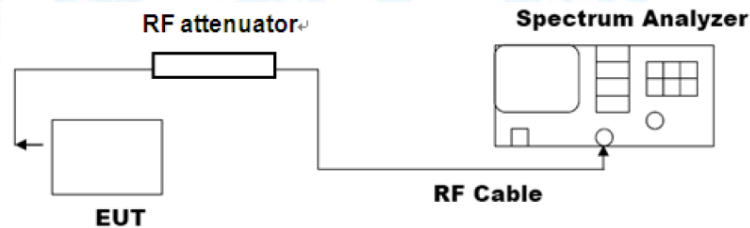

6.3 Test Procedure

---Radiated measurement

- The measuring distance of 3m shall be used for measurements at frequency up to 1GHz and above 1 GHz. The EUT was placed on a rotating 0.8m high above ground, the table was rotated 360 degrees to determine the position of the highest radiation.
- Measurements at frequency above 1GHz. The EUT was placed on a rotating 1.5m high above the ground. RF absorbers covered the ground plane with a minimum area of 3.0m by 3.0m between the EUT and measurement receiver antenna. The RF absorber shall not exceed 30cm in high above the conducting floor. The table was rotated 360 degrees to determine the position of the highest radiation.
- The Test antenna shall vary between 1m and 4m, Both Horizontal and Vertical antenna are set to make measurement.
- The initial step in collecting conducted emission data is a spectrum analyzer peak detector mode pre-scanning the measurement frequency range. Significant peaks are then marked and then Quasi Peak detector mode re-measured.
- If the Peak Mode measured value compliance with and lower than Quasi Peak Mode Limit Below 1 GHz, the EUT shall be deemed to meet QP Limits and then no additional QP Mode measurement performed. But the Peak Value and average value both need to comply with applicable limit above 1 GHz.
- Testing frequency range 30MHz-1GHz the measuring instrument use VBW=120 kHz with Quasi-peak detection. Testing frequency range 9KHz-150Hz the measuring instrument use VBW=200Hz with Quasi-peak detection. Testing frequency range 9KHz-30MHz the measuring instrument use VBW=9kHz with Quasi-peak detection.
- Testing frequency range above 1GHz the measuring instrument use RBW=1 MHz and VBW=3 MHz with Peak Detector for Peak Values, and use RBW=1 MHz and VBW=10 Hz with Peak Detector for Average Values.
- For the actual test configuration, please see the test setup photo.



--- Conducted measurement**● Reference level measurement**

Establish a reference level by using the following procedure:

- a) Set instrument center frequency to DTS channel center frequency.
- b) Set the span to ≥ 1.5 times the DTS bandwidth.
- c) Set the RBW = 100 kHz.
- d) Set the VBW $\geq [3 \cdot \text{RBW}]$.
- e) Detector = peak.
- f) Sweep time = auto couple.
- g) Trace mode = max hold.
- h) Allow trace to fully stabilize.
- i) Use the peak marker function to determine the maximum PSD level.

Note that the channel found to contain the maximum PSD level can be used to establish the reference level.

● Emission level measurement

Establish an emission level by using the following procedure:

- a) Set the center frequency and span to encompass frequency range to be measured.
- b) Set the RBW = 100 kHz.
- c) Set the VBW $\geq [3 \cdot \text{RBW}]$.
- d) Detector = peak.
- e) Sweep time = auto couple.
- f) Trace mode = max hold.
- g) Allow trace to fully stabilize.
- h) Use the peak marker function to determine the maximum amplitude level.

Ensure that the amplitude of all unwanted emissions outside of the authorized frequency band (excluding restricted frequency bands) is attenuated by at least the minimum requirements specified in 11.11. Report the three highest emissions relative to the limit.

6.4 Deviation From Test Standard

No deviation

6.5 EUT Operating Mode

Please refer to the description of test mode.

6.6 Test Data

Radiated measurement please refer to the Attachment B inside test report.

Conducted measurement please refer to the external appendix report of BLE.



7. Restricted Bands Requirement

7.1 Test Standard and Limit

7.1.1 Test Standard

FCC Part 15.205 & FCC Part 15.247(d)

7.1.2 Test Limit

Restricted Frequency Band (MHz)	Distance Meters(at 3m)	
	Peak (dBuV/m)	Average (dBuV/m)
2310 ~2390	74	54
2483.5 ~2500	74	54
	Peak (dBm) _{see 7.3 e)}	Average (dBm) _{see 7.3 e)}
2310 ~2390	-21.20	-41.20
2483.5 ~2500	-21.20	-41.20

Note: According the ANSI C63.10 11.12.2 antenna-port conducted measurements may also be used as an alternative to radiated measurements for determining compliance in the restricted frequency bands requirements. If conducted measurements are performed, then proper impedance matching must be ensured and an additional radiated test forcabinet/case emissions is required.

7.2 Test Setup

Radiated measurement

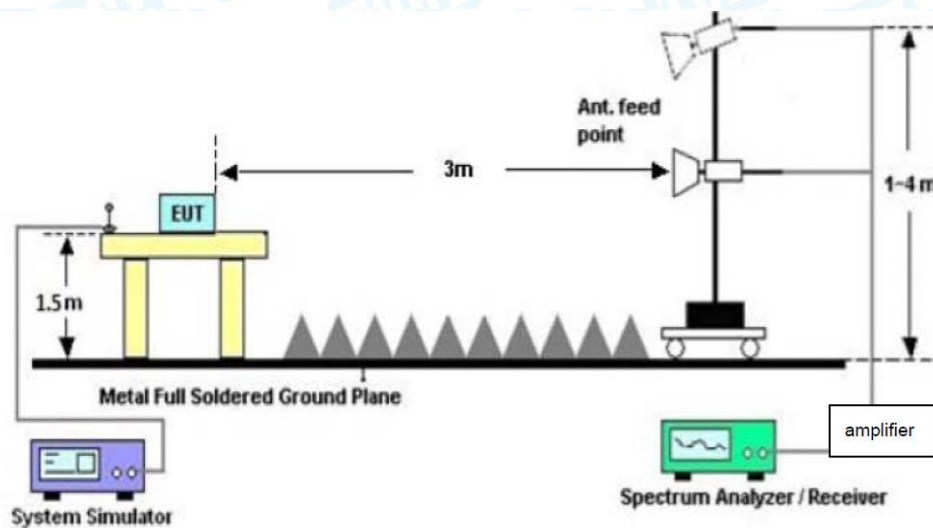

Conducted measurement

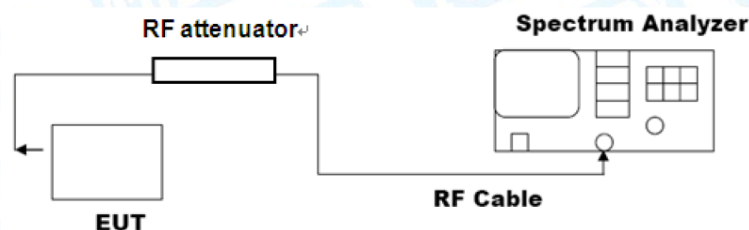

7.3 Test Procedure

---Radiated measurement

- Measurements at frequency above 1GHz. The EUT was placed on a rotating 1.5m high above the ground. RF absorbers covered the ground plane with a minimum area of 3.0m by 3.0m between the EUT and measurement receiver antenna. The RF absorber shall not exceed 30cm in high above the conducting floor. The table was rotated 360 degrees to determine the position of the highest radiation.
- The Test antenna shall vary between 1m and 4m, Both Horizontal and Vertical antenna are set to make measurement.
- The initial step in collecting conducted emission data is a spectrum analyzer peak detector mode pre-scanning the measurement frequency range. Significant peaks are then marked and then Quasi Peak detector mode re-measured.
- The Peak Value and average value both need to comply with applicable limit above 1 GHz.
- Testing frequency range above 1GHz the measuring instrument use RBW=1 MHz and VBW=3 MHz with Peak Detector for Peak Values, and use RBW=1 MHz and VBW=10 Hz with Peak Detector for Average Values.
- For the actual test configuration, please see the test setup photo.

--- Conducted measurement

- a) Measure the conducted output power (in dBm) using the detector specified by the appropriate regulatory agency (see 11.12.2.3 through 11.12.2.5 for guidance regarding measurement procedures for determining quasi-peak, peak, and average conducted output power, respectively).
- b) Add the maximum transmit antenna gain (in dBi) to the measured output power level to determine the EIRP (see 11.12.2.6 for guidance on determining the applicable antenna gain).
- c) Add the appropriate maximum ground reflection factor to the EIRP (6 dB for frequencies ≤ 30 MHz; 4.7 dB for frequencies between 30 MHz and 1000 MHz, inclusive; and 0 dB for frequencies > 1000 MHz).
- d) For MIMO devices, measure the power of each chain and sum the EIRP of all chains in linear terms (i.e., watts and mW).
- e) Convert the resultant EIRP to an equivalent electric field strength using the following relationship:
$$E = \text{EIRP} - 20 \log d + 104.8$$
where
 E is the electric field strength in dBuV/m
EIRP is the equivalent isotropically radiated power in dBm
 d is the specified measurement distance in m
- f) Compare the resultant electric field strength level with the applicable regulatory limit.
- g) Perform the radiated spurious emission test.



7.4 Deviation From Test Standard

No deviation

7.5 EUT Operating Mode

Please refer to the description of test mode.

7.6 Test Data

Remark: The test uses antenna-port conducted measurements as an alternative to radiated measurements for determining compliance in the restricted frequency bands requirements.

Please refer to the external appendix report of BLE.



8. Bandwidth Test

8.1 Test Standard and Limit

8.1.1 Test Standard

FCC Part 15.205 & FCC Part 15.247(d)

8.1.2 Test Limit

Test Item	Limit	Frequency Range(MHz)
-6dB bandwidth (DTS bandwidth)	≥ 500 KHz	2400~2483.5
99% occupied bandwidth	/	2400~2483.5

8.2 Test Setup

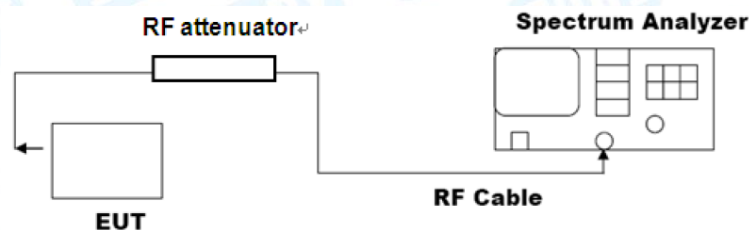

8.3 Test Procedure

---DTS bandwidth

● The steps for the first option are as follows:

- Set RBW = 100 kHz.
- Set the VBW $\geq [3 \times \text{RBW}]$.
- Detector = peak.
- Trace mode = max hold.
- Sweep = auto couple.
- Allow the trace to stabilize.
- Measure the maximum width of the emission that is constrained by the frequencies associated with the two outermost amplitude points (upper and lower frequencies) that are attenuated by 6 dB relative to the maximum level measured in the fundamental emission.

---occupied bandwidth

● The occupied bandwidth is the frequency bandwidth such that, below its lower and above its upper frequency limits, the mean powers are each equal to 0.5% of the total mean power of the given emission. The following procedure shall be used for measuring 99% power bandwidth:

- The instrument center frequency is set to the nominal EUT channel center frequency. The frequency span for the spectrum analyzer shall be between 1.5 times and 5.0 times the OBW.
- The nominal IF filter bandwidth (3 dB RBW) shall be in the range of 1% to 5% of the OBW, and VBW shall be approximately three times the RBW, unless otherwise specified



by the applicable requirement.

c) Set the reference level of the instrument as required, keeping the signal from exceeding the maximum input mixer level for linear operation. In general, the peak of the spectral envelope shall be more than $[10 \log (\text{OBW}/\text{RBW})]$ below the reference level. Specific guidance is given in 4.1.5.2.

d) Step a) through step c) might require iteration to adjust within the specified range.

e) Video averaging is not permitted. Where practical, a sample detection and single sweep mode shall be used. Otherwise, peak detection and max hold mode (until the trace stabilizes) shall be used.

f) Use the 99% power bandwidth function of the instrument (if available) and report the measured bandwidth.

g) If the instrument does not have a 99% power bandwidth function, then the trace data points are recovered and directly summed in linear power terms. The recovered amplitude data points, beginning at the lowest frequency, are placed in a running sum until 0.5% of the total is reached; that frequency is recorded as the lower frequency. The process is repeated until 99.5% of the total is reached; that frequency is recorded as the upper frequency. The 99% power bandwidth is the difference between these two frequencies.

h) The occupied bandwidth shall be reported by providing plot(s) of the measuring instrument display; the plot axes and the scale units per division shall be clearly labeled. Tabular data may be reported in addition to the plot(s).

8.4 Deviation From Test Standard

No deviation

8.5 EUT Operating Mode

Please refer to the description of test mode.

8.6 Test Data

Please refer to the external appendix report of BLE.



9. Peak Output Power

9.1 Test Standard and Limit

9.1.1 Test Standard

FCC Part 15.247(b)(3)

9.1.2 Test Limit

Test Item	Limit	Frequency Range(MHz)
Peak Output Power	not exceed 1 W or 30dBm	2400~2483.5

9.2 Test Setup

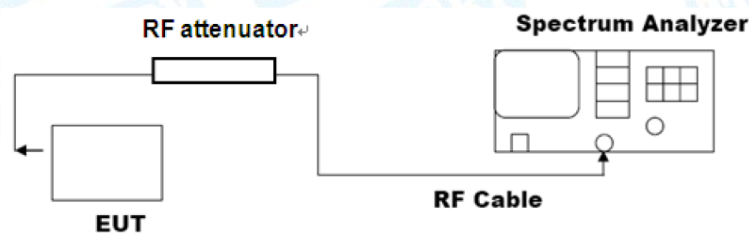

9.3 Test Procedure

---RBW \geq DTS bandwidth

● The following procedure shall be used when an instrument with a resolution bandwidth that is greater than the DTS bandwidth is available to perform the measurement:

- Set the RBW \geq DTS bandwidth.
- Set VBW \geq [3*RBW].
- Set span \geq [3*RBW].
- Sweep time = auto couple.
- Detector = peak.
- Trace mode = max hold.
- Allow trace to fully stabilize.
- Use peak marker function to determine the peak amplitude level.

9.4 Deviation From Test Standard

No deviation

9.5 EUT Operating Mode

Please refer to the description of test mode.

9.6 Test Data

Please refer to the external appendix report of BLE.



10. Power Spectral Density

10.1 Test Standard and Limit

10.1.1 Test Standard

FCC Part 15.247(e)

10.1.2 Test Limit

Test Item	Limit	Frequency Range(MHz)
Power Spectral Density	8dBm(in any 3 kHz)	2400~2483.5

10.2 Test Setup

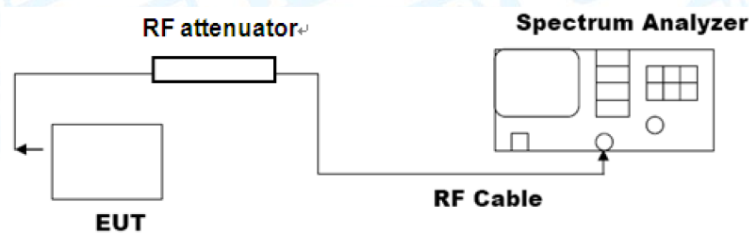

10.3 Test Procedure

● The following procedure shall be used if maximum peak conducted output power was used to determine compliance, and it is optional if the maximum conducted (average) output power was used to determine compliance:

- Set analyzer center frequency to DTS channel center frequency.
- Set the span to 1.5 times the DTS bandwidth.
- Set the RBW to $3\text{ kHz} \leq \text{RBW} \leq 100\text{ kHz}$.
- Set the VBW $\geq [3 * \text{RBW}]$.
- Detector = peak.
- Sweep time = auto couple.
- Trace mode = max hold.
- Allow trace to fully stabilize.
- Use the peak marker function to determine the maximum amplitude level within the RBW.
- If measured value exceeds requirement, then reduce RBW (but no less than 3 kHz) and repeat.

10.4 Deviation From Test Standard

No deviation

10.5 Antenna Connected Construction

Please refer to the description of test mode.

10.6 Test Data

Please refer to the external appendix report of BLE.



11. Antenna Requirement

11.1 Test Standard and Limit

11.1.1 Test Standard

FCC Part 15.203

11.1.2 Requirement

An intentional radiator shall be designed to ensure that no antenna other than that furnished by the responsible party shall be used with the device. The use of a permanently attached antenna or of an antenna that uses a unique coupling to the intentional radiator shall be considered sufficient to comply with the provisions of this Section. The manufacturer may design the unit so that a broken antenna can be replaced by the user, but the use of a standard antenna jack or electrical connector is prohibited.

11.2 Deviation From Test Standard

No deviation

11.3 Antenna Connected Construction

The gains of the antenna used for transmitting is 2.21dBi, and the antenna de-signed with permanent attachment and no consideration of replacement. Please see the EUT photo for details.

11.4 Test Data

The EUT antenna is a PCB Antenna. It complies with the standard requirement.

Antenna Type
<input checked="" type="checkbox"/> Permanent attached antenna
<input type="checkbox"/> Unique connector antenna
<input type="checkbox"/> Professional installation antenna



Attachment A-- Conducted Emission Test Data

Temperature:	28°C	Relative Humidity:	51%
Test Voltage:	AC 120V/60Hz		
Terminal:	Line		
Test Mode:	Mode 1		
Remark:	Only worse case is reported.		

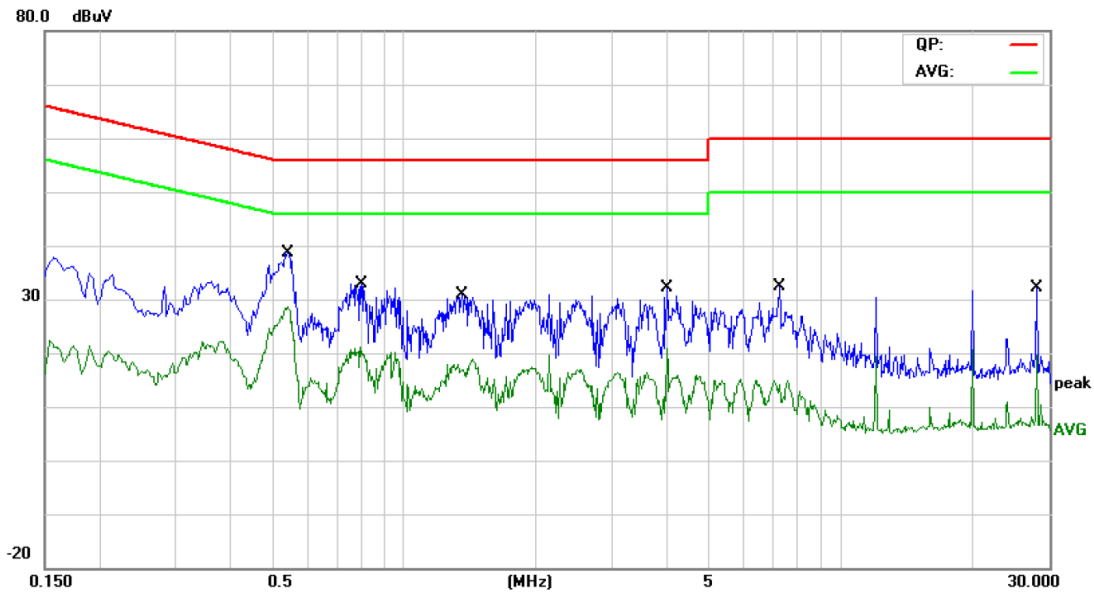

No.	Mk.	Freq. MHz	Reading Level dBuV	Correct Factor dB	Measure- ment dBuV	Limit dBuV	Over dB	Detector
1		0.5420	23.95	11.48	35.43	56.00	-20.57	QP
2	*	0.5420	16.44	11.48	27.92	46.00	-18.08	AVG
3		0.7980	16.32	11.34	27.66	56.00	-28.34	QP
4		0.7980	8.14	11.34	19.48	46.00	-26.52	AVG
5		1.3580	13.81	10.97	24.78	56.00	-31.22	QP
6		1.3580	4.92	10.97	15.89	46.00	-30.11	AVG
7		4.0020	17.96	10.15	28.11	56.00	-27.89	QP
8		4.0020	10.70	10.15	20.85	46.00	-25.15	AVG
9		7.2460	10.84	10.10	20.94	60.00	-39.06	QP
10		7.2460	-0.96	10.10	9.14	50.00	-40.86	AVG
11		28.0180	16.39	10.69	27.08	60.00	-32.92	QP
12		28.0180	7.03	10.69	17.72	50.00	-32.28	AVG

Remark:

1. Corr. Factor (dB) = LISN Factor (dB) + Cable Loss (dB)
2. Margin (dB) = QuasiPeak/Average (dBuV) - Limit (dBuV)



Temperature:	28°C	Relative Humidity:	51%
Test Voltage:	AC 120V/60Hz		
Terminal:	Neutral		
Test Mode:	Mode 1		
Remark:	Only worse case is reported.		

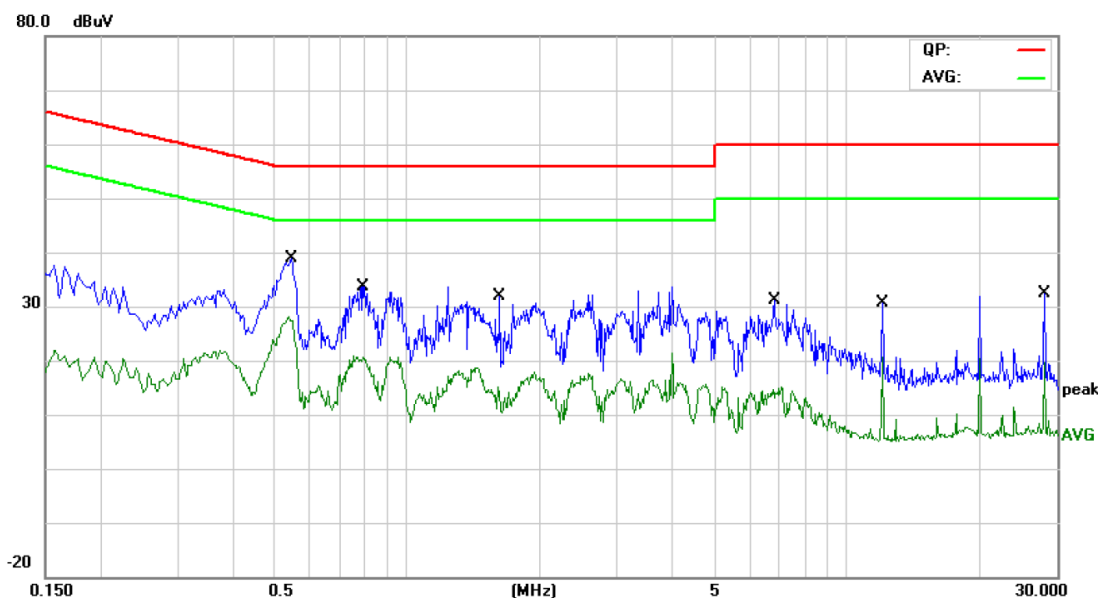

No.	Mk.	Freq. MHz	Reading Level dBuV	Correct Factor dB	Measure- ment dBuV	Limit dBuV	Over dB	Detector
1		0.5460	23.19	11.49	34.68	56.00	-21.32	QP
2	*	0.5460	15.91	11.49	27.40	46.00	-18.60	AVG
3		0.7940	16.40	11.37	27.77	56.00	-28.23	QP
4		0.7940	8.42	11.37	19.79	46.00	-26.21	AVG
5		1.6260	9.48	10.74	20.22	56.00	-35.78	QP
6		1.6260	-0.88	10.74	9.86	46.00	-36.14	AVG
7		6.8300	8.41	10.02	18.43	60.00	-41.57	QP
8		6.8300	-0.50	10.02	9.52	50.00	-40.48	AVG
9		12.0100	16.01	10.23	26.24	60.00	-33.76	QP
10		12.0100	9.24	10.23	19.47	50.00	-30.53	AVG
11		28.0220	17.45	10.64	28.09	60.00	-31.91	QP
12		28.0220	8.60	10.64	19.24	50.00	-30.76	AVG

Remark:

1. Corr. Factor (dB) = LISN Factor (dB) + Cable Loss (dB)
2. Margin (dB) = QuasiPeak/Average (dBuV) - Limit (dBuV)



Attachment B--Unwanted Emissions Data

---Radiated Unwanted Emissions

9 KHz~30 MHz

From 9 KHz to 30 MHz: Conclusion: PASS

Note: The amplitude of spurious emissions which are attenuated by more than 20dB
Below the permissible value has no need to be reported.

30MHz~1GHz

Temperature:	24.3°C	Relative Humidity:	45%
Test Voltage:	DC 5V		
Ant. Pol.	Horizontal		
Test Mode:	Mode 2 TX 1Mbps Mode Channel 00		
Remark:	Only worse case is reported.		

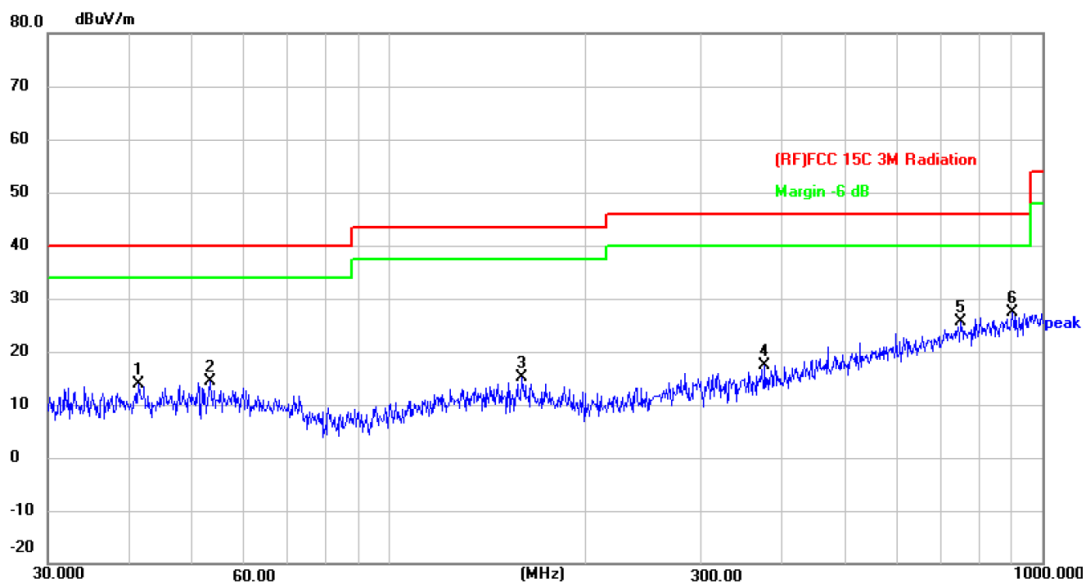

No.	Frequency (MHz)	Reading (dBuV)	Factor (dB/m)	Level (dBuV/m)	Limit (dBuV/m)	Margin (dB)	Detector	P/F
1	41.2765	36.78	-22.98	13.80	40.00	-26.20	peak	P
2	53.1313	37.21	-22.88	14.33	40.00	-25.67	peak	P
3	159.2251	36.62	-21.45	15.17	43.50	-28.33	peak	P
4	375.9385	36.51	-19.03	17.48	46.00	-28.52	peak	P
5	750.1083	36.45	-10.79	25.66	46.00	-20.34	peak	P
6 *	900.1474	36.00	-8.55	27.45	46.00	-18.55	peak	P

*:Maximum data x:Over limit !:over margin

Remark:

1. Corr. = Antenna Factor (dB/m) + Cable Loss (dB)
2. QuasiPeak (dBμV/m)= Corr. (dB/m)+ Read Level (dBμV)
3. Margin (dB) = QuasiPeak (dBμV/m)-Limit QPK(dBμV/m)



Temperature:	24.3°C	Relative Humidity:	45%
Test Voltage:	DC 5V		
Ant. Pol.	Vertical		
Test Mode:	Mode 2 TX 1Mbps Mode Channel 00		
Remark:	Only worse case is reported.		

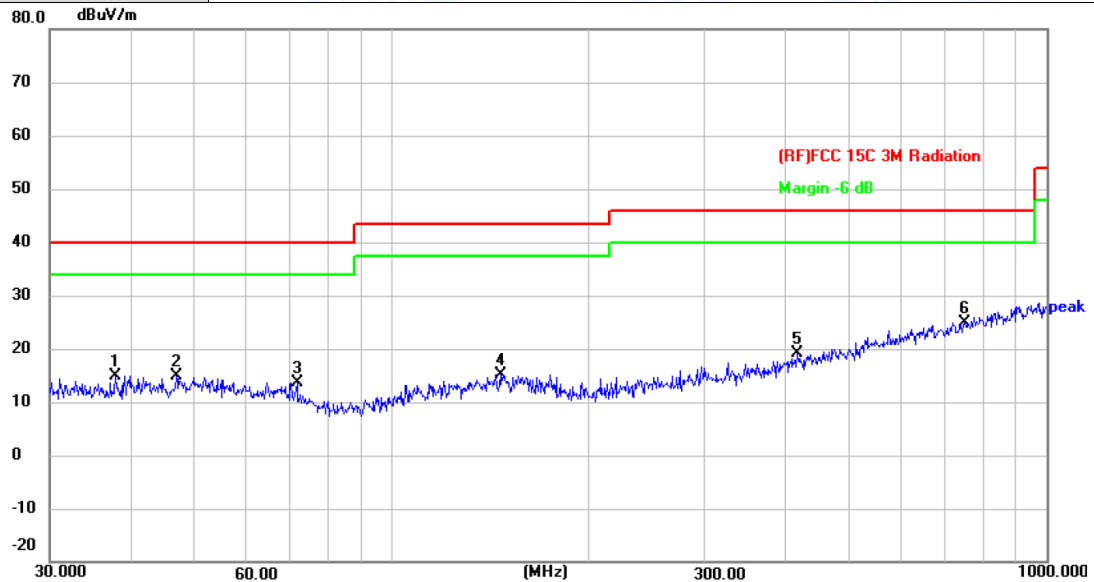

No.	Frequency (MHz)	Reading (dBuV)	Factor (dB/m)	Level (dBuV/m)	Limit (dBuV/m)	Margin (dB)	Detector	P/F
1	37.8121	38.04	-23.06	14.98	40.00	-25.02	peak	P
2	46.8303	37.47	-22.71	14.76	40.00	-25.24	peak	P
3	71.5806	38.36	-24.69	13.67	40.00	-26.33	peak	P
4	146.3735	37.06	-21.84	15.22	43.50	-28.28	peak	P
5	416.1791	37.07	-18.00	19.07	46.00	-26.93	peak	P
6 *	750.1083	35.65	-10.79	24.86	46.00	-21.14	peak	P

*:Maximum data x:Over limit !:over margin

Remark:

1. Corr. = Antenna Factor (dB/m) + Cable Loss (dB)
2. QuasiPeak (dBμV/m)= Corr. (dB/m)+ Read Level (dBμV)
3. Margin (dB) = QuasiPeak (dBμV/m)-Limit QPK(dBμV/m)



Above 1GHz

Temperature:	26°C	Relative Humidity:	54%
Test Voltage:	DC 5V		
Ant. Pol.	Horizontal		
Test Mode:	BLE(1Mbps) Mode TX 2402 MHz		

No.	Frequency (MHz)	Reading (dBuV)	Factor (dB/m)	Level (dBuV/m)	Limit (dBuV/m)	Margin (dB)	Detector	P/F
1 *	4803.831	40.48	1.38	41.86	54.00	-12.14	AVG	P
2	4803.935	50.08	1.38	51.46	74.00	-22.54	peak	P

Remark:

1. Corr. = Antenna Factor (dB/m) + Cable Loss (dB)
2. Peak/AVG (dBμV/m)= Corr. (dB/m)+ Read Level (dBμV)
3. Margin (dB) = Peak/AVG (dBμV/m)-Limit PK/AVG(dBμV/m)
4. The tests evaluated1-26.5GHz,The testing has been conformed to the 10th harmonic of the highest fundamental frequency.
5. No report for the emission which more than 20dB below the prescribed limit.

Temperature:	26°C	Relative Humidity:	54%
Test Voltage:	DC 5V		
Ant. Pol.	Vertical		
Test Mode:	BLE(1Mbps) Mode TX 2402 MHz		

No.	Frequency (MHz)	Reading (dBuV)	Factor (dB/m)	Level (dBuV/m)	Limit (dBuV/m)	Margin (dB)	Detector	P/F
1 *	4803.628	40.48	1.38	41.86	54.00	-12.14	AVG	P
2	4803.877	50.24	1.38	51.62	74.00	-22.38	peak	P

Remark:

1. Corr. = Antenna Factor (dB/m) + Cable Loss (dB)
2. Peak/AVG (dBμV/m)= Corr. (dB/m)+ Read Level (dBμV)
3. Margin (dB) = Peak/AVG (dBμV/m)-Limit PK/AVG(dBμV/m)
4. The tests evaluated1-26.5GHz,The testing has been conformed to the 10th harmonic of the highest fundamental frequency.
5. No report for the emission which more than 20dB below the prescribed limit.



Temperature:	26°C	Relative Humidity:	54%
Test Voltage:	DC 5V		
Ant. Pol.	Horizontal		
Test Mode:	BLE(1Mbps) Mode TX 2440 MHz		

No.	Frequency (MHz)	Reading (dBuV)	Factor (dB/m)	Level (dBuV/m)	Limit (dBuV/m)	Margin (dB)	Detector	P/F
1 *	4879.883	40.72	1.54	42.26	54.00	-11.74	AVG	P
2	4879.953	49.89	1.54	51.43	74.00	-22.57	peak	P

Remark:

1. Corr. = Antenna Factor (dB/m) + Cable Loss (dB)
2. Peak/AVG (dBμV/m) = Corr. (dB/m) + Read Level (dBμV)
3. Margin (dB) = Peak/AVG (dBμV/m) - Limit PK/AVG (dBμV/m)
4. The tests evaluated 1-26.5GHz, The testing has been conformed to the 10th harmonic of the highest fundamental frequency.
5. No report for the emission which more than 20dB below the prescribed limit.

Temperature:	26°C	Relative Humidity:	54%
Test Voltage:	DC 5V		
Ant. Pol.	Vertical		
Test Mode:	BLE(1Mbps) Mode TX 2440 MHz		

No.	Frequency (MHz)	Reading (dBuV)	Factor (dB/m)	Level (dBuV/m)	Limit (dBuV/m)	Margin (dB)	Detector	P/F
1 *	4880.383	40.74	1.55	42.29	54.00	-11.71	AVG	P
2	4880.421	47.83	1.55	49.38	74.00	-24.62	peak	P

Remark:

1. Corr. = Antenna Factor (dB/m) + Cable Loss (dB)
2. Peak/AVG (dBμV/m) = Corr. (dB/m) + Read Level (dBμV)
3. Margin (dB) = Peak/AVG (dBμV/m) - Limit PK/AVG (dBμV/m)
4. The tests evaluated 1-26.5GHz, The testing has been conformed to the 10th harmonic of the highest fundamental frequency.
5. No report for the emission which more than 20dB below the prescribed limit.



Temperature:	26°C	Relative Humidity:	54%
Test Voltage:	DC 5V		
Ant. Pol.	Horizontal		
Test Mode:	BLE(1Mbps) Mode TX 2480 MHz		

No.	Frequency (MHz)	Reading (dBuV)	Factor (dB/m)	Level (dBuV/m)	Limit (dBuV/m)	Margin (dB)	Detector	P/F
1 *	4959.801	40.66	1.81	42.47	54.00	-11.53	AVG	P
2	4960.225	48.62	1.81	50.43	74.00	-23.57	peak	P

Remark:

1. Corr. = Antenna Factor (dB/m) + Cable Loss (dB)
2. Peak/AVG (dBμV/m)= Corr. (dB/m)+ Read Level (dBμV)
3. Margin (dB) = Peak/AVG (dBμV/m)-Limit PK/AVG(dBμV/m)
4. The tests evaluated1-26.5GHz,The testing has been conformed to the 10th harmonic of the highest fundamental frequency.
5. No report for the emission which more than 20dB below the prescribed limit.

Temperature:	26°C	Relative Humidity:	54%
Test Voltage:	DC 5V		
Ant. Pol.	Vertical		
Test Mode:	BLE(1Mbps) Mode TX 2480 MHz		

No.	Frequency (MHz)	Reading (dBuV)	Factor (dB/m)	Level (dBuV/m)	Limit (dBuV/m)	Margin (dB)	Detector	P/F
1 *	4959.854	40.65	1.81	42.46	54.00	-11.54	AVG	P
2	4959.914	50.22	1.81	52.03	74.00	-21.97	peak	P

Remark:

1. Corr. = Antenna Factor (dB/m) + Cable Loss (dB)
2. Peak/AVG (dBμV/m)= Corr. (dB/m)+ Read Level (dBμV)
3. Margin (dB) = Peak/AVG (dBμV/m)-Limit PK/AVG(dBμV/m)
4. The tests evaluated1-26.5GHz,The testing has been conformed to the 10th harmonic of the highest fundamental frequency.
5. No report for the emission which more than 20dB below the prescribed limit.

-----END OF REPORT-----

