



AS 200E

User Manual

Installation and Operation

Notice

The information in this document is subject to change. Neither Alliedstar nor any of its subsidiaries shall be liable for errors contained herein or for incidental damages in conjunction with the furnishing, performance, or use of this material. No part of this publication may be reproduced without the permission of Alliedstar.

We recommend that you thoroughly familiarize yourself with this Guide in order to make the most effective use of your system.



WARNING: We recommend that you consult the “AS 200E User Manual - Safety, Regulatory and Technical Specification” before using the AS 200E system.

All trademarks and registered trademarks are the property of their respective holders.

The AS 200E is intended for professional use only.

U.S. Federal law restricts this device to sale by or on the order of a dentist.

Manual Name: AS 200E User Manual: Installation and Operation

Part Number: DD0070

Revision: 1.4

Date: 2022-09



Contents

1	Safety Information.....	1	Audio Prompts.....	27
	Conventions in This Manual	1	Preparing the Teeth	28
2	AS 200E Overview.....	2	Preparing the Scanner	28
	AS 200E Components	2	Starting Scanning.....	29
	System Components.....	3	Scanning Approach.....	29
	Charging the Battery.....	3	Scanning Protocol	30
	Wireless Connection.....	6		
	Status Indicator Overview	7	6	Acquiring a 3D Model Using the
	AS 200E Charging Holder Overview.....	7		Common Scan Workflow.....
	AS 200E Packing List	8		Scanning the Upper and Lower Jaw
3	AS 200E Software Overview.....	8		31
	Computer System Requirements.....	8		Scanning the Buccal Bite Registration .
	ScanPro Interface Overview	9		34
	Toolbar Overview	10		Refining and Checking the 3D Model ..
	Option Menu Overview	15		35
	Import/Export Scan Data Overview.....	15		Completing and Saving the 3D Model .
	Scan History Dialog Overview.....	15		37
	Save To Scan History Overview	15	7	Acquiring a 3D Model Using the
	If users need to save scan data to Scan			Scan Body Workflow
	history after scanning,you can click this			Scanning the Upper and Lower Jaw
	button.....	15		38
	Preference Dialog Overview	15		Scanning the Buccal Bite Registration .
	About Dialog Overview.....	18		41
4	Setting Up the Scanner.....	19		Marking the Implant Areas.....
	Setting Up the Scanner	19		42
	Using the Scanner Charging Holder.....	20		Installing and Scanning the Scan Body
	Installing the Desktop Charging Holder	20		43
	Installing the Wall Mount Charging			Refining and Checking the 3D Model ..
	Holder.....	22		46
5	Getting Started	25		Completing and Saving the 3D Model .
	Accessing the ScanPro User Interface	25		47
			8	Acquiring a 3D Model Using the
				Preparation Workflow.....
				Import the scanned data before
				preparing
				49
				Scan the Preparation Areas
				50
				Refining and Checking the 3D Model ..
				53
				Completing and Saving the 3D Model .
				55
			9	Maintenance
				56
				Cleaning, Disinfecting, and Sterilizing.....
				56
			10	Troubleshooting.....
				57
				AS 200E Troubleshooting Instructions.....
				57

1 Safety Information

Conventions in This Manual

The following special messages emphasize information or indicate potential risk to personnel or equipment:



WARNING: Warns you to avoid injury to yourself or others by following the safety instructions precisely.



CAUTION: Alerts you to a condition that might cause serious damage.



Important: Alerts you to a condition that might cause problems.



Tip: Provides extra information and tips.

2 AS 200E Overview

AS 200E is designed to acquire 3D models in the followings:

1. Upper jaw
2. Lower jaw
3. Buccal bite registration

AS 200E Components

AS 200E consists of the following parts:

1. Reusable tip
Press once to start scanning
Press again to stop scanning
3. Mode indicators



Upper jaw scan mode



Lower jaw scan mode



Buccal bite registration mode

4. Mode switch button
Press this button to switch between different modes
5. Status Indicator
The light is breathing: not connect
The light is blinking: connecting
The light is bright: successfully connect
6. Battery indicator
Solid green: battery level higher than 50%
Solid yellow: battery level between 20% and 50%
Blinking yellow: battery level lower than 20%
Breathing green: charging and battery level higher than 50%
Breathing yellow: charging and battery level lower than 50%



Solid green: finished charging

7. Charging holder

8. USB cable

System Components

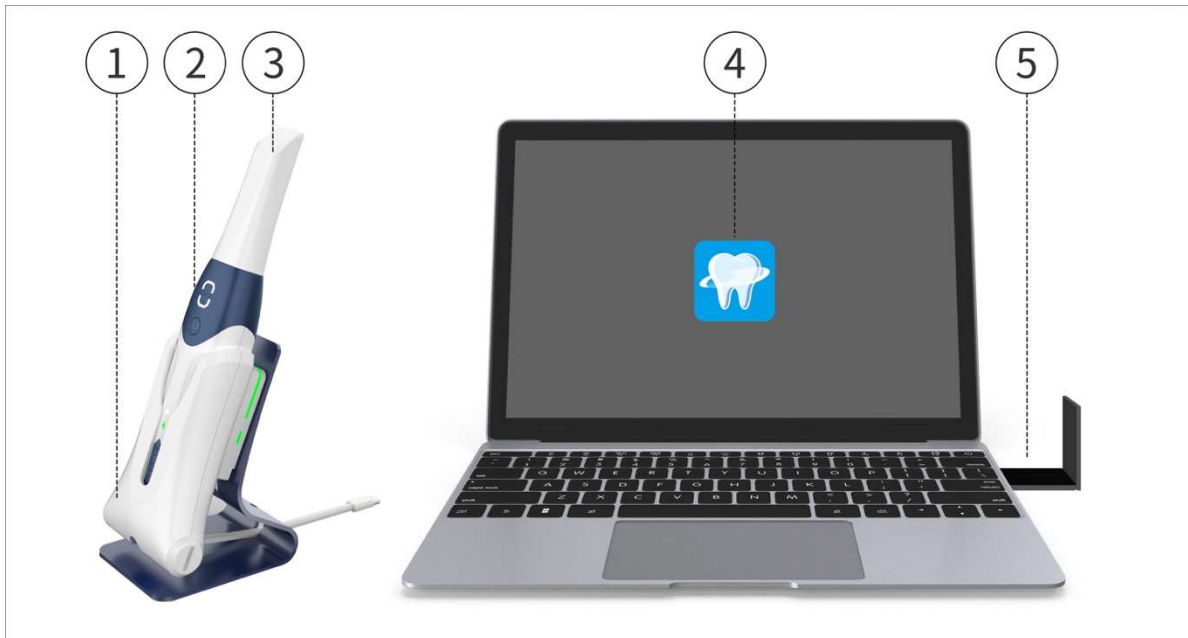

1. Charging holder

2. Handpiece

3. Tip

4. ScanPro

5. Wireless adapter

Charging the Battery

A fully charged battery can support up to 2 hours of scan time. When the battery indicator flashes yellow, it means the battery is low and needs to be charged in time. To charge, the scanner needs to be inserted into the charging holder.



To use the charging holder, the charging holder must be connected to a USB Type C power source.



You can also continue to use the scanner by replacing the battery, follow these steps to replace the low battery from the scanner.

1. Turn the battery cover with a coin to unlock.



2. Take out the low battery and insert a charged one.



WARNING: Please change the battery Li-18650-3.6V,3500mAh as per specified by Alliedstar.

3. Close the battery cover by turning it to lock.



4. The charging holder holds a spare battery and keeps the battery level at approximately 80%. Open the battery cover by turning it to unlock and you will be able to take the battery out.

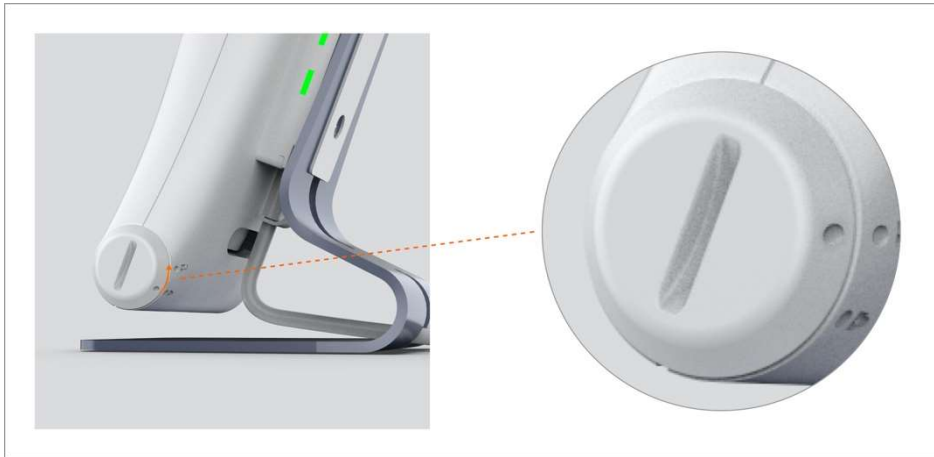

Wireless Connection

The AS 200E scanner connects to the ScanPro software through a wireless connection. Before using the AS 200E scanner, a compatible wireless adapter needs to be connected to the computer that runs the ScanPro software.

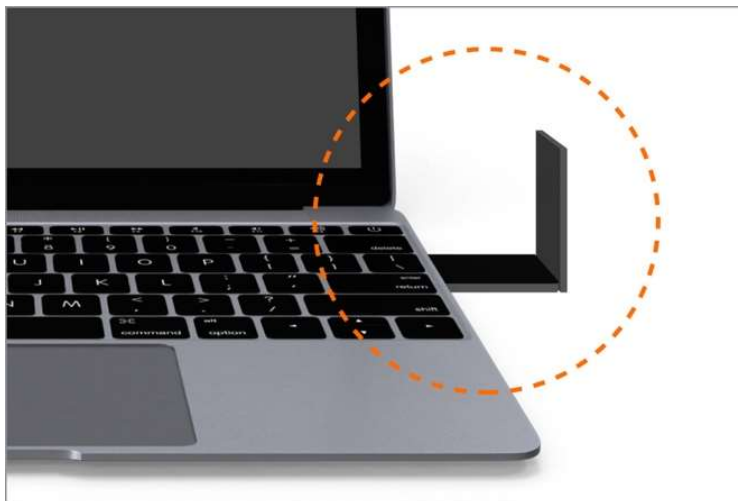

Tip: Expand the wireless adapter to maximize the network signal strength.



After the compatible wireless adapter is connected, select the scanner you want to connect from the Scanner list window at the bottom right of the software.



Indicates a wireless scanner







Indicates a wired scanner

Scanner List	
 AS100-CKAA0025	
 AS200E-DEAB0018	

Status Indicator Overview

The relationship between the status of the scanner and the status indicator is as follows:

Scanner Status	Status Indicator
Power off	Off 
Connected	Solid white 
Start up	Flashing 
Sleep	Breathing light 

AS 200E Charging Holder Overview

Place the scanner in the charging holder when you are not using it.



The scanner will automatically shut down if it is idle for more than 3 minutes. If you need to use it again, press any button on the scanner, or take it out of the charging holder.

AS 200E Packing List

Part	Quantity
Scanner handpiece	1
Reusable tip	4
Charging holder	1
Screw pack for charging holder	1
AS 200E User Manual: Installation and Operation	1
AS 200E User Manual: Safety, Regulatory and Technical Specifications	1

3 AS 200E Software Overview

Computer System Requirements

For the computer system requirements, see the **“AS 200E User Manual: Safety, Regulatory and Technical Specifications”**.



It is **MANDATORY** to check that your computer system configuration is compatible with the computer system requirements for the AS 200E software.

ScanPro Interface Overview

The AS 200E scanner operates with ScanPro software. The ScanPro interface enables you to acquire 3D models in two ways:

1. Partial arch scan: Several teeth in the preparation area on both the upper and lower jaws, and buccal bite registration.
2. Full arch scan: Upper jaw, lower jaw, and buccal bite registration.

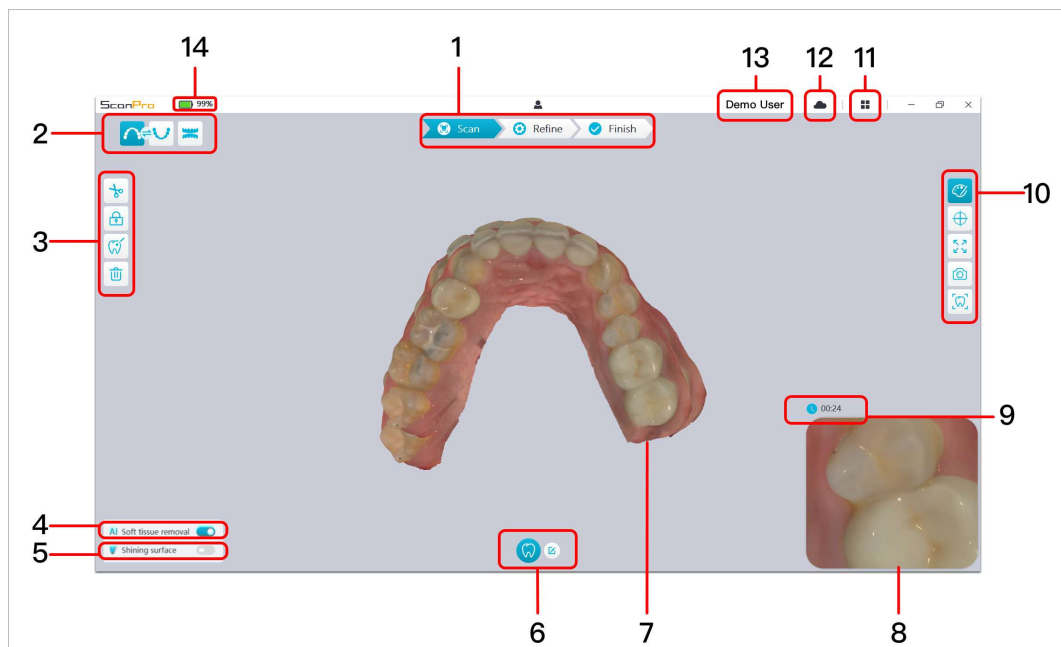

1. **Acquisition Step:** Displays the current step in the acquisition process.
2. **Jaw/Bite Switch:** Enables you to select the upper jaw, lower jaw, or buccal bite registration.
3. **Image Toolbar:** Enables you to select and manage 3D model.
4. **Soft tissue removal Switch:** Enables you to automatically remove soft tissue.
5. **Shining surface:** When scanning the highlight metal, you can turn on the button to scan
6. **Workflow Toolbar:** Enables you to choose general scan, preparation scan and scan body scan.
7. **3D Model Display Screen:** Displays the 3D model created from the scan.
8. **Video Preview Screen:** Displays live video when scanning, or the scanner status when not scanning.
9. **Scanning Time:** Displays the total scanning duration of the current case.
10. **Display Toolbar:** Enables you to change how the 3D model is displayed.
11. **Option Menu:** Access the system configuration and version information.
12. **DataHub Service:** You can view the cloud service status.

13. Login Menu: Enables you to log in, switch users and log out.

14. Battery: Displays the battery level of wireless scanner.

Toolbar Overview

Acquisition Step Toolbar



Scan

Scan button: Enables you to scan the upper and lower arch, and the buccal bite registration.



Refine

Refine button: Refines the acquired 3D model, and enables you to use various tools to check the refined results.



Finish

Finish button: complete the case information and save the scan results.

Jaw/Bite Switch Toolbar



Upper Jaw button: Acquires a 3D model of the upper jaw.



Lower Jaw button: Acquires a 3D model of the lower jaw.



Buccal Bite Registration button: Acquires a 3D model of the bite.



Switch Upper/Lower Jaw button: Changes the acquisition mode from upper to lower or vice versa, if you accidentally scan teeth on the wrong jaw.

Image Toolbar



Cut button: draw a curve to delete unnecessary data.



Undo last cut



Return to the upper level tool (icon on the left)



Lock button: Enables you to select and lock an area on the model to prevent it from being updated by additional scanning.



Unlock the last locked area



Return to the upper level tool (icon on the left)



Mark tooth button: Mark one or more preparation / implant areas.



Delete marked teeth



Return to the up-level toolbar (icon on the left)



Delete button: Delete all models from the current case.



Quadrant Snapshot button: Displays a preview of five 2D images showing different views of the model.



Transparency button: Set the transparency of the scanned model.

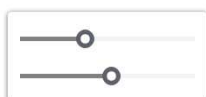



Undercut check button: View the undercut areas on the surface of the preparation.



Occlusion analysis button: Analyze the occlusion space.



Measurement button: Measure the distance from the specified area of the section.



Margin line button: Automatically or manually create margin lines, and edit margin lines.

Display Toolbar



True Color button: When selected, displays the 3D model in the actual color of the patient's hard and soft tissues. When deselected, displays the 3D model in monochrome.



Show 3D center button: When selected, the rotation center will be displayed when rotating the 3D model.



Zoom fit button: Scales the 3D model to the best size to fit the display region.



View orientation button: Displays a list of views.



Front view



Back view



Left view



Right view





Top view



Bottom view

 Return to the up-level toolbar (icon on the right)

 **Snapshot** button: Takes a snapshot of the 3D model as it appears on your screen.

 **Intraoral Camera** button: Enables you to select 2D intraoral images.

Workflow Toolbar

 **Common scan** button: Enables you to acquire a 3D model of the upper jaw, lower jaw, and the buccal bite.

 **Config Scan** button: Edit acquisition type.

 **Add preparation scan** button: Add a preparation scan step.

 **Add scan body** button: Add a scan body scan step.

 **Preparation** button: Activate the preparation scan.

 **Scan body** button: Activate the scan body scan.

Option Menu

 **Option menu** button: Enables you to access Import/Export scan data, Scan history, Preference and About dialog.

Scanner Status Icons

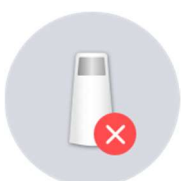
 Scanner tip is not detected

 Scanner is connecting



Scanner is overheating



Scanner is in the charging holder



Scanner is in sleep mode



Scanner is in pause state

Option Menu Overview

Import/Export Scan Data Overview

The import/export scan data menus allow users to export the current scan data to a specified folder, and import it later to continue scanning or perform other operations.



If you need to continue scanning after importing the previously saved scan data, you must ensure that the scan data is acquired by the same scanner currently connected, otherwise you will not be able to perform subsequent scans on the imported data.

Scan History Dialog Overview

The Scan History dialog allows users to import automatically saved scan history data. Based on different user settings, the scan history data is retained for up to 30 days. In the scan history dialog, you can search data by ID or name. To import or manage the selected record, right-click the entry, and then select "Open", "Lock/Unlock" or "Delete".

Open: Import the selected scan history data.

Lock/Unlock: Lock or unlock the selected scan history. The locked scan history records will not be cleared after the storage period expires.

Delete: Delete the selected scan history data.



If you need to continue scanning after importing the previously saved scan data, you must ensure that the scan data is acquired by the same scanner currently connected, otherwise you will not be able to perform subsequent scans on the imported data.

Save To Scan History Overview

If users need to save scan data to Scan history after scanning, you can click this button.

Preference Dialog Overview

The Preferences dialog enables you to select the software and scanner settings.

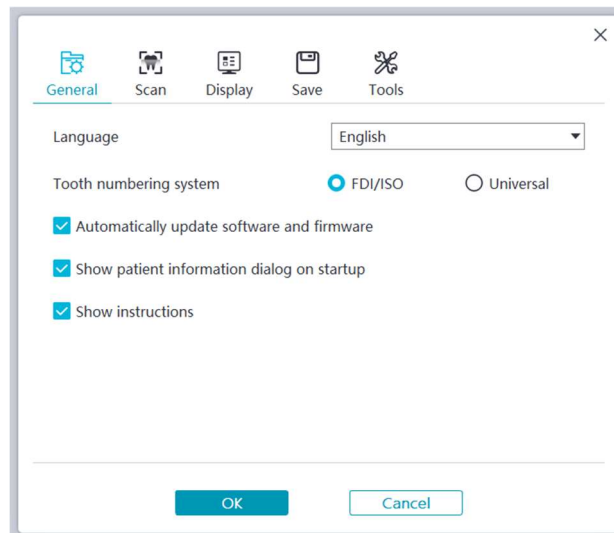

1. **Language:** Select the user interface language.
2. **Tooth numbering system:** Select the FDI/ISO or Universal as the tooth numbering system.
3. **Automatically update software and firmware:** When selected, the software will automatically prompt of new versions.
4. **Show patient information dialog on startup:** When selected, the patient information dialog will pop up when ScanPro opens.
5. **Show instructions:** When selected, the software will show tutorial animation.

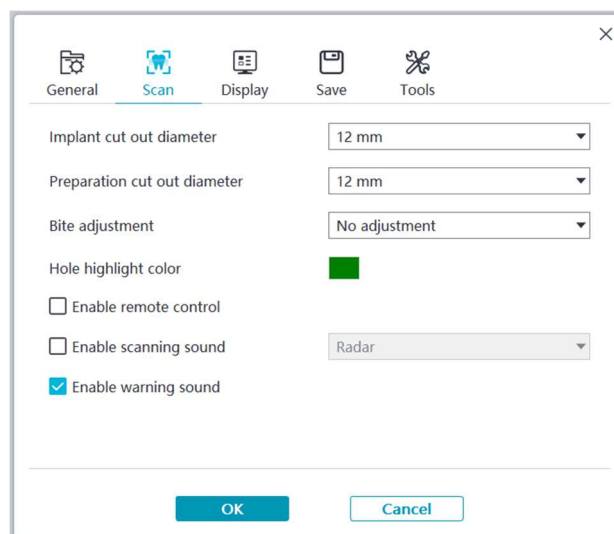

1. **Implant cut out diameter:** Set the diameter of the automatic cut out areas in implant mode, it is recommended to choose a value slightly larger than the diameter of the scan body used.
2. **Preparation cut out diameter:** Set the diameter of the automatic cut out areas in preparation scan mode, it is recommended to choose a value slightly larger than the preparation diameter.
3. **Bite adjustment:** Set whether to adjust the bite result to avoid intersection.
4. **Hole highlight color:** Fill the holes in the model with the specified color after refining.
5. **Enable remote control:** When selected, the scanned 3D model can be rotated by rotating the scanner after the scanning is stopped.

6. **Enable scanning sound:** When selected, a sound will be continuously played when you are successfully scanning (if your computer does not have speakers, this option will not take effect).
7. **Enable warning sound:** When selected, a warning sound will be played if the scanning duration exceeds the recommended thresholds, a strong light is detected, or the scanning performance is declined (if your computer does not have speakers, this option will not take effect).

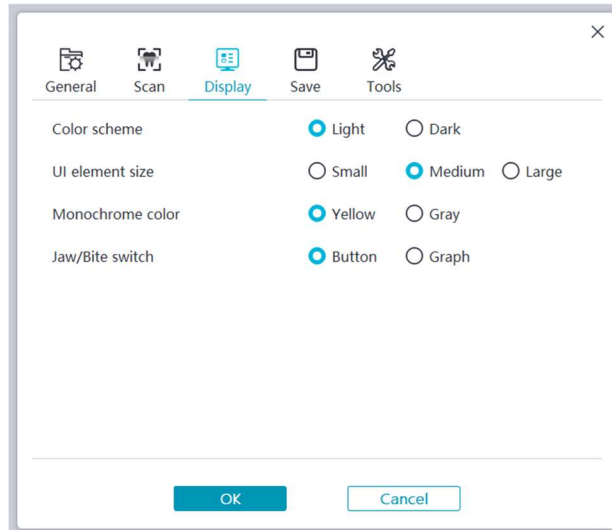

1. **Color scheme:** Select the color scheme of the user interface.
2. **UI element size:** Select the size of interface icons to adapt to different screen resolutions.
3. **Monochrome color:** Select the color when displaying the 3D model in monochrome.
4. **Jaw/Bite switch:** Select the style of jaw/bite switch.

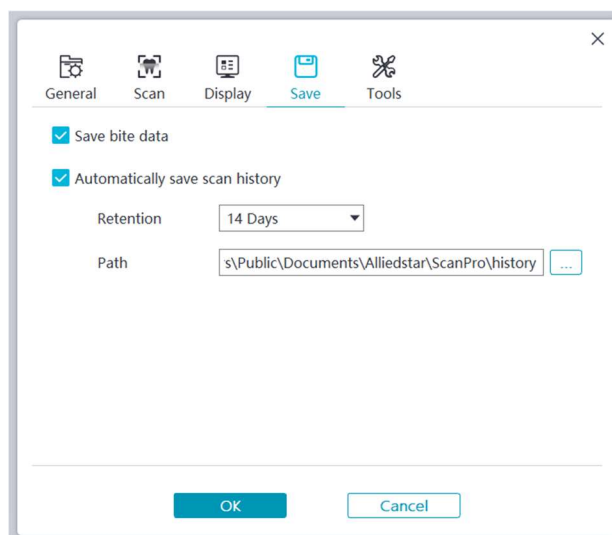

1. **Save bite data:** When selected, save the bite images to separate files.
2. **Automatically save scan history:** When selected, scan history is automatically saved when the software is closed. When this option is enabled, the user can customize the number of days and the path to save the scan history.

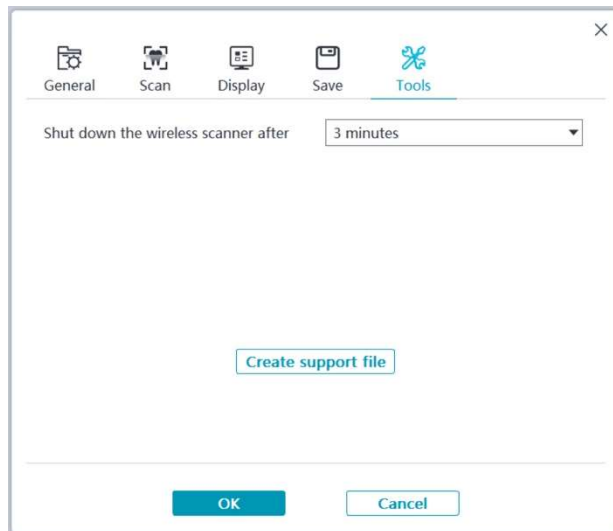

1. **Shut down the wireless scanner after:** User can customize the time of automatic shutdown of the wireless scanner.
2. **Create support file:** Export software and firmware logs.

About Dialog Overview

The About dialog displays software version, firmware version and scanner serial number information.

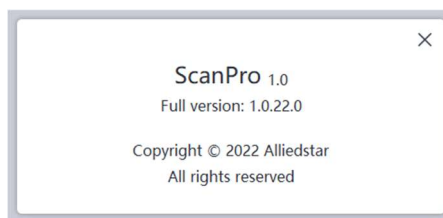

4 Setting Up the Scanner

Setting Up the Scanner

To set up the scanner, follow these steps:

1. Visit www.allied-star.com and download the installation file and user manual according to the product model.
2. Double-click the software installation file SetupScanPro_x.x.x.x.exe (where x.x.x.x represents the internal version number of the ScanPro software).
3. Choose a language from the drop-down list and click Ok to install.
4. Follow the instructions on the screen to complete the installation.
5. Firmly slide one of the tips onto the end of the scanner.

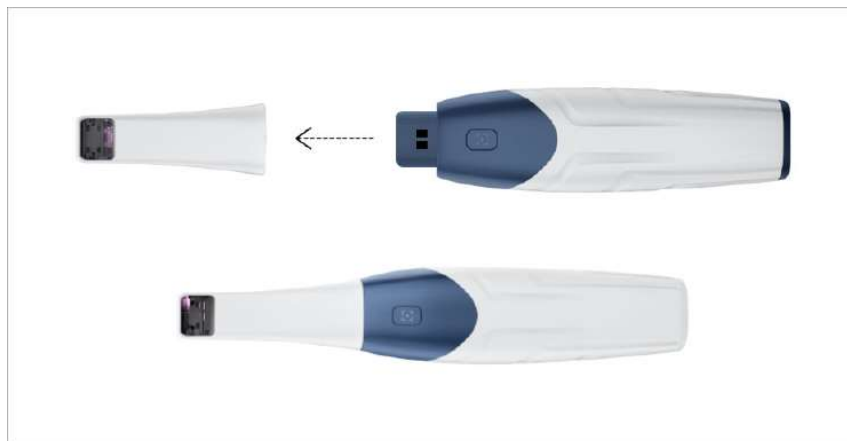

6. Short press any button to start the scanner.
7. After the scanner is powered on, open the software and connect the scanner through the wireless network.

Using the Scanner Charging Holder

The charging holder can function either as a desktop charging holder or a wall mount charging holder.

Installing the Desktop Charging Holder

To place the charging holder on a desktop, follow these steps:

1. Select a clean surface area.
2. Insert one end of the charging cable into the bottom of the charger.



3. Insert the charger with the connected charging cable into the base.



4. Insert the charging cable into the holder bracket.

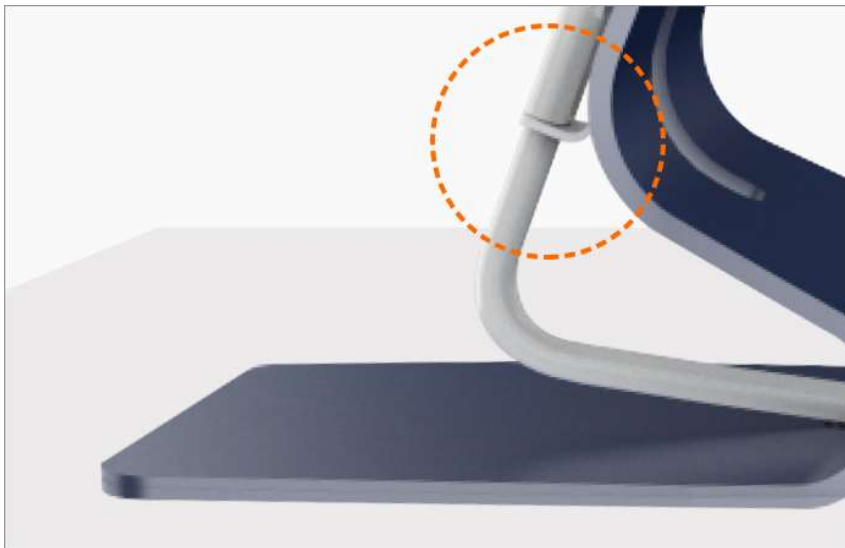

5. Pass the other end of the cable through the hole reserved on the base.



6. Insert the scanner into the charging holder.



Installing the Wall Mount Charging Holder

To use the charging holder as a wall mount holder, follow these steps:

1. Select an area that you can access easily.
2. Insert screws through the holes in the holder bracket to affix it to a solid surface.

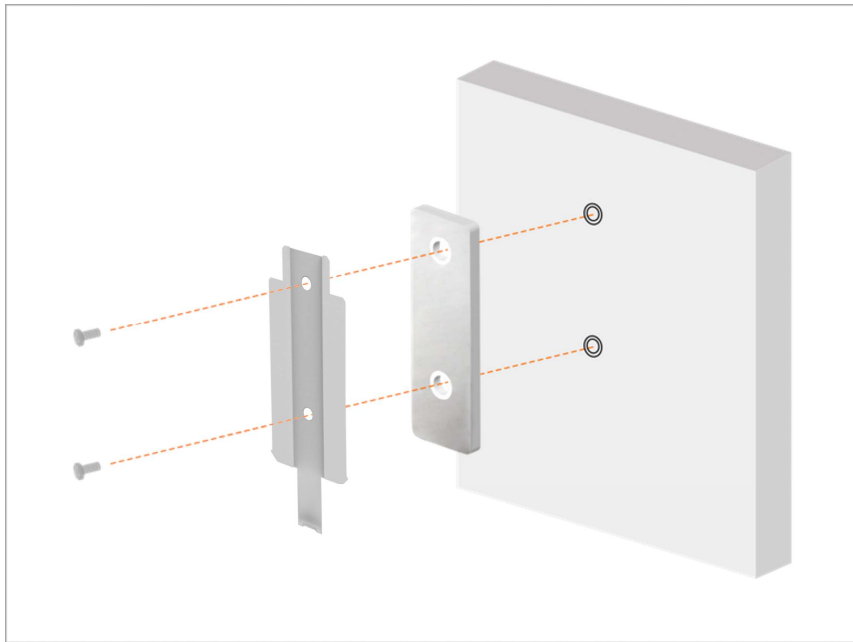

3. Insert one end of the charging cable into the bottom of the charger.



4. Insert the charging holder into the holder bracket.

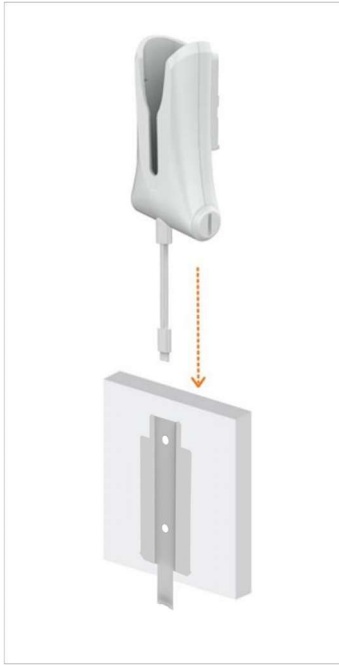

5. Insert the scanner into the charging holder.

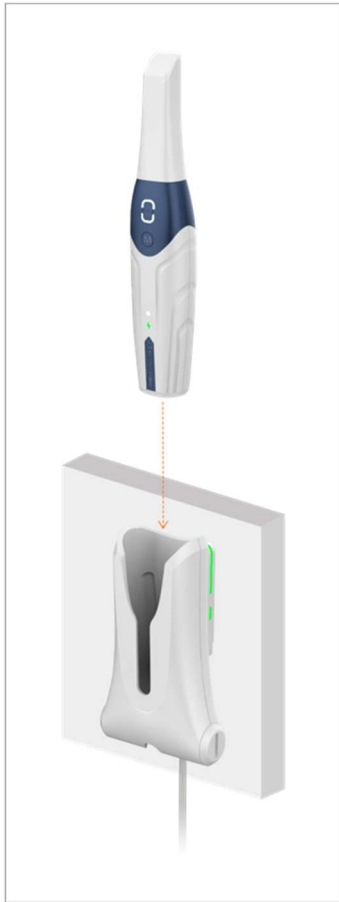

If the charging holder is not properly installed, there is a risk that the charging holder can fall off the wall, resulting in damage to the scanner.

5 Getting Started

Accessing the ScanPro User Interface

To access the ScanPro user interface, follow these steps:

1. Double-click the  icon from your desktop.
2. ScanPro will automatically pop up the login window.

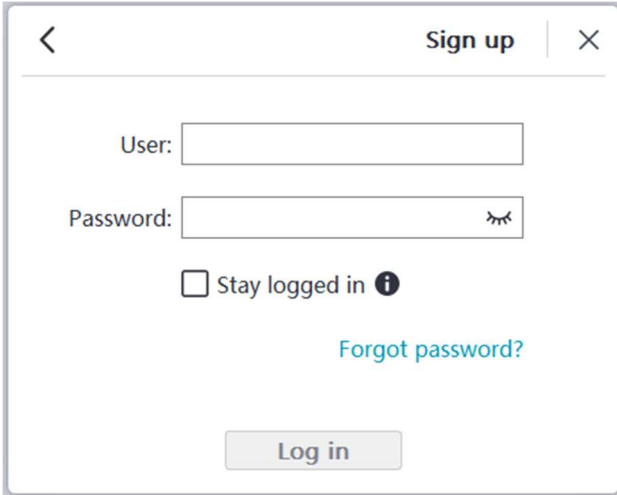

3. Click the **Sign up** button to register the organization, and complete the email verification.
4. Type your Alliedstar DataHub account information in the username and password fields, Click the **Log in** button.
5. The Patient Information dialog box will pop up.
6. Do one of the following:

Enter patient information and tooth number information, and click **OK**.
Click **Skip** and continue without patient information.

Patient Information ✕

ID: *

Name: *

Gender: Male Female

Age:

Comment:
0/200

Show this dialog on startup

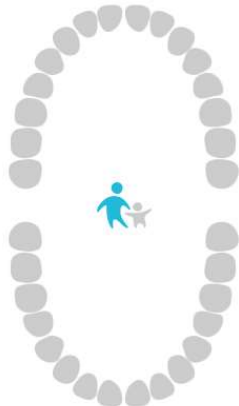

7. Click **Connect** button to connect wireless scanner in Scanner List.

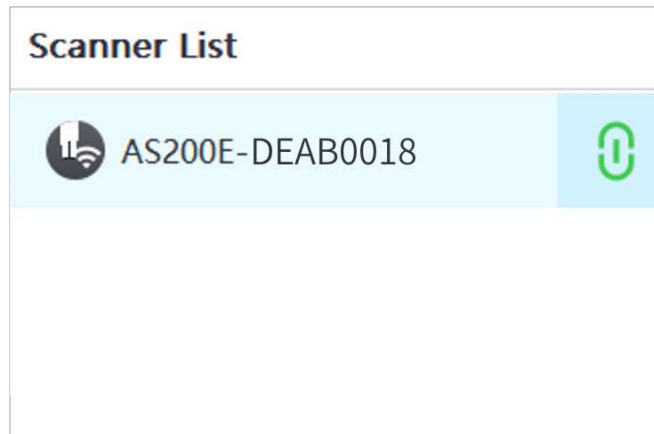

If the scanner is not activated, the device activation dialog will be displayed. Follow the instructions on the screen to complete device activation.

Patient Information ✕

ID: *

Name: *

Gender: Male Female

Age:

Comment:
0/200

Show this dialog on startup

8. Click the Option menu  button and select Preferences.

9. Customize the configuration options.

10. You can now start acquiring 3D models.

Audio Prompts

1. Scanning sound

When the **Enable scanning sound** option is enabled, your computer will play a continuous sound when you are successfully scanning. If the sound stops, it means the scan has stopped. If you need to continue, please return to the previous scanning area until the scanner resumes scanning and your computer plays a continuous sound. When a bite registration relationship is successfully scanned, your computer will also play a short sound.

2. Warning sound

If the cumulative scanning time of the current case exceeds the recommended threshold and your computer may not be able to maintain the peak scanning performance, your computer will play a short warning sound (if your computer does not have speakers, this option will not take effect).



To enable the audio prompts, your computer must have speakers.

Preparing the Teeth

1. If there is a preparation area, retract the gingiva by gingival restriction cords. And extract the cords just before scanning the preparation.
2. Before starting the scan, dry the teeth thoroughly.
3. During the scan, re-dry the teeth moderately.

Preparing the Scanner

The reusable tip attached to the scanner provides sanitary shield for patients. **Always disinfect the body of the scanner and perform high-level disinfection or sterilization on the reusable tip after each use.**



Scanner tips received from the manufacturer are **NOT** sterilized. You must sterilize the tips before the first use.



For detailed information on cleaning, disinfection and sterilization, please refer to the “AS 200E User Manual: Safety, Regulatory and Technical Specifications”.



Avoid any liquid from leaking into the air outlet near the tip mount or the air inlet at the rear of the scanner (see the figure below), otherwise the scanner may be damaged.

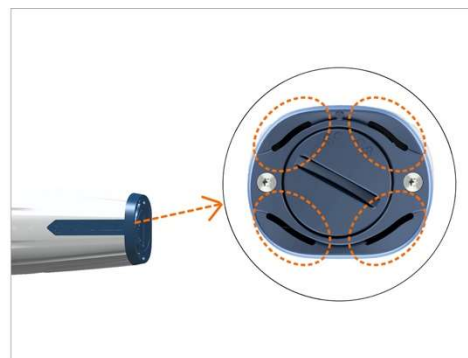
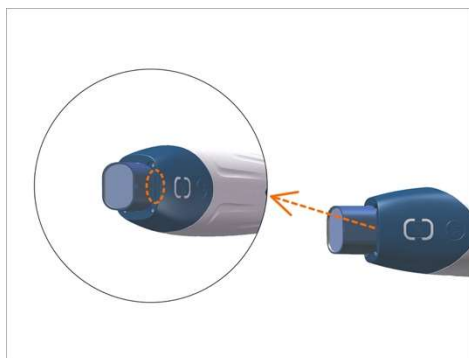

To prepare the scanner, follow these steps:

- Make sure the lens window at the base of the scanner is clean by wiping it with a moist, lint-free cloth or lens tissue.
- Slide the tip onto the scanner as shown below.

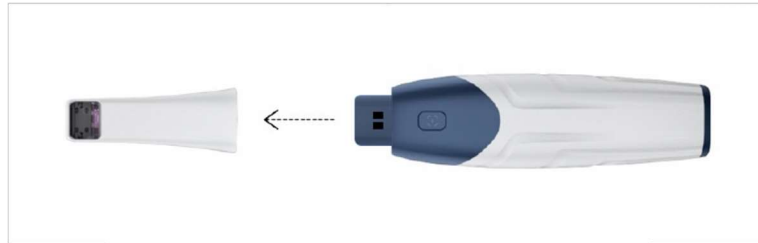

Starting Scanning

To start scanning, place the tip of the scanner on the surface of the tooth to stabilize the scanner and press the Start Scan button. Wait until a 3D model appears on the 3D model display screen, and then slowly move it along the arch at 0-5mm from the teeth.



During the scanning process, adjust the surgical light to keep the light away from the patient's mouth to avoid interference with the scanner.

Scanning Approach

The recommended scanning method is to start with a molar, since it has greater details for easier identification. Change the scanning angle to less than 60 degrees during scanning to allow the surfaces to overlap, if the overlap is too small, the alignment may be lost.

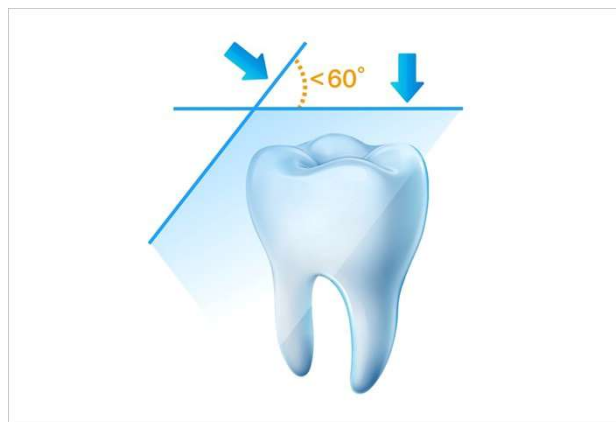

Scanning Protocol

The recommended scanning protocol consisting of 3 sweeps: occlusal, lingual and buccal to ensure good data coverage of all surfaces.

It is recommended to start the first sweep from the occlusal surface, you should start with the first molar.

The second sweep can scan both the lingual and buccal sides, and the third scan covers the opposite side of the second sweep.

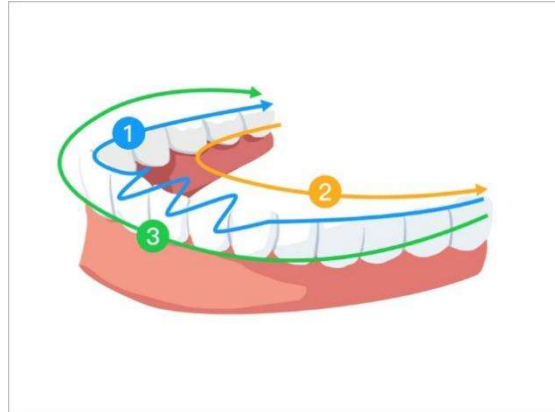

6 Acquiring a 3D Model Using the Common Scan Workflow

The common scan workflow (default workflow) allows you to scan either a partial or full arch. For either type of scan, you should scan upper jaw, lower jaw, and buccal bite registration. Once this basic information has been scanned, other scan types (such as scan body scanning) can be used to acquire other information.

For example, use a general scanning workflow to scan a 3D model for orthodontics. Scan the complete dental arch to create a 3D model. The user should scan the upper jaw, lower jaw, and buccal bite registration, as well as images of a few millimeters of gum tissue in the lingual and buccal scans. The software will combine these images to create a 3D model, which can then be uploaded to DataHub or saved locally.



In some cases, you can acquire 3D models of a single arch (partial or full) and not obtain a buccal bite registration (for example, if there are no teeth in the opposing arch), but it is recommended that you acquire both arches and a buccal bite registration when possible.

To acquire a 3D model, follow these steps:

1. Scanning the upper and lower jaw.
2. Scan the buccal bite registration.
3. Refine and check the 3D model.
4. Complete and save the 3D model.

Scanning the Upper and Lower Jaw

To scan a 3D model of the upper and lower jaw, follow these steps:

1. Dry the teeth thoroughly before starting an acquisition.
2. On the ScanPro interface, select the **Upper Jaw**  acquisition mode

OR

Press the mode button on the scanner to select the upper jaw scan mode .

3. Place the tip of the scanner on the surface of the tooth to stabilize the scanner and press the Start

Scan button. Wait until a 3D model appears on the 3D model display screen, and then slowly move it along the arch at 0-5mm from the teeth. The image will be automatically scanned and displayed on the 3D model display area.

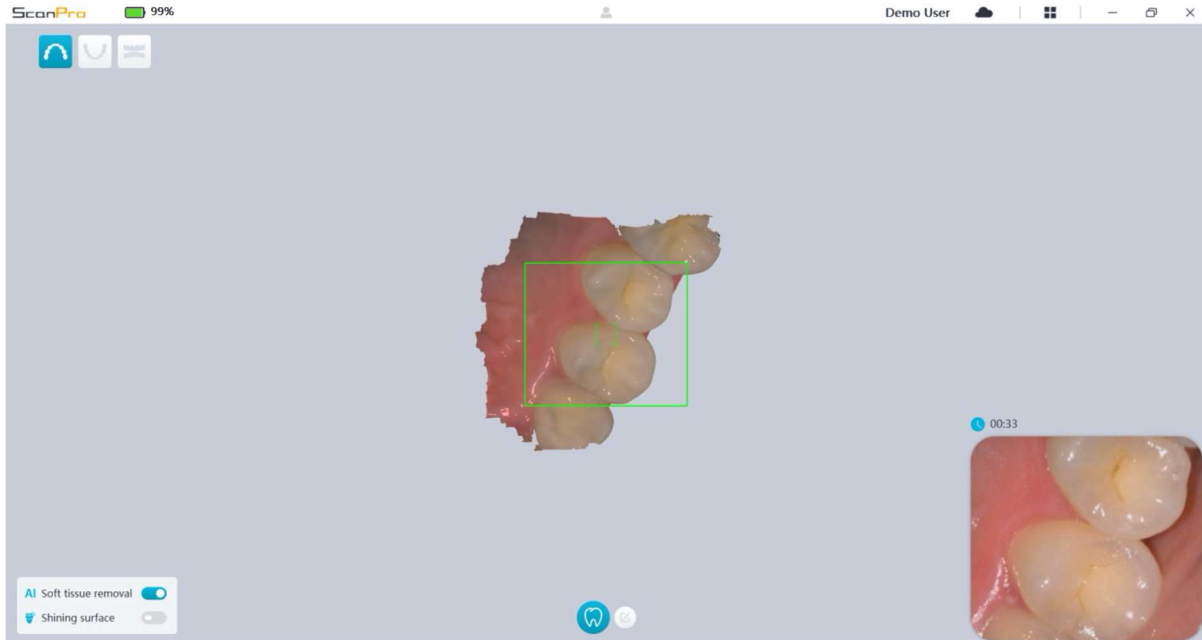

4. Slowly move the tip of the scanner along the occlusal surface to scan the remaining teeth in the arch.

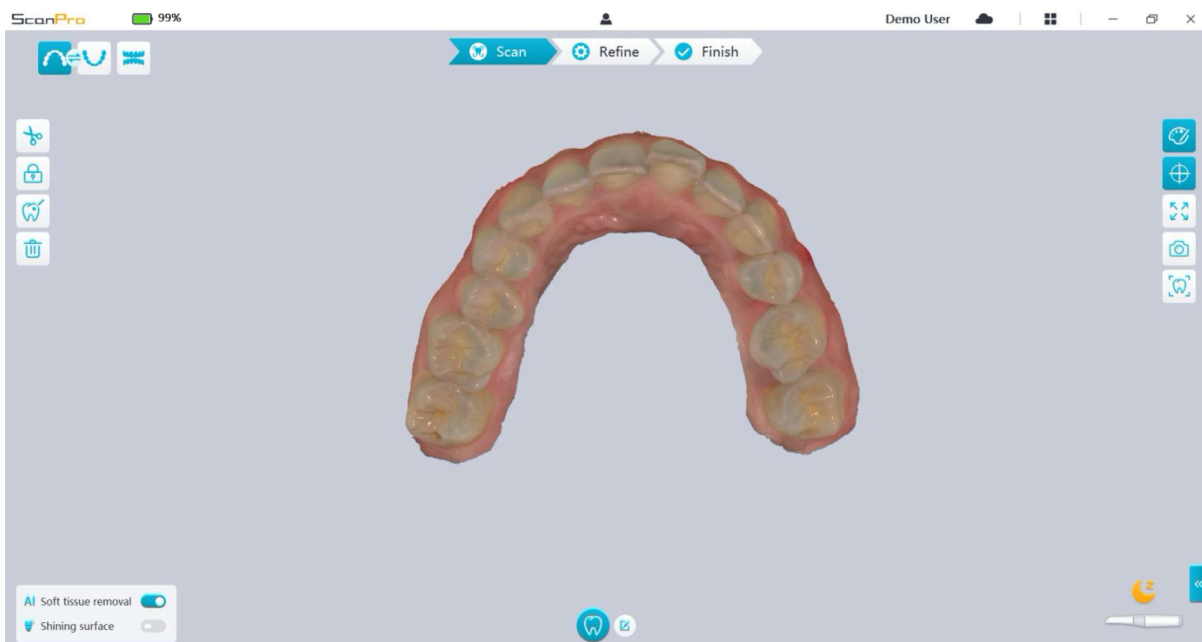



The holes on the 3D model will be displayed in the color specified by the user. It is recommended to scan these areas until the holes disappear.



5. When the occlusal surface scan is complete, scan the lingual or buccal surface of the teeth in the arch.
6. When the lingual or buccal scan is completed, scan the opposite side of the arch.



Re-dry the teeth as appropriate throughout the acquisition process.

If you need to remove soft-tissue artifacts, mismatches, or unwanted views during the acquisition, click the **Cut**  tool, then draw a curve that covers the region to be removed on the 3D model. If necessary, rescan the area to fill the holes.



You can click and hold the middle mouse button to rotate the 3D model when using tools such as Cut  , Lock  and Mark tooth



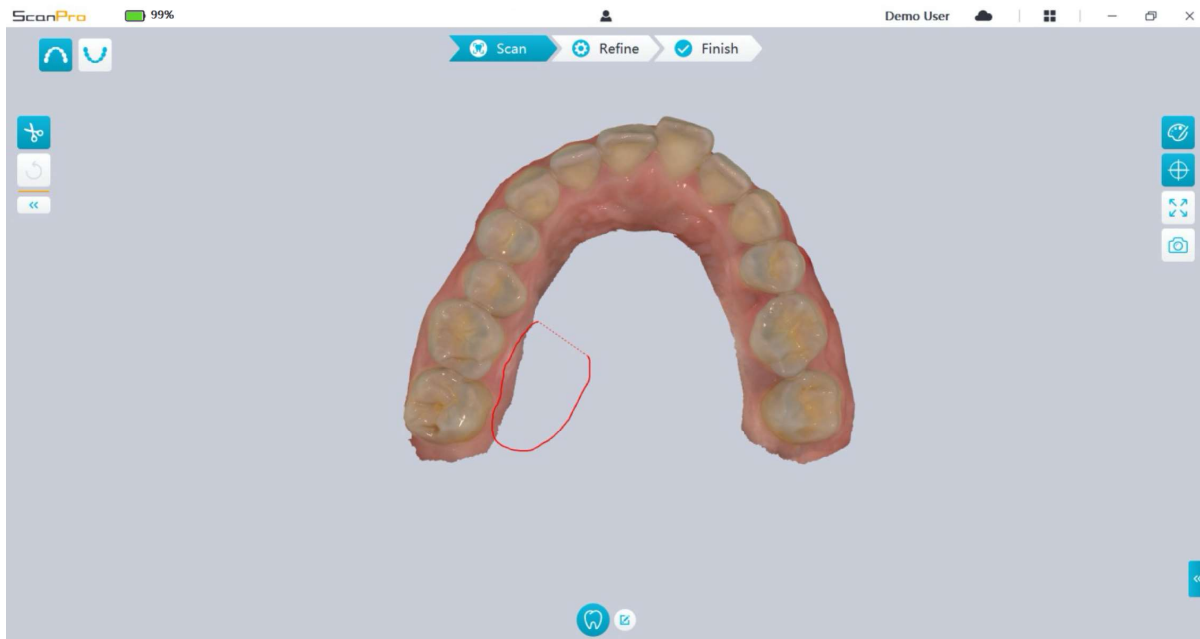

7. After scanning the upper jaw, you can continue scanning the lower jaw. On the ScanPro interface, select the **Lower Jaw**  acquisition mode

OR

Press the mode button on the scanner to select the lower jaw scan mode .

8. Repeat steps 3 to 6 until the lower jaw scan is completed.

9. Check whether there are obvious holes on the 3D model and rescan if necessary.

10. When you confirm that the 3D model of the upper and lower jaw is complete, continue with the buccal bite registration acquisition.

Scanning the Buccal Bite Registration

To acquire a buccal bite registration, follow these steps:

1. On the ScanPro interface, select the **Buccal Bite Registration**  acquisition mode

OR

Press the mode button on the scanner to select the buccal bite registration mode .

- Place the tip of the scanner into the buccal side in the patient's mouth, then rotate the tip to align with the teeth, close the patient's mouth and confirm that the bite position is correct.
- Press the Start Scan button, slowly move the scanner tip in mesial direction with equal coverage of upper and lower teeth.

The example below shows a buccal bite registration. You can use the toolbar on the left side to switch between the scanned occlusion views, or delete the scanned occlusion views for rescanning.



You can scan one or two buccal bite registrations. It is recommended to scan one on the left side and one on the right side of the patient's mouth.

- After scanning the buccal bite registrations, rotate the model and zoom the view to ensure that the bite is accurate and that there are no areas where the bite is mismatched. If necessary, you can delete the scanned occlusion and rescan.







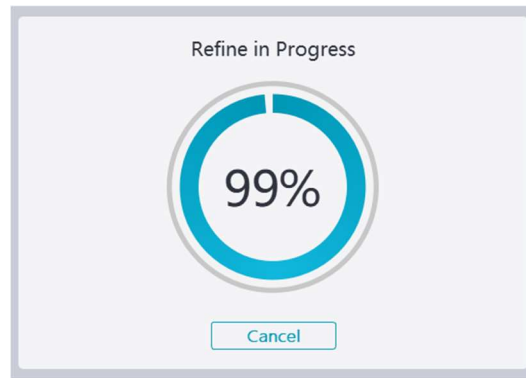





Refining and Checking the 3D Model

Refining the 3D model allows you to obtain higher accuracy data for further processing. To refine the 3D model, follow these steps:

- Click the **Refine**  button, the refining progress bar will be displayed. Depending on your computer configuration, the refining process may take several minutes.



2. After the refining is complete, manipulate the refined 3D model using the following methods:

- Click and hold on the 3D model to rotate it.
- Right-click and hold on the 3D model to move it in the window.
- Use the wheel of the mouse to zoom in or zoom out on the 3D model.
- Click the **True color**  button to view the color or monochrome 3D model.
- Click the **Zoom fit**  button to scale the model to its best view.
- Click the **View orientation**  button to see six views of the 3D model.
- Click the **Snapshot**  button to take a snapshot of the 3D model.
- Click **Upper Jaw**  button or **Lower Jaw**  button to hide or display the jaws.
- Click the **Transparency**  button to display the transparency slider, click and drag the slider to adjust the transparency of the 3D model.
- Click **Cut**  button to select and delete unwanted data.
- Click **Intraoral Camera**  button to pick up intraoral images from the scanned data.
- Click the **Quadrant Snapshot**  button to open the Quadrant Snapshot window, which displays multiple views of the model.
- Click the **Occlusion analysis**  button to analyze the occlusion space.
- Click the **Measurement**  button to measure the distance between two points on a clipping plane.

3. If you find obvious holes when checking the 3D model, click the **Scan**  button and rescan the areas to fill the holes.

4. Repeat steps 1 through 3 until you are satisfied with the 3D model.

Completing and Saving the 3D Model

To complete the scan and save the 3D model, follow these steps:

1. Click the **Finish**  button and the following page will be displayed. If you entered patient information in the previous step, it will be displayed on this page.

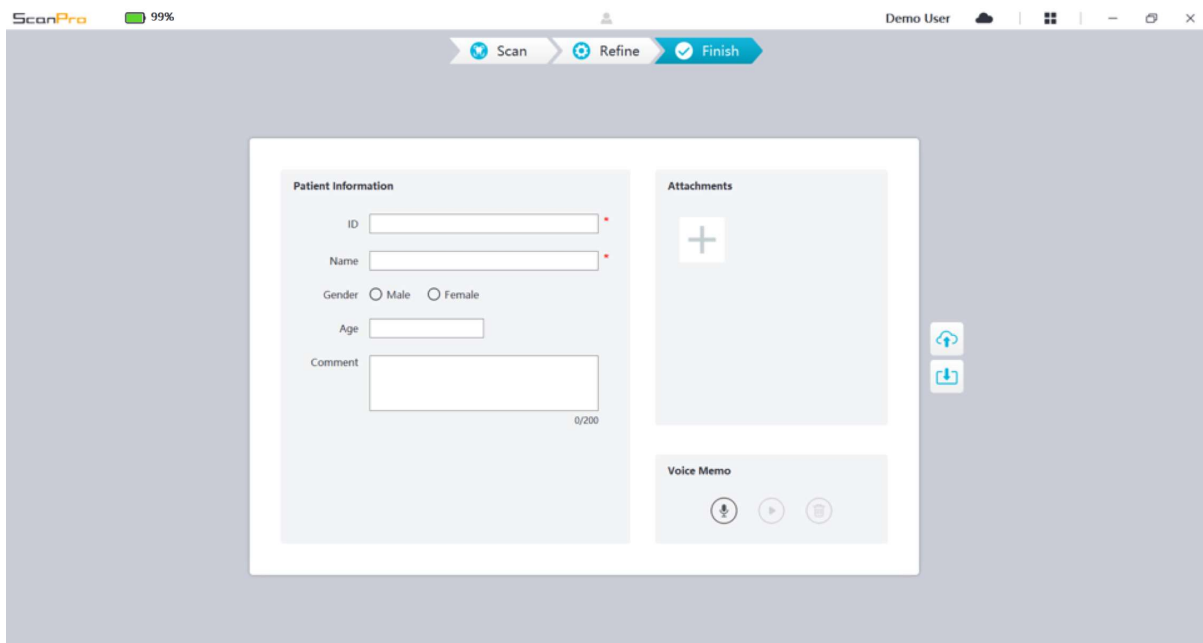

2. Complete the patient information, if necessary, you can add some attachments to the case.

3. Click the **Save to file system**  button to save the case and 3D model data to the specified local directory.

7

Acquiring a 3D Model Using the Scan Body Workflow

You can use the scanner to scan all or part of the dental arch containing the abutment or implant and create a 3D model. When using an existing abutment to scan all or part of the dental arch, use the "common scan" workflow. When you scan all or part of the dental arch that contains the implant, the scan body workflow is used. When using the scan body workflow, the software will copy the 3D model and automatically cut out the implant areas, rescan the tooth jaw with the scan body and create two 3D models: one contains the scan body and the other does not contain the scan body. The user can send these models to the dental laboratory.



In some cases, you can acquire 3D models of a single arch (partial or full) and not obtain a buccal bite registration (for example, if there are no teeth in the opposing arch), but it is recommended that you acquire both arches and a buccal bite registration when possible.

To acquire a 3D model for an implant, follow these steps:

1. Scan the upper and lower jaw.
2. Scan the buccal bite registration.
3. Mark the implant areas.
4. Install and scan the scan body.
5. Refine and check the 3D model.
6. Complete and save the 3D model.

Scanning the Upper and Lower Jaw

To scan a 3D model of the upper and lower jaw, follow these steps:

1. Dry the teeth thoroughly before starting an acquisition.
2. On the ScanPro interface, select the **Upper Jaw**  acquisition mode

OR

Press the mode button on the scanner to select the upper jaw scan mode .

3. Place the tip of the scanner on the surface of the tooth to stabilize the scanner and press the Start Scan button. Wait until a 3D model appears on the 3D model display screen, and then slowly move it along the arch at 0-5mm from the teeth. The image will be automatically scanned and displayed on the 3D model display area.



4. Slowly move the tip of the scanner along the occlusal surface to scan the remaining teeth in the arch.

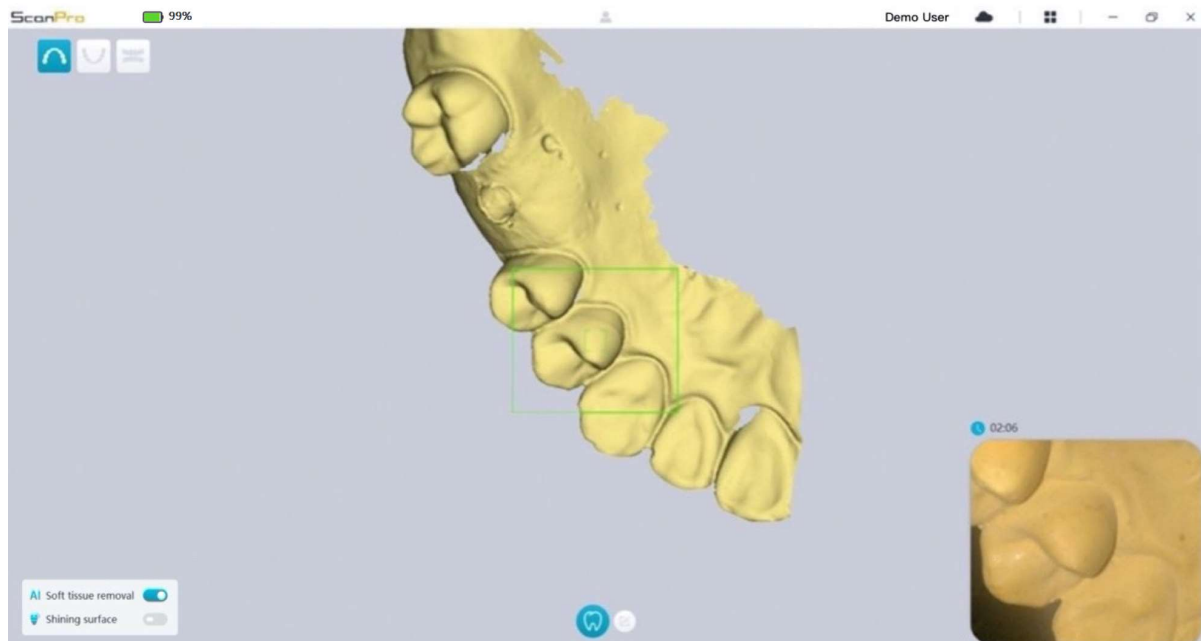



The holes on the 3D model will be displayed in the color specified by the user. It is recommended to scan these areas until the holes disappear.

- When the occlusal surface scan is complete, scan the lingual or buccal surface of the teeth in the arch.
- When the lingual or buccal scan is completed, scan the opposite side of the arch.



Re-dry the teeth as appropriate throughout the acquisition process.

If you need to remove soft-tissue artifacts, mismatches, or unwanted views during the acquisition, click the **Cut**  tool, then draw a curve that covers the region to be removed on the 3D model. If necessary, rescan the area to fill the holes.

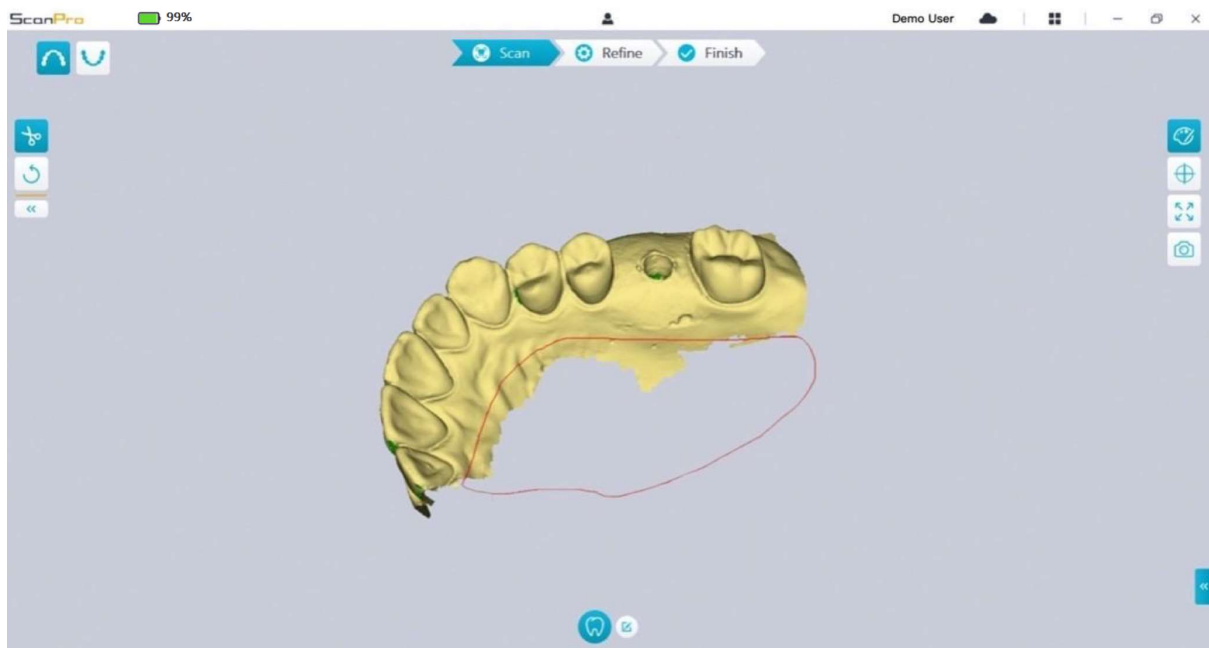

- After scanning the upper jaw, you can continue scanning the lower jaw. On the ScanPro interface, select the **Lower Jaw**  acquisition mode
OR

Press the mode button on the scanner to select the lower jaw scan mode



8. Repeat steps 3 to 6 until the lower jaw scan is completed.
9. Check whether there are obvious holes on the 3D model and rescan if necessary.
10. When you confirm that the 3D model of the upper and lower jaw is complete, continue with the buccal bite registration acquisition.

Scanning the Buccal Bite Registration

To acquire a buccal bite registration, follow these steps:

1. On the ScanPro interface, select the **Buccal Bite Registration** acquisition mode



OR

Press the mode button on the scanner to select the buccal bite registration mode



2. Place the tip of the scanner into the buccal side in the patient's mouth, then rotate the tip to align with the teeth, close the patient's mouth and confirm that the bite position is correct.
3. Press the Start Scan button, slowly move the scanner tip in mesial direction with equal coverage of upper and lower teeth.

The example below shows a buccal bite registration. You can use the toolbar on the left side to switch between the scanned occlusion views, or delete the scanned occlusion views for rescanning.

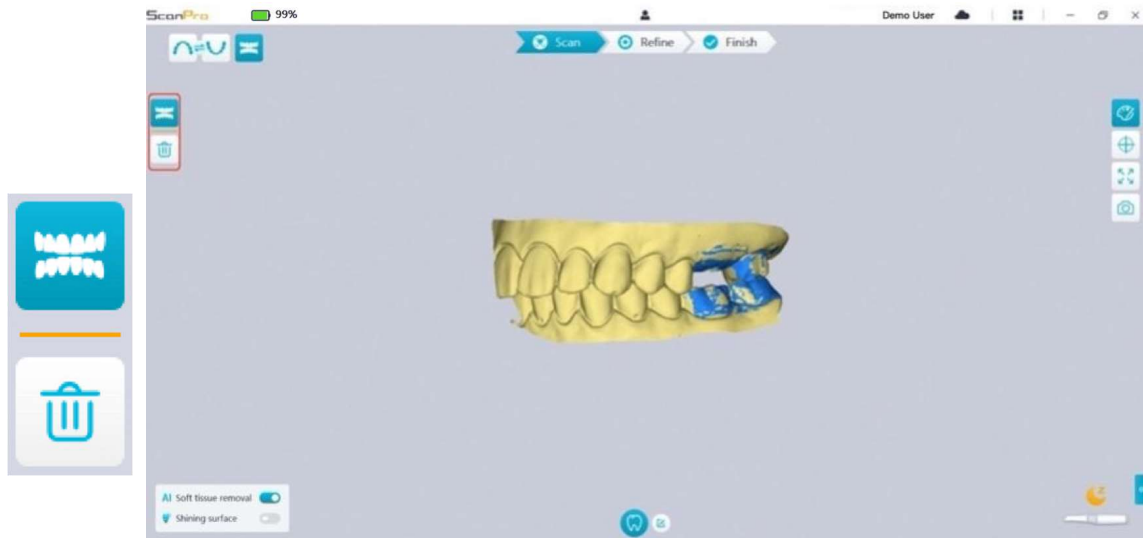



You can scan one or two buccal bite registrations. It is recommended to scan one on the left side and one on the right side of the patient's mouth.

4. After scanning the buccal bite registrations, rotate the model and zoom the view to ensure that the bite is accurate and that there are no areas where the bite is mismatched. If necessary, you can delete the scanned occlusion and rescan.



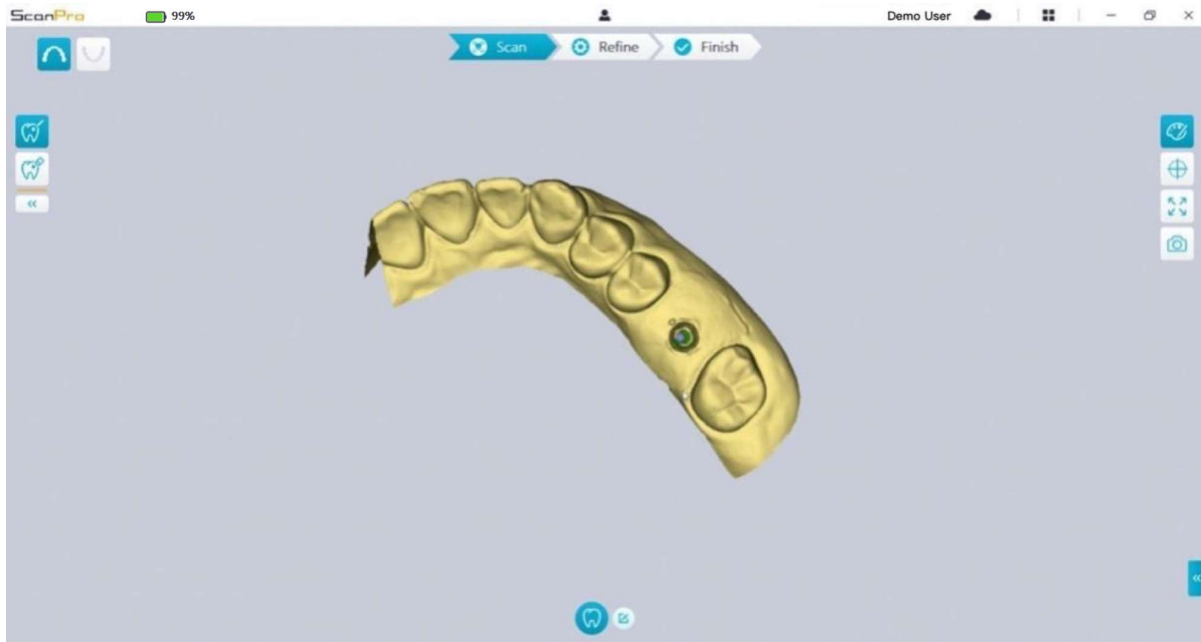

Marking the Implant Areas

After the scan is complete, you can mark the implant areas so that you can rescan the area after installing the scan body. To mark one or more implant areas, follow these steps:

1. On the ScanPro interface, select the jaw ( or ) with implant to activate the 3D model.
2. Click the **Mark tooth**  button, and then click in the center of the implant. A 3D ball will display on the occlusal surface indicating an implant.



3. Rotate the 3D model if necessary, and mark all the implant areas.

 You can click and hold the middle mouse button to rotate the 3D model when using tools such as Cut  , Lock  and Mark tooth  .

4. Click the **Return**  button to quit Mark tooth tool.

Installing and Scanning the Scan Body

After installing the scan body, follow the steps below to scan the scan body:

1. After making the implant areas, click the **Config Scan** button at the bottom of the ScanPro interface.

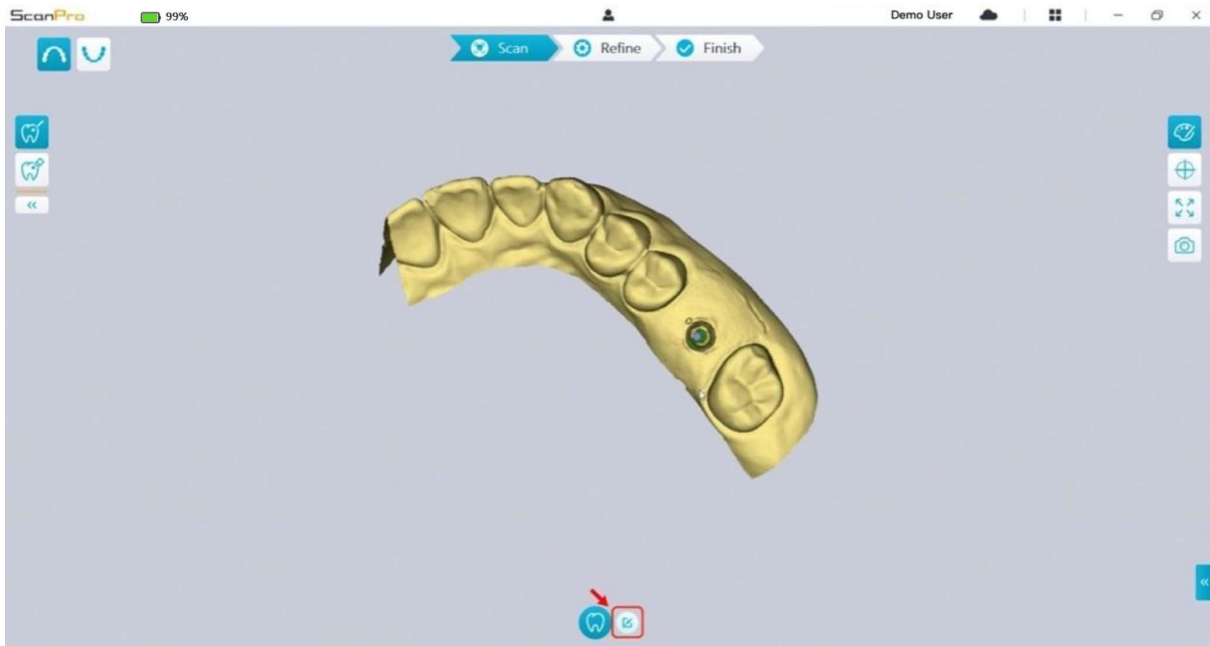

2. Click the **Add scan body** button in the pop-up window.



3. Click the **Scan Body** button below.



4. Check whether the part that the software automatically cut out from the implant areas is sufficient to contain the diameter of the scan body. If the cut out part is not enough to contain the scan body, you can click the **Cut**  button, and cut off the necessary part to cover the scan body. In order to avoid the situation that the cut out part is not sufficient to contain the scan body, you can adjust the "Implant cut out diameter" option to fit the scan body you choose. After the adjustment, the change will take effect the next time you open the software.

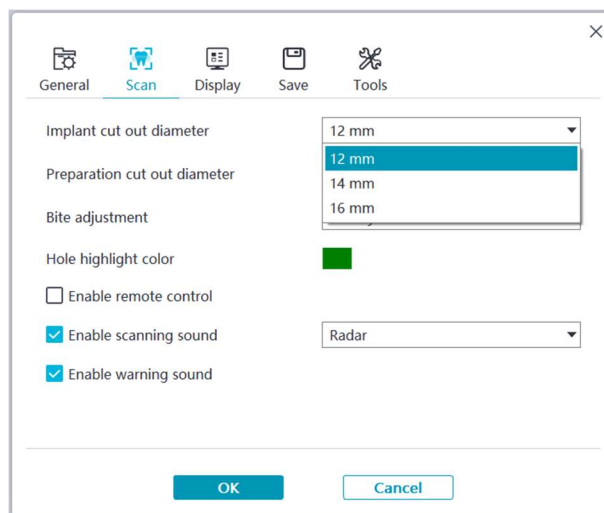

5. Start the scanner and scan the part of the scan body areas that has been cut out.

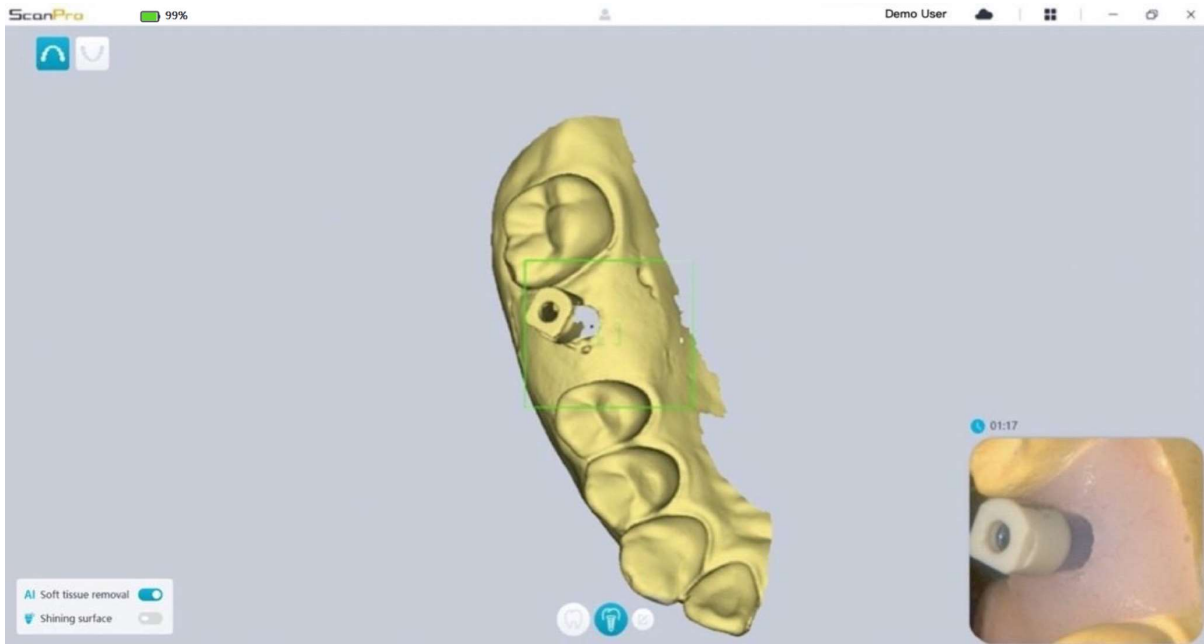

Start the scan body scanning from the surface 1-2 teeth away from the scan body, so that the system can recognize the 3D structure.

6. When you have completed the scan body scanning, proceed to the **Refining and Checking the 3D Model** step.







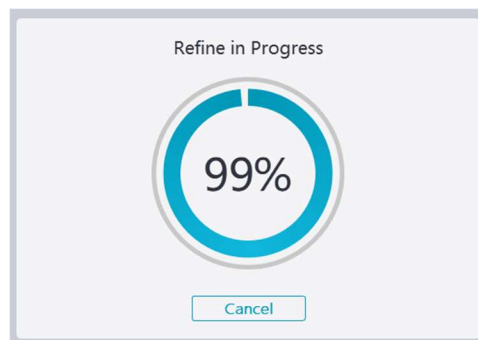







Refining and Checking the 3D Model

Refining the 3D model allows you to obtain higher accuracy data for further processing. To refine the 3D model, follow these steps:

1. Click the **Refine**  button, the refining progress bar will be displayed. Depending on your computer configuration, the refining process may take several minutes.



2. After the refining is complete, manipulate the refined 3D model using the following methods:

- Click the **Common scan**  button to view the 3D model without scan body.
- Click the **Scan body**  button to view the 3D model with scan body.
- Click and hold on the 3D model to rotate it.
- Right-click and hold on the 3D model to move it in the window.
- Use the wheel of the mouse to zoom in or zoom out on the 3D model.
- Click the **True color**  button to view the color or monochrome 3D model.
- Click the **Zoom fit**  button to scale the model to its best view.
- Click the **View orientation**  button to see six views of the 3D model.
- Click the **Snapshot**  button to take a snapshot of the 3D model.
- Click **Upper Jaw**  button or **Lower Jaw**  button to hide or display the jaws.
- Click the **Transparency**  button to display the transparency slider, click and drag the slider to adjust the transparency of the 3D model.
- Click **Cut**  button to select and delete unwanted data.
- Click **Intraoral Camera**  button to pick up intraoral images from the scanned data.
- Click the **Quadrant Snapshot**  button to open the Quadrant Snapshot window, which displays multiple views of the model.
- Click the **Occlusion analysis**  button to analyze the occlusion space.
- Click the **Measurement**  button to measure the distance between two points on a clipping plane.

3. If you find obvious holes when checking the 3D model, click the **Scan**  button and rescan the areas to fill the holes.

4. Repeat steps 1 through 3 until you are satisfied with the 3D model.

Completing and Saving the 3D Model

To complete the scan and save the 3D model, follow these steps:

1. Click the **Finish**  button and the following page will be displayed. If you entered patient information in the previous step, it will be displayed on this page.

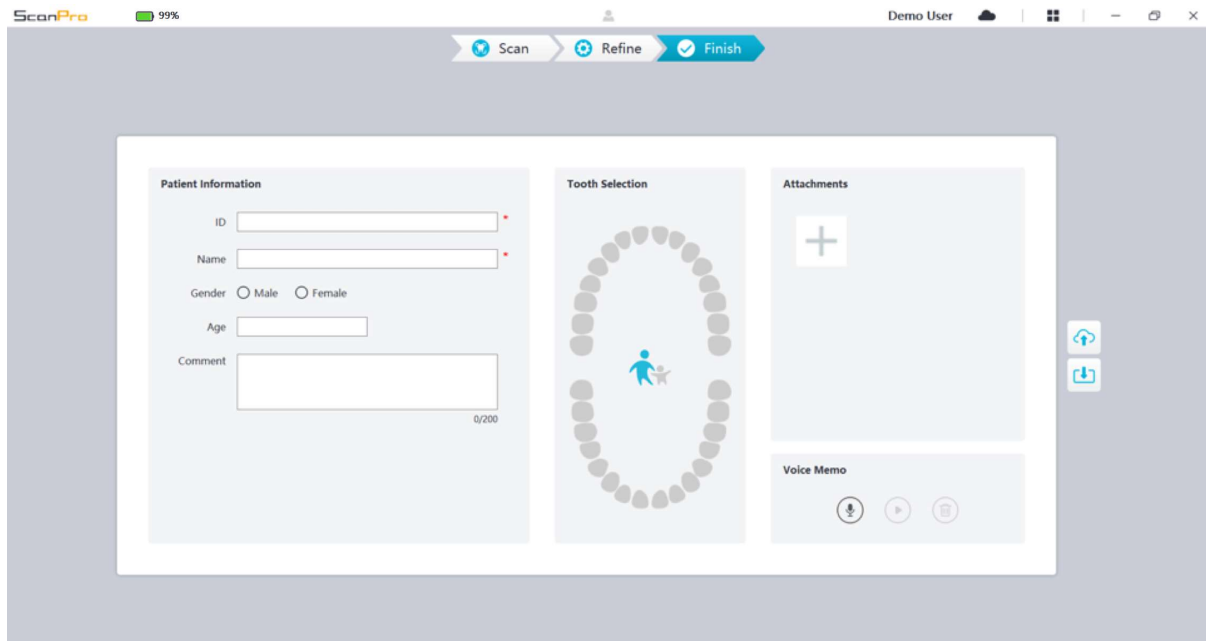

2. Complete the patient information, if necessary, you can add some attachments to the case.
3. Click the **Save to file system**  button to save the case and 3D model data to the specified local directory.

8

Acquiring a 3D Model Using the Preparation Workflow

Depending on your workflow preferences, you can use the preparation workflow. This workflow provides you with two choices:

- You can scan the tooth before preparing, and then take another scan after the tooth is prepared.
- You can import the previously saved data before preparing, and then start to scan the preparation.

With either option, two 3D models will be created after the scan is completed: one containing the unprepared tooth and the other containing the preparation. You or the lab can use these 3D models for restorations to make them closely resembles the original tooth.

The following steps describe how to combine the previous scan with the new scan of the preparation.

1. Import the scanned data before preparing
2. Scan the preparation areas
3. Refine and check the 3D model.
4. Complete and save the 3D model.

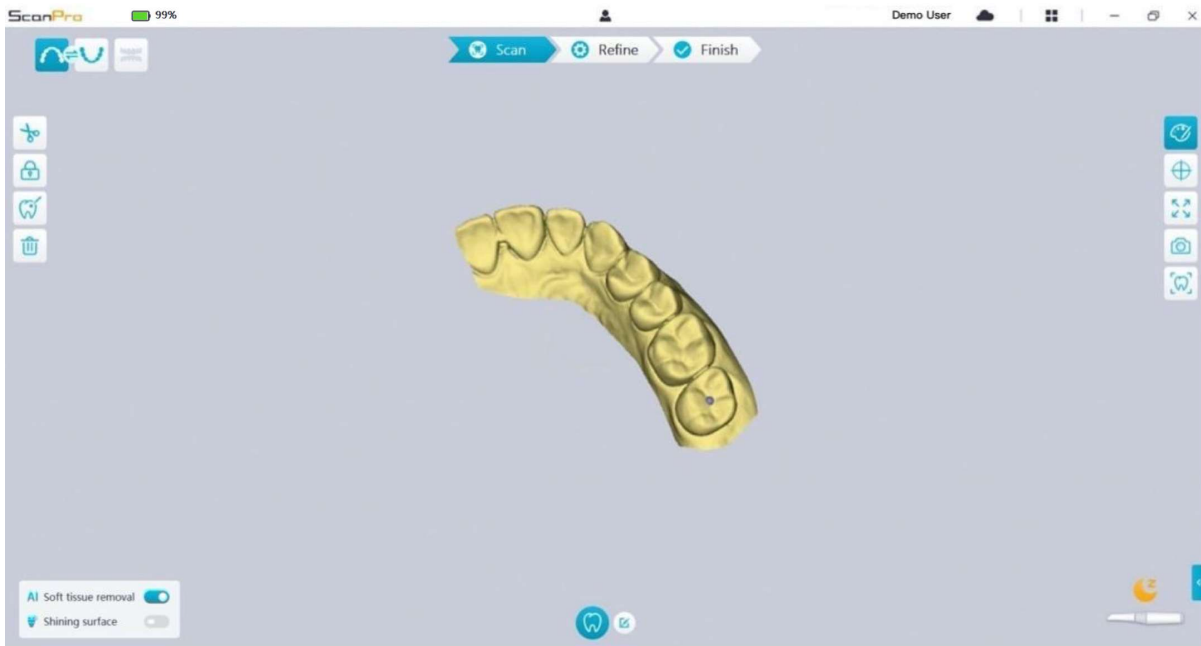

Import the scanned data before preparing

1. Click the **Option menu**  button and select Import scan data.
2. Select the .scan file you want to import, and click Open. Wait for the software to import the data, and the 3D model will be displayed after the import is complete.



3. Click the **Mark tooth**  button, and then click in the center of the occlusal surface of the preparation. A 3D ball will display on the occlusal surface indicating a preparation area.
4. Rotate the 3D model if necessary, and mark all the preparation areas.



You can click and hold the middle mouse button to rotate the 3D model when using tools such as Cut , Lock  and Mark tooth .

5. Click the **Return**  button to quit Mark tooth tool.

Scan the Preparation Areas

After marking the preparation areas, you need to rescan these areas. To scan one or more marked preparation areas, follow these steps:

1. Click the **Config Scan** button at the bottom of the ScanPro interface.



2. Click the **Add preparation** button in the pop-up window

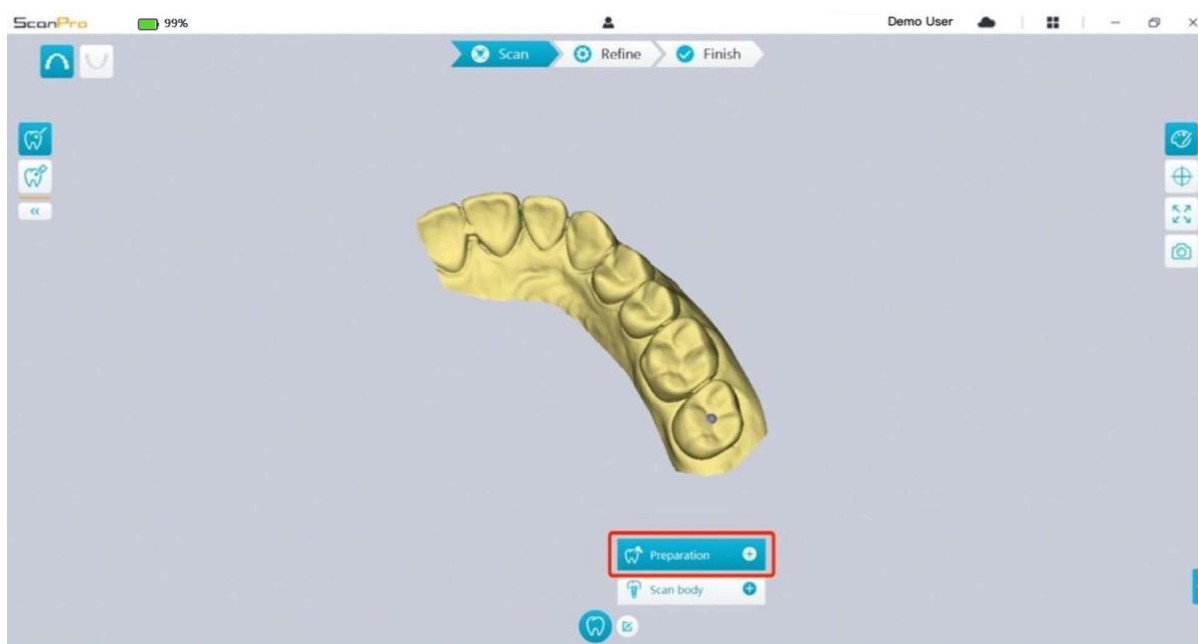

3. Click the **Preparation** button below

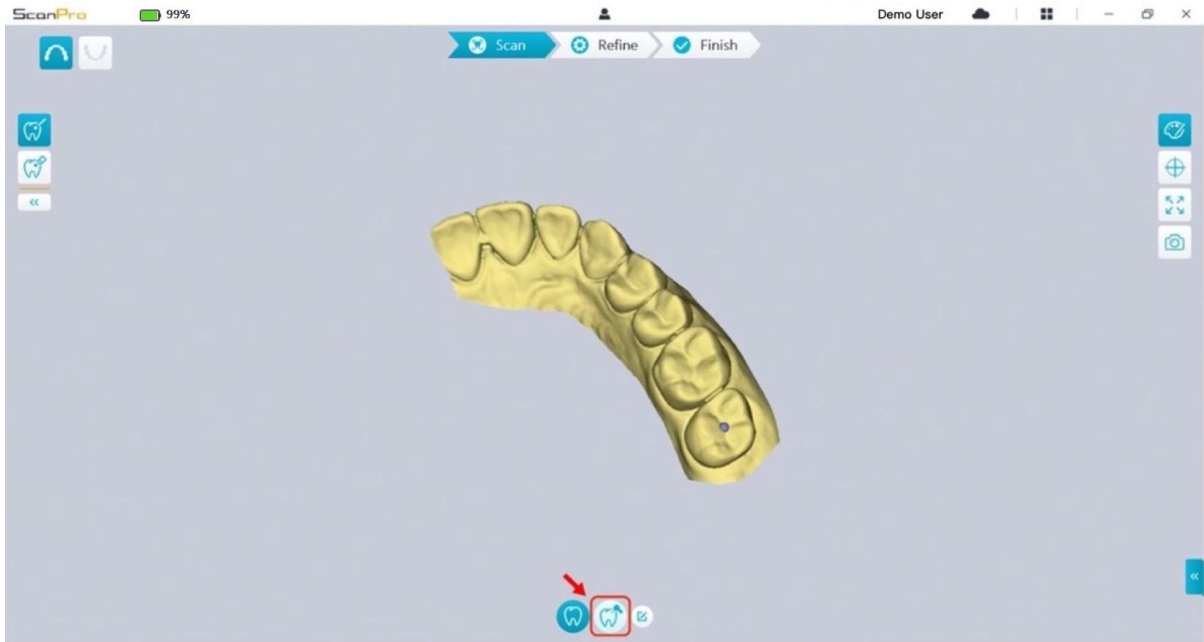

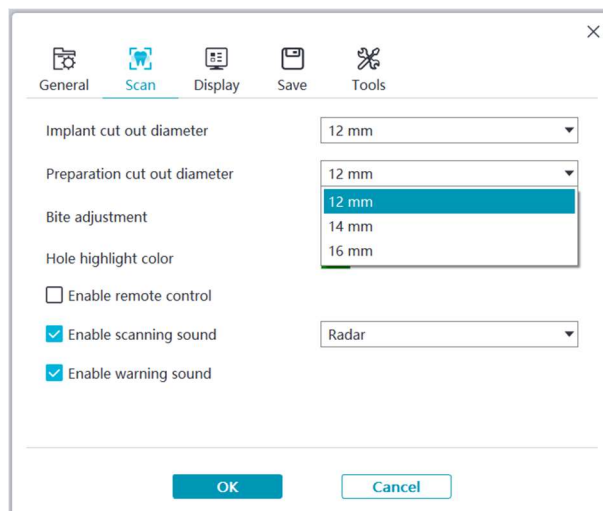

4. Check whether the part that the software automatically cut out from the preparation areas is sufficient to contain the preparation. If the cut out part is not enough to contain the preparation, you can click the  button, and cut off the necessary part to cover the preparation. In order to avoid the situation that the cut out part is not sufficient to contain the preparation, you can adjust the "Preparation cut out diameter" option to fit the preparation. After the adjustment, the change will take effect the next time you open the software.



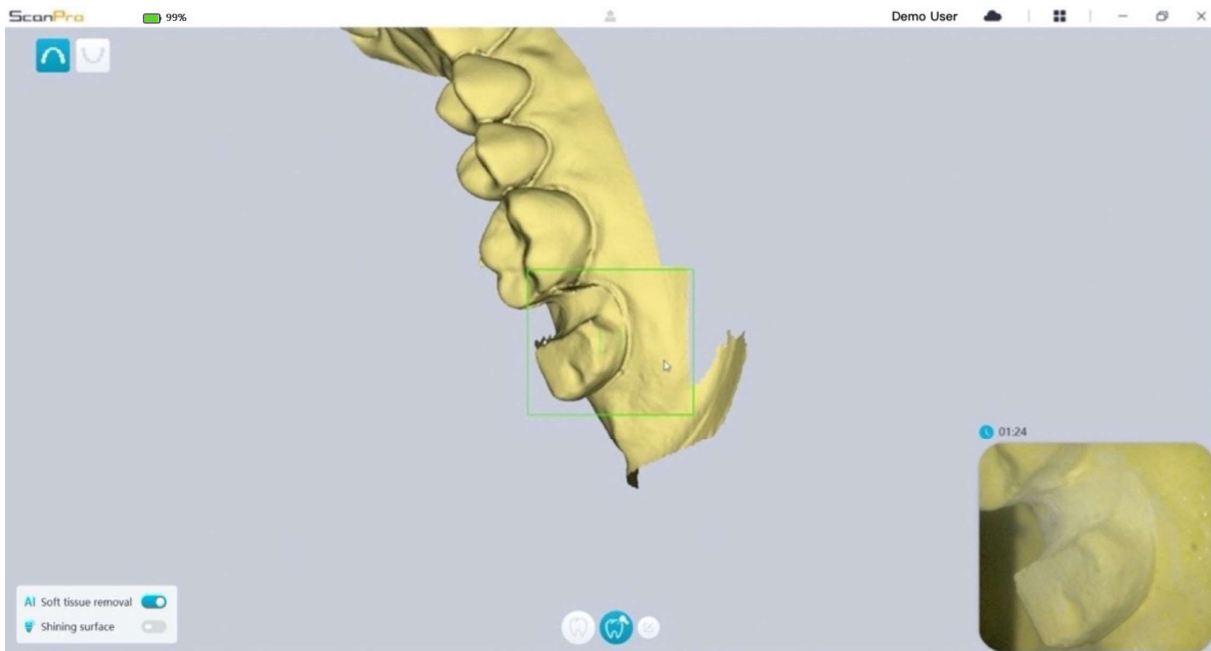

5. Start the scanner and scan the part of the preparation areas that has been cut out.



- If you need to remove soft-tissue artifacts, mismatches, or unwanted views during the acquisition, click the **Cut**  tool, then draw a curve that covers the region to be removed on the 3D model. If necessary, rescan the area to fill the holes.



You can click and hold the middle mouse button to rotate the 3D model when using tools such as Cut , Lock  and Mark tooth .

- When you have completed the preparation scanning, proceed to the **Refining and Checking the 3D Model** step.







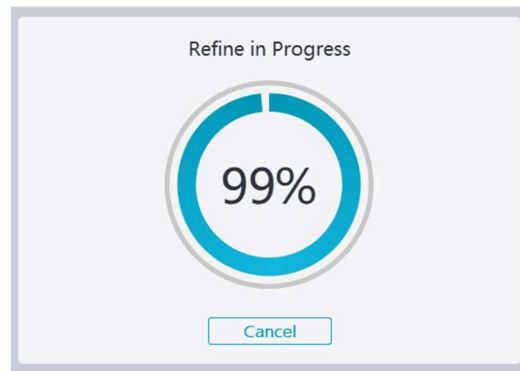







Refining and Checking the 3D Model

Refining the 3D model allows you to obtain higher accuracy data for further processing. To refine the 3D model, follow these steps:

- Click the **Refine**  button, the refining progress bar will be displayed. Depending on your computer configuration, the refining process may take several minutes.



2. After the refining is complete, manipulate the refined 3D model using the following methods:

- Click the **Common scan**  button to view the 3D model before preparing.
- Click the **Preparation**  button to view the 3D model after preparing.
- Click and hold on the 3D model to rotate it.
- Right-click and hold on the 3D model to move it in the window.
- Use the wheel of the mouse to zoom in or zoom out on the 3D model.
- Click the **True color**  button to view the color or monochrome 3D model.
- Click the **Zoom fit**  button to scale the model to its best view.
- Click the **Six Views**  button to see six views of the 3D model.
- Click the **Snapshot**  button to take a snapshot of the 3D model.
- Click **Upper Jaw**  button or **Lower Jaw**  button to hide or display the jaws.
- Click the **Transparency**  button to display the transparency slider, click and drag the slider to adjust the transparency of the 3D model.
- Click **Cut**  button to select and delete unwanted data.
- Click **Intraoral Camera**  button to pick up intraoral images from the scanned data.
- Click the **Quadrant Snapshot**  button to open the Quadrant Snapshot window, which displays multiple views of the model.
- Click the **Undercut check**  button to view the undercut areas on the surface of the preparation.
- Click the **Occlusion analysis**  button to analyze the occlusion space.
- Click the **Measurement**  button to measure the distance between two points on a clipping

plane.

3. If you find obvious holes when checking the 3D model, click the **Scan**  button and rescan the areas to fill the holes.
4. Repeat steps 1 through 3 until you are satisfied with the 3D model.

Completing and Saving the 3D Model

To complete the scan and save the 3D model, follow these steps:

1. Click the **Finish**  button and the following page will be displayed. If you entered patient information in the previous step, it will be displayed on this page.

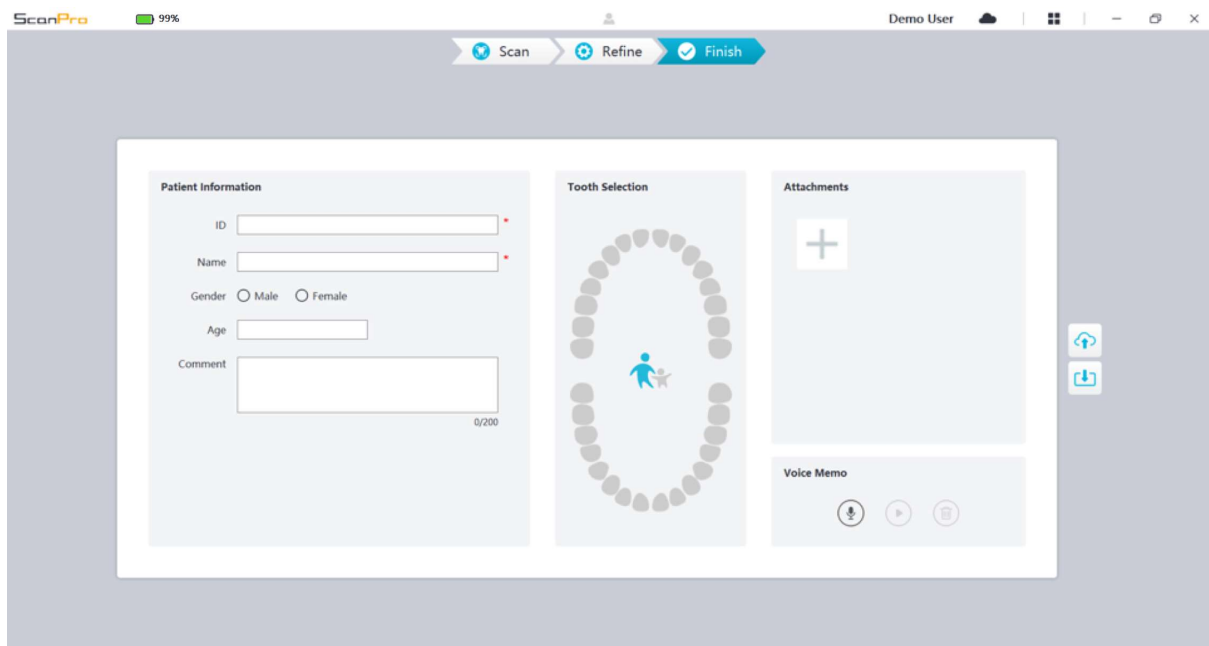

2. Complete the patient information, if necessary, you can add some attachments to the case.
3. Click the **Save to file system**  button to save the case and 3D model data to the specified local directory.

9 Maintenance

Cleaning, Disinfecting, and Sterilizing

You must clean, disinfect, and sterilize the scanner and accessories regularly.



For detailed information on cleaning, disinfection and sterilization, please refer to the “AS 200E User Manual: Safety, Regulatory and Technical Specifications”.

10 Troubleshooting

AS 200E Troubleshooting Instructions

Problem Description	Action
There is mismatching and overlap on the 3D model.	Remove mismatched data and excessive tissue using the Cut tool and rescan.
After bite registration, there is a gap or intersection between the upper jaw and the lower jaw.	Set "Bite adjustment" to "Avoid intersections" in Preferences. Delete the incorrect bite view, and rescan.
Precision degradation is observed, or images are not well-stitched during acquisition.	Ensure that the lens window at the base of the scanner is clean by wiping it with a moist, lint-free cloth or lens tissue. Use a lens tissue or lint-free cloth to remove any dust or water stains. Make sure the tip is firmly installed and there are no dark edges on the live video.
Reconstruction of metallic preparations is sometimes difficult.	Adjust the scanner position (for example: distance or angle) and scan more of the area. Move the surgical light away from the patient to decrease light scatter. Turn on "Shining Surface" button.
The tip is installed but not detected. No live video is displayed, and the Scanner tip not detected icon is displayed at the bottom-right of the interface.	Reinstall the tip, and make sure the tip is in firm contact with the scanner.
Fogging appears on the inner surface of the lens window at the base of the	Mount a completely dry tip on the scanner, and place the scanner in the holder or set it on the desk, and wait until the fogging fades. If

<p>scanner.</p>	<p>the fogging does not disappear completely after 24 hours, contact your local service provider for assistance.</p> <p>Ensure that the tip is thoroughly dry before mounting on the scanner, and do not use a cloth soaked in disinfectant to clean the scanner.</p>
<p>The scanner does not cast light, and a static preview image is displayed in the video preview screen.</p>	<p>Close the ScanPro software, and then open the ScanPro software again.</p>

