

WIFI PROJECTOR

USER MANUAL



CONTENTS

PACKING LIST	01
PRODUCT INTRODUCTION	02
NORMAL CONNECTION	03
SIGNAL SOURCE	04
IOS WIFI DISPLAY	05-08
ANDROID WIFI DISPLAY	09-10
DLAN CONNECTION	11
OTHER CONNECTION METHOD	12
BASIC OPERATION	13
BASIC SETTINGS	14-16
QUICK GUIDE TO CLEAN THE DIRT SPOT ON THE SCREEN	17

PACKING LIST

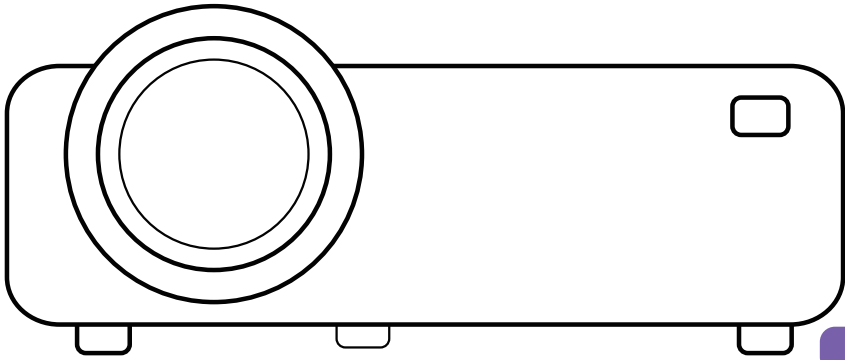

Projector

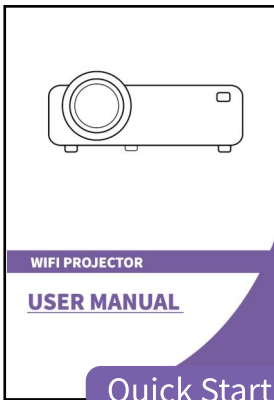

Quick Start Guide

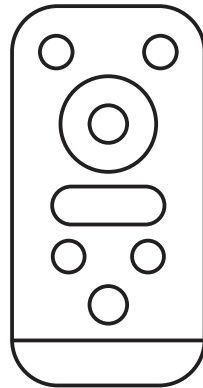

Remote

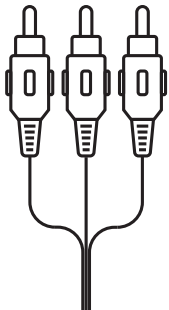

AV Cable

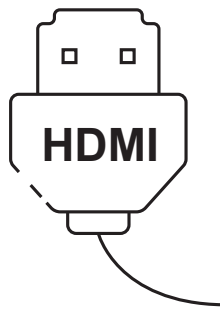

HDMI Cable

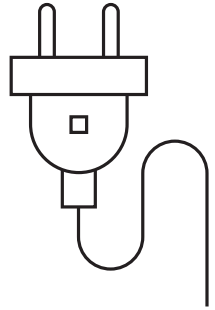

Power Cable

PRODUCT INTRODUCTION

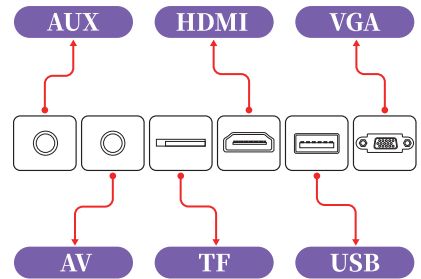
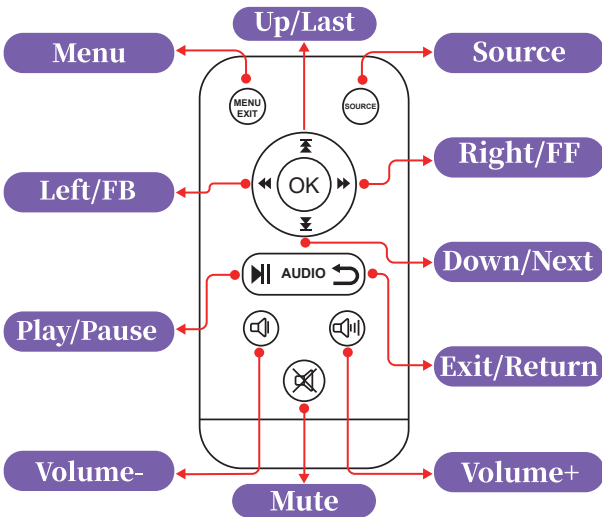
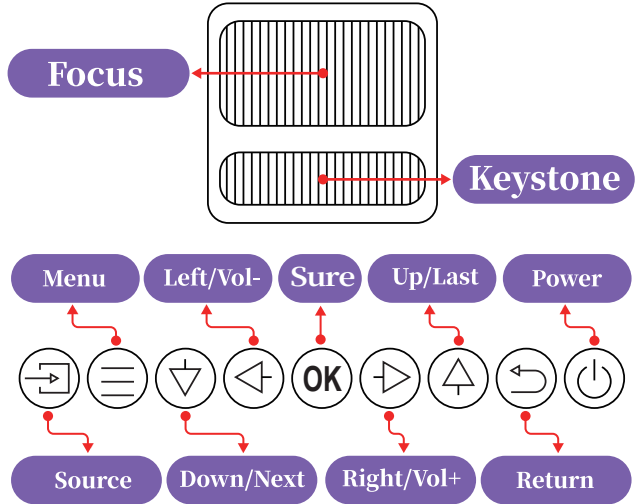
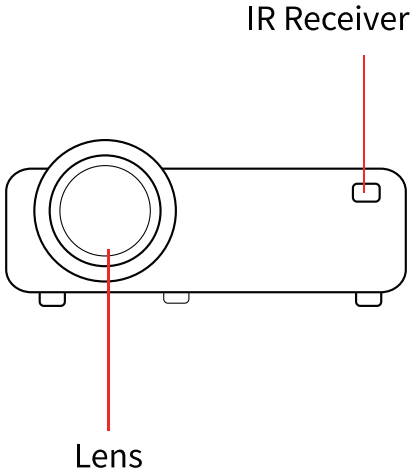

NORMAL CONNECTION

01

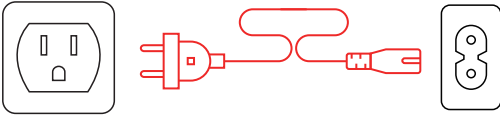

Connect the power cable into the projector

02

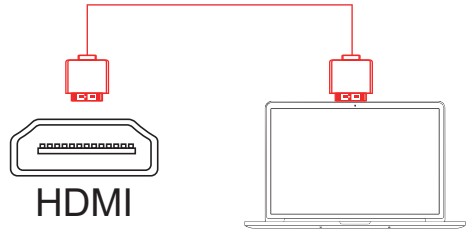

Connect your device to the projector

03

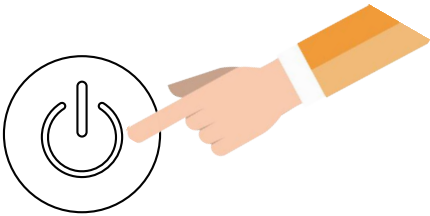

Press the power button to turn on

04

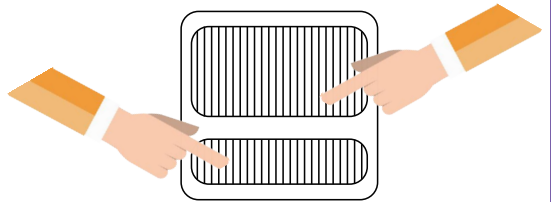

Adjust keystone and focus to get the best picture quality

04

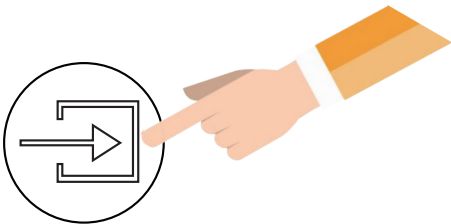

Press Left/Right button to project your input device

06

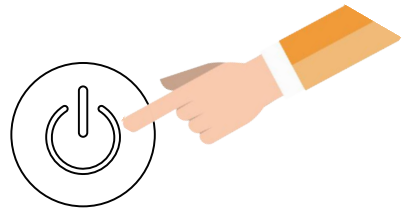

Turn off the projector after use

SIGNAL SOURCE

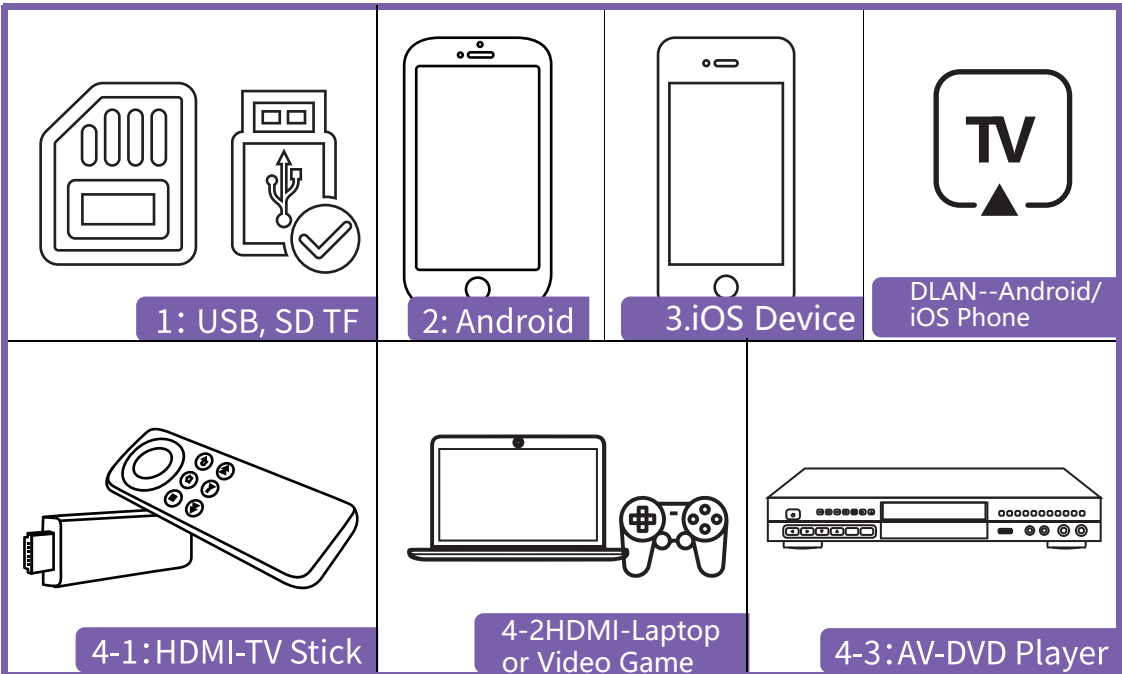
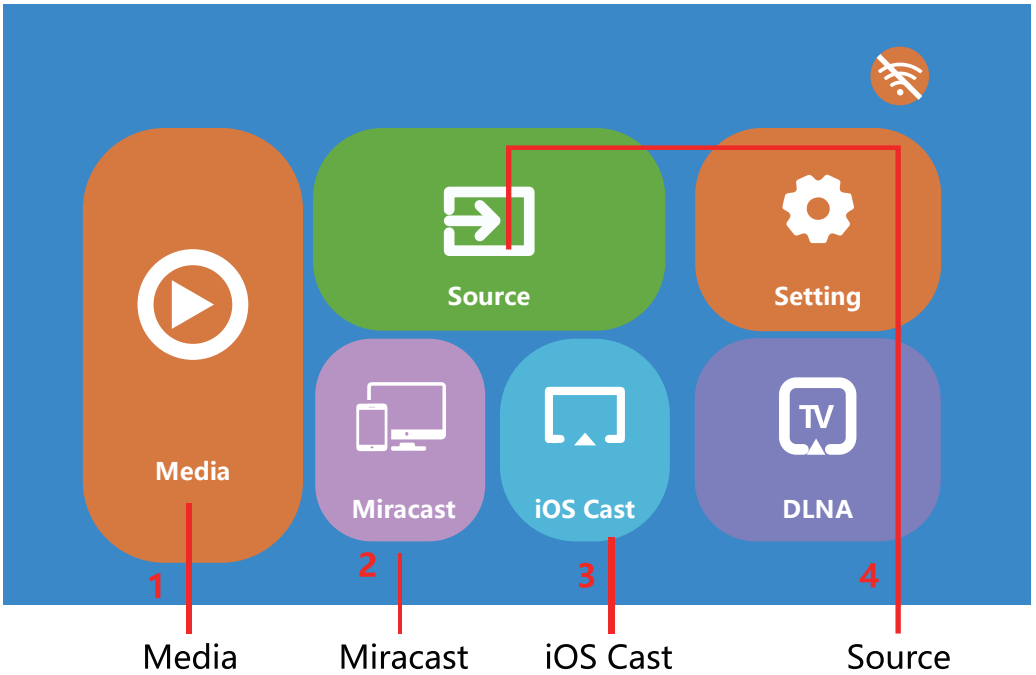

IOS WIFI DISPLAY

To connect your IOS devices with the projector, you just need to finish three steps: Connect the projector to your home wifi, Connect your IOS devices to your home wifi, Open screen mirroring function of your IOS devices.

Step 1: Connect the projector to your home WiFi

(1) Turn on the projector and Choose **[Settings]**.

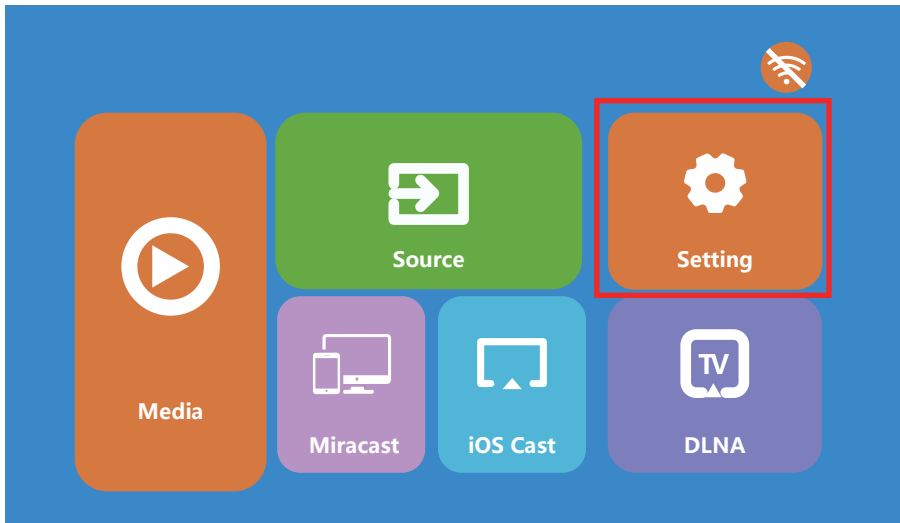

(2) Click **[Network Information]** and **[Scan]** to connect your home WiFi.

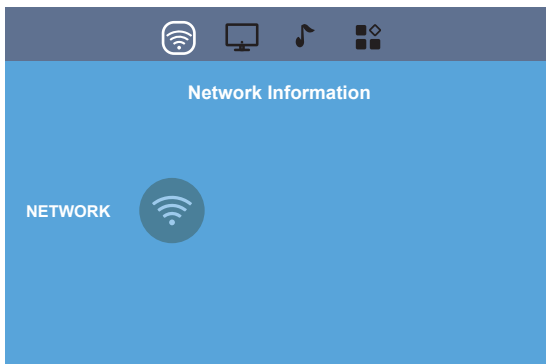

Network Information	
SSID	
Status	Enable
IP Address	0, 0, 0, 0,
MAC Address	06-54-88-CC-58-E1
<input type="button" value="Scan"/>	

Click your Home WiFi Name then press OK button to put in Password.

Access Point	
Home WiFi Name	NONE
ChinaNet-sg6f	NONE
ChinaNet-ZJH3	NONE
ChinaNet-TF	NONE
ChinaNet-WGS	NONE
ChinaNet-HKN	NONE
ChinaNet-MJK	NONE

Connected To...

SSID Home WiFi Name
 Mode Node
 Password

Connected To...

SSID Home WiFi Name
 Mode Node
 Password

Connected To...

SSID Home WiFi Name
 Mode Node
 Password

Connected To...

SSID Home WiFi Name
 Mode Node
 Password

Please wait...

Network Information

SSID	Home WiFi Name
Status	Enable
IP Address	192.168.20.18
MAC Address	08-54-BB-CC-58-E1

Step 2: Connect your ios devices to your home Wi-Fi.

Make sure the devices and projector share the same Wi-Fi.

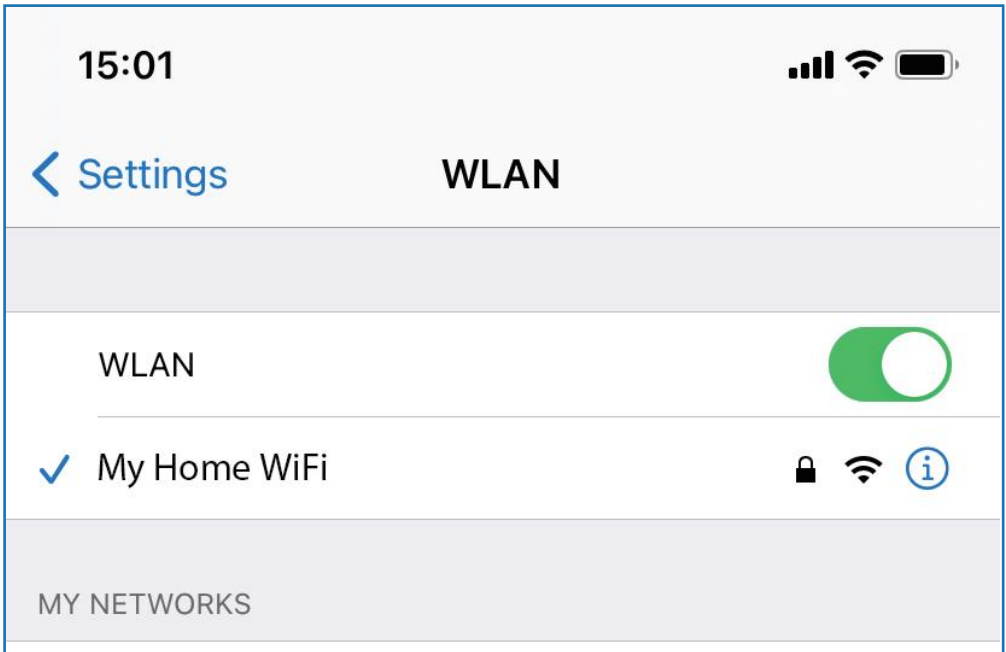

Step 3: Open screen mirroring function of your ios devices.

(1) Go back to the projector's home page, click iOS Cast.

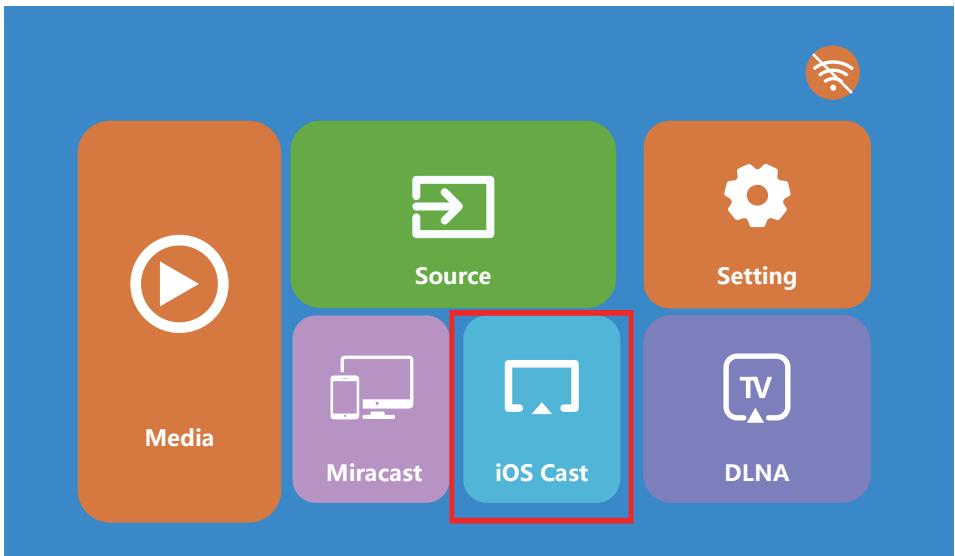

Mirror your iPhone, iPad or iPod touch

1. Please connect the projector to your home router WiFi under [SETUP] menu.
2. Make sure that your iOS device is connected to the same network that your projector is connected to.

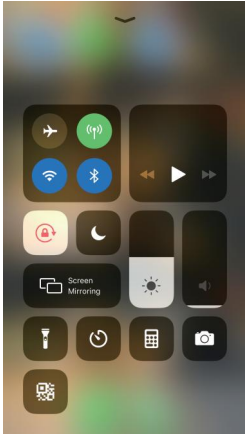

3. On your iOS device, open Control Center and tap Screen Mirroring.



4. Looking for devices that can be mirrored on.

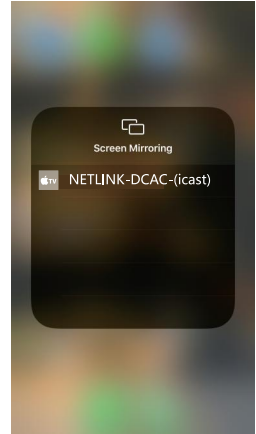

5. Select NETLINK-DCAC-(icast) from the list.

(2) Open the Screen Mirroring/AirPlay function on your IOS devices, click the projector WiFi name[such as: NETLINK-DCAC-(icast)], waiting few seconds then you will be able to achieve screen mirroring on your devices.

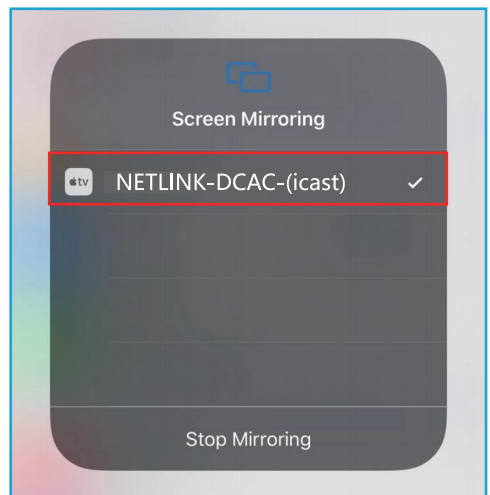
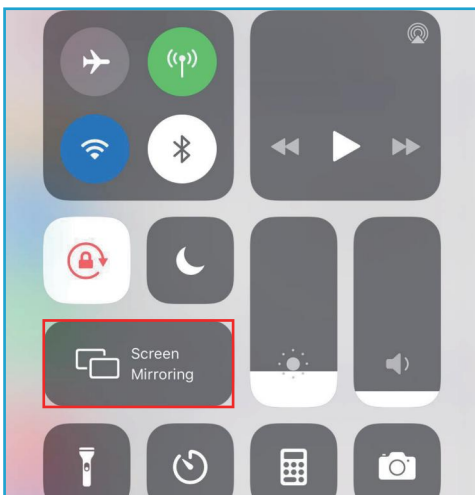

ANDROID WIFI DISPLAY

Step 1: Turn on the projector and Choose **[Miracast]**.

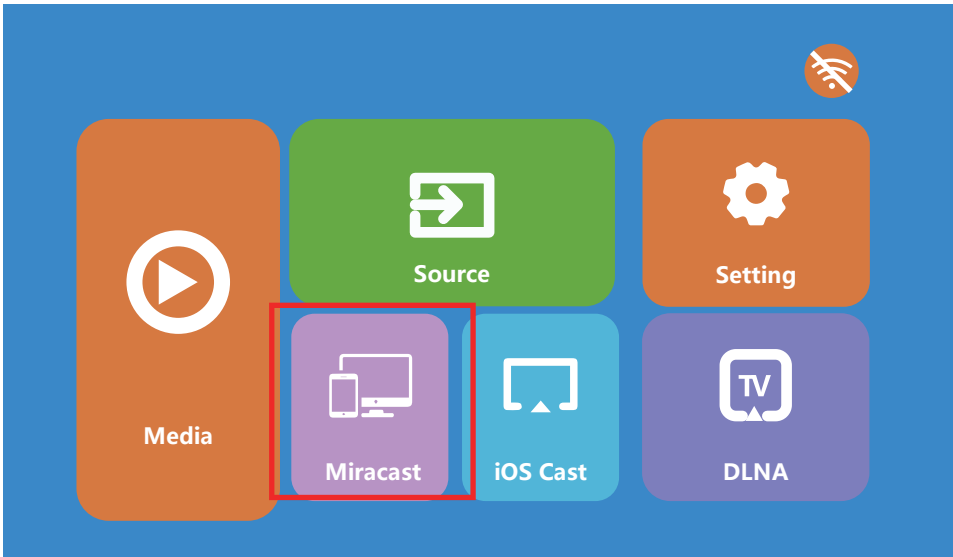

Miracast

To connect Android Mobile/Pad Device with Projector Based on WiFi-Display Technology

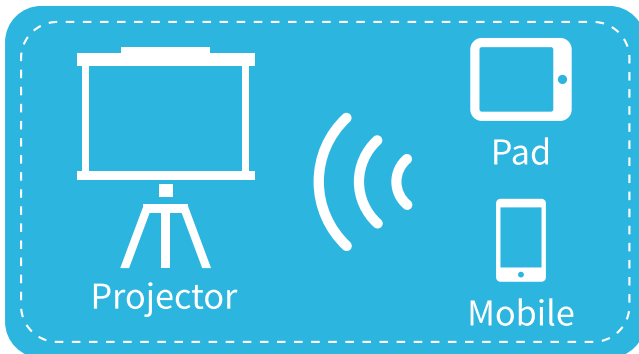

1. On your Android Mobile/Pad, open the settings menu.
2. Access your display settings or screen-mirroring.
3. Select your Miracast receiver: mcast-58e1

Step 2: Open the **Multi-Screen/Miracast/Smart View** on the Android devices and click the **WiFi name [such as: mcast-58e1]**, waiting for a few seconds, the connection will be successful.

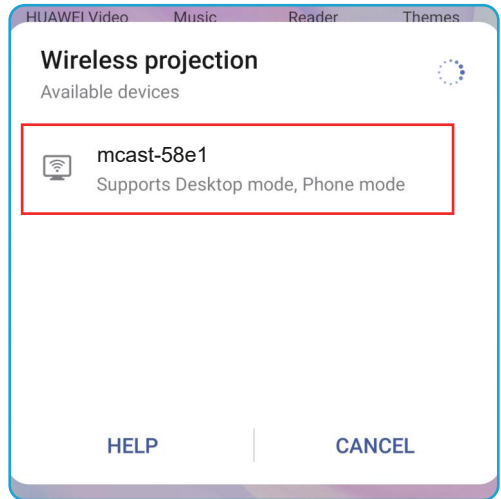
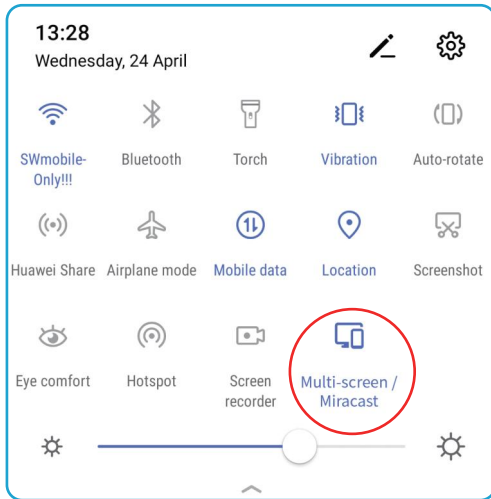

Notes:

- (1) Please make sure your Android devices support Miracast function.
- (2) To make the connection between your android device and the projector more stable, it's suggested that both projector and your Android device should share the same home WiFi. When connecting the projector to home WiFi, the tips are the same as Step 1 in IOS WIFI DISPLAY.

DLAN CONNECTION

Step 1: Turn on the projector and Click [**Setting**], Connect the projector to you Home WiFi. The wifi connection steps are same with iOS WiFi Connection Step 1.

Step 2: Connect your smartphone to the same Home WiFi name.

Step 3: Click [**DLAN**] on the projector.

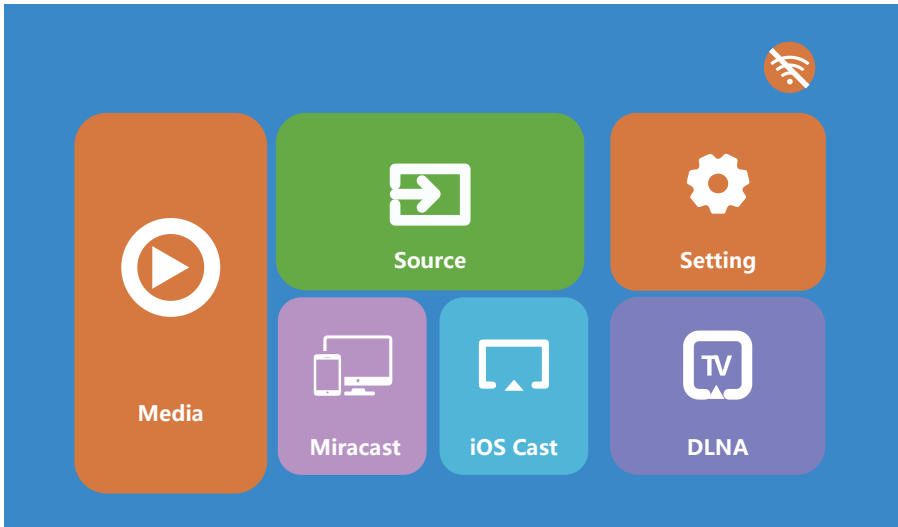

Step 4: Open your video player and click the TV icon, select the projector name such as mcast-58e1, after that the connection will be successful.

OTHER CONNECTION METHOD

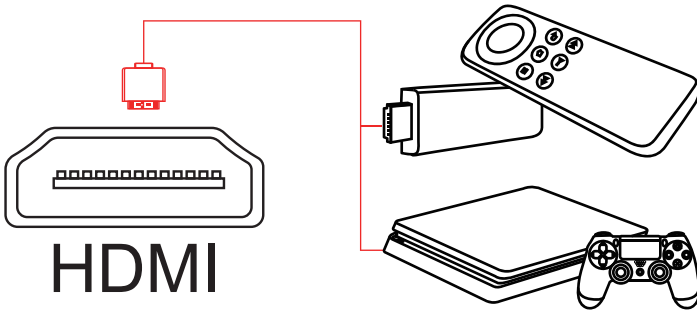

Home
HDMI
AV
PC

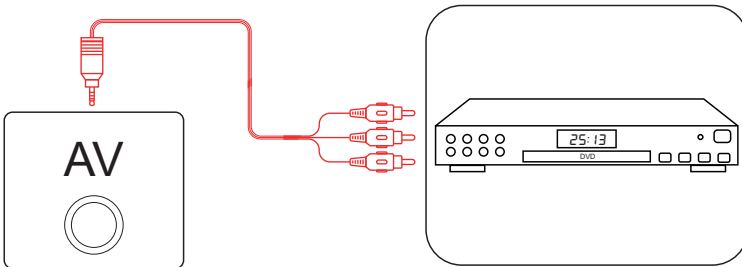

Home
HDMI
AV
PC



Home
HDMI
USB
PC
AV

BASIC OPERATION

1. Focus & Keystone

- 1) Rotate the lens to get the image in focus and have the best picture quality.
- 2) Rotate the keystone to get horizontal projection screen.

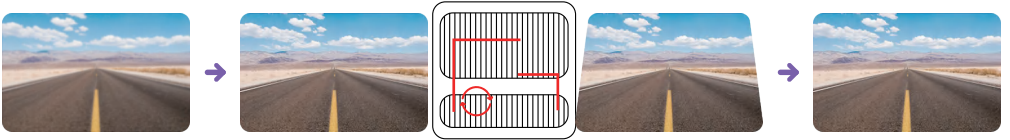

2. Projection Modes

Notes: Press Menu button, Click Setup, find Projection to choose the projection mode per you needs.

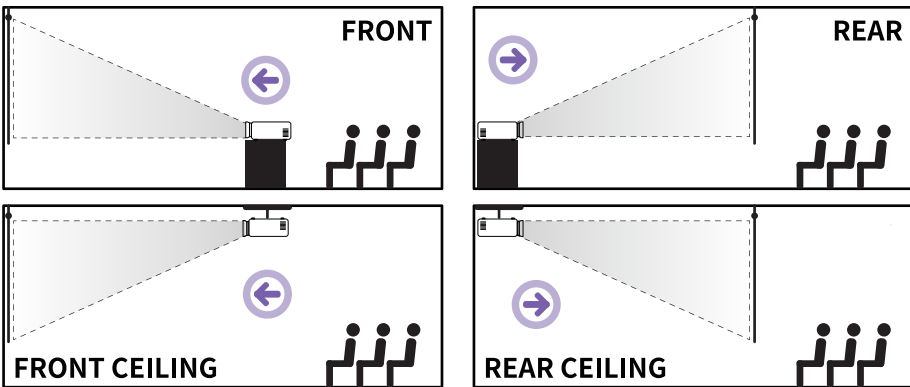

3. Projection Distance & Size

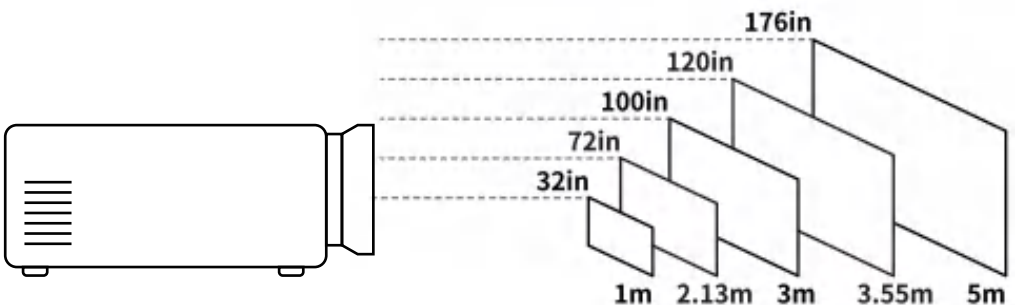

BASIC SETTINGS

1. Bluetooth Settings

Connect your Bluetooth speaker to your projector via Bluetooth mode.
Find the Bluetooth icon and click it under Setting:

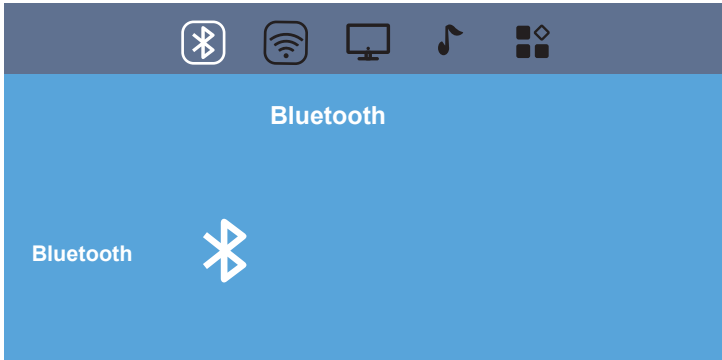

Press the “Right or Left” button to turn on OR turn off the Bluetooth mode:

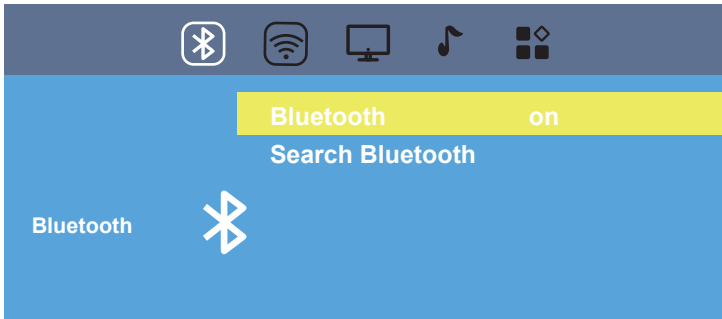

Turn on the Bluetooth mode. Please Search Bluetooth to find your Bluetooth speaker:

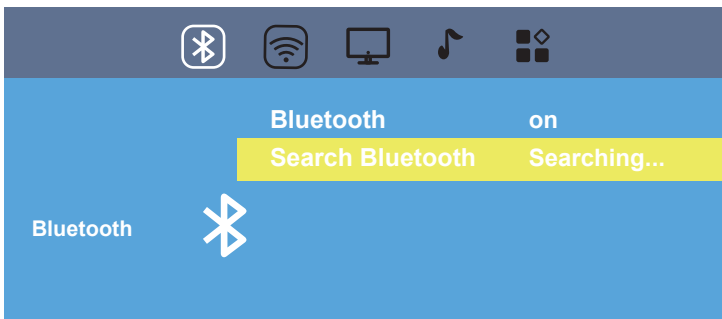

Find your Bluetooth device and then press OK button to connect your Bluetooth device:

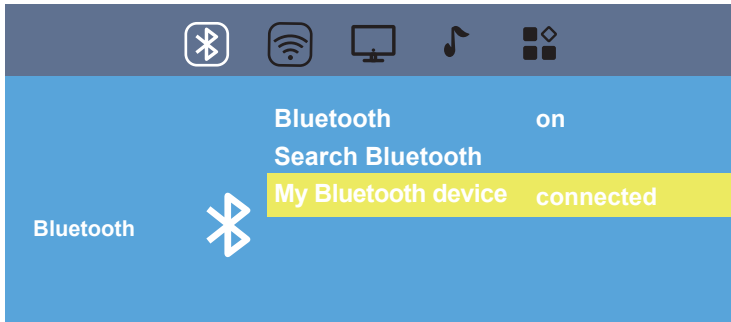

The Bluetooth icon will show up at the right corner of Home Page after the Bluetooth is successfully connected.

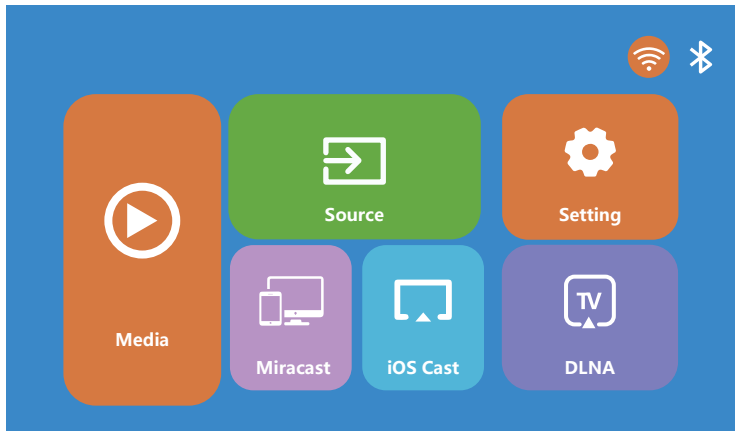

2. Picture Settings

Set up contrast, brightness, color, sharpness under picture mode-user mode;

Switch color temperature to medium ,warm, user and cool to meet different usage. Warm is good for movies and cool is great for image display.

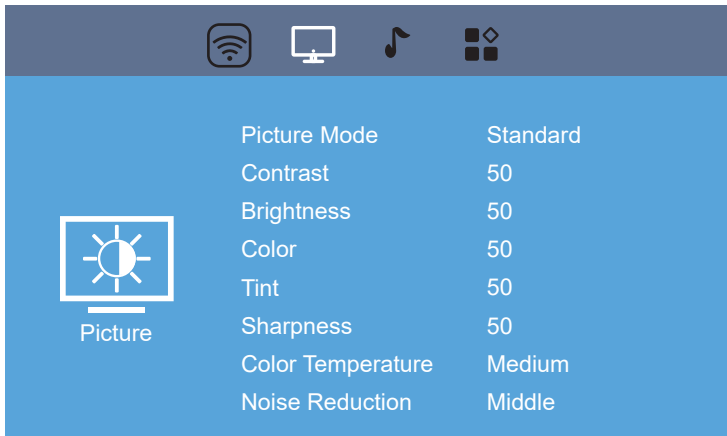

3.Sound Settings

Set up sound patterns of standard, music, movie, sports and user undersound mode;

Balance is to balance the sound of the left and right channel of the speaker.

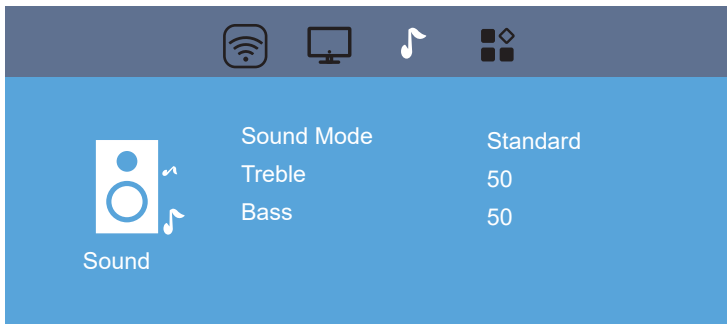

4.Advanced Settings

Language setting is under OSD Language;

To reset the projector, choose restore factory ;

For software update, contact customer service before you update.

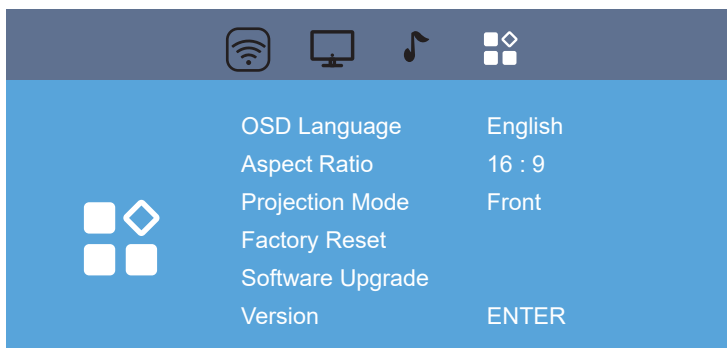

QUICK GUIDE TO CLEAN THE DIRT SPOT ON THE SCREEN

Step 1

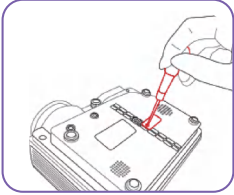

1. Open the Dedusting hole under the projector (you can find the screw hole directly under the projector or tear off the label of the projector according to product model.)

Step 2

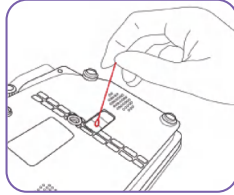

2. Turn on the projector and insert the cotton swab into the projector LCD Part.

Step 3

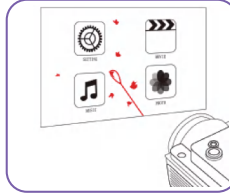

3. Move the cotton swab to the dirt spot part and wipe it gently.

Step 4

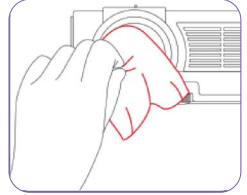

4. please use the dustless cloth to clean the lens.

Warm Tips:

Cause of air-cooling heat dissipation system of the projector, dust may settle onto the surfaces of LCD Screen depends on the environment.

If there have a dirty spot on the projector screen , please use the dust-free cotton swab to clean it from the dedusting hole.

Thank you!

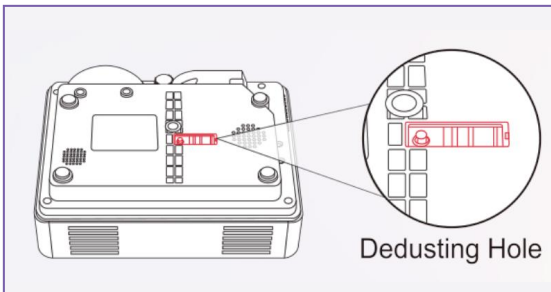

Any question, please contact us.

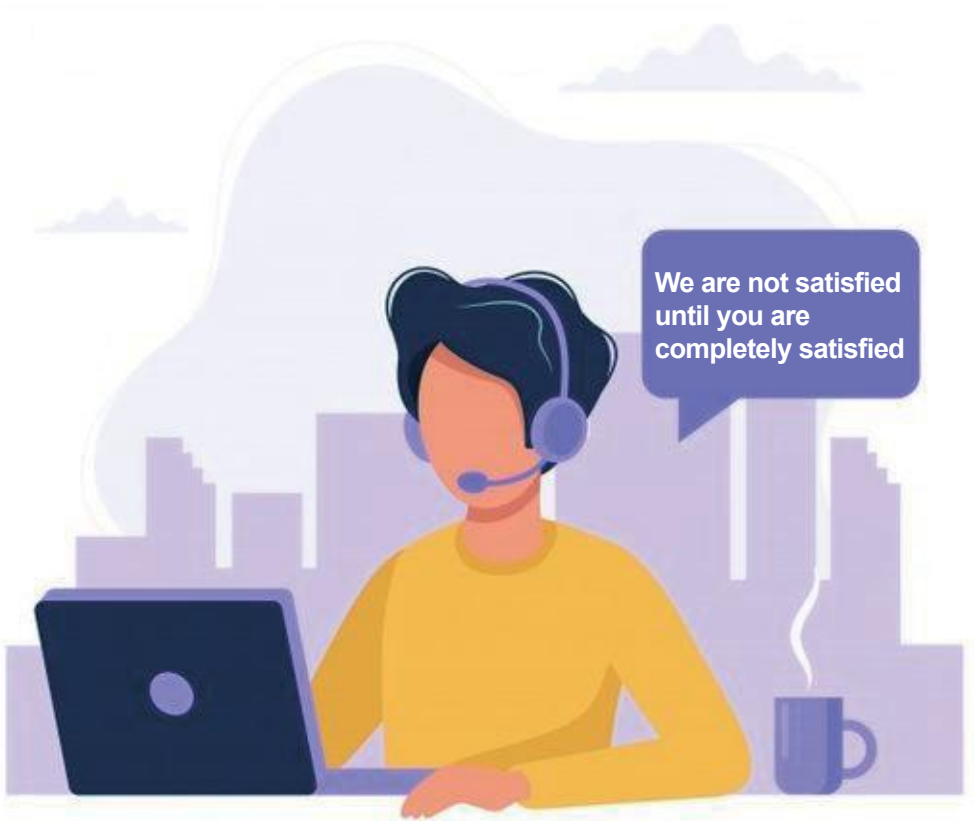

We are not satisfied
until you are
completely satisfied

Federal Communications Commission (FCC) Statement

This device complies with part 15 of the FCC Rules. Operation is subject to the following two conditions: (1) This device may not cause harmful interference, and (2) this device must accept any interference received, including interference that may cause undesired operation.

Note: This equipment has been tested and found to comply with the limits for a Class B digital device, pursuant to part 15 of the FCC Rules. These limits are designed to provide reasonable protection against harmful interference in a residential installation. This equipment generates, uses and can radiate radio frequency energy and, if not installed and used in accordance with the instructions, may cause harmful interference to radio communications. However, there is no guarantee that interference will not occur in a particular installation. If this equipment does cause harmful interference to radio or television reception, which can be determined by turning the equipment off and on, the user is encouraged to try to correct the interference by one or more of the following measures:

- Reorient or relocate the receiving antenna.
- Increase the separation between the equipment and receiver.
- Connect the equipment into an outlet on a circuit different from that to which the receiver is connected.
- Consult the dealer or an experienced radio/TV technician for help.

Warning: Changes or modifications made to this device not expressly approved by **Dongguan kuayue Intelligent Technology Co., LTD.** may void the FCC authorization to operate this device.

Note: The manufacturer is not responsible for any radio or TV interference caused by unauthorized modifications to this equipment. Such modifications could void the user's authority to operate the equipment.

RF exposure statement:

The transmitter must not be colocated or operated in conjunction with any other antenna or transmitter. This equipment complies with the FCC RF radiation exposure limits set forth for an uncontrolled environment. This equipment should be installed and operated with a Minimum distance of 20cm between the radiator and any part of your body.