

# Antenna Information

Item	Contents
Antenna Type	PCB Pattern Antenna
Antenna peak gain	-0.50 dB i
Manufacturer / Model name	BDE Technology Co., Ltd / -
Address of manufacturer	Innovation Building C1-1105 182 Science Ave, Science City Guangzhou, China, 510663
Test Laboratory	BDE Technology Co., Ltd
Antenna Length	0.4 cm
Antenna Width	1 cm

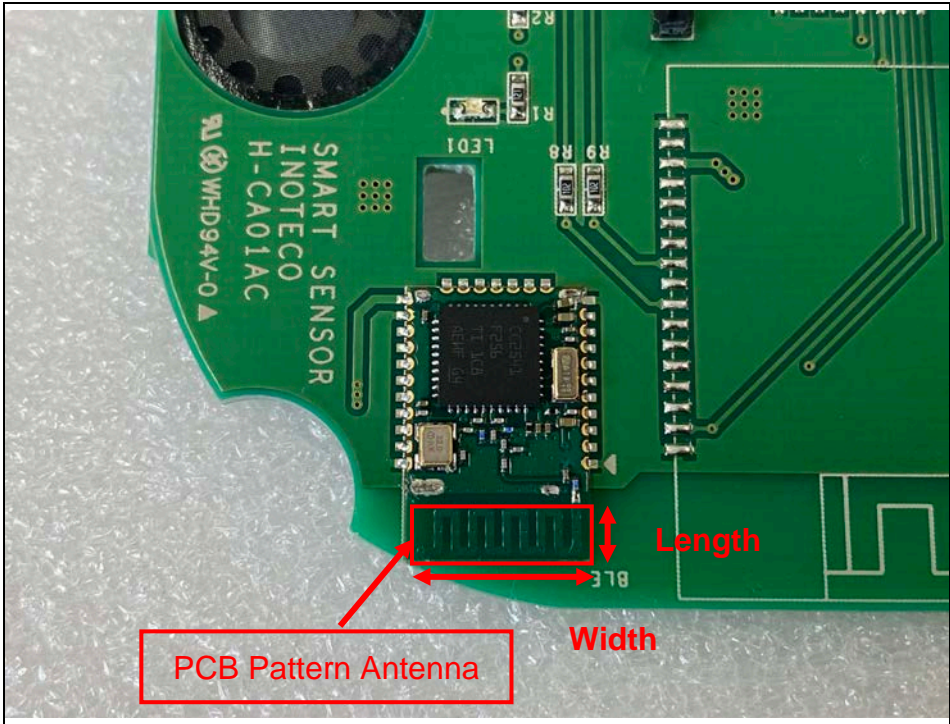

# Antenna Specification

## BDE-BLEM201P

### 1. Mechanical Dimension

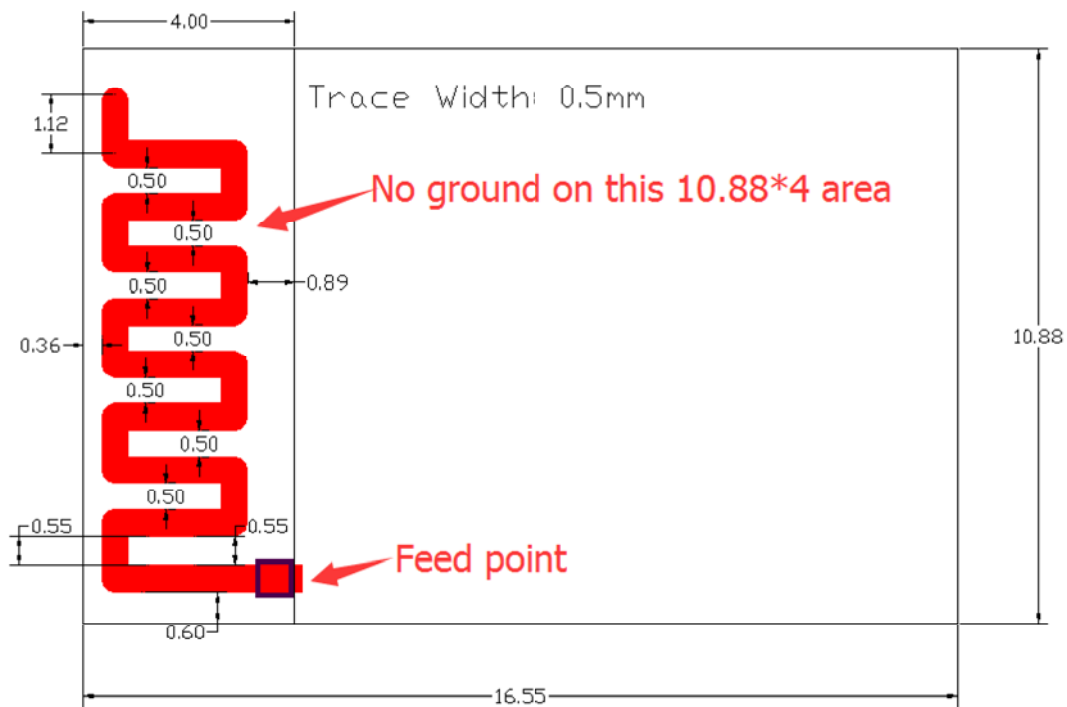

All dimensions are in mm

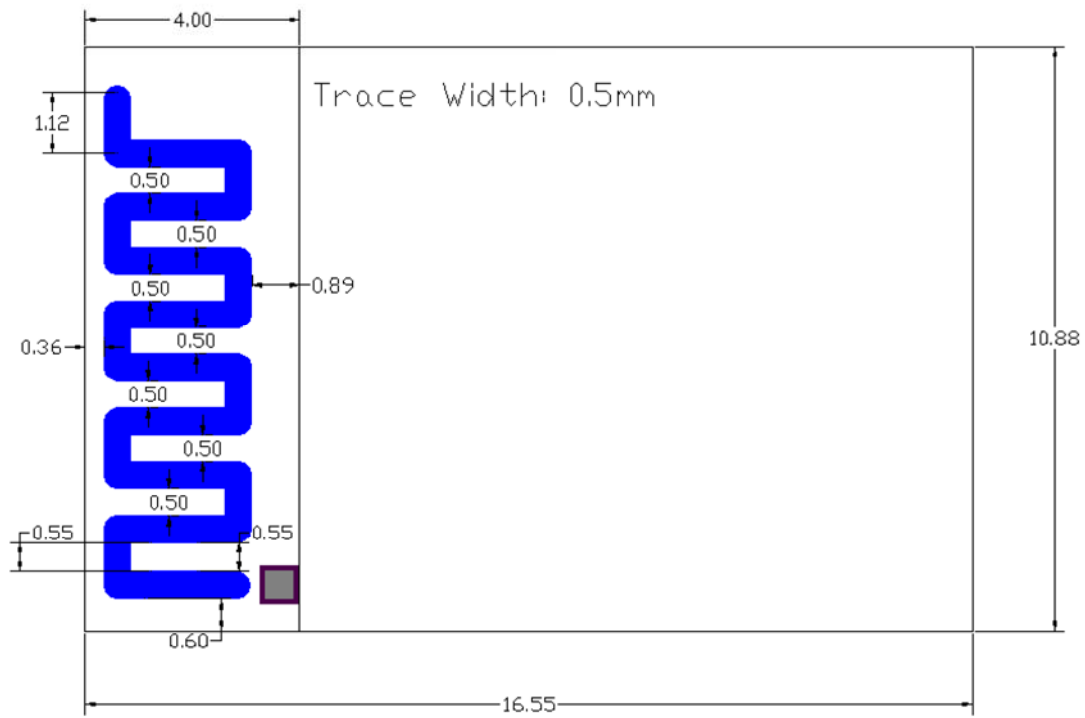

## 2. Gain and Efficiency

Frequency	Gain	Efficiency
2400MHz	-2.76	20.61%
2410MHz	-3.20	23.41%
2420MHz	-1.13	33.30%
2430MHz	-1.73	30.18%
2440MHz	-2.81	22.94%
2450MHz	-2.89	23.60%
2460MHz	-2.02	30.80%
2470MHz	-1.30	36.02%
2480MHz	-0.50	33.79%

### 3. Radiation Pattern

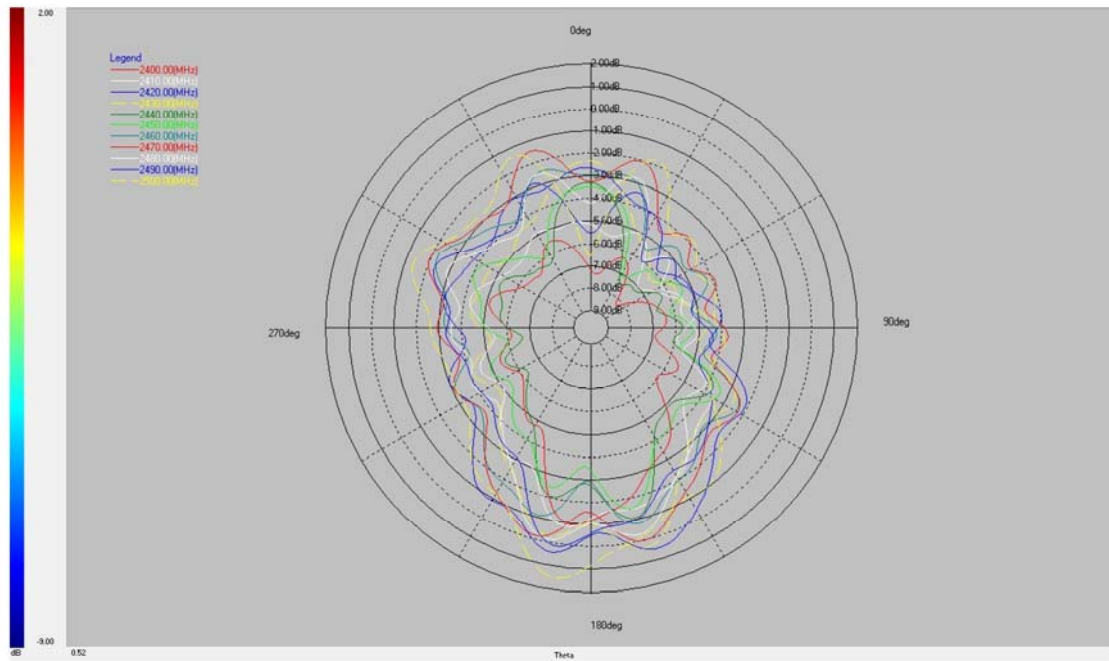
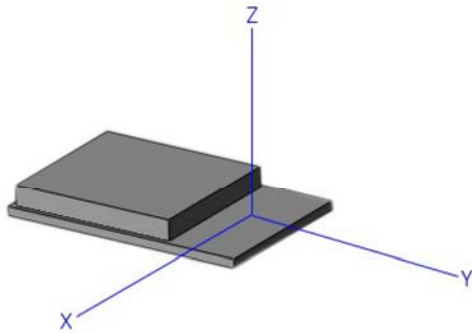

XZ plane (Phi = 0°)

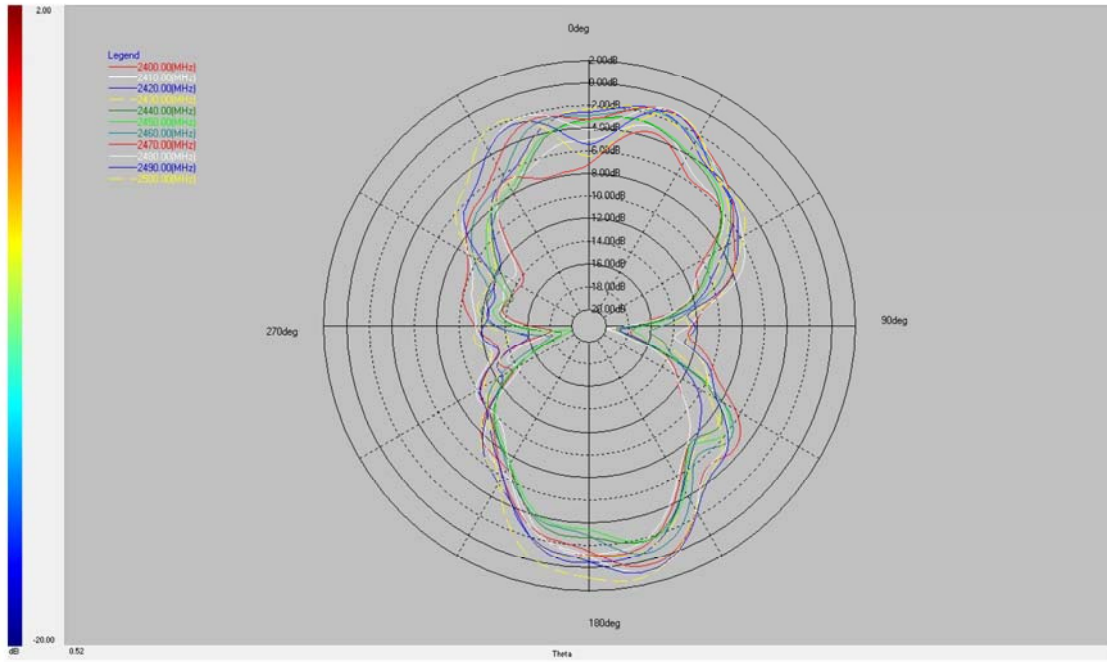

YZ plane (Phi = 90°)

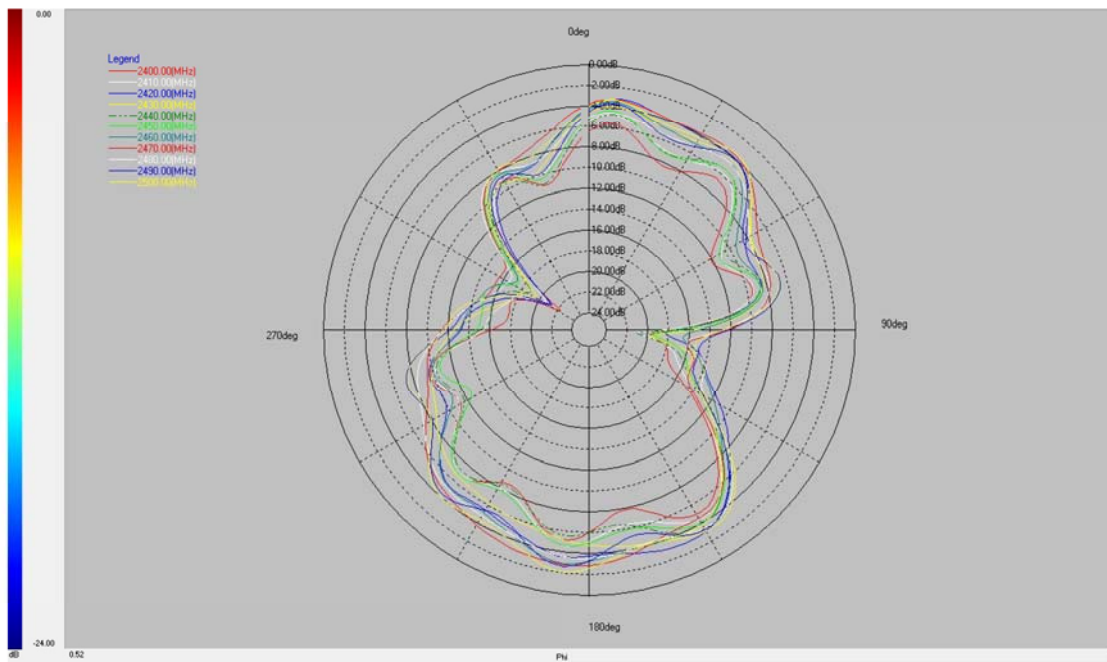

XY plane (Theta = 90°)