

# FCC Radio Test Report

## FCC ID: ZMONL668LA05

**This report concerns: Original Grant**

**Project No.** : 2111C171  
**Equipment** : LTE Module  
**Brand Name** : Fibocom  
**Test Model** : NL668-LA  
**Series Model** : NL668-LA-05, NL668-LA-10, NL668-LA-30  
**Applicant** : Fibocom Wireless Inc.  
**Address** : 1101, Tower A, Building 6, Shenzhen International Innovation Valley, Dashi 1st Rd, Nanshan, Shenzhen, China  
**Manufacturer** : Fibocom Wireless Inc.  
**Address** : 1101, Tower A, Building 6, Shenzhen International Innovation Valley, Dashi 1st Rd, Nanshan, Shenzhen, China  
**Factory** : Huizhou HYE Technology Co., Ltd.  
**Address** : No. 237, Sanhe group, Sanhe village, Tonghu Town, Zhongkai hi tech Zone, Huizhou  
**Date of Receipt** : Nov. 29, 2021  
**Date of Test** : Dec. 03, 2021 ~ Dec. 31, 2021  
**Issued Date** : Feb. 14, 2022  
**Report Version** : R00  
**Test Sample** : Engineering Sample No.: DG20211201108 for conducted, DG20211201110 for radiated.  
**Standard(s)** : 47 CFR FCC Part 22 Subpart H  
47 CFR FCC Part 2  
ANSI/TIA/EIA-603-E-2016  
FCC KDB 971168 D01 Power Meas License Digital Systems v03r01

The above equipment has been tested and found compliance with the requirement of the relative standards by BTL Inc.

*Gabriel Zhu*

Prepared by : Gabriel Zhu

*Steven Lu*

Approved by : Steven Lu



TESTING CERT #5123.02

Add: No. 3 Jinshagang 1st Rd. Shixia, Dalang Town Dongguan City, Guangdong 523792  
People's Republic of China.

Tel: +86-769-8318-3000

Web: [www.newbtl.com](http://www.newbtl.com)

**Declaration**

**BTL** represents to the client that testing is done in accordance with standard procedures as applicable and that test instruments used has been calibrated with standards traceable to international standard(s) and/or national standard(s).

**BTL's** reports apply only to the specific samples tested under conditions. It is manufacture's responsibility to ensure that additional production units of this model are manufactured with the identical electrical and mechanical components. **BTL** shall have no liability for any declarations, inferences or generalizations drawn by the client or others from **BTL** issued reports.

The report must not be used by the client to claim product certification, approval, or endorsement by NIST, A2LA, or any agency of the U.S. Government.

This report is the confidential property of the client. As a mutual protection to the clients, the public and ourselves, the test report shall not be reproduced, except in full, without our written approval.

**BTL's** laboratory quality assurance procedures are in compliance with the **ISO/IEC 17025** requirements, and accredited by the conformity assessment authorities listed in this test report.

**BTL** is not responsible for the sampling stage, so the results only apply to the sample as received.

The information, data and test plan are provided by manufacturer which may affect the validity of results, so it is manufacturer's responsibility to ensure that the apparatus meets the essential requirements of applied standards and in all the possible configurations as representative of its intended use.

**Limitation**

For the use of the authority's logo is limited unless the Test Standard(s)/Scope(s)/Item(s) mentioned in this test report is (are) included in the conformity assessment authorities acceptance respective.

Please note that the measurement uncertainty is provided for informational purpose only and is not use in determining the Pass/Fail results.

<b>Table of Contents</b>	<b>Page</b>
<b>REPORT ISSUED HISTORY</b>	<b>5</b>
<b>1 . SUMMARY OF TEST RESULTS</b>	<b>6</b>
1.1 TEST FACILITY	7
1.2 MEASUREMENT UNCERTAINTY	7
1.3 TEST ENVIRONMENT CONDITIONS	8
<b>2 . GENERAL INFORMATION</b>	<b>9</b>
2.1 GENERAL DESCRIPTION OF EUT	9
2.2 DESCRIPTION OF TEST MODES	11
2.3 BLOCK DIGRAM SHOWING THE CONFIGURATIONOFSYSTEMTESTED	13
2.4 DESCRIPTION OF SUPPORT UNITS	13
<b>3 . TEST RESULT</b>	<b>14</b>
3.1 OUTPUT POWER MEASUREMENT	14
3.1.1 LIMIT	14
3.1.2 TEST PROCEDURE	14
3.1.3 TEST SETUP LAYOUT	14
3.1.4 TEST DEVIATION	14
3.1.5 TEST RESULTS	14
3.2 OCCUPIED BANDWIDTH MEASUREMENT	15
3.2.1 TEST PROCEDURE	15
3.2.2 TEST SETUP LAYOUT	15
3.2.3 TEST DEVIATION	15
3.2.4 TEST RESULTS	15
3.3 CONDUCTED SPURIOUS EMISSIONS MEASUREMENT	16
3.3.1 LIMIT	16
3.3.2 TEST PROCEDURES	16
3.3.3 TEST SETUP LAYOUT	16
3.3.4 TEST DEVIATION	16
3.3.5 TEST RESULTS	16
3.4 RADIATED SPURIOUS EMISSIONS MEASUREMENT	17
3.4.1 LIMIT	17
3.4.2 TEST PROCEDURES	17
3.4.3 TEST SETUP LAYOUT	18
3.4.4 TEST DEVIATION	19
3.4.5 TEST RESULTS (9KHZ TO 30MHZ)	19
3.4.6 TEST RESULTS (30MHZ TO 1000MHZ)	19
3.4.7 TEST RESULTS (ABOVE 1000MHZ)	19
3.5 BAND EDGE MEASUREMENT	20
3.5.1 LIMIT	20
3.5.2 TEST PROCEDURES	20

<b>Table of Contents</b>	<b>Page</b>
3.5.3 TEST SETUP LAYOUT	20
3.5.4 TEST DEVIATION	20
3.5.5 TEST RESULTS	20
3.6 PEAK TO AVERAGE RATIO MEASUREMENT	21
3.6.1 LIMIT	21
3.6.2 TEST PROCEDURES	21
3.6.3 TEST SETUP LAYOUT	21
3.6.4 TEST DEVIATION	21
3.6.5 TEST RESULTS	21
3.7 FREQUENCY STABILITY MEASUREMENT	22
3.7.1 LIMIT	22
3.7.2 TEST PROCEDURES	22
3.7.3 TEST SETUP LAYOUT	22
3.7.4 TEST DEVIATION	22
3.7.5 TEST RESULTS	22
4. LIST OF MEASUREMENT EQUIPMENTS	23
5. EUT TEST PHOTO	25
APPENDIX A - OUTPUT POWER	29
APPENDIX B - OCCUPIED BANDWIDTH	36
APPENDIX C - CONDUCTED SPURIOUS EMISSIONS	44
APPENDIX D - RADIATED SPURIOUS EMISSIONS (9KHZ TO 30MHZ)	48
APPENDIX E - RADIATED SPURIOUS EMISSIONS (30MHZ TO 1000MHZ)	50
APPENDIX F - RADIATED SPURIOUS EMISSIONS (ABOVE 1000MHZ)	54
APPENDIX G - BAND EDGE	58
APPENDIX H - PEAK TO AVERAGE RATIO	65
APPENDIX I - FREQUENCY STABILITY	73

**REPORT ISSUED HISTORY**

Report Version	Description	Issued Date
R00	Original Issue.	Feb. 14, 2022

## 1. SUMMARY OF TEST RESULTS

Test procedures according to the technical standard(s):

FCC Part 22 Subpart H & Part 2			
Standard(s) Section	Test Item	Judgment	Remark
2.1046 22.913(a)(5)	Effective Radiated Power	PASS	-----
2.1049	Occupied Bandwidth	PASS	-----
2.1051 22.917(a)	Conducted Spurious Emissions	PASS	-----
2.1053 22.917(a)	Radiated Spurious Emissions	PASS	-----
22.917(a)	Band Edge Measurements	PASS	-----
-	Peak To Average Ratio	PASS	Record Only
2.1055 22.355	Frequency Stability	PASS	-----

Note:

(1) "N/A" denotes test is not applicable in this test report.

### 1.1 TEST FACILITY

The test facilities used to collect the test data of radiated in this report is at the location of No. 3 Jinshagang 1st Rd. Shixia, Dalang Town Dongguan City, Guangdong 523792 People's Republic of China.

The test facilities used to collect the test data of conducted in this report is at the location of Room 108, Building 2, No.1, Yile Road, Songshan Lake Zone, Dongguan City, Guangdong, People's Republic of China.

BTL's Test Firm Registration Number for FCC: 357015

BTL's Designation Number for FCC: CN1240

### 1.2 MEASUREMENT UNCERTAINTY

ISO/IEC 17025 requires that an estimate of the measurement uncertainties associated with the emissions test results be included in the report. The measurement uncertainties given below are based on a 95% confidence level (based on a coverage factor (k=2))

The BTL measurement uncertainty as below table:

#### A. Radiated Measurement:

Test Site	Method	Measurement Frequency Range	U,(dB)
DG-CB01	CISPR	9kHz ~ 30MHz	2.36

Test Site	Method	Measurement Frequency Range	Ant. H / V	U,(dB)
DG-CB03	CISPR	30MHz ~ 200MHz	V	4.36
		30MHz ~ 200MHz	H	3.32
		200MHz ~ 1,000MHz	V	4.08
		200MHz ~ 1,000MHz	H	3.96
		1GHz ~ 6GHz	-	3.80
		6GHz ~ 18GHz	-	4.82

#### B. Other Measurement:

Parameter	Uncertainty
Spectrum Bandwidth	±3.8 %
Maximum Output Power	±0.95 dB
Power Spectral Density	±0.86 dB
Frequency Stability	±0.16 dB
Temperature	±0.08 °C
Time	±0.58 %
Supply voltages	±0.3 %

Note: Unless specifically mentioned, the uncertainty of measurement has not been taken into account to declare the compliance or non-compliance to the specification.

### 1.3 TEST ENVIRONMENT CONDITIONS

Test Item	Temperature	Humidity	Test Voltage	Tested By
Output Power & ERP	23°C	44%	DC 3.8V	Rick Liao
Occupied Bandwidth	23°C	44%	DC 3.8V	Rick Liao
Conducted Spurious Emissions	23°C	44%	DC 3.8V	Rick Liao
Radiated Spurious Emissions (9 kHz to 30 MHz)	22°C	50%	DC 3.8V	Kwok Guo
Radiated Spurious Emissions (30 MHz to 1000 MHz)	22°C	50%	DC 3.8V	Kwok Guo
Radiated Spurious Emissions (Above 1000 MHz)	22°C	50%	DC 3.8V	Kwok Guo
Band Edge	23°C	44%	DC 3.8V	Rick Liao
Peak to Average Ratio	23°C	44%	DC 3.8V	Rick Liao
Frequency Stability	Normal & Extreme	44%	Normal & Extreme	Rick Liao



## 2. GENERAL INFORMATION

### 2.1 GENERAL DESCRIPTION OF EUT

Equipment	LTE Module			
Brand Name	Fibocom			
Test Model	NL668-LA			
Series Model	NL668-LA-05, NL668-LA-10, NL668-LA-30			
Model Difference(s)	Only differ in memory.			
Hardware Version	V1.0.0			
Software Version	19005.1000.15.02.00.05			
Power Source	DC voltage supplied from external power supply.			
Power Rating	DC 3.3V~4.3V			
IMEI No.	Radiated	860333050418759		
	Conducted	860333050419385		
Modulation Type	GSM/GPRS	GMSK		
	EDGE	GMSK, 8PSK		
	WCDMA/HSDPA/HSUPA	UL: QPSK DL: QPSK, 16QAM		
	LTE	UL: QPSK, 16QAM DL: QPSK, 16QAM, 64QAM		
Max. ERP	GSM 850 / GPRS 850	GMSK	28.17	dBm
	EDGE 850	8PSK	23.16	dBm
	WCDMA Band V	QPSK	20.23	dBm
	HSDPA Band V	QPSK	19.26	dBm
	HSUPA Band V	QPSK	19.22	dBm
	LTE	Channel Bandwidth (MHz)	QPSK (dBm)	16QAM (dBm)
	Band 5	1.4	19.22	18.54
		3	19.35	18.71
		5	19.20	18.45
10		19.26	18.50	

**Note:**

1. For a more detailed features description, please refer to the manufacturer's specifications or the user's manual.

**2. Channel List:**

GSM 850				
Test Frequency ID	UARFCN	Frequency of Uplink (MHz)	UARFCN	Frequency of Downlink (MHz)
Low Range	128	824.2	137	869.2
Mid Range	190	836.6	199	881.6
High Range	251	848.8	260	893.8

WCDMA Band V				
Test Frequency ID	UARFCN	Frequency of Uplink (MHz)	UARFCN	Frequency of Downlink (MHz)
Low Range	4132	826.4	4357	871.4
Mid Range	4182	836.4	4407	881.4
High Range	4233	846.6	4458	891.6

LTE Band 5					
Test Frequency ID	Bandwidth (MHz)	N <sub>UL</sub>	Frequency of Uplink (MHz)	N <sub>DL</sub>	Frequency of Downlink (MHz)
Low Range	1.4	20407	824.7	2407	869.7
	3	20415	825.5	2415	870.5
	5	20425	826.5	2425	871.5
	10	20450	829	2450	874
Mid Range	1.4/3/5/10	20525	836.5	2525	881.5
High Range	1.4	20643	848.3	2643	893.3
	3	20635	847.5	2635	892.5
	5	20625	846.5	2625	891.5
	10	20600	844	2600	889

**3. Table for Filed Antenna:**

Brand	Model Name	Antenna Type	Connector	Gain (dBi)	Note
N/A	N/A	Dipole	SMA	-1.4	GSM 850
N/A	N/A	Dipole	SMA	-1.4	WCDMA Band V
N/A	N/A	Dipole	SMA	-1.4	LTE Band 5

Note: The antenna gain is provided by the manufacturer.

## 2.2 DESCRIPTION OF TEST MODES

Following mode(s) is (were) found to be the worst case(s) and selected for the final test.

<b>GSM MODE</b>			
Test Item	Available Channel	Tested Channel	Mode
Output Power & ERP	128 to 251	128, 190, 251	GSM, GPRS, EDGE
Occupied Bandwidth	128 to 251	128, 190, 251	GSM, EDGE
Conducted Spurious Emissions	128 to 251	190	GSM, EDGE
Radiated Spurious Emissions	128 to 251	190	GSM
Band Edge	128 to 251	128, 251	GSM, EDGE
Peak to Average Ratio	128 to 251	128, 190, 251	GSM, EDGE
Frequency Stability	128 to 251	190	GSM

<b>WCDMA BAND V MODE</b>			
Test Item	Available Channel	Tested Channel	Mode
Output Power & ERP	4132 to 4233	4132, 4182, 4233	WCDMA, HSDPA, HSUPA
Occupied Bandwidth	4132 to 4233	4132, 4182, 4233	WCDMA
Conducted Spurious Emissions	4132 to 4233	4182	WCDMA
Radiated Spurious Emissions	4132 to 4233	4182	WCDMA
Band Edge	4132 to 4233	4132, 4233	WCDMA
Peak to Average Ratio	4132 to 4233	4132, 4182, 4233	WCDMA
Frequency Stability	4132 to 4233	4182	WCDMA

LTE BAND 5 MODE					
Test Item	Available Channel	Tested Channel	Channel Bandwidth	Modulation	Mode
Output Power & ERP	20407 to 20643	20407, 20525, 20643	1.4MHz	QPSK, 16QAM	1RB/3RB/6RB
	20415 to 20635	20415, 20525, 20635	3MHz	QPSK, 16QAM	1RB/8RB/15RB
	20425 to 20625	20425, 20525, 20625	5MHz	QPSK, 16QAM	1RB/12RB/25RB
	20450 to 20600	20450, 20525, 20600	10MHz	QPSK, 16QAM	1RB/25RB/50RB
Occupied Bandwidth	20407 to 20643	20407, 20525, 20643	1.4MHz	QPSK, 16QAM	6RB
	20415 to 20635	20415, 20525, 20635	3MHz	QPSK, 16QAM	15RB
	20425 to 20625	20425, 20525, 20625	5MHz	QPSK, 16QAM	25RB
	20450 to 20600	20450, 20525, 20600	10MHz	QPSK, 16QAM	50RB
Conducted Spurious Emissions	20407 to 20643	20525	1.4MHz	QPSK	1RB
	20425 to 20625	20525	5MHz	QPSK	1RB
	20450 to 20600	20525	10MHz	QPSK	1RB
Radiated Spurious Emissions	20407 to 20643	20525	1.4MHz	QPSK	1RB
	20425 to 20625	20525	5MHz	QPSK	1RB
	20450 to 20600	20525	10MHz	QPSK	1RB
Band Edge	20407 to 20643	20407, 20643	1.4MHz	QPSK	1RB/6RB
	20415 to 20635	20415, 20635	3MHz	QPSK	1RB/15RB
	20425 to 20625	20425, 20625	5MHz	QPSK	1RB/25RB
	20450 to 20600	20450, 20600	10MHz	QPSK	1RB/50RB
Peak To Average Ratio	20407 to 20643	20407, 20525, 20643	1.4MHz	QPSK, 16QAM	1RB
	20415 to 20635	20415, 20525, 20635	3MHz	QPSK, 16QAM	1RB
	20425 to 20625	20425, 20525, 20625	5MHz	QPSK, 16QAM	1RB
	20450 to 20600	20450, 20525, 20600	10MHz	QPSK, 16QAM	1RB
Frequency Stability	20450 to 20600	20525	10MHz	QPSK	1RB

### 2.3 BLOCK DIGRAM SHOWING THE CONFIGURATION OF SYSTEM TESTED

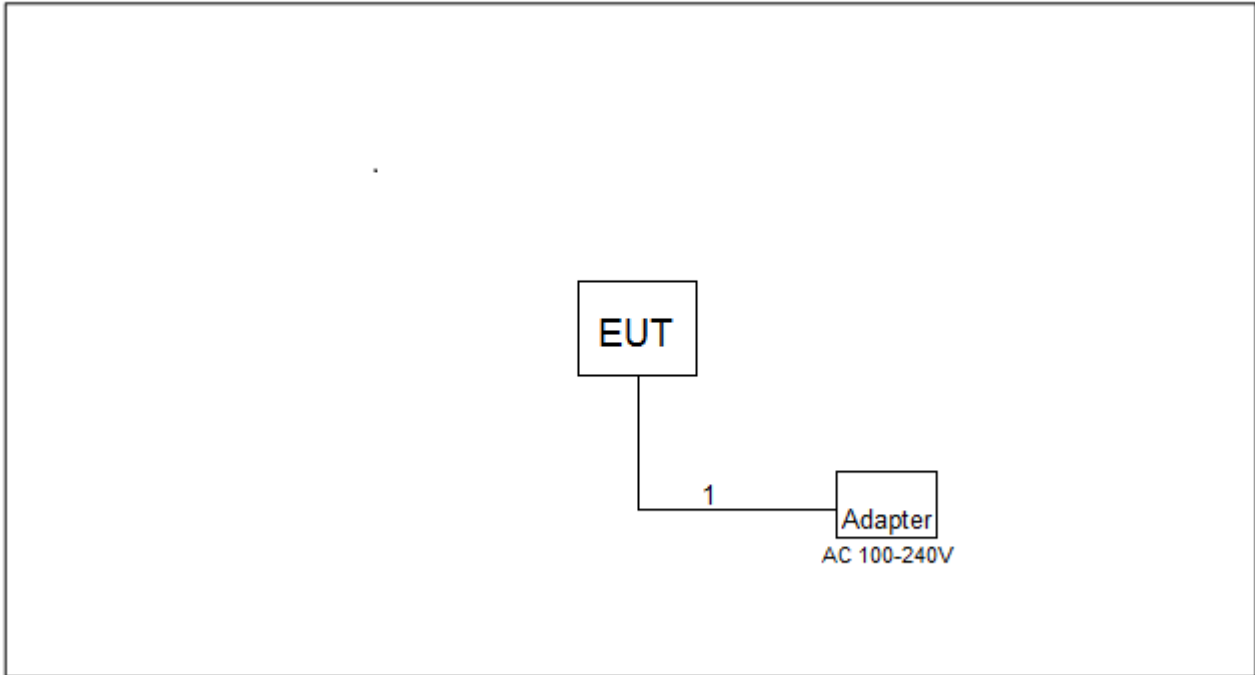

### 2.4 DESCRIPTION OF SUPPORT UNITS

The EUT has been tested as an independent unit together with other necessary accessories or support units. The following support units or accessories were used to form a representative test configuration during the tests.

Item	Equipment	Mfr/Brand	Model/Type No.	Series No.
-	Adapter	HUAWEI	HW-050100U01	-

Item	Cable Type	Shielded Type	Ferrite Core	Length
1	USB Cable	YES	NO	1.2m

### 3. TEST RESULT

#### 3.1 OUTPUT POWER MEASUREMENT

##### 3.1.1 LIMIT

Mobile / Portable station are limited to 7 watts e.r.p.

##### 3.1.2 TEST PROCEDURE

The testing follows FCC KDB 971168 v03r01 Section 5.

##### EIRP / ERP:

EIRP = Output Power + Antenan gain

ERP = EIPR - 2.15dBi

##### Output Power:

The EUT was set up for the maximum power with GSM, GPRS, EDGE, WCDMA and LTE link data modulation and link up with simulator. Set the EUT to transmit under low, middle and high channel and record the power level shown on simulator.

##### 3.1.3 TEST SETUP LAYOUT

##### Output Power Measurement

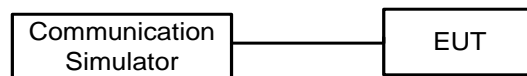

##### 3.1.4 TEST DEVIATION

No deviation

##### 3.1.5 TEST RESULTS

Please refer to the APPENDIX A.

### 3.2 OCCUPIED BANDWIDTH MEASUREMENT

#### 3.2.1 TEST PROCEDURE

The testing follows FCC KDB 971168 v03r01 Section 4.

1. The EUT makes a call to the communication simulator. All measurements were done at low, middle and high operational frequency range. The communication simulator station system controlled a EUT to export maximum output power under transmission mode and specific channel frequency. Use OBW measurement function of Spectrum analyzer to measure 99 % occupied bandwidth and 26dB bandwidth.
2. The EUT was connected to spectrum analyzer and system simulator via a power divider.
3.  $RBW=(1\% \sim 5\%)*EBW$   
 $VBW \geq 3* RBW$
4. Set spectrum analyzer with Peak detector.

#### 3.2.2 TEST SETUP LAYOUT

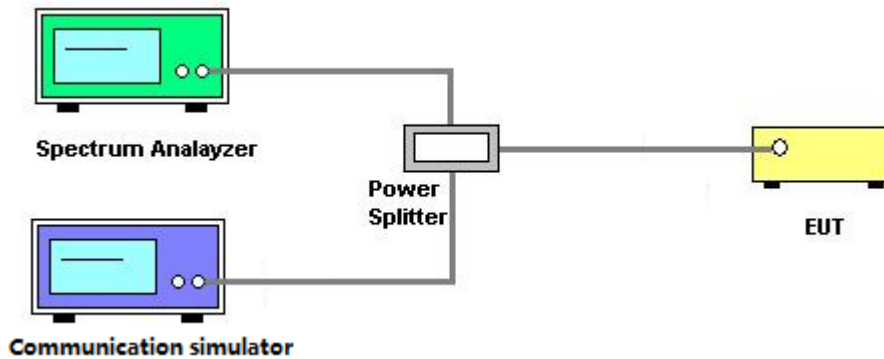

#### 3.2.3 TEST DEVIATION

No deviation

#### 3.2.4 TEST RESULTS

Please refer to the APPENDIX B.

### 3.3 CONDUCTED SPURIOUS EMISSIONS MEASUREMENT

#### 3.3.1 LIMIT

The power of any emission outside of the authorized operating frequency ranges must be attenuated below the transmitting power (P) by a factor of at least  $43 + 10 \log(P)$  dB. The emission limit equal to -13dBm.

#### 3.3.2 TEST PROCEDURES

The testing follows FCC KDB 971168 v03r01 Section 6.

1. The EUT was connected to spectrum analyzer and system simulator via a power divider.
2. The band edges of low and high channels for the highest RF powers were measured. Set RBW $\geq$ 1% EBW in the 1MHz band immediately outside and adjacent to the band edge.
3. Set spectrum analyzer with Peak detector.
4. The RF fundamental frequency should be excluded against the limit line in the operating frequency band.

#### 3.3.3 TEST SETUP LAYOUT

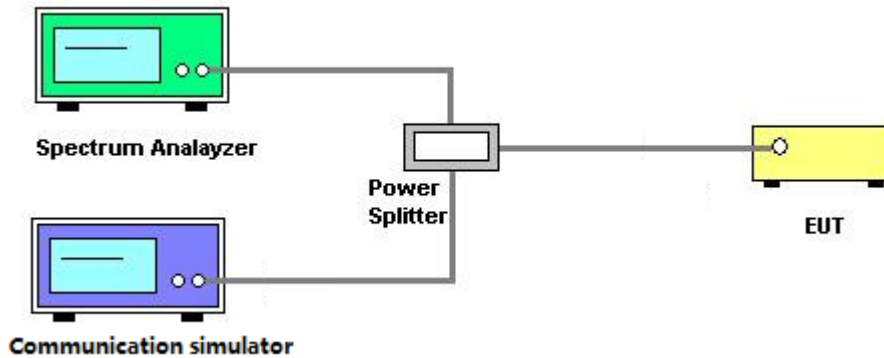

#### 3.3.4 TEST DEVIATION

No deviation

#### 3.3.5 TEST RESULTS

Please refer to the APPENDIX C.



### **3.4 RADIATED SPURIOUS EMISSIONS MEASUREMENT**

#### **3.4.1 LIMIT**

The power of any emission outside of the authorized operating frequency ranges must be attenuated below the transmitting power (P) by a factor of at least  $43 + 10 \log(P)$  dB. The emission limit equal to -13dBm.

#### **3.4.2 TEST PROCEDURES**

The testing follows FCC KDB 971168 v03r01 Section 6.2.

1. Substitution method is used for E.I.R.P measurement. In the semi-anechoic chamber, EUT placed on the 0.8m height of Turn Table, rotated the table around 360 degrees to search the maximum radiation power and receiver antenna shall be rotated vertical and horizontal polarization and moved height from 1m to 4m to find the maximum polar radiated power. The "Read Value" is the spectrum reading the maximum power value.
2. The substitution horn antenna is substituted for EUT at the same position and signals generator export the CW signal to the substitution antenna via a TX cable. Rotated the Turn Table and moved receiving antenna to find the maximum radiation power. Adjust output power level of S.G to get a Value of spectrum reading equal to "Read Value " of step a. Record the power level of S.G
3.  $EIRP = \text{Output power level of S.G} - \text{TX cable loss} + \text{Antenna gain of substitution horn.}$
4. ERP can be calculated form EIRP by subtracting the gain of dipole,  $ERP = EIPR - 2.15dBi.$
5. The resolution bandwidth and video bandwidth of test receiver/spectrum analyzer is 1MHz/3MHz.

### 3.4.3 TEST SETUP LAYOUT

#### Below 30MHz

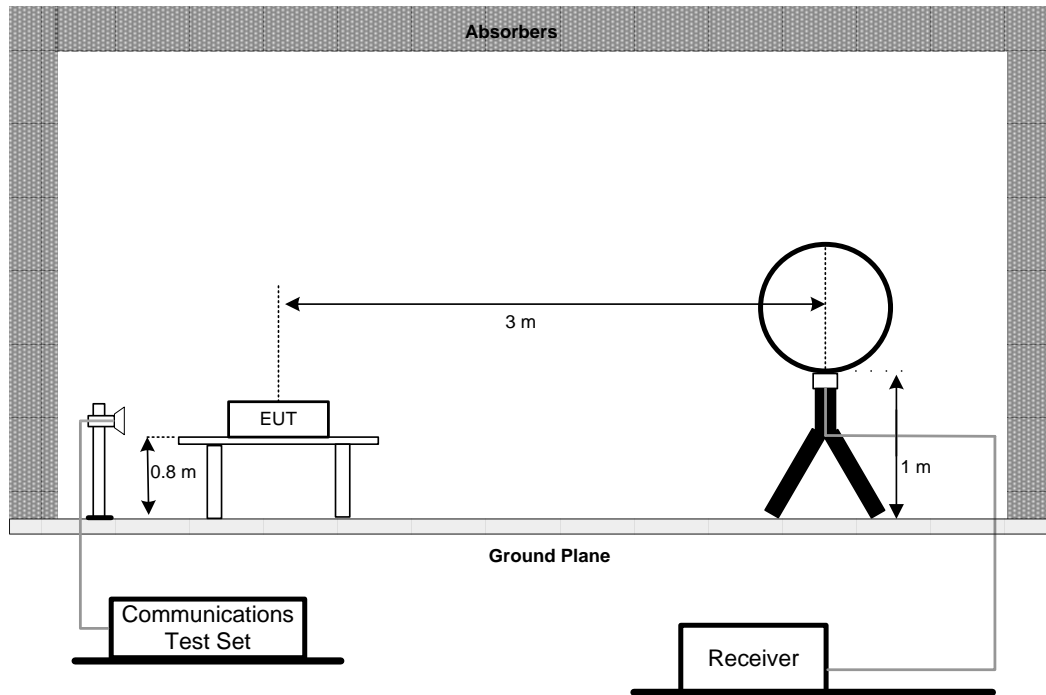

#### 30MHz to 1000MHz

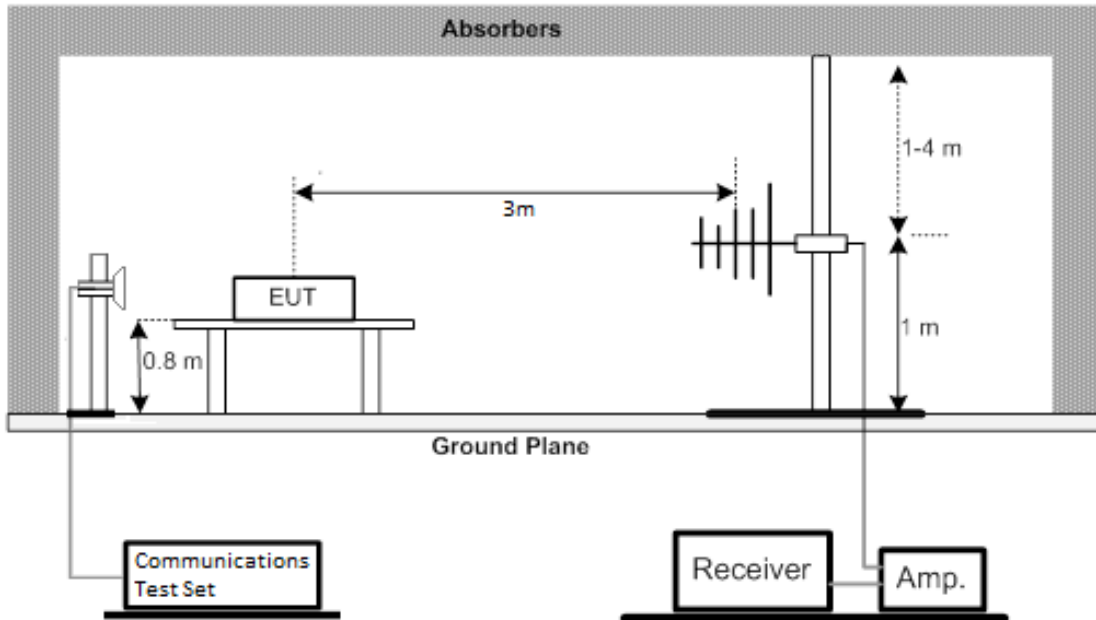

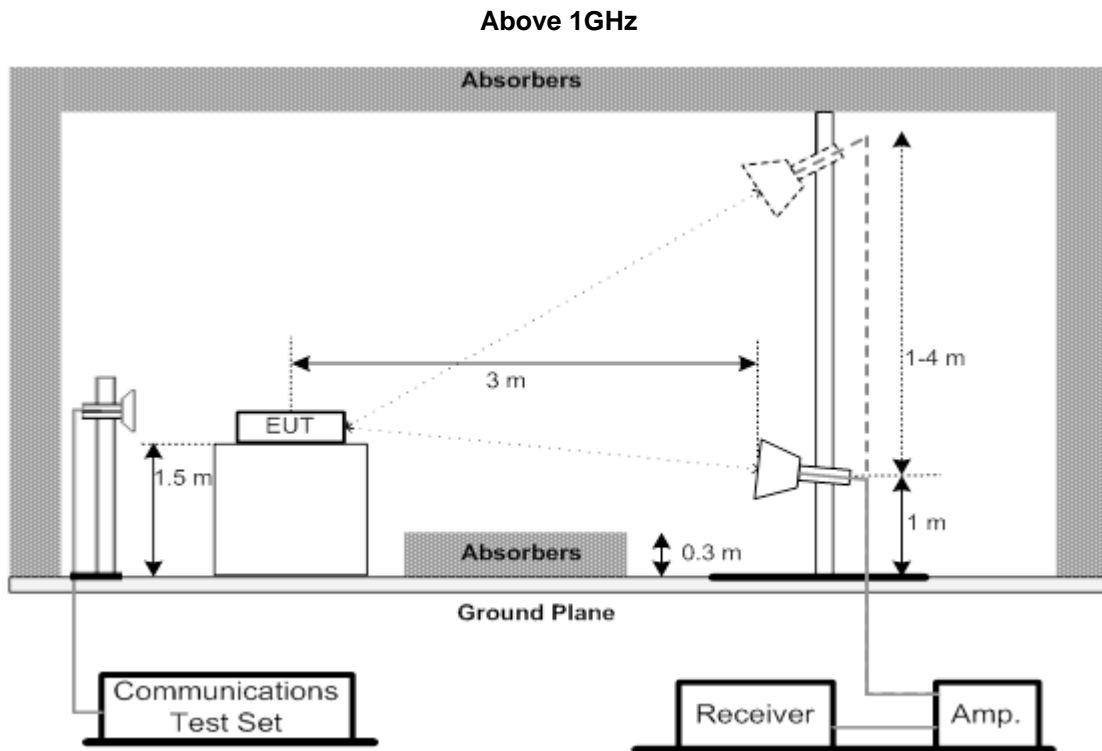

#### 3.4.4 TEST DEVIATION

No deviation

#### 3.4.5 TEST RESULTS (9KHZ TO 30MHZ)

Please refer to the APPENDIX D.

#### 3.4.6 TEST RESULTS (30MHZ TO 1000MHZ)

Please refer to the APPENDIX E.

#### 3.4.7 TEST RESULTS (ABOVE 1000MHZ)

Please refer to the APPENDIX F.

### 3.5 BAND EDGE MEASUREMENT

#### 3.5.1 LIMIT

A Power of any emission outside of the authorized operating frequency ranges must be attenuated below the transmitting power (P) by a factor of at least  $43 + 10 \log(P)$  dB. In the 1 MHz bands immediately outside and adjacent to the frequency block a resolution bandwidth of at least one percent of the emission bandwidth of the fundamental emission of the transmitter may be employed.

#### 3.5.2 TEST PROCEDURES

The testing follows FCC KDB 971168 v03r01 Section 6.

1. All measurements were done at low and high operational frequency range.
2. Record the max trace plot into the test report.

#### 3.5.3 TEST SETUP LAYOUT

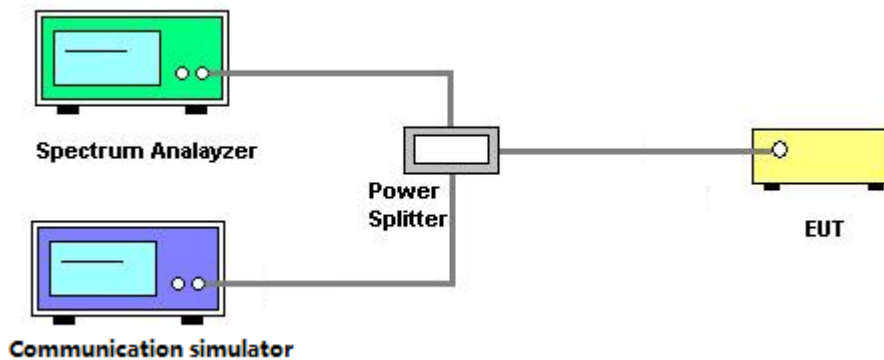

#### 3.5.4 TEST DEVIATION

No deviation

#### 3.5.5 TEST RESULTS

Please refer to the APPENDIX G.

### 3.6 PEAK TO AVERAGE RATIO MEASUREMENT

#### 3.6.1 LIMIT

In measuring transmissions in this band using an average power technique, the peak to-average ratio (PAR) of the transmission may not exceed 13 dB.

#### 3.6.2 TEST PROCEDURES

The testing follows FCC KDB 971168 v03r01 Section 5.7.

1. Set resolution/measurement bandwidth  $\geq$  signal's occupied bandwidth;
2. Set the number of counts to a value that stabilizes the measured CCDF curve;
3. Record the maximum PAPR level associated with a probability of 0.1%.

#### 3.6.3 TEST SETUP LAYOUT

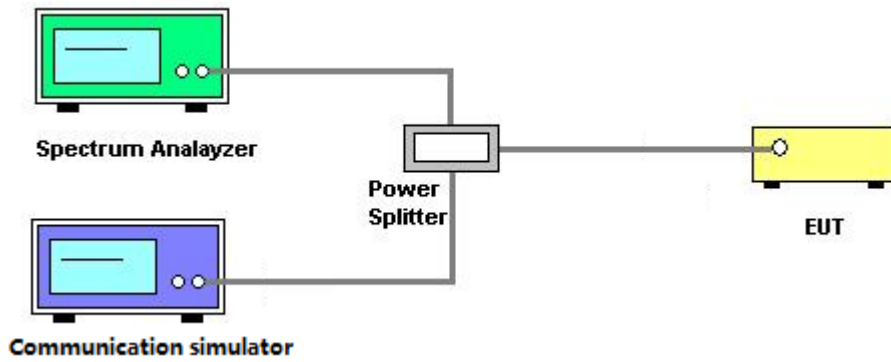

#### 3.6.4 TEST DEVIATION

No deviation

#### 3.6.5 TEST RESULTS

Please refer to the APPENDIX H.

### 3.7 FREQUENCY STABILITY MEASUREMENT

#### 3.7.1 LIMIT

$\pm 1.5$  ppm is for base and fixed station.  $\pm 2.5$  ppm is for mobile station.

#### 3.7.2 TEST PROCEDURES

The testing follows FCC KDB 971168 v03r01 Section 9.

1. Device is placed at the oven room. The oven room could control the temperatures and humidity. Power warm up is at least 15 min and power applied should perform before recording frequency error.
2. EUT is connected the external power supply to control the DC input power. The test voltage range is from minimum to maximum working voltage. Each step shall be record the frequency error rate.
3. The temperature range step is 10 degrees in this test items. All temperature levels shall be hold the  $\pm 0.5^{\circ}\text{C}$  during the measurement testing. The each temperature step shall be at least 0.5 hours, consider the EUT could be test under the stability condition.
4. The frequency error was recorded frequency error from the communication simulator.

#### 3.7.3 TEST SETUP LAYOUT

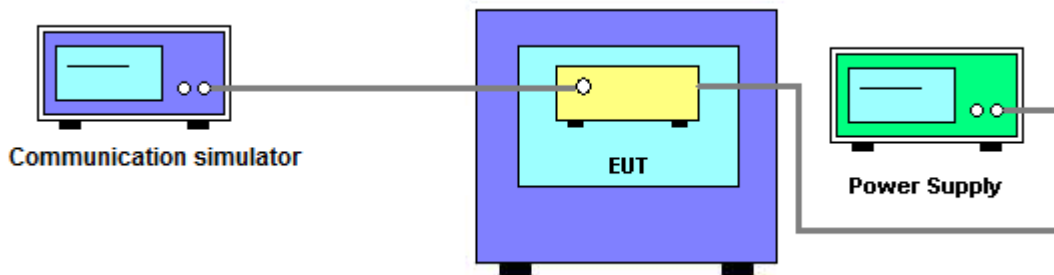

#### 3.7.4 TEST DEVIATION

No deviation

#### 3.7.5 TEST RESULTS

Please refer to the APPENDIX I.

#### 4. LIST OF MEASUREMENT EQUIPMENTS

Radiated Emissions - 9 kHz to 30 MHz					
Item	Kind of Equipment	Manufacturer	Type No.	Serial No.	Calibrated until
1	MXE EMI Receiver	Keysight	N9038A	MY56400091	Feb. 27, 2022
2*	Active Loop Antenna	R&S	HFH2-Z2	830749/020	Aug. 23, 2024
3	Cable	N/A	RG 213/U (9kHz~1GHz)	N/A	May 27, 2022
4	Measurement Software	Farad	EZ-EMC Ver.NB-03A1-01	N/A	N/A
5	wideband radio communication tester	R&S	CMW500	152372	Feb. 27, 2022
6	Wireless Communication Test SET	Agilent	E5515C	MY48364183	Feb. 28, 2022
7	966 Chamber Room	ETS	9*6*6	N/A	Jul. 17, 2022

Radiated Emissions - 30 MHz to 1 GHz					
Item	Kind of Equipment	Manufacturer	Type No.	Serial No.	Calibrated until
1	Antenna	Schwarzbeck	VULB9160	9160-3232	Mar. 15, 2022
2	Amplifier	HP	8447D	2944A08742	Feb. 28, 2022
3	Cable	emci	LMR-400	N/A	May 20, 2022
4	Controller	CT	SC100	N/A	N/A
5	Controller	MF	MF-7802	MF780208416	N/A
6	Receiver	Agilent	N9038A	MY52130039	Mar. 19, 2022
7	Measurement Software	Farad	EZ-EMC Ver.NB-03A1-01	N/A	N/A
8	wideband radio communication tester	R&S	CMW500	152372	Feb. 27, 2022
9	Wireless Communication Test SET	Agilent	E5515C	MY48364183	Feb. 28, 2022
10	966 Chamber Room	RM	9*6*6	N/A	Jul. 24, 2022

Radiated Emissions - Above 1 GHz					
Item	Kind of Equipment	Manufacturer	Type No.	Serial No.	Calibrated until
1	Double Ridged Horn Antenna	ARA	DRG-118A	16554	Apr. 21, 2022
2	Broad-Band Horn Antenna	Schwarzbeck	BBHA 9170	9170319	Jun. 30, 2022
3	Amplifier	Agilent	8449B	3008A02584	Jul. 10, 2022
4	Controller	CT	SC100	N/A	N/A
5	Controller	MF	MF-7802	MF780208416	N/A
6	Receiver	Agilent	N9038A	MY52130039	Mar. 19, 2022
7	EXA Spectrum Analyzer	Keysight	N9010A	MY56480488	Feb. 28, 2022
8	Low Noise Amplifier	CONNPHY	CLN-18G40G -4330-K	619413	Jul. 16, 2022
9	Cable	N/A	A81-SMAMSMAM -12.5M	N/A	Oct. 15, 2022
10	Cable	Talent microwave	A40-2.92M2.92M -2.5M	N/A	Nov. 30, 2022
11	Filter	STI	STI15-9912	N/A	Jul. 10, 2022
12	Measurement Software	Farad	EZ-EMC Ver.NB -03A1-01	N/A	N/A
13	wideband radio communication tester	R&S	CMW500	152372	Feb. 27, 2022
14	Wireless Communication Test SET	Agilent	E5515C	MY48364183	Feb. 28, 2022
15	966 Chamber Room	RM	9*6*6	N/A	Jul. 24, 2022

Conducted Measurement					
Item	Kind of Equipment	Manufacturer	Type No.	Serial No.	Calibrated until
1	8960 Series 10 Wireless Com Test set	Agilent	E5515E	MY52112163	Jul. 24, 2022
2	MXA Signal Analyzer	Keysight	N9020A	MY49100060	Jul. 24, 2022
3	Power Splitter	Mini-Circuits	ZFRSC-183-S+	SF103501511S	Jul. 24, 2022
4	wideband radio communication tester	R&S	CMW500	104462	Jul. 24, 2022
5	Const Temp. & Humidity Chamber	Bell	BTH-50C	20170306001	Feb. 27, 2022
6*	Multi-output DC Power Supply	GW Instek	GPC-3030DN	EK880675	Jul. 25, 2023
7	Signal Analyzer	R&S	FSQ-26	200822	Feb. 27, 2022

Remark: "N/A" denotes no model name, serial no. or calibration specified.  
 Except \* item, all calibration period of equipment list is one year.  
 "\*\*" calibration period of equipment list is three year.

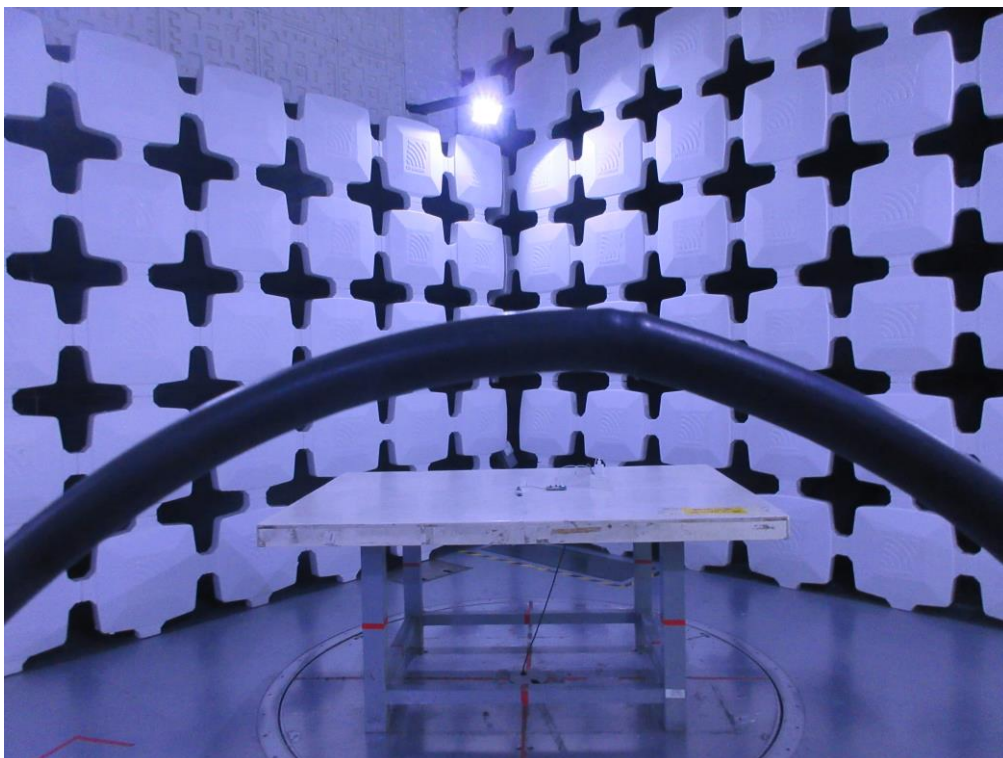
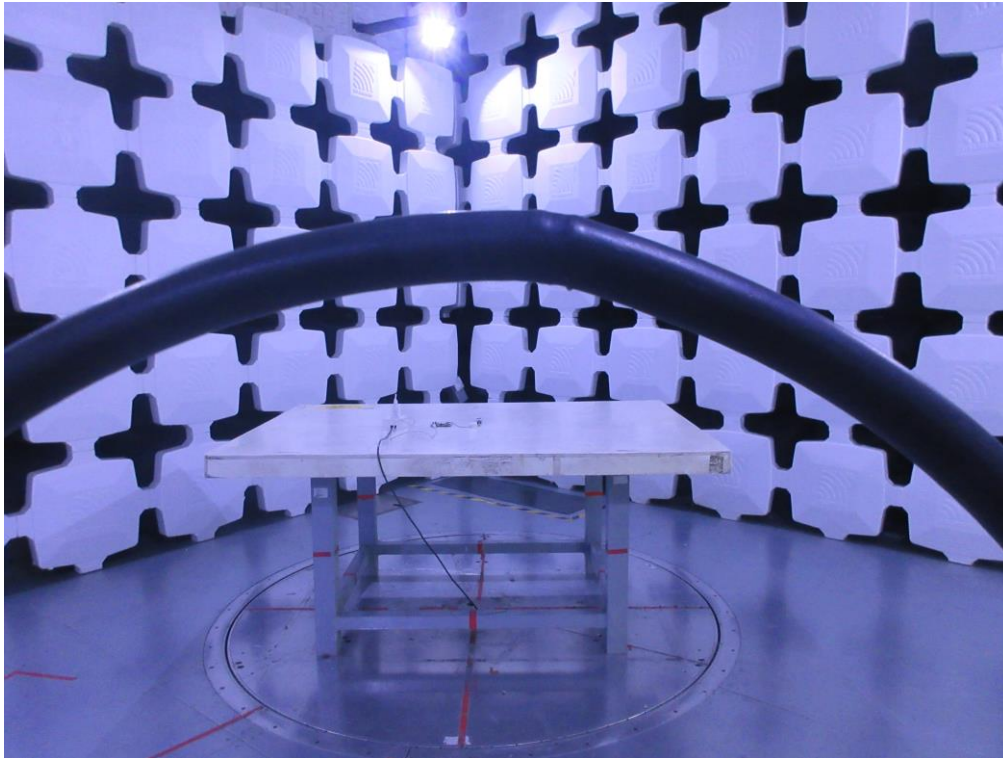

**5. EUT TEST PHOTO****Radiated Emissions Test Photos****9 kHz to 30 MHz**

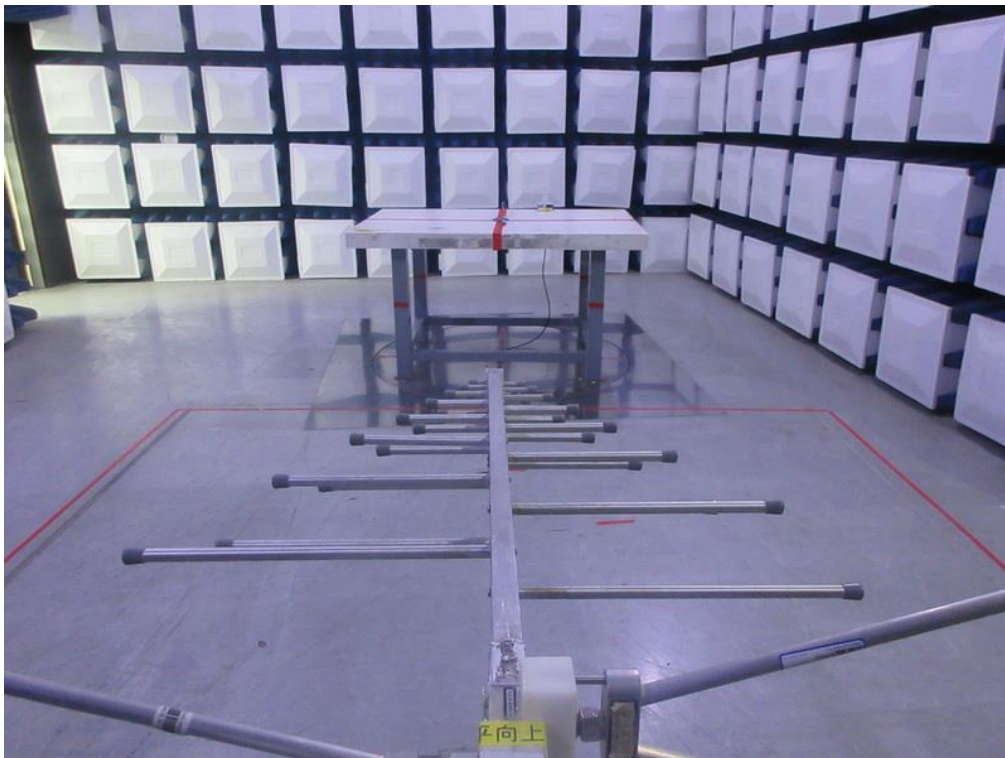
**Radiated Emissions Test Photos****30 MHz to 1 GHz**



**Radiated Emissions Test Photos****Above 1 GHz**

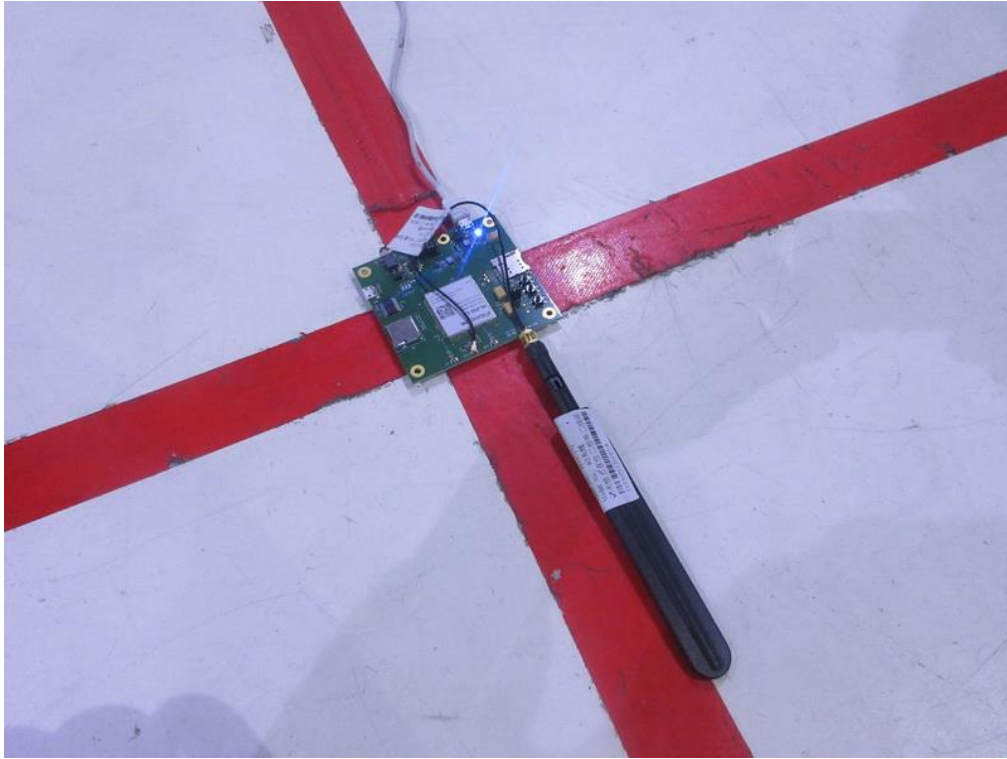

## APPENDIX A - OUTPUT POWER

**Output Power (dBm):**

GSM850		128CH	190CH	251CH
		824.2MHz	836.6MHz	848.8MHz
GSM (CS)		31.7	31.70	31.72
GPRS/EDGE (GMSK)	1 Tx Slot	31.69	31.54	31.52
	2 Tx Slot	29.17	29.05	28.81
	3 Tx Slot	27.9	27.79	27.70
	4 Tx Slot	26.63	26.69	26.60
EDGE (8PSK)	1 Tx Slot	26.37	26.00	25.66
	2 Tx Slot	26.71	26.06	26.07
	3 Tx Slot	26.38	25.69	25.73
	4 Tx Slot	25.87	25.34	25.60

Modulation	Band	WCDMA Band V		
	Tx Channel	4132CH	4182CH	4233CH
	Frequency	826.4MHz	836.4MHz	846.6MHz
QPSK	RMC 12.2K	23.52	23.57	23.78
	RMC 64K	23.52	23.58	23.75
	RMC 144K	23.53	23.59	23.78
	RMC 384K	23.49	23.58	23.75
	HSDPA Subtest-1	22.54	22.58	22.81
	HSDPA Subtest-2	22.54	22.63	22.81
	HSDPA Subtest-3	22.04	22.15	22.34
	HSDPA Subtest-4	22.12	22.15	22.32
	HSUPA Subtest-1	22.59	22.45	22.77
	HSUPA Subtest-2	21.12	21.1	21.68
	HSUPA Subtest-3	20.72	21.56	21.32
	HSUPA Subtest-4	21.65	21.63	22.13
	HSUPA Subtest-5	22.53	22.5	22.71

LTE Band / BW	Modulation	RB Size	RB Offset	Low CH	Mid CH	High CH
				20407CH	20525CH	20643CH
				824.7MHz	836.5MHz	848.3MHz
5 / 1.4MHz	QPSK	1	0	22.34	22.32	22.38
		1	2	22.72	22.62	22.35
		1	5	22.56	22.42	22.41
		3	0	22.60	22.54	22.48
		3	1	22.77	22.56	22.53
		3	2	22.47	22.49	22.62
	16QAM	6	0	21.54	21.45	21.59
		1	0	21.51	21.71	21.35
		1	2	21.37	21.78	22.09
		1	5	21.21	21.28	21.76
		3	0	21.51	21.26	21.83
		3	1	21.84	21.32	21.80
		3	2	21.68	21.51	21.68
		6	0	20.56	20.60	20.83

LTE Band / BW	Modulation	RB Size	RB Offset	Low CH	Mid CH	High CH
				20415CH	20525CH	20635CH
				825.5MHz	836.5MHz	847.5MHz
5 / 3MHz	QPSK	1	0	22.90	22.52	22.56
		1	7	22.73	22.26	22.49
		1	14	22.72	22.51	22.43
		8	0	21.72	21.60	21.73
		8	4	21.59	21.67	21.60
		8	7	21.69	21.59	21.63
		15	0	21.74	21.61	21.66
	16QAM	1	0	22.26	21.74	21.95
		1	7	22.19	21.69	21.96
		1	14	21.99	21.54	21.92
		8	0	20.97	20.59	20.54
		8	4	21.03	20.61	20.60
		8	7	21.04	20.40	20.40
		15	0	20.83	20.76	20.74

LTE Band / BW	Modulation	RB Size	RB Offset	Low CH	Mid CH	High CH
				20425CH	20525CH	20625CH
				826.5MHz	836.5MHz	846.5MHz
5 / 5MHz	QPSK	1	0	22.68	22.24	22.44
		1	13	22.75	22.31	22.59
		1	24	22.52	22.35	22.57
		12	0	21.78	21.68	21.76
		12	6	21.74	21.69	21.67
		12	11	21.77	21.63	21.66
	16QAM	25	0	21.74	21.63	21.72
		1	0	21.77	21.77	22.00
		1	13	21.77	21.47	21.51
		1	24	21.61	21.57	21.93
		12	0	20.80	20.53	20.63
		12	6	20.94	20.71	20.67
		12	11	20.77	20.41	20.61
		25	0	20.95	20.71	20.64

LTE Band / BW	Modulation	RB Size	RB Offset	Low CH	Mid CH	High CH
				20450CH	20525CH	20600CH
				829.0MHz	836.5MHz	844.0MHz
5 / 10MHz	QPSK	1	0	22.43	22.52	22.59
		1	25	22.65	22.71	22.63
		1	49	22.81	22.70	22.43
		25	0	21.69	21.67	21.75
		25	13	21.60	21.76	21.69
		25	25	21.60	21.76	21.69
		50	0	21.63	21.65	21.71
	16QAM	1	0	22.05	21.40	21.75
		1	25	22.02	20.95	21.79
		1	49	21.86	21.55	21.85
		25	0	20.78	20.66	20.71
		25	13	20.70	20.75	20.67
		25	25	20.66	20.79	20.60
		50	0	20.69	20.59	20.67



**ERP (dBm):**

GSM850		128CH	190CH	251CH
		824.2MHz	836.6MHz	848.8MHz
GSM (CS)		28.15	28.15	28.17
GPRS/EDGE (GMSK)	1 Tx Slot	28.14	27.99	27.97
	2 Tx Slot	25.62	25.50	25.26
	3 Tx Slot	24.35	24.24	24.15
	4 Tx Slot	23.08	23.14	23.05
EDGE (8PSK)	1 Tx Slot	22.82	22.45	22.11
	2 Tx Slot	23.16	22.51	22.52
	3 Tx Slot	22.83	22.14	22.18
	4 Tx Slot	22.32	21.79	22.05

Modulation	Band	WCDMA Band V		
	Tx Channel	4132CH	4182CH	4233CH
	Frequency	826.4MHz	836.4MHz	846.6MHz
QPSK	RMC 12.2K	19.97	20.02	20.23
	RMC 64K	19.97	20.03	20.20
	RMC 144K	19.98	20.04	20.23
	RMC 384K	19.94	20.03	20.20
	HSDPA Subtest-1	18.99	19.03	19.26
	HSDPA Subtest-2	18.99	19.08	19.26
	HSDPA Subtest-3	18.49	18.60	18.79
	HSDPA Subtest-4	18.57	18.60	18.77
	HSUPA Subtest-1	19.04	18.90	19.22
	HSUPA Subtest-2	17.57	17.55	18.13
	HSUPA Subtest-3	17.17	18.01	17.77
	HSUPA Subtest-4	18.10	18.08	18.58
	HSUPA Subtest-5	18.98	18.95	19.16

LTE Band / BW	Modulation	RB Size	RB Offset	Low CH	Mid CH	High CH
				20407CH	20525CH	20643CH
				824.7MHz	836.5MHz	848.3MHz
5 / 1.4MHz	QPSK	1	0	18.79	18.77	18.83
		1	2	19.17	19.07	18.80
		1	5	19.01	18.87	18.86
		3	0	19.05	18.99	18.93
		3	1	19.22	19.01	18.98
		3	2	18.92	18.94	19.07
	16QAM	6	0	17.99	17.90	18.04
		1	0	17.96	18.16	17.80
		1	2	17.82	18.23	18.54
		1	5	17.66	17.73	18.21
		3	0	17.96	17.71	18.28
		3	1	18.29	17.77	18.25
		3	2	18.13	17.96	18.13
		6	0	17.01	17.05	17.28

LTE Band / BW	Modulation	RB Size	RB Offset	Low CH	Mid CH	High CH
				20415CH	20525CH	20635CH
				825.5MHz	836.5MHz	847.5MHz
5 / 3MHz	QPSK	1	0	19.35	18.97	19.01
		1	7	19.18	18.71	18.94
		1	14	19.17	18.96	18.88
		8	0	18.17	18.05	18.18
		8	4	18.04	18.12	18.05
		8	7	18.14	18.04	18.08
		15	0	18.19	18.06	18.11
	16QAM	1	0	18.71	18.19	18.40
		1	7	18.64	18.14	18.41
		1	14	18.44	17.99	18.37
		8	0	17.42	17.04	16.99
		8	4	17.48	17.06	17.05
		8	7	17.49	16.85	16.85
		15	0	17.28	17.21	17.19

LTE Band / BW	Modulation	RB Size	RB Offset	Low CH	Mid CH	High CH
				20425CH	20525CH	20625CH
				826.5MHz	836.5MHz	846.5MHz
5 / 5MHz	QPSK	1	0	19.13	18.69	18.89
		1	13	19.20	18.76	19.04
		1	24	18.97	18.80	19.02
		12	0	18.23	18.13	18.21
		12	6	18.19	18.14	18.12
		12	11	18.22	18.08	18.11
	16QAM	25	0	18.19	18.08	18.17
		1	0	18.22	18.22	18.45
		1	13	18.22	17.92	17.96
		1	24	18.06	18.02	18.38
		12	0	17.25	16.98	17.08
		12	6	17.39	17.16	17.12
		12	11	17.22	16.86	17.06
		25	0	17.40	17.16	17.09

LTE Band / BW	Modulation	RB Size	RB Offset	Low CH	Mid CH	High CH
				20450CH	20525CH	20600CH
				829.0MHz	836.5MHz	844.0MHz
5 / 10MHz	QPSK	1	0	18.88	18.97	19.04
		1	25	19.10	19.16	19.08
		1	49	19.26	19.15	18.88
		25	0	18.14	18.12	18.20
		25	13	18.05	18.21	18.14
		25	25	18.05	18.21	18.14
	16QAM	50	0	18.08	18.10	18.16
		1	0	18.50	17.85	18.20
		1	25	18.47	17.40	18.24
		1	49	18.31	18.00	18.30
		25	0	17.23	17.11	17.16
		25	13	17.15	17.20	17.12
		25	25	17.11	17.24	17.05
		50	0	17.14	17.04	17.12

## APPENDIX B - OCCUPIED BANDWIDTH

GSM850_GSM			
Channel	Frequency (MHz)	99% Occupied Bandwidth (MHz)	26dB Bandwidth (MHz)
		QPSK	QPSK
128	824.2	0.2388	0.3025
190	836.6	0.2390	0.3019
251	848.8	0.2390	0.3030

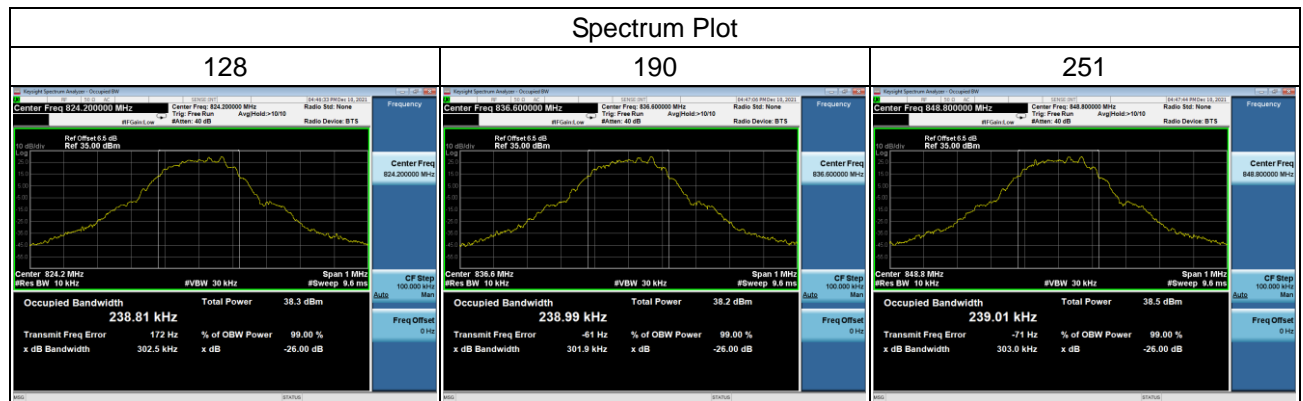

GSM850_EDGE			
Channel	Frequency (MHz)	99% Occupied Bandwidth (MHz)	26dB Bandwidth (MHz)
		QPSK	QPSK
128	824.2	0.2455	0.3154
190	836.6	0.2407	0.3118
251	848.8	0.2450	0.3164

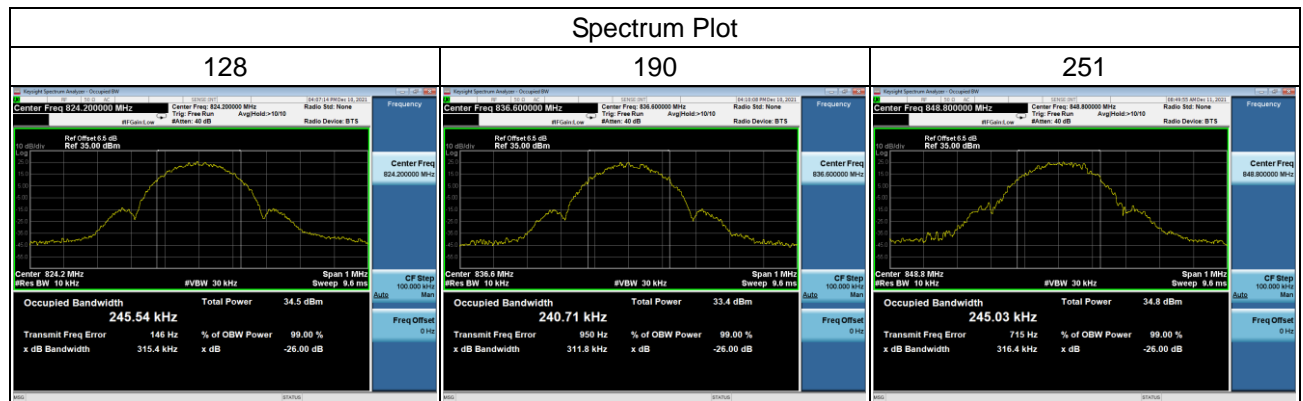

WCDMA Band V_WCDMA			
Channel	Frequency (MHz)	99% Occupied Bandwidth (MHz)	26dB Bandwidth (MHz)
		QPSK	QPSK
4132	826.4	4.1545	4.760
4182	836.4	4.1645	4.756
4233	846.6	4.1667	4.772

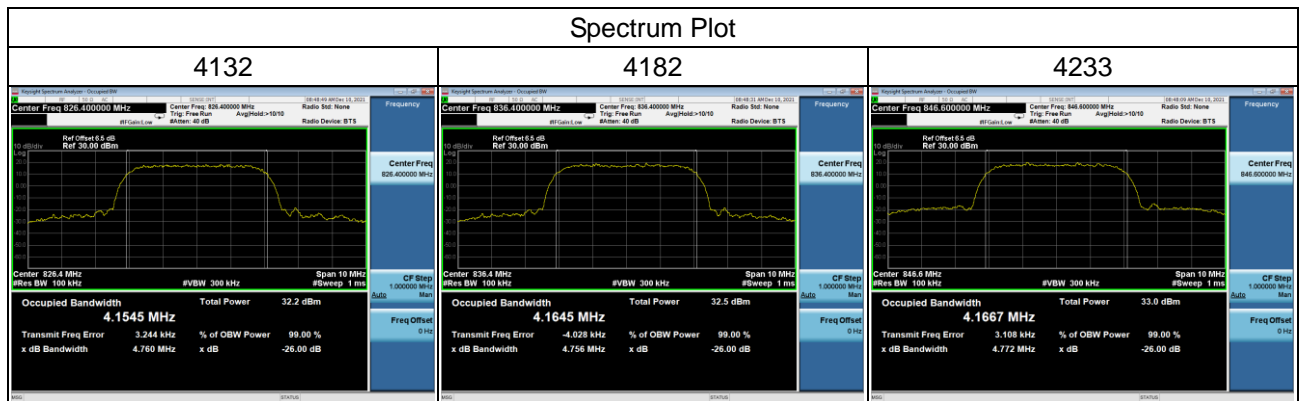

LTE Band 5_1.4MHz					
Channel	Frequency (MHz)	99% Occupied Bandwidth (MHz)		26dB Bandwidth (MHz)	
		QPSK	16QAM	QPSK	16QAM
20407	824.7	1.0886	1.0878	1.286	1.287
20525	836.5	1.0911	1.0921	1.290	1.290
20643	848.3	1.1018	1.0973	1.314	1.303

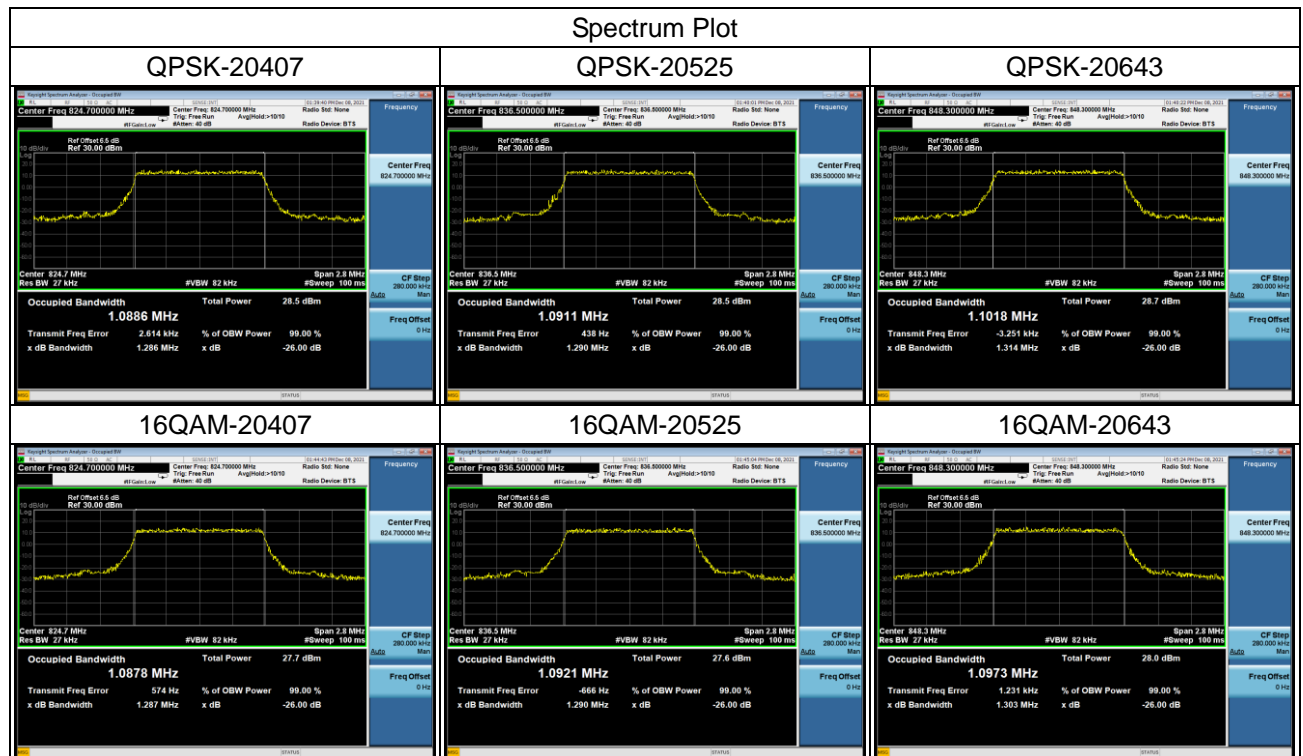



LTE Band 5_3MHz					
Channel	Frequency (MHz)	99% Occupied Bandwidth (MHz)		26dB Bandwidth (MHz)	
		QPSK	16QAM	QPSK	16QAM
20415	825.5	2.6968	2.6979	2.990	2.972
20525	836.5	2.7026	2.6996	2.988	2.979
20635	847.5	2.6954	2.6969	2.986	3.002

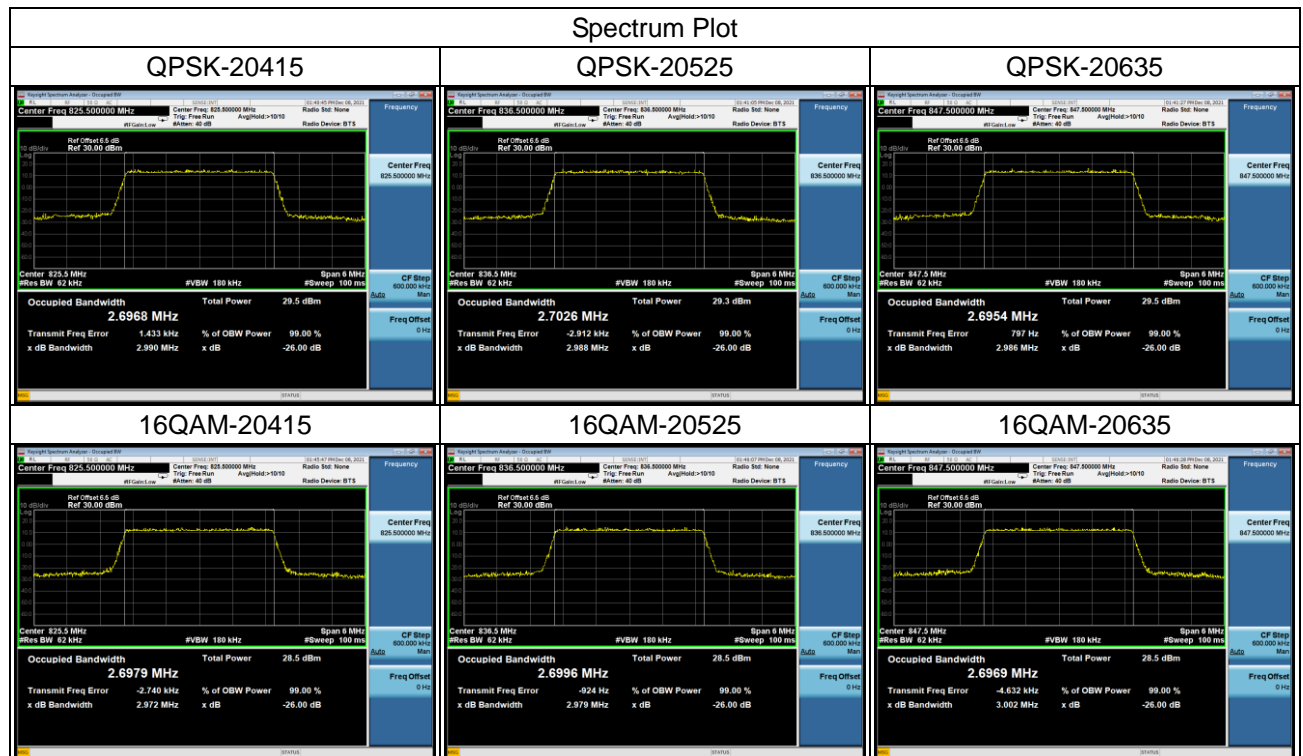

LTE Band 5_5MHz					
Channel	Frequency (MHz)	99% Occupied Bandwidth (MHz)		26dB Bandwidth (MHz)	
		QPSK	16QAM	QPSK	16QAM
20425	826.5	4.5061	4.5028	5.020	5.027
20525	836.5	4.5076	4.4954	4.948	5.001
20625	846.5	4.5070	4.4976	5.003	4.966

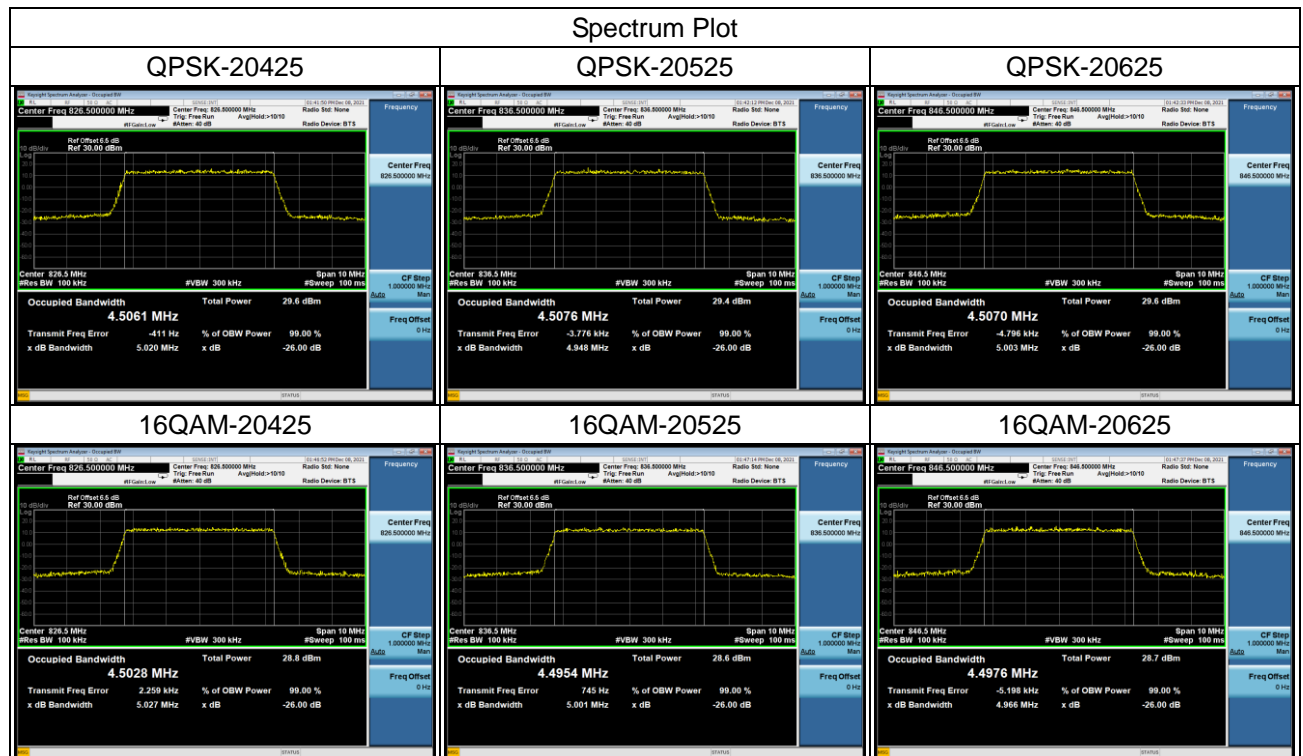

LTE Band 5_10MHz					
Channel	Frequency (MHz)	99% Occupied Bandwidth (MHz)		26dB Bandwidth (MHz)	
		QPSK	16QAM	QPSK	16QAM
20450	829.0	8.9578	8.9403	9.968	9.788
20525	836.5	8.9527	8.9536	9.896	9.907
20600	844.0	8.9512	8.9565	9.900	9.822

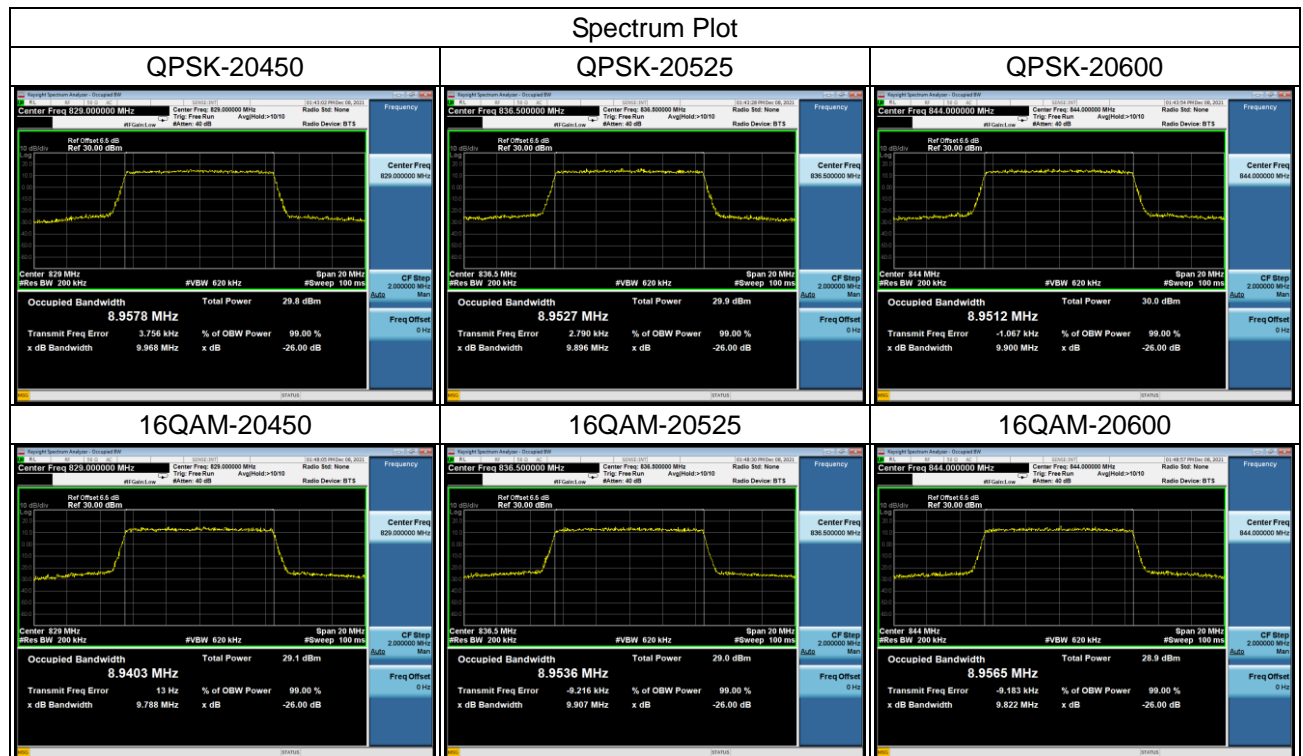

## **APPENDIX C - CONDUCTED SPURIOUS EMISSIONS**

## GSM850\_GSM\_CH190 Spectrum Plot

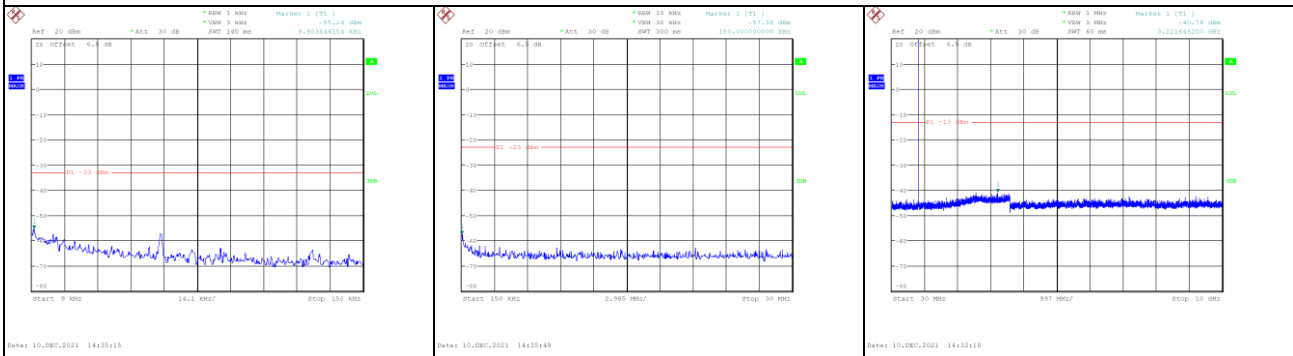

## GSM850\_EDGE\_CH190 Spectrum Plot

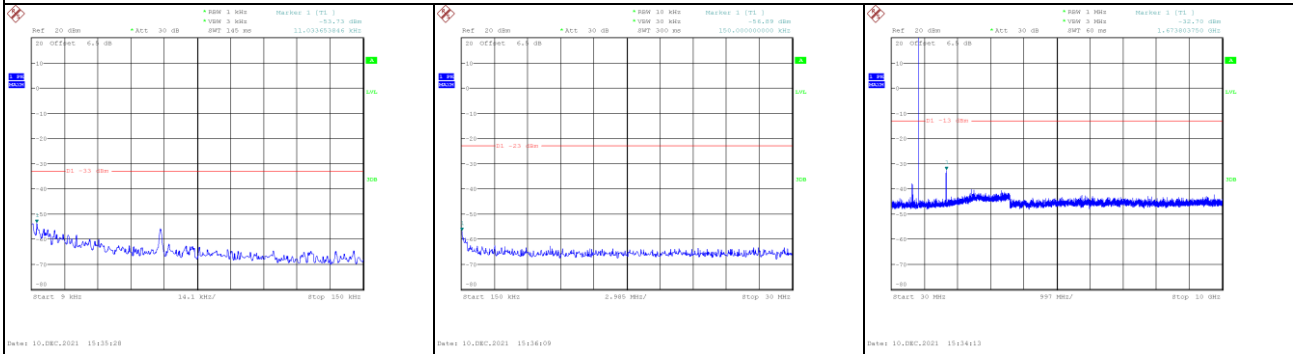

### WCDMA Band V\_WCDMA\_CH4182 Spectrum Plot

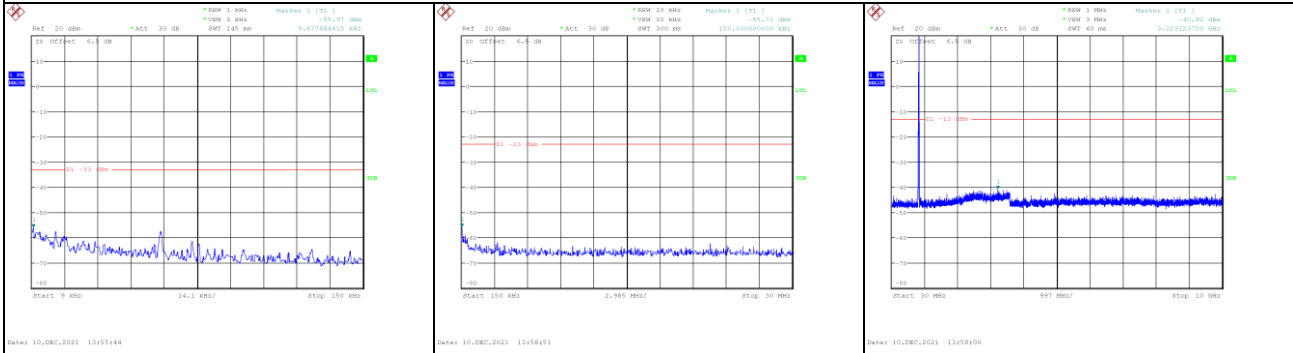

## LTE Band 5\_1.4MHz\_CH20525 Spectrum Plot

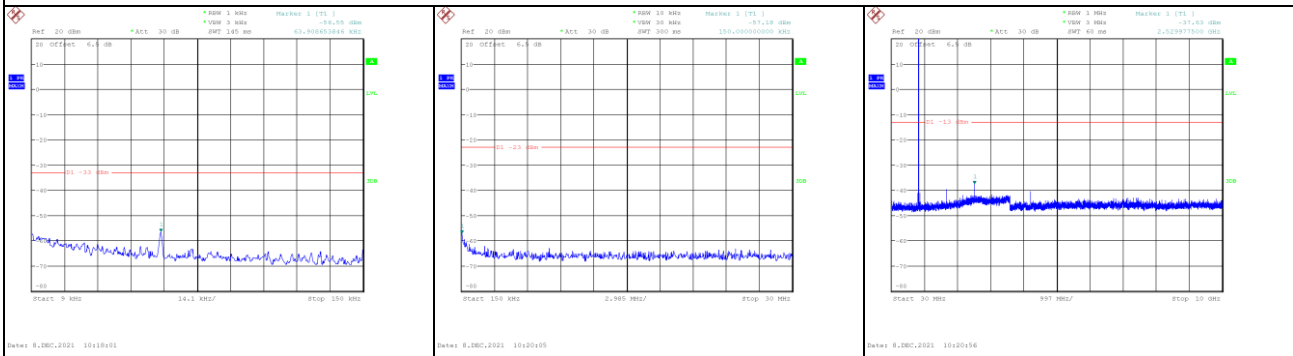

## LTE Band 5\_5MHz\_CH20525 Spectrum Plot

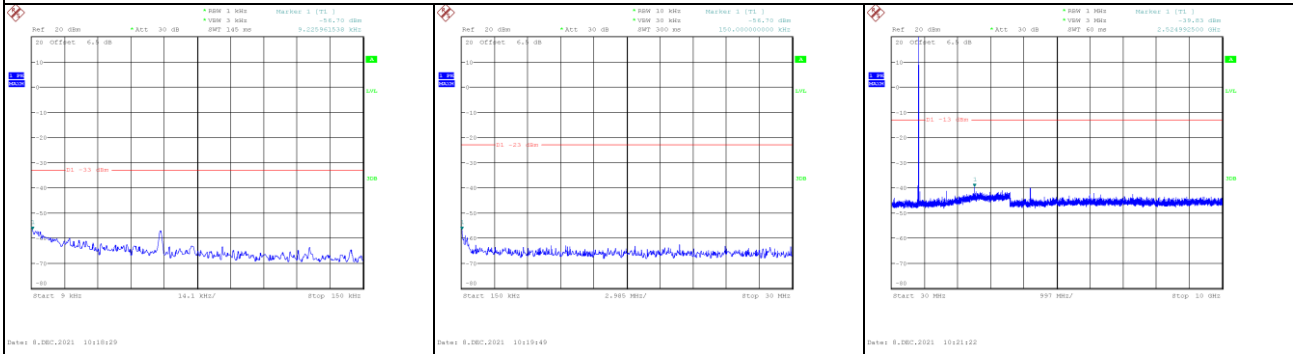

## LTE Band 5\_10MHz\_CH20525 Spectrum Plot

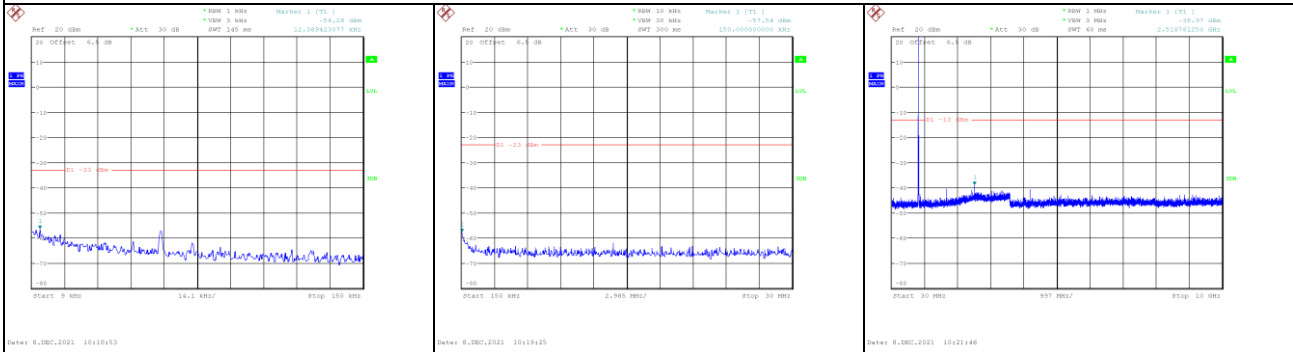

## **APPENDIX D - RADIATED SPURIOUS EMISSIONS (9KHZ TO 30MHZ)**



Test Mode : TX Mode

Ant 0°

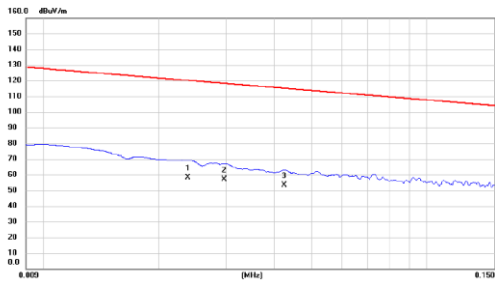

No. Mk.	Freq.	Reading Level	Correct Factor	Measurement	Limit	Margin	Antenna Height	Table Degree	Comment
	MHz	dBuV	dB	dBuV/m	dBuV/m	dB	cm	degree	
1	0.0238	45.36	13.00	58.36	120.07	-61.71		AVG	
2 *	0.0296	44.26	12.84	57.10	118.18	-61.08		AVG	
3	0.0424	40.82	12.50	53.32	115.06	-61.74		AVG	

Test Mode : TX Mode

Ant 0°



No. Mk.	Freq.	Reading Level	Correct Factor	Measurement	Limit	Margin	Antenna Height	Table Degree	Comment
	MHz	dBuV	dB	dBuV/m	dBuV/m	dB	cm	degree	
1	0.4485	30.85	11.93	42.78	94.57	-51.79		AVG	
2 *	2.0664	37.25	11.11	48.36	69.54	-21.18		QP	
3	2.7470	29.36	10.71	40.07	69.54	-29.47		QP	

Test Mode : TX Mode

Ant 90°

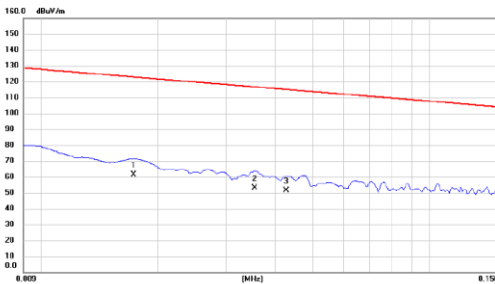

No. Mk.	Freq.	Reading Level	Correct Factor	Measurement	Limit	Margin	Antenna Height	Table Degree	Comment
	MHz	dBuV	dB	dBuV/m	dBuV/m	dB	cm	degree	
1 *	0.0173	47.39	13.94	61.33	122.84	-61.51		AVG	
2	0.0355	40.38	12.69	53.07	116.60	-63.53		AVG	
3	0.0427	38.96	12.49	51.45	115.00	-63.55		AVG	

Test Mode : TX Mode

Ant 90°

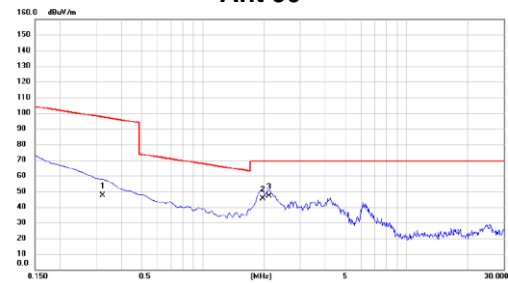

No. Mk.	Freq.	Reading Level	Correct Factor	Measurement	Limit	Margin	Antenna Height	Table Degree	Comment
	MHz	dBuV	dB	dBuV/m	dBuV/m	dB	cm	degree	
1	0.3234	35.24	12.30	47.54	97.41	-49.87		AVG	
2	1.9708	34.28	11.17	45.45	69.54	-24.09		QP	
3 *	2.1201	35.94	11.08	47.02	69.54	-22.52		QP	

## **APPENDIX E - RADIATED SPURIOUS EMISSIONS (30MHZ TO 1000MHZ)**

Test Mode : GSM850\_TX CH190\_GSM

Test Mode : GSM850\_TX CH190\_GSM

### Vertical

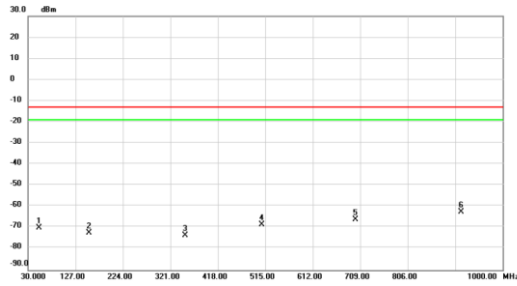

No. Mk.	Freq. MHz	Reading Level dBm	Correct Factor dB	Measurement dBm	Limit dBm	Margin dB	Detector	Comment
1	52.3100	-58.53	-11.61	-70.14	-13.00	-57.14	peak	
2	155.1300	-60.69	-11.67	-72.36	-13.00	-59.36	peak	
3	351.5550	-63.48	-10.19	-73.67	-13.00	-60.67	peak	
4	508.2100	-61.87	-6.77	-68.64	-13.00	-55.64	peak	
5	698.8150	-63.19	-2.89	-66.08	-13.00	-53.08	peak	
6 *	915.1250	-61.79	-0.76	-62.55	-13.00	-49.55	peak	

### Horizontal

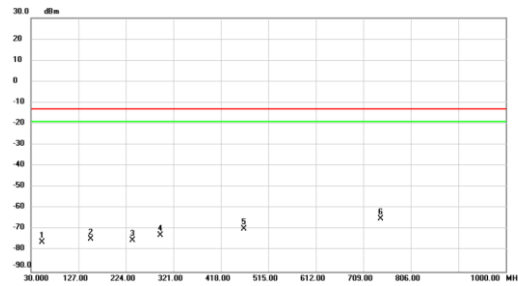

No. Mk.	Freq. MHz	Reading Level dBm	Correct Factor dB	Measurement dBm	Limit dBm	Margin dB	Detector	Comment
1	52.7950	-64.35	-11.62	-75.97	-13.00	-62.97	peak	
2	152.2200	-62.82	-11.69	-74.51	-13.00	-61.51	peak	
3	238.0650	-61.73	-13.51	-75.24	-13.00	-62.24	peak	
4	294.8100	-61.24	-11.46	-72.70	-13.00	-59.70	peak	
5	465.0450	-62.43	-7.39	-69.82	-13.00	-56.82	peak	
6 *	743.9200	-62.76	-2.21	-64.97	-13.00	-51.97	peak	

Test Mode : WCDMA Band V\_TX CH4182

Test Mode : WCDMA Band V\_TX CH4182

### Vertical

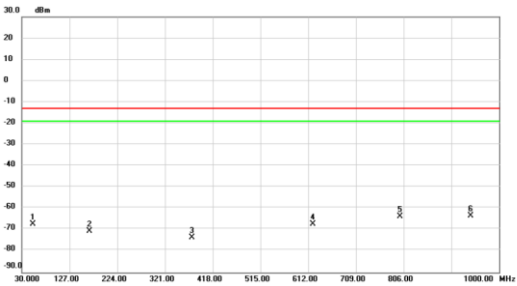

No. Mk.	Freq. MHz	Reading Level dBm	Correct Factor dB	Measurement dBm	Limit dBm	Margin dB	Detector	Comment
1	52.3100	-55.73	-11.61	-67.34	-13.00	-54.34	peak	
2	168.2250	-58.52	-11.99	-70.51	-13.00	-57.51	peak	
3	376.2900	-63.88	-9.63	-73.51	-13.00	-60.51	peak	
4	622.1850	-63.31	-4.16	-67.47	-13.00	-54.47	peak	
5	798.7250	-61.97	-1.73	-63.70	-13.00	-50.70	peak	
6 *	942.7700	-63.12	-0.30	-63.42	-13.00	-50.42	peak	

### Horizontal



No. Mk.	Freq. MHz	Reading Level dBm	Correct Factor dB	Measurement dBm	Limit dBm	Margin dB	Detector	Comment
1	47.4600	-65.20	-11.61	-76.81	-13.00	-63.81	peak	
2	158.5250	-60.99	-11.65	-72.64	-13.00	-59.64	peak	
3	244.8550	-61.18	-13.18	-74.36	-13.00	-61.36	peak	
4	419.4550	-62.42	-8.53	-70.95	-13.00	-57.95	peak	
5	672.1400	-61.17	-3.44	-64.61	-13.00	-51.61	peak	
6 *	903.4850	-62.09	-0.94	-63.03	-13.00	-50.03	peak	

Test Mode : LTE Band 5\_TX CH20525\_1.4MHz

Test Mode : LTE Band 5\_TX CH20525\_1.4MHz

### Vertical

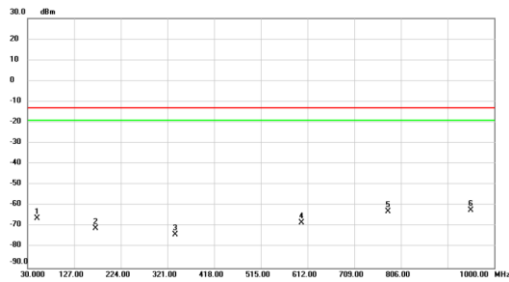

No.	Mk.	Freq. MHz	Reading Level dBm	Correct Factor dB	Measurement dBm	Limit dBm	Margin dB	Detector	Comment
1		49.8850	-64.33	-1.93	-66.26	-13.00	-53.26	peak	
2		171.6200	-68.32	-2.64	-70.96	-13.00	-57.96	peak	
3		337.4900	-73.33	-0.75	-74.08	-13.00	-61.08	peak	
4		599.8750	-73.53	5.23	-68.30	-13.00	-55.30	peak	
5		779.8100	-70.70	7.71	-62.99	-13.00	-49.99	peak	
6	*	951.5000	-71.53	9.41	-62.12	-13.00	-49.12	peak	

### Horizontal

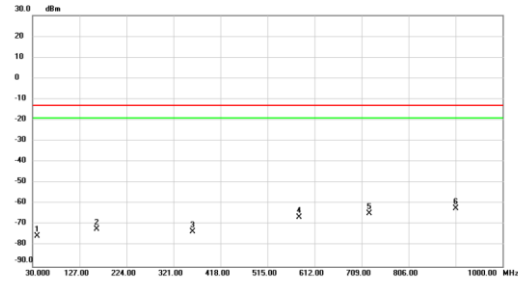

No.	Mk.	Freq. MHz	Reading Level dBm	Correct Factor dB	Measurement dBm	Limit dBm	Margin dB	Detector	Comment
1		39.7000	-73.01	-2.59	-75.60	-13.00	-62.60	peak	
2		162.8900	-69.82	-2.18	-72.00	-13.00	-59.00	peak	
3		360.2850	-72.74	-0.51	-73.25	-13.00	-60.25	peak	
4		579.9900	-71.13	4.56	-66.57	-13.00	-53.57	peak	
5		725.0050	-71.60	7.10	-64.50	-13.00	-51.50	peak	
6	*	903.9700	-70.90	8.66	-62.24	-13.00	-49.24	peak	

Test Mode : LTE Band 5\_TX CH20525\_5MHz

Test Mode : LTE Band 5\_TX CH20525\_5MHz

### Vertical

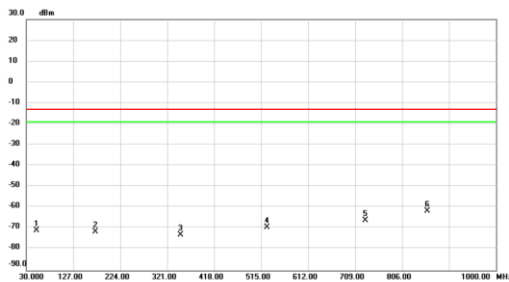

No.	Mk.	Freq. MHz	Reading Level dBm	Correct Factor dB	Measurement dBm	Limit dBm	Margin dB	Detector	Comment
1		51.8250	-68.94	-2.00	-70.94	-13.00	-57.94	peak	
2		173.0750	-68.73	-2.79	-71.52	-13.00	-58.52	peak	
3		348.6450	-72.29	-0.62	-72.91	-13.00	-59.91	peak	
4		527.6100	-72.63	3.17	-69.46	-13.00	-56.46	peak	
5		730.8250	-73.32	7.18	-66.14	-13.00	-53.14	peak	
6	*	857.8950	-70.38	8.63	-61.75	-13.00	-48.75	peak	

### Horizontal

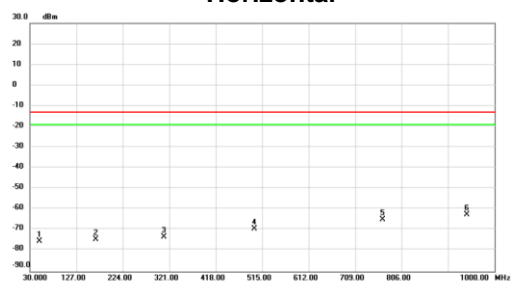

No.	Mk.	Freq. MHz	Reading Level dBm	Correct Factor dB	Measurement dBm	Limit dBm	Margin dB	Detector	Comment
1		50.3700	-73.51	-1.94	-75.45	-13.00	-62.45	peak	
2		168.2250	-72.29	-2.40	-74.69	-13.00	-61.69	peak	
3		310.3300	-72.02	-1.43	-73.45	-13.00	-60.45	peak	
4		498.9950	-72.06	2.66	-69.40	-13.00	-56.40	peak	
5		766.2300	-72.71	7.61	-65.10	-13.00	-52.10	peak	
6	*	941.8000	-71.95	9.27	-62.68	-13.00	-49.68	peak	

Test Mode : LTE Band 5\_TX CH20525\_10MHz

Test Mode : LTE Band 5\_TX CH20525\_10MHz

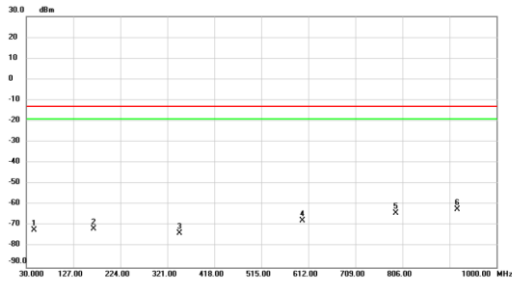
**Vertical**

No. Mk.	Freq. MHz	Reading Level dBm	Correct Factor dB	Measurement dBm	Limit dBm	Margin dB	Detector	Comment
1	45.5200	-69.95	-2.08	-72.03	-13.00	-59.03	peak	
2	168.7100	-69.15	-2.42	-71.57	-13.00	-58.57	peak	
3	346.2200	-73.04	-0.65	-73.69	-13.00	-60.69	peak	
4	599.3900	-73.01	5.21	-67.80	-13.00	-54.80	peak	
5	792.9050	-71.90	7.82	-64.08	-13.00	-51.08	peak	
6 *	919.4900	-71.14	8.91	-62.23	-13.00	-49.23	peak	

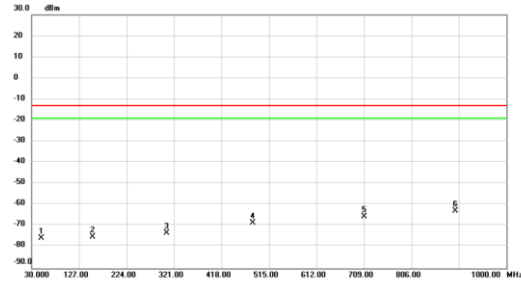
**Horizontal**

No. Mk.	Freq. MHz	Reading Level dBm	Correct Factor dB	Measurement dBm	Limit dBm	Margin dB	Detector	Comment
1	49.8850	-73.87	-1.93	-75.80	-13.00	-62.80	peak	
2	154.1600	-73.00	-2.08	-75.08	-13.00	-62.08	peak	
3	306.4500	-71.84	-1.55	-73.39	-13.00	-60.39	peak	
4	481.5350	-71.06	2.42	-68.64	-13.00	-55.64	peak	
5	709.0000	-72.47	6.85	-65.62	-13.00	-52.62	peak	
6 *	896.2100	-71.30	8.60	-62.70	-13.00	-49.70	peak	

## **APPENDIX F - RADIATED SPURIOUS EMISSIONS (ABOVE 1000MHZ)**

Test Mode : GSM850\_TX CH190\_GSM

Test Mode : GSM850\_TX CH190\_GSM

**Vertical**

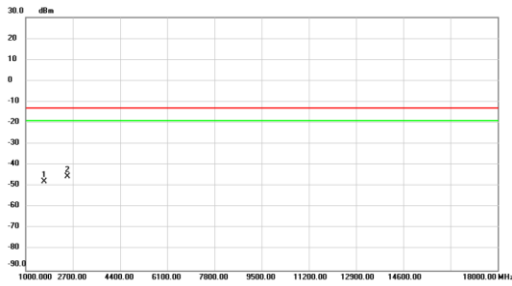

No. Mk.	Freq. MHz	Reading Level dBm	Correct Factor dB	Measurement dBm	Limit dBm	Margin dB	Detector	Comment
1	1671.500	-41.43	-6.33	-47.76	-13.00	-34.76	peak	
2 *	2513.000	-41.28	-4.25	-45.53	-13.00	-32.53	peak	

**Horizontal**

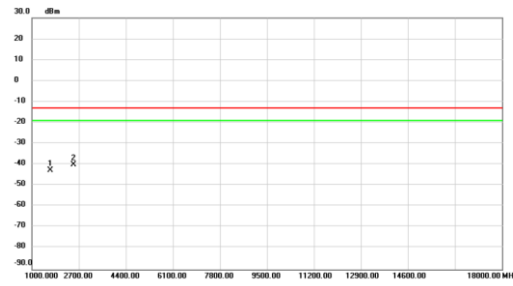

No. Mk.	Freq. MHz	Reading Level dBm	Correct Factor dB	Measurement dBm	Limit dBm	Margin dB	Detector	Comment
1	1671.500	-36.54	-8.33	-42.87	-13.00	-29.87	peak	
2 *	2513.000	-35.68	-4.25	-39.93	-13.00	-26.93	peak	

Test Mode : WCDMA Band V\_TX CH4182

Test Mode : WCDMA Band V\_TX CH4182

**Vertical**

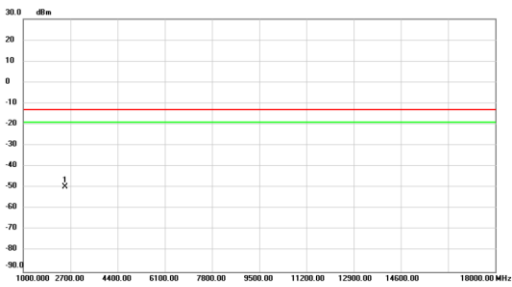

No. Mk.	Freq. MHz	Reading Level dBm	Correct Factor dB	Measurement dBm	Limit dBm	Margin dB	Detector	Comment
1 *	2504.500	-45.26	-4.27	-49.53	-13.00	-36.53	peak	

**Horizontal**

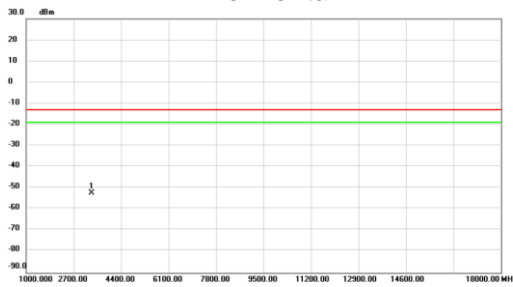

No. Mk.	Freq. MHz	Reading Level dBm	Correct Factor dB	Measurement dBm	Limit dBm	Margin dB	Detector	Comment
1 *	3354.500	-49.99	-2.25	-52.24	-13.00	-39.24	peak	