

# 2 inch Label Printer

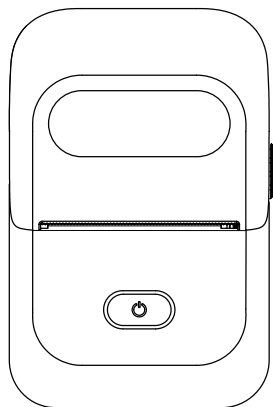

USER MANUAL

## Product Guidelines

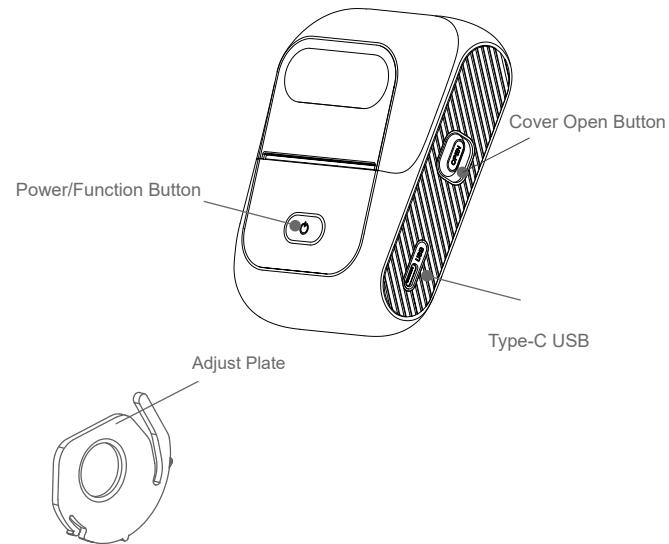

Remarks: Users should use a power adapter international recognized and meets standard requirements.

## Product Parameters

Print Method	Thermal Printing
Dimension	130x82x60.5mm
Weight	303 g
Label Width	Up to 57mm
Battery Capacity	1500mAh x 7.4V
Resolution	203DPI
Display Type	RGB LED
Operating Temperature	0°C ~ 45°C
Charge Mode	Type-C 5V USB

## Basic Usage

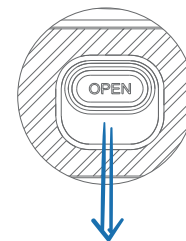

1. Push down the button to open the cover.

2. Put the label into the paper compartment as shown in the figure, keep the printable side down.

Put the adjust plate into the correct slot to fix the label.

Then close the top cover to ensure that it is closed tightly.

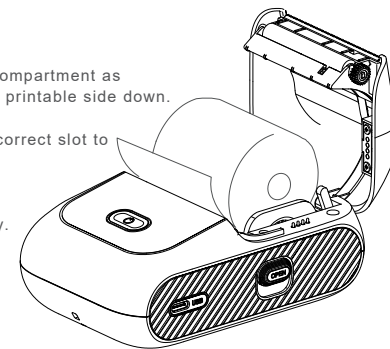

3. Press and hold the power button to power on.

4. Turn on the phone's bluetooth, scan the QR code on the box to download label editing APP, then connect with printer on the APP.

5. Edit the print content, and confirm the printing.

## Description of Status Light

Light Color	State	Description
Green	Breathing light	Bluetooth is not connected
Green	Always on	Bluetooth is connected
Multicolor	Mixed flash	Label is printing
Red	Strobe	Low voltage battery
Red	Breathing light	Recharging
Yellow	Always on	Out of paper/Top cover is open
Yellow	Strobe	Do not match the label

## Fault Diagnosis

### 1.Fail to feed paper by pressing function button after label paper installation.

Please confirm the label paper is installed with printable side down.

Please confirm label feed out part is in the position of print head rubber roller.

If not, please pull out part of the label paper by manually and close the printer top cover tightly.

### 2.Fail to print

Please confirm mobile phone bluetooth turns on and connects with printer successfully.

Please confirm you use the right APP.

Please check whether label paper has run out.







Please contact customer service if this phenomenon still exists.

### 3.Printer prints blurry

Please confirm the print darkness in printer settings, generally, default value 6 has best printing effect.

If lines or planes are not printed, please confirm whether there is foreign matter in the print head, and clean the print head with alcohol cotton.

## Warnings

-  Please confirm printer paper compartment is clean before using, it may cause damage to the print head during printing process if there is foreign matter in it. If foreign matter is found, please use special cleaner or alcohol to clean paper compartment and print head in time.
-  Please turn off the power immediately if a malfunction occurs.
-  Please do not disassemble printer by yourself, complicated circuits and devices inside it.
-  Please recharge in a cool and ventilated room. Do not expose printer and power adapter to high temperature, high humidity or put it in water, otherwise short-circuit will cause battery to heat up, emit smoke, deform, damage, or even explode. Please disconnect power when power adapter touches water or other fluid. Please remove the charger immediately when printer or charger emits smoke or smelliness, and be aware of getting scalded.
-  Please do not squeeze, shake, disassemble or refit printer and power adapter, and it is strictly forbidden to use the power adapter when the power cord is damaged, otherwise it could result in electric shock, fire, and damage to printer.
-  Please hold power adapter when unplugging it, the power cord will be damaged if pull it directly.
-  Please do not use printer near flammable materials such as gas stations, fuel warehouses, etc.

## Warranty Terms

- From the date of purchase, the print head is guaranteed for 3 months, and the remaining parts are guaranteed for 12 months.
- The warranty method is repair, user needs to send the malfunctioning product to sales service center.
- For products which have exceeded the warranty period, please contact the after-sales service center and pay for the relevant accessories.
- The warranty service cannot be enjoyed if the following conditions occur during the warranty period:  
Damage caused by accident, abuse, misuse, or use of Non-Original consumables;  
Exceeded the warranty period;  
Disassemble repair or refit the printer without authorized;  
Printing cuts off which caused by scratched print head;  
The purchase record does not match the serial number of the warranty machine;  
Damage to the machine due to human factors or other force majeure.

## FCC Statement

This device complies with Part 15 of the FCC Rules. Operation is subject to the following two conditions:

This device may not cause harmful interference, and

This device must accept any interference received, including interference that may cause undesired operation.

Warning: Changes or modifications not expressly approved by the party responsible for compliance could void the user's authority to operate the equipment.

NOTE: This equipment has been tested and found to comply with the limits for a Class B digital device, pursuant to Part 15 of the FCC Rules. These limits are designed to provide reasonable protection against harmful interference in a residential installation. This equipment generates uses and can radiate radio frequency energy and, if not installed and used in accordance with the instructions, may cause harmful interference to radio communications. However, there is no guarantee that interference will not occur in a particular installation. If this equipment does cause harmful interference to radio or television reception, which can be determined by turning the equipment off and on, the user is encouraged to try to correct the interference by one or more of the following measures:

Reorient or relocate the receiving antenna.

Increase the separation between the equipment and receiver.

Connect the equipment into an outlet on a circuit different from that to which the receiver is connected.

Consult the dealer or an experienced radio/TV technician for help.

RF warning statement:

The device has been evaluated to meet general RF exposure requirement.

The device can be used in portable exposure condition without restriction.

DETONG ELECTRONIC TRADE (SHANGHAI) CO., LTD.

Website: <https://en.detonger.com>

EMAIL: [support@dothantech.com](mailto:support@dothantech.com)

EU REP: ORIENT CONSULTING SL

ADD: AV. DE LA INDUSTRIA, 2, NV16, P.I.CANTUEÑA, FUENLABRADA,  
ESPAÑA(SPAIN)

EMAIL: [rae@orientconsulting.es](mailto:rae@orientconsulting.es) .