

User Manual

APT Model: 600C-BLE

Supplier: APT(Tianjin) Development Co., Ltd.
1001, Building 5 HuaDing, No.1 HuaKe 3
Road, Binhai hi-tech Industrial
Development Zone, Tianjin, China
TEL: 86 22 26345859
FAX: 86 22 83719955

Email yzhao@aptdevelop.com

Content

1	Product model	2
2	Suppliers	2
3	Specifications.....	2
4	Dimensions and Material	2
5	Features	3
6	Main page	3
7	Functional Description.....	5
7.1	Power On/Off	5
7.2	Assist levels	5
7.3	Screen Switching	6
7.4	Headlight / Display Mode	6
7.5	Walking mode (6km).....	6
7.6	Bluetooth	7
7.7	Data cleanup.....	9
8	Menu Page.....	9
8.1	Display settings	10
8.1.1	Language.....	10
8.1.2	System	10
8.1.3	Brightness	10
8.1.4	Auto off.....	11
8.1.5	Scenes	11
8.1.6	Clock	12
8.1.7	Focus	12
8.2	E-bike Settings	13
8.2.1	Start password.....	13
8.2.2	Assist levels	14
8.2.3	Wheelsize.....	14
8.2.4	Battery voltage.....	14
8.2.5	Battery Indexes.....	15
8.2.6	Pow Indexes.....	15
8.2.7	Pow range	16
8.3	Advanced setting.....	16
8.4	Factory Setting	17
8.5	Information	17
8.5.1	Product Infor.....	17
8.5.2	Battery Infor.....	18
9	Errors code	18
10	Assembly instructions.....	19
11	Install and use precautions.....	19
12	Copyright Notice.....	20

1 Product model

Model: 600C-BLE

2 Suppliers

APT (Tianjin) Development Co., Ltd.

3 Specifications

- 2.4inch TFT screen(IPS 240*320 pixel)
- Battery supply:24V/36V/48V/52V
- Multi-language support(6 languages)
- Maximum output current to controller: 200mA, off-leakage current <math><1\mu\text{A}</math>
- Operating temperature: $-20\sim 70^{\circ}\text{C}$, Storage temperature $-30\sim 80^{\circ}\text{C}$
- IP65
- EN 15194:2017
- RoHS

4 Dimensions and Material

Shell and bracket is made with ABS+PC, panel is high hardness acrylic.

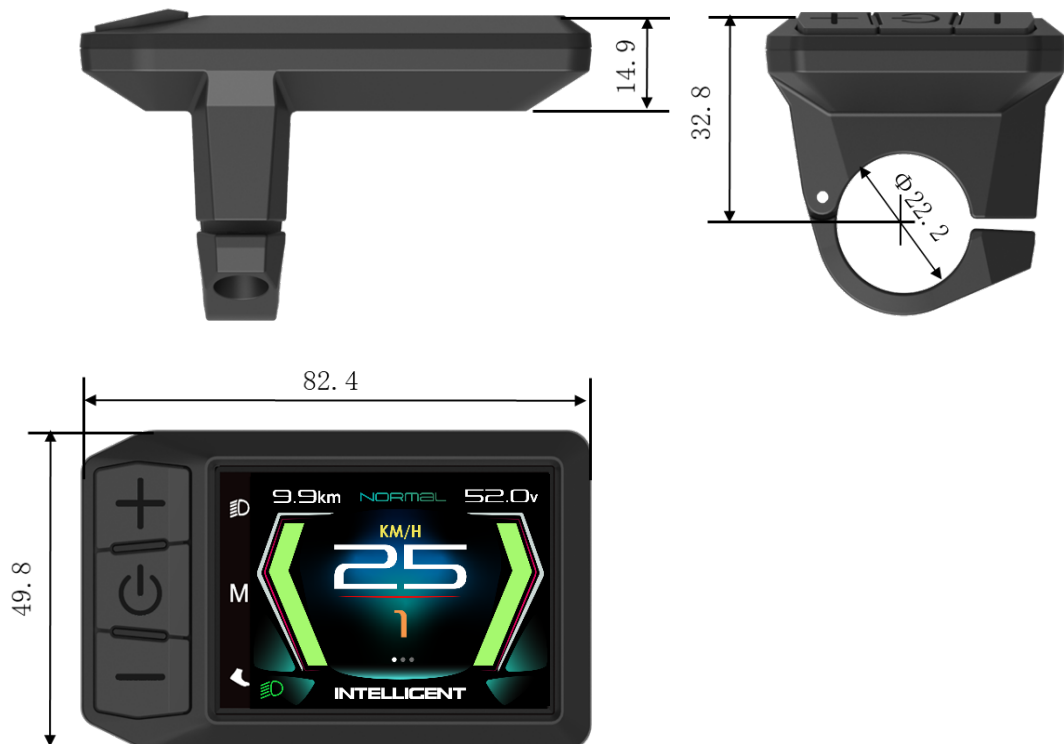

5 Features

- **2.4inch TFT screen.**
- Ergonomic external button design, easy to operate, vibration function is provided during button operation.
- **6 languages:**
Czech, German, French, English, Italian, Spanish are supported.
- **Speed indicator:** Speed (Real-time), AVG Speed, MAX Speed.
- **Metric / Imperial.**
- **Smart battery indicator:** Capacity (percentage) or Voltage.
- **Mileage / Riding time indicator:** TRIPA&TIMEA (Data reset after shutdown), TRIPB&TIMEB(Data is saved after shutdown), Odometer, Range.
- **Clock indicator:** Built in battery, clock keeps running when power off.
- **Brightness setting:** Day and Night Brightness can be set independent.
- **Assist level:** 4 modes optional (3/5/9/U).
- **Errors Code tips.**
- **6km walking.**
- **Firmware upgrade:** Upgrade the Logo individually.

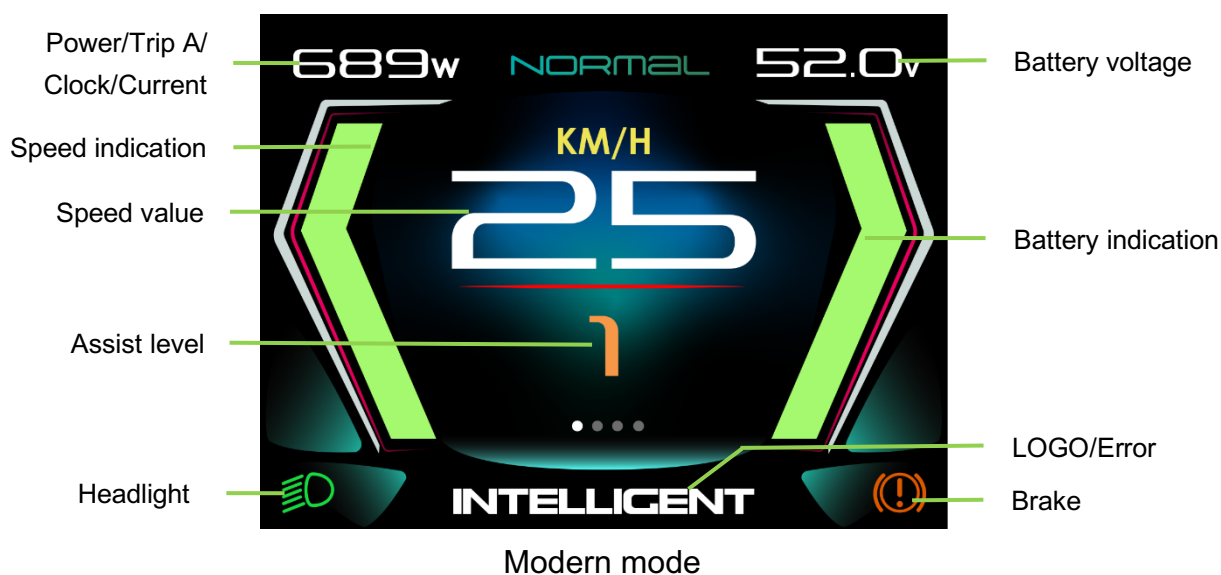

6 Main page

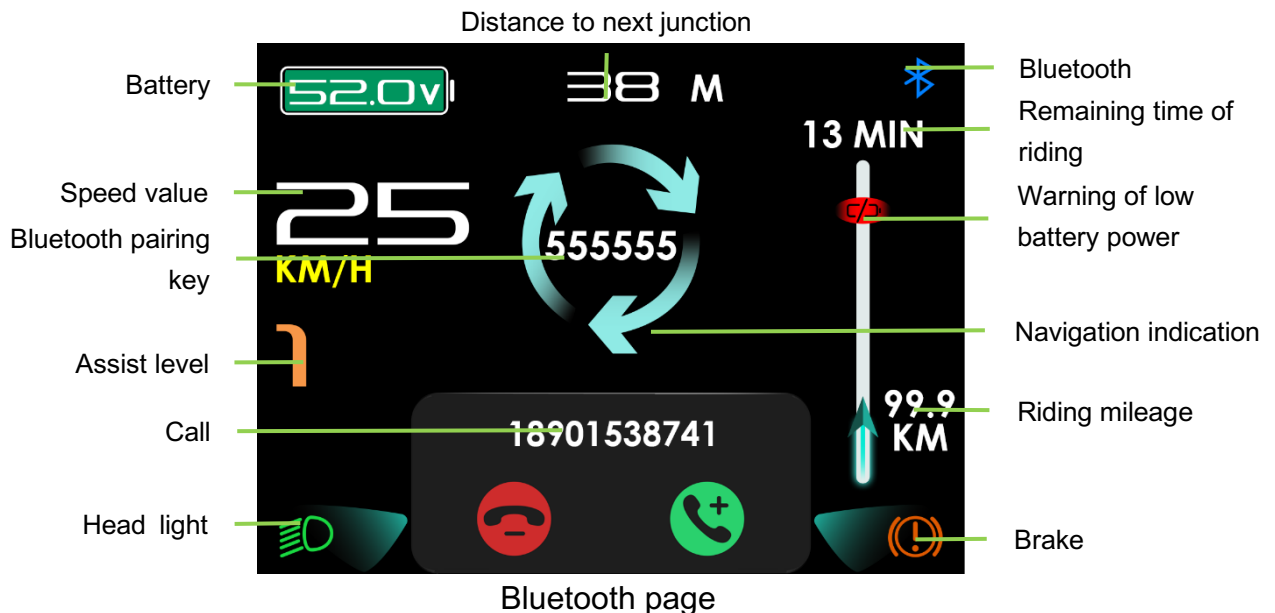
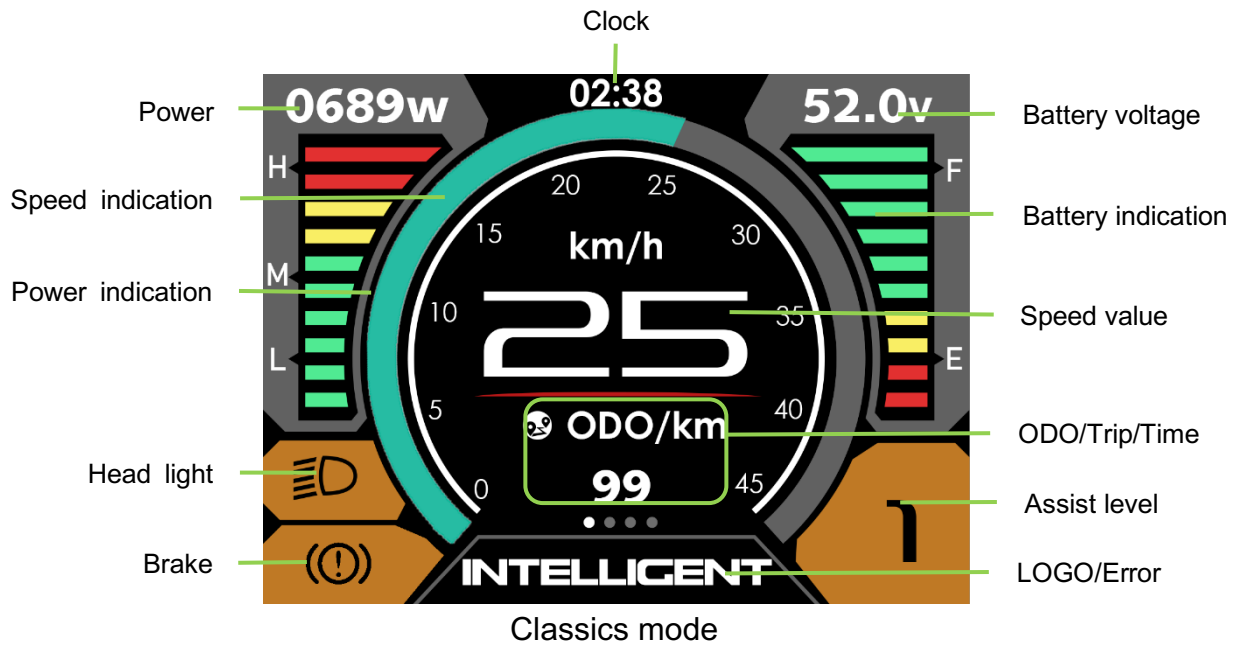



- **Clock:** Displayed in digital mode, 12h or 24h.
- **Bluetooth:** Show the Bluetooth connection status.
- **Head Light:** Head Light on/ off.
- **Mileage mode/Riding time:**
 Modern page: TRIPA (Data reset after shutdown)
 Classics page: TRIPA (Data reset after shutdown), TRIPB (Data is saved after shutdown), Odometer, Range, TIMEA (Data reset after shutdown), TIMEB (Data is saved after shutdown).
- **Speed Value:** Real-time Speed, KM/H or MPH.
- **Speed indication:** When the speed limit is less than 40km/h, the maximum

indicator is 45; when the speed limit is more than 40km/h, the maximum indicator is 90; if the real-time speed exceeds the maximum indicated, its display is not affected.

- **Smart battery Power indicator:** Provide a reliable battery Power indicator.
- **Assist level:** Displays the current assist level.
- **Brake:** Show  when checking error.
- **Error Code:** Show  when checking error.
- **LOGO.**

7 Functional Description



7.1 Power On/Off

Press **POWER** button for 2 seconds, you can turn on/off the display. The Display can automatically turn off when there is no operating and riding for 5 minutes. (The time can be set, refer to 8.1.4 'Auto off')

*Input pattern in first if pattern unlock was activated.

*Display will be locked for 30 seconds after 3 times failed attempt.

7.2 Assist levels

Press **UP/DOWN** button to change assist level. If the default setting is 5-gear: Top assist level is 5, 0 for neutral. Level quantities can be adjusted according to the customer requirements.

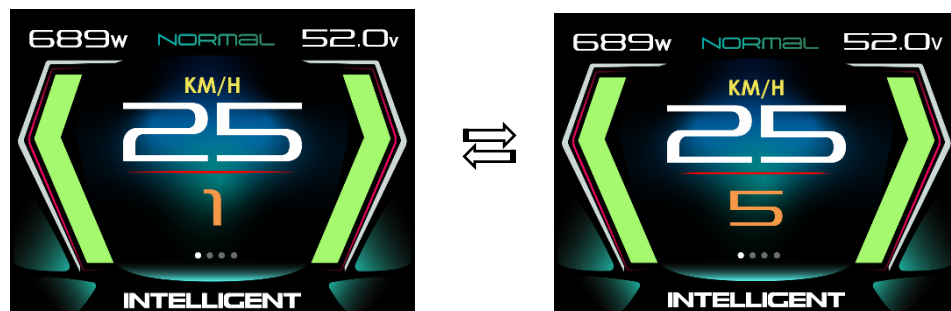

7.3 Screen Switching

Press **POWER** button to switch the screen, including Main Page, Bluetooth Page, Basic information Page and Information Page(The Main Page can be set, refer to 8.1.5 'Scenes').



Main Page –Modern/ Classics mode

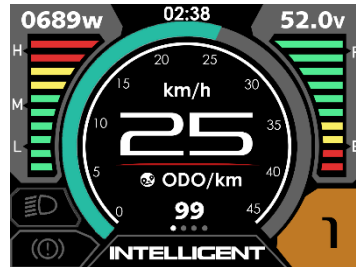

Bluetooth Page

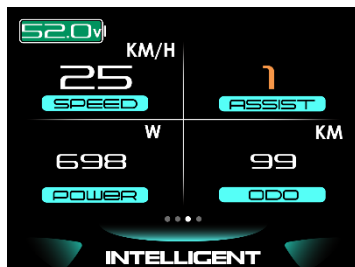

Basic information Page

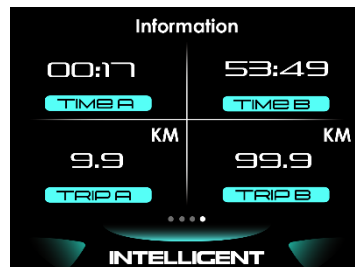

Information-1



Information-2

7.4 Headlight / Display Mode

Press and hold **UP** button for 2 seconds can turn on/off headlight, display will switch to the corresponding mode (Day or Night).



Day



Night

* The brightness of the Display can be set according to the user's needs, Refer 8.1.3 Brightness.

* The motor does not work when the battery voltage is low, Display still can keep the headlight on for a while when E-bike is in riding.

7.5 Walking mode (6km)

Press and hold **DOWN** button for 2 seconds can get into walking mode, show 'P' and real-time speed on the screen, out of walking mode when releasing the button.



Walking Mode

7.6 Bluetooth

Installing the “I-Bike” mobile app, turn on the Bluetooth of the mobile phone.

Open “I-Bike” app, click “Scan for device”, find “600C-BLE” and connect, input the 6-digit pairing key and click "pair".

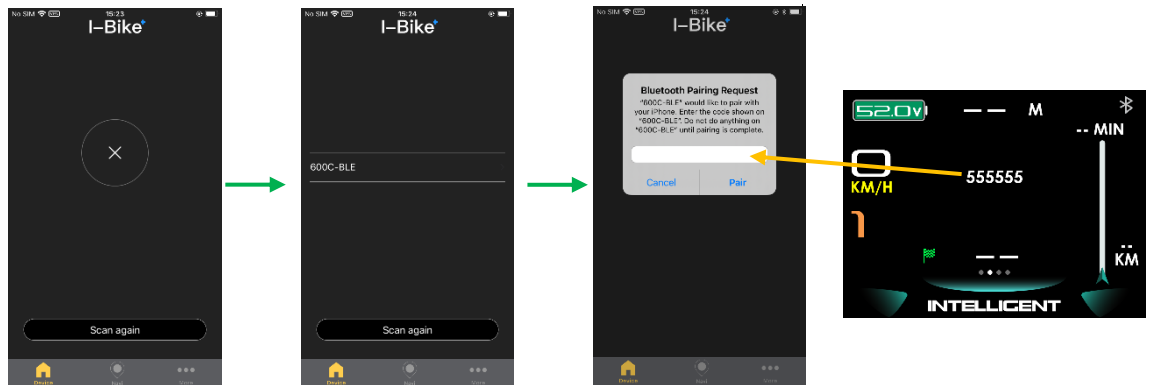

After the Bluetooth pairing is successful, is displayed in blue, and the I-Bike APP will enter the main interface. When the mobile phone calls, receives messages, etc., the Display can show the reminder icon.

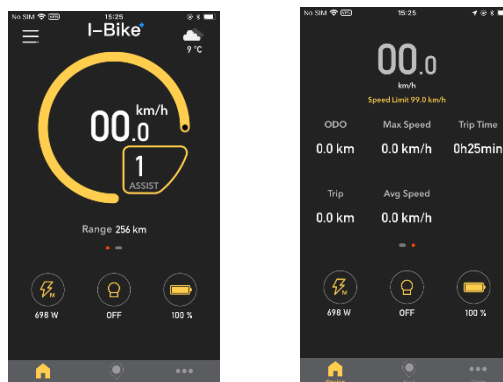

Main Interface

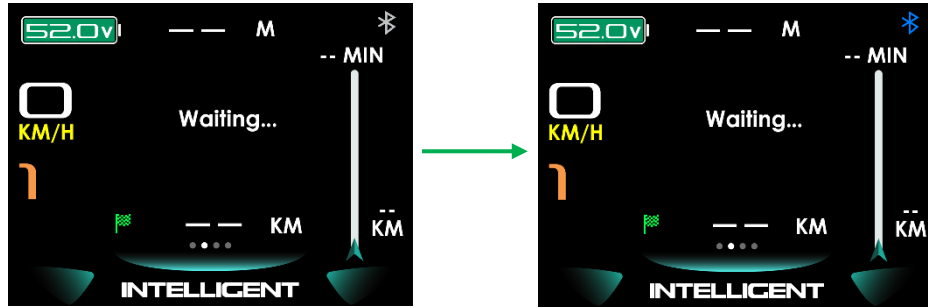

Interface before Bluetooth pairing

Interface after Bluetooth pairing

*Phone that has successfully connected to the Display's Bluetooth does not need to be paired again.

*Please note:

For some Android™ driven smartphones, there might occur eventual Bluetooth™ connection problems with the APT display due to software mismatches.

➤ **Settings**

Click the upper left corner of the "I-Bike" app to enter the Settings menu, including Display Settings, E-Bike Info and Battery Info.

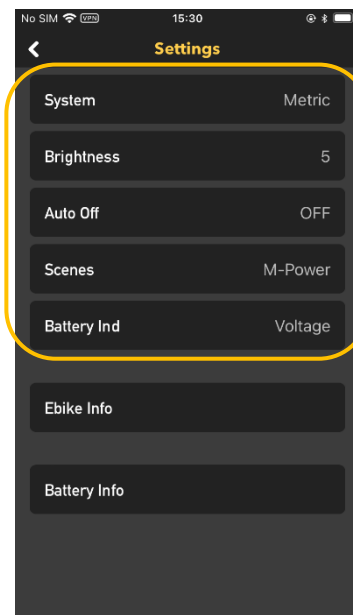

Display's parameters can be set

Settings page

➤ **Navigation**

Click "Navi" to enter the navigation interface of the "I-Bike" APP; After the navigation starts, the Display navigation interface can show the remaining mileage, the riding mileage, the remaining time of riding, navigation instruction and the warning of low battery power at end of endurance

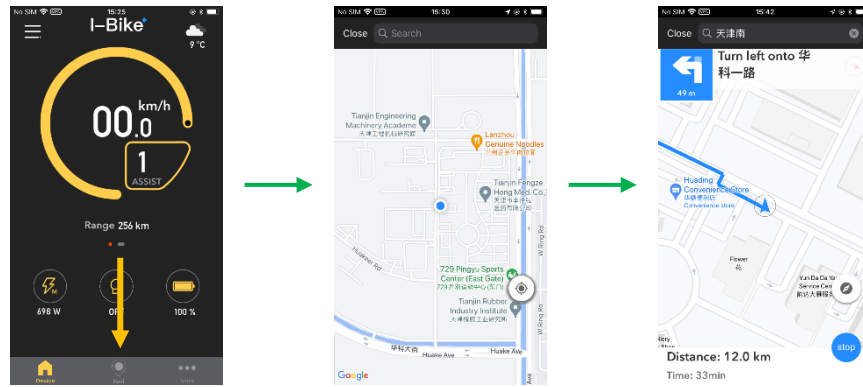

Main interface

Phone's navigation interface

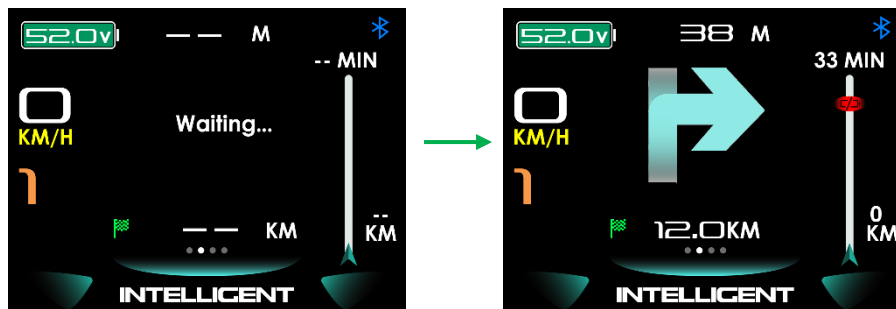

Display's navigation interface

* The version information of the “I-Bike” APP is displayed in “More” on the main interface of the APP.

7.7 Data cleanup

Press and hold **UP** & **DOWN** button together for 1 second can clean temporary data (TRIPB, TIME B, AVG SPD, MAX SPD data).

- * Temporary data is automatically saved when power off. Abnormal power outage will cause data lost.
- * Restore Factory Mode (advanced settings in Menu Page) can clear temporary data (TRIPA TRIPB, TIMEA, TIMEB, AVG SPD, MAX SPD, MENU settings) except ODO.
- * ODO will reset to zero over 99999km. TRIPB will reset to zero over 9999.9km.

8 Menu Page

Double press **MENU** button (press interval less than 0.3 second) can get into setting menus, press **UP/DOWN** button to change the parameter setting, press **MENU** button can get into or save the settings. Select EXIT or press **MENU** button twice to exit from menu.

- * Display will automatically quit menu if there is no operation for 30 seconds.
- * For safety reason, display will be locked on Main Page when riding (speed \geq 2.0km/h), function of MENU will be deactivated.
- * Display didn't save setting until click MENU to confirm.

* Display doesn't quit parameter adjustment interface through pressing **MENU** button.

8.1 Display settings

Display settings include several items: Language, System, Brightness, Auto off, Scenes, Clock, Focus.

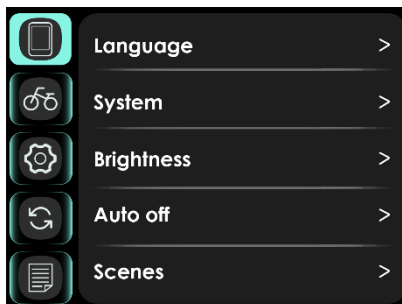

8.1.1 Language

6 languages are supported: Czech, German, French, English, Italian, Spanish. Default is English. Select language then click "Back" to confirm.

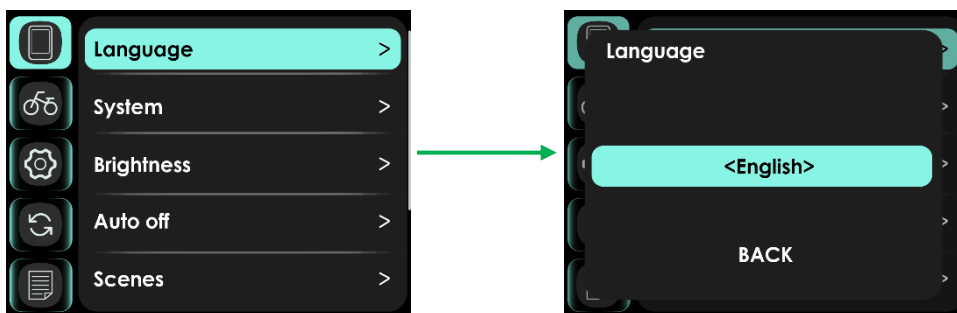

8.1.2 System

Select Metric or Imperial.

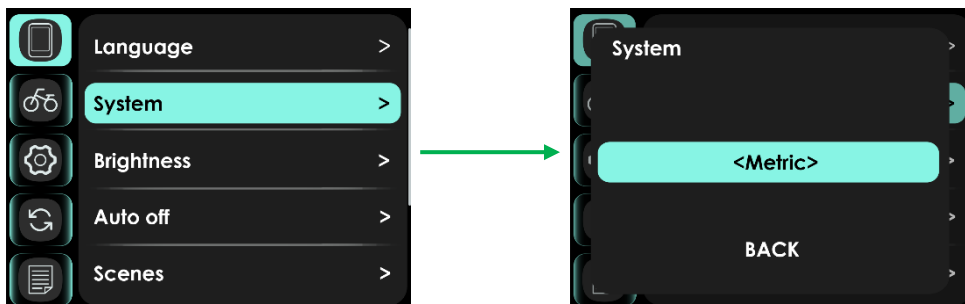

8.1.3 Brightness

You can set the backlight brightness in the light on and off state, press **UP/DOWN** button to change brightness of backlight, 1 is darkness, 5 is brightness.

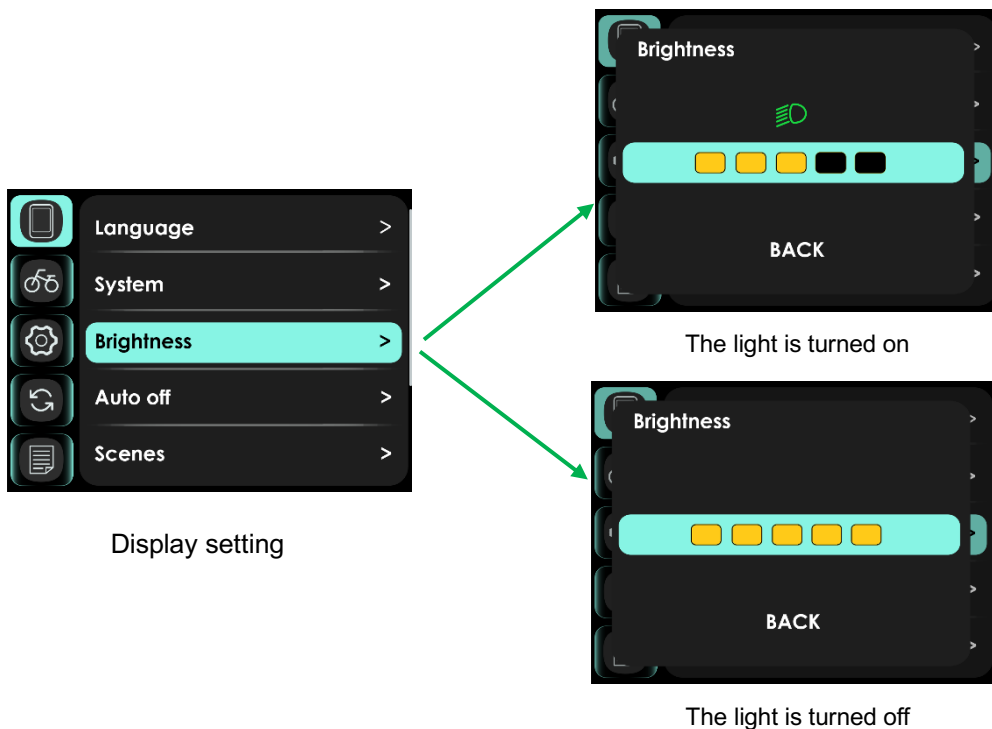

8.1.4 Auto off

This item enables to set the automatic shutdown time of the display, from 1 to 10min. Default value is 5 minutes, represents display shut down when there was no operation and riding for 5 minutes. OFF indicates that the display disables automatic shutdown.

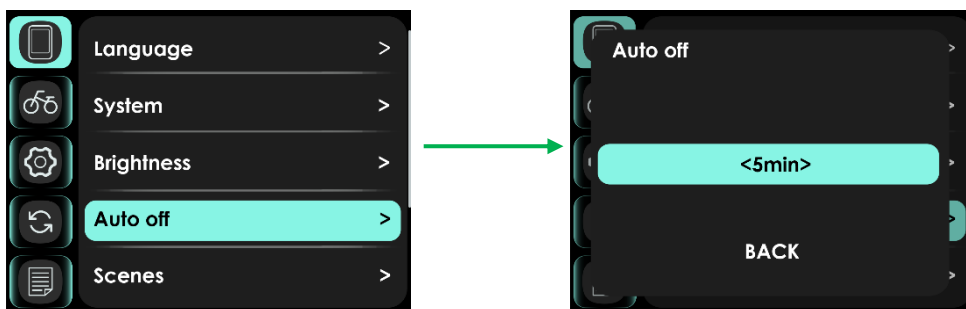

8.1.5 Scenes

Select Modern or Classics.

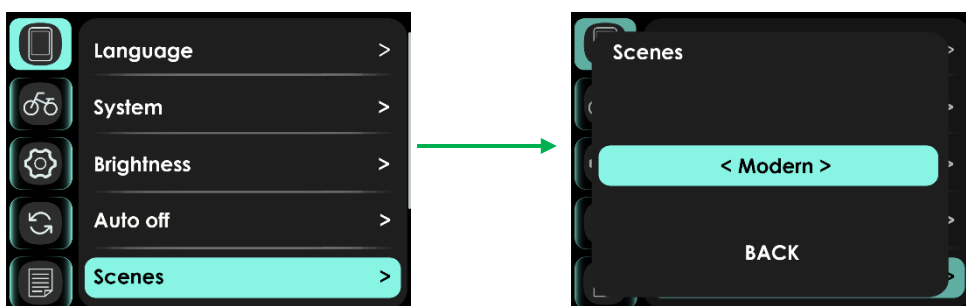

8.1.6 Clock

This item can set date and time. You can choose Show-12 hour, Show-24 hour on Main Page.

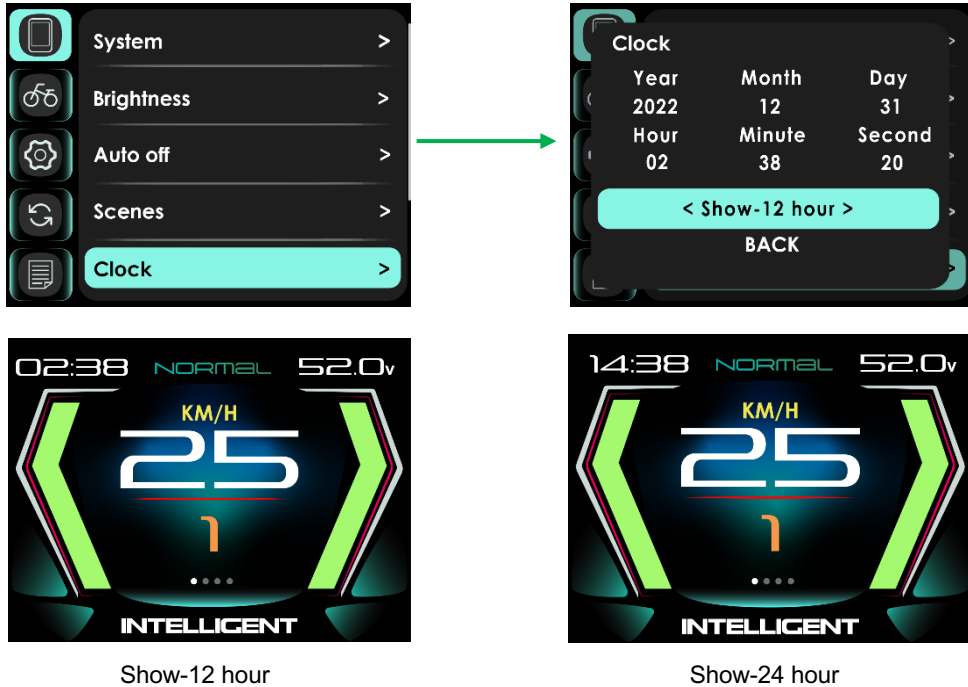

* Note: When display was powered off, internal Button Battery can keep clock running. When display is power on, Button Battery will be charged by external battery. If the display is not turned on for a long time, the Button Battery will drain (in winter or during long-distance transportation), Clock may slow or stop, please charge the battery as follows:

Set “Automatic shutdown” to “OFF” (Disable power off automatically), keep the display power on for 72 hours. Full charged Button Battery can keep clock running at least 3 months without charged.

8.1.7 Focus

6 Settings are supported: ODO, Trip A, Time A, Trip B, Time B and Range. The Settings are displayed on the Basic information screen and the Main screen.

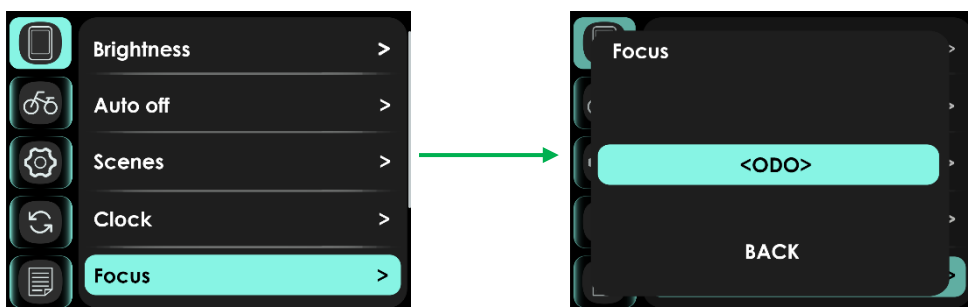

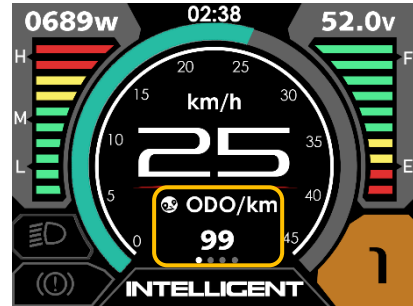
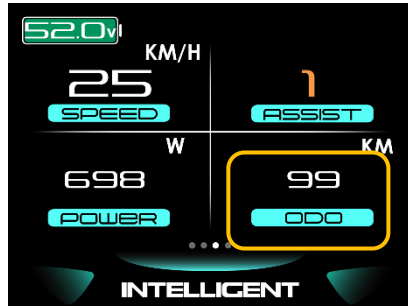

8.2 E-bike Settings

E-bike settings include several items: Start password, Assist levels, Wheelsize, Battery voltage, Battery Indexes, Pow Indexes, Pow range.

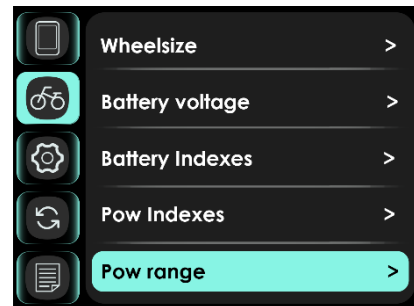
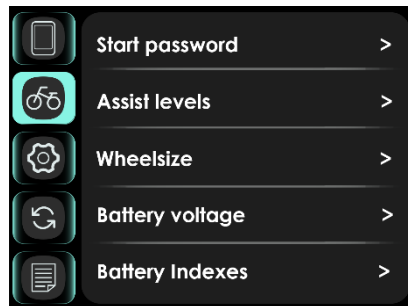

8.2.1 Start password

The start password includes two parameter settings, Start password, OFF/ON. If you had set start password ON, you must input right password before power on.

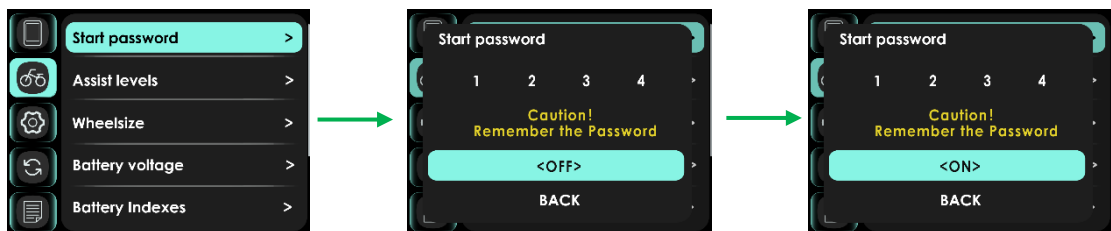

Turn on the start password function

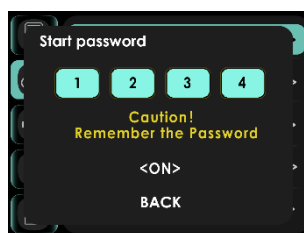

Start password setting page

You need to input the right password before start with 30 seconds.

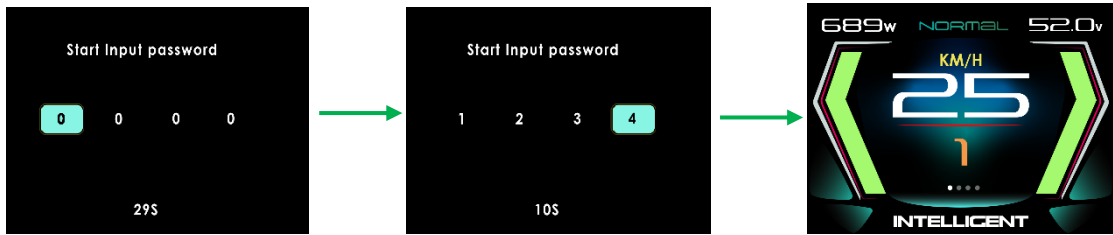

The boot page after setting the start password

* Display will automatically shut down if the correct password is not entered within 30S. Press and hold the **POWER** button to shut down while entering the password.

* Display will automatically shut down if the password was entered incorrectly 3 times.

8.2.2 Assist levels

This item can select assist levels, options are 3/4/5.

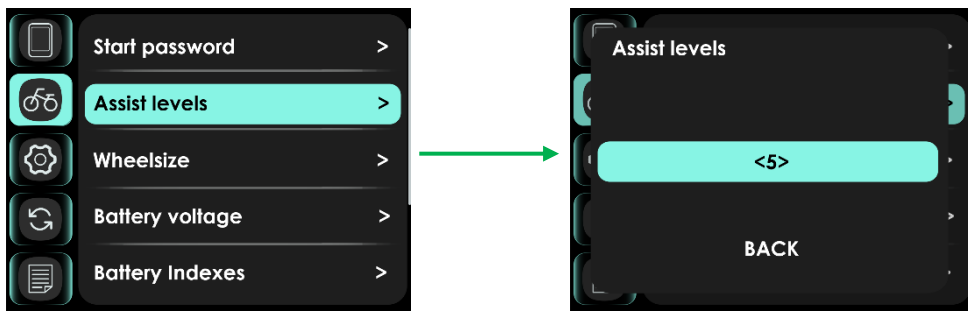

8.2.3 Wheelsize

This item can select wheel diameter, including 12/14/16/18/20/22/24/26/27/27.5/28~31 inch, 51cm~250cm. Incorrect wheel diameter selection can lead to abnormal speeds.

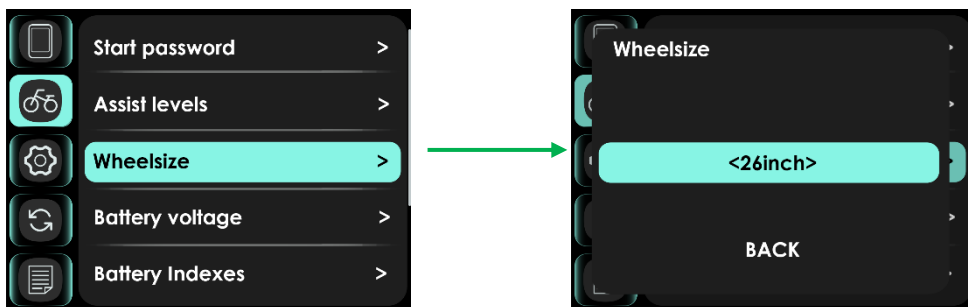

8.2.4 Battery voltage

The following voltage settings are supported: 24V/36V/48V/52V.

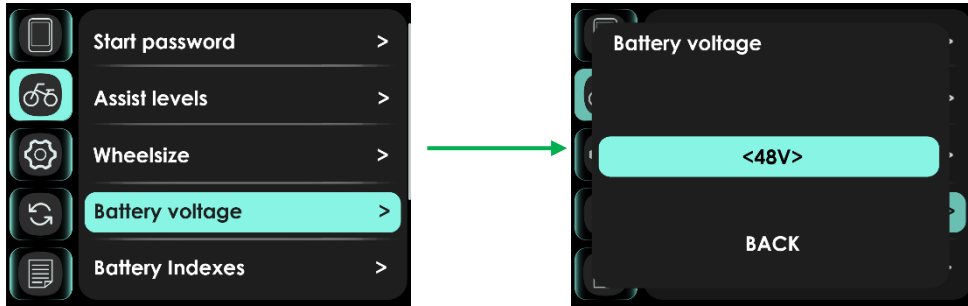

8.2.5 Battery Indexes

This item can select battery Indexes setting, including OFF, Percent, Voltage.

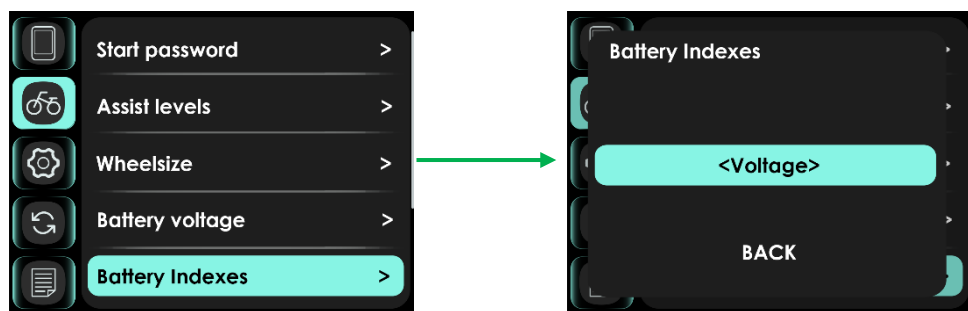

Voltage

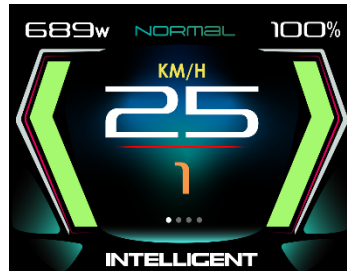

Percent



OFF

Note: The voltage is the remaining voltage or percentage of the battery.

8.2.6 Pow Indexes

Main Page can be set to display Power(W) , Current(A), Trip A, Range, Clock.

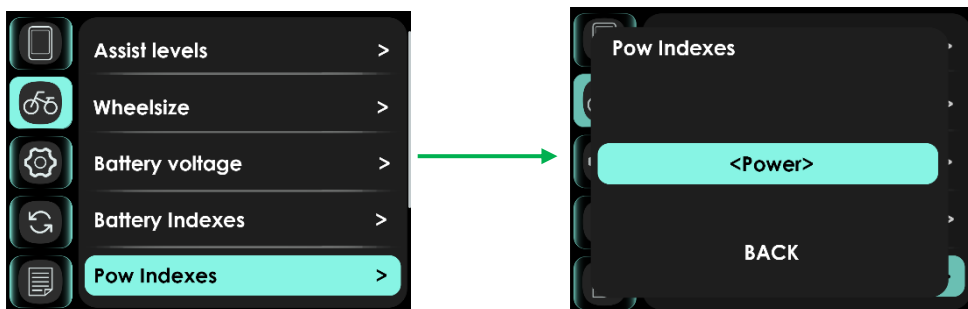

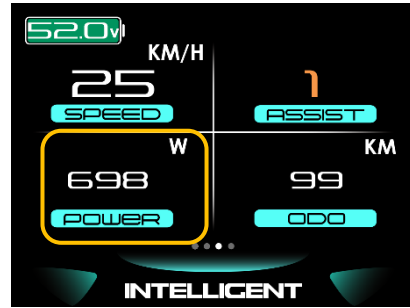

8.2.7 Pow range

Support Output power range Settings:

250W/500W/750W/1000W/1250W/1500W/1750W/2000W.

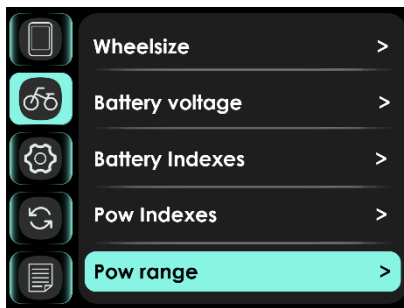

8.3 Advanced setting

Advanced settings have password to prevent illegal modification, default password is '1919', password may be different according to request.

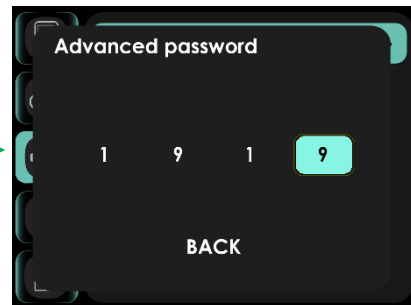
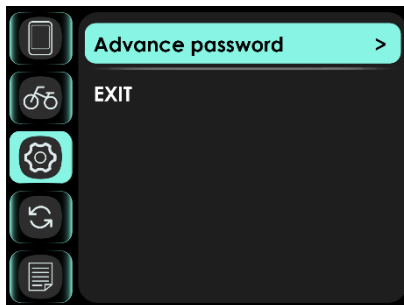

Input correctly password to enter advanced setting page, where you can adjust the speed limit, range 10km/h~60km/h, 99 km/h(6.2Mile/h~37.2Mile/h, 61.4 Mile/h), and where you can see the error code messages of the last 10 times.

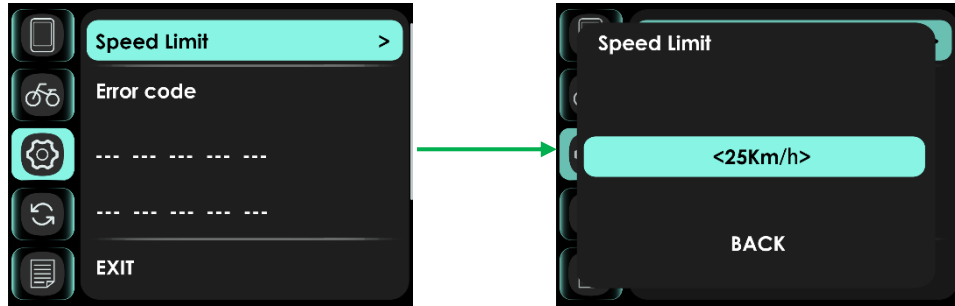

Note: The maximum speed is limited by the motor and controller, and it is not necessarily possible to reach the speed limit setting value.

8.4 Factory Setting

Select 'YES' will restore all setting to factory defaults.

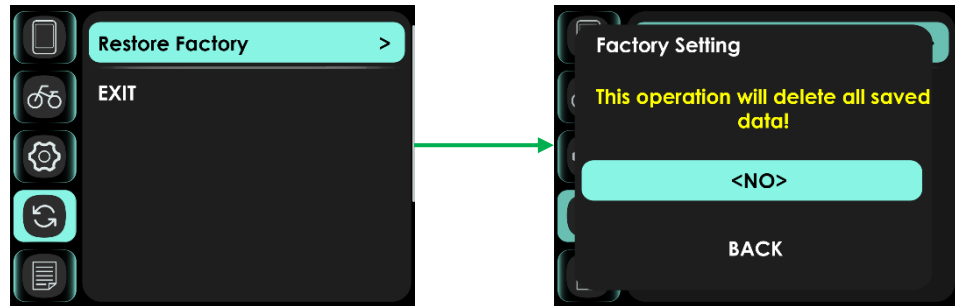

Note: ODO and CLOCK data are not cleared.

8.5 Information

The information display interface includes: Speed and Mileage Information, Product Information, Battery Information.



8.5.1 Product Infor

Product Information show Hardware Version, Software Version, Date...

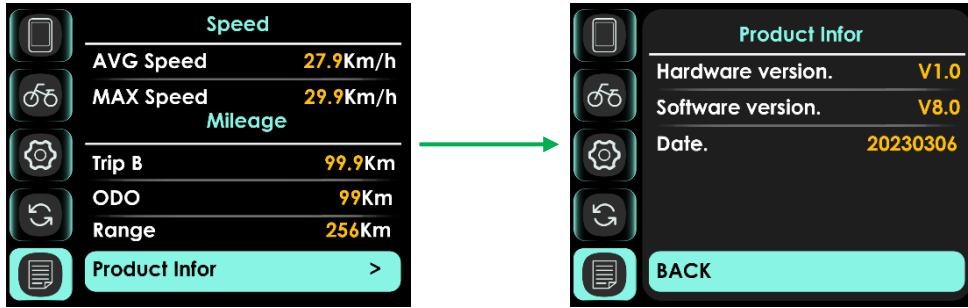

8.5.2 Battery Infor

Battery Voltage Information can be showed.

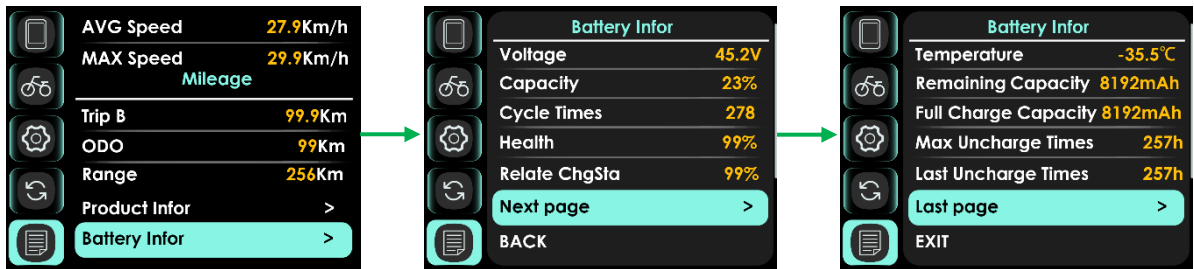

*The battery information is displayed when the E-bike is equipped with a battery with communication function.

9 Errors code

Display shows error code and  at the bottom of the screen when system checked abnormal.

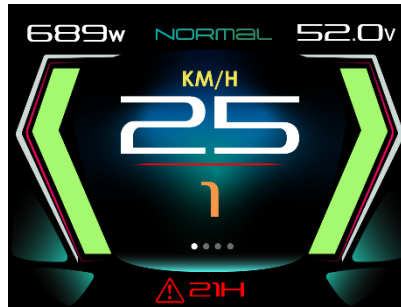

Error code prompt page

Error Code	Error description	Handle
04	Throttle error	Check throttle and connection
05	Throttle turn back fault	Check throttle and connection
07	Overvoltage protection	
08	Hall error	Check the hall connection
09	three-phase power error	Check three-phase power line connection
10	The controller is overheated	Stop using 10 minutes to restart
11	Motor overheating	Stop using 10 minutes to restart
12	Current sensor error	Check the sensor connection
13	battery temperature abnormality	Stop using 10 minutes to restart

14	Motor temperature sensor is abnormal	Check the sensor
15	Controller temperature sensor failure	Check the sensor
21	Speed sensor fault	Check the sensor
22	BMS Communication Error	Check the cable connection
23	Headlight error	Check the cable connection
24	Headlight sensor error	Check the cable connection
25	Torque sensor signal error	Contact the supplier
26	Torque sensor speed error	Contact the supplier
30	Communication Error	Check the cable connection

10 Assembly instructions

Please pay attention to the torque value, exceeding the maximum torque can damage the part.

Electrical or pneumatic tools is not recommended.

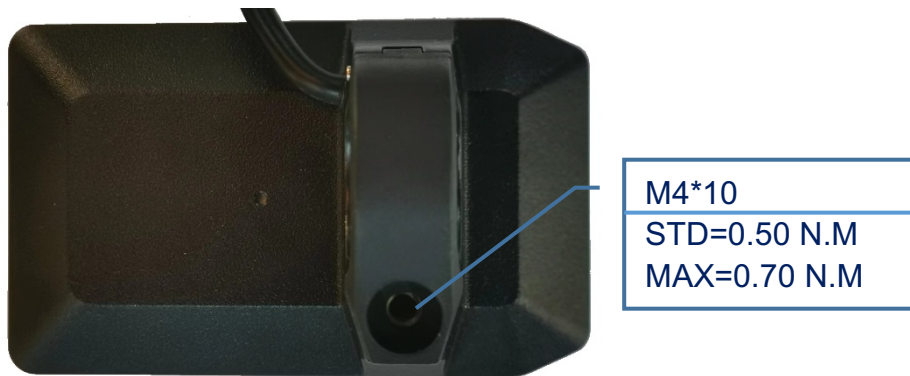

11 Install and use precautions

Do not adjust viewing angle before loose the screws.

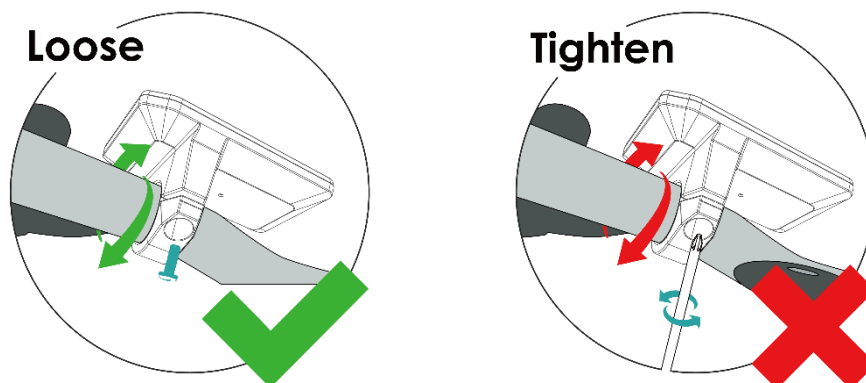

12 Copyright Notice

Questions about your e-bike, please contact with dealer firstly.

APT reserves the right to modify this specification file, without declaration in advance.

Content and Image owner: APT (Tianjin) Development Co., Ltd.

1001, Building 5 HuaDing, No.1 HuaKe 3 Road, Binhai hi-tech Industrial Development Zone, Tianjin, China

website : www.apdevelop.com

NOTE: This equipment has been tested and found to comply with the limits for a Class B digital device, pursuant to part 15 of the FCC Rules. These limits are designed to provide reasonable protection against harmful interference in a residential installation. This equipment generates, uses and can radiate radio frequency energy and, if not installed and used in accordance with the instructions, may cause harmful interference to radio communications. However, there is no guarantee that interference will not occur in a particular installation. If this equipment does cause harmful interference to radio or television reception, which can be determined by turning the equipment off and on, the user is encouraged to try to correct the interference by one or more of the following measures:

- Reorient or relocate the receiving antenna.
- Increase the separation between the equipment and receiver.
- Connect the equipment into an outlet on a circuit different from that to which the receiver is connected.
- Consult the dealer or an experienced radio/TV technician for help.

Changes or modifications not expressly approved by the party responsible for compliance could void the user's authority to operate the equipment.