



FCC TEST REPORT

FCC ID:2A8JV-RW401AP

Report Number..... : ZKT-2401050248E-3

Date of Test..... Jan. 05, 2024 to Jan. 22, 2024

Date of issue : Jan. 22, 2024

Total number of pages 95

Test Result : PASS

Testing Laboratory..... : **Shenzhen ZKT Technology Co., Ltd.**

Address : 1/F, No. 101, Building B, No. 6, Tangwei Community Industrial Avenue, Fuhai Street, Bao'an District, Shenzhen, China

Applicant's name : **Guangzhou Munbyn Information Technology Co, Ltd.**

Address : Unit L3A01-4, No.31-6 Xicha Road, Baiyun District, Guangzhou City, China.

Manufacturer's name : **Guangzhou Munbyn Information Technology Co, Ltd.**

Address : Unit L3A01-4, No.31-6 Xicha Road, Baiyun District, Guangzhou City, China.

Test specification:

Standard..... : FCC CFR Title 47 Part 15 Subpart E Section 15.407
ANSI C63.10:2013
KDB 789033 D02 v02r01

Test procedure..... : /

Non-standard test method : N/A

Test Report Form No. : /

Test Report Form(s) Originator : ZKT Testing

Master TRF : Dated: 2020-01-06

This device described above has been tested by ZKT, and the test results show that the equipment under test (EUT) is in compliance with the FCC requirements. And it is applicable only to the tested sample identified in the report.

This report shall not be reproduced except in full, without the written approval of ZKT, this document may be altered or revised by ZKT, personal only, and shall be noted in the revision of the document.

Product name..... : **Thermal Label Printer**

Trademark : N/A

Model/Type reference : RW401AP

P44S-S, P44AP, MY401AP, MY411AP, MY401AP-P, MY401AP-S

Input: 24V $\overline{\text{---}}$ 2000mA

Ratings..... : AC/DC Adapter Input: 100-240V ~ 50/60Hz, 2.0A

Output: 24V $\overline{\text{---}}$ 2000mA



Testing procedure and testing location:

Testing Laboratory: **Shenzhen ZKT Technology Co., Ltd.**

Address.....: 1/F, No. 101, Building B, No. 6, Tangwei Community Industrial Avenue, Fuhai Street, Bao'an District, Shenzhen, China

Tested by (name + signature).....: Jim Liu

Reviewer (name + signature).....: Jackson Fang

Approved (name + signature).....: Lake Xie





Table of Contents

Page

1. VERSION.....	5
2.SUMMARY OF TEST RESULTS	6
2.1 TEST FACILITY	7
2.2 MEASUREMENT UNCERTAINTY	7
3. GENERAL INFORMATION	8
3.1 GENERAL DESCRIPTION OF EUT	8
3.3 BLOCK DIGRAM SHOWING THE CONFIGURATION OF SYSTEM TESTED	11
3.4 DESCRIPTION OF SUPPORT UNITS(CONDUCTED MODE).....	11
3.5 EQUIPMENTS LIST FOR ALL TEST ITEMS.....	12
4.EMC EMISSION TEST	14
4.1 CONDUCTED EMISSION MEASUREMENT	14
4.1.1 POWER LINE CONDUCTED EMISSION LIMITS.....	14
4.1.2 TEST PROCEDURE	14
4.1.3 DEVIATION FROM TEST STANDARD.....	14
4.1.4 TEST SETUP	15
4.1.5 EUT OPERATING CONDITIONS.....	15
4.1.6 TEST RESULT	16
4.2 RADIATED EMISSION MEASUREMENT.....	20
4.2.1 APPLICABLE STANDARD.....	20
4.2.2 CONFORMANCE LIMIT	20
4.2.3 MEASURING INSTRUMENTS.....	20
4.2.4 TEST CONFIGURATION	21
4.2.5 TEST PROCEDURE	22
4.2.6 TEST RESULT	23
5.POWER SPECTRAL DENSITY TEST	39
5.1 APPLIED PROCEDURES / LIMIT	39
5.2 TEST PROCEDURE	40
5.3 DEVIATION FROM STANDARD.....	40
5.4 TEST SETUP	40
5.5 EUT OPERATION CONDITIONS.....	40
5.6 TEST RESULTS.....	41
6. 26DB EMISSION BANDWIDTH & 6DB OCCUPIED BANDWIDTH	49
6.1 APPLIED PROCEDURES / LIMIT	49
6.2 TEST PROCEDURE	49
6.3 EUT OPERATION CONDITIONS.....	49
6.4 TEST RESULTS	50
7.MAXIMUM CONDUCTED OUTPUT POWER	58
7.1 PPLIED PROCEDURES / LIMIT	58
7.2 TEST PROCEDURE	58
7.3 DEVIATION FROM STANDARD.....	59
7.4 TEST SETUP	59
7.5 EUT OPERATION CONDITIONS.....	59
7.6 TEST RESULTS	60
8.OUT OF BAND EMISSIONS	62
8.1 APPLICABLE STANDARD.....	62
8.2 TEST PROCEDURE	62
8.3 DEVIATION FROM STANDARD.....	62



Table of Contents

Page

8.4 TEST SETUP	62
8.5 EUT OPERATION CONDITIONS	62
8.6 TEST RESULTS	63
9.SPURIOUS RF CONDUCTED EMISSIONS	67
9.1 CONFORMANCE LIMIT	67
9.2 MEASURING INSTRUMENTS	67
9.3 TEST SETUP	67
9.4 TEST PROCEDURE	67
9.5 TEST RESULTS	67
10.FREQUENCY STABILITY MEASUREMENT	74
10.1 LIMIT	74
10.2 TEST PROCEDURES	74
10.3 TEST SETUP LAYOUT	74
10.4 EUT OPERATION DURING TEST	74
10.5 TEST RESULTS	74
11. DUTY CYCLE	85
11.1 APPLIED PROCEDURES / LIMIT	85
11.2 DEVIATION FROM STANDARD	85
11.3 TEST SETUP	85
12.ANTENNA REQUIREMENT	94
13. TEST SETUP PHOTO	95
14. EUT CONSTRUCTIONAL DETAILS	95



1. VERSION

Report No.	Version	Description	Approved
ZKT-2401050248E-3	Rev.01	Initial issue of report	Jan. 22, 2024



2.SUMMARY OF TEST RESULTS

Test procedures according to the technical standards:

FCC Part15 (15.407) , Subpart E			
Standard Section	Test Item	Judgment	Remark
15.207	AC Power Line Conducted Emission	PASS	
789033 D02 General U-NII	Duty Cycle	PASS	
15.209(a) 15.407 (b)(1) 15.407 (b)(4) 15.407 (b)(8)	Spurious Radiated Emissions	PASS	
15.407 (a)(12) 15.407(e)	26dB Emission Bandwidth & 6dB Occupied Bandwidth	PASS	
15.407 (a)(1) 15.407 (a)(3)	Maximum Conducted Output Power	PASS	
2.1051, 15.407(b)(1) 15.407(b)(4)	Band Edge	PASS	
15.407 (a)(1) 15.407 (a)(3)	Power Spectral Density	PASS	
2.1051, 15.407(b)	Spurious Emissions at Antenna Terminals	PASS	
15.203	Antenna Requirement	PASS	

NOTE:

(1)" N/A" denotes test is not applicable in this Test Report



2.1 TEST FACILITY

Shenzhen ZKT Technology Co., Ltd.
Add. : 1/F, No. 101, Building B, No. 6, Tangwei Community Industrial Avenue, Fuhai Street, Bao'an District, Shenzhen, China

FCC Test Firm Registration Number: 692225
Designation Number: CN1299
IC Registered No.: 27033
CAB identifier: CN0110

2.2 MEASUREMENT UNCERTAINTY

The reported uncertainty of measurement $y \pm U$ · where expanded uncertainty U is based on a standard uncertainty multiplied by a coverage factor of $k=2$ · providing a level of confidence of approximately 95 % ·

No.	Item	Uncertainty
1	3m chamber Radiated spurious emission(9KHz-30MHz)	U=4.5dB
2	3m chamber Radiated spurious emission(30MHz-1GHz)	U=4.8dB
3	3m chamber Radiated spurious emission(1GHz-6GHz)	U=4.9dB
4	3m chamber Radiated spurious emission(6GHz-40GHz)	U=5.0dB
5	Conducted disturbance	U=3.2dB
6	RF Band Edge	U=1.68dB
7	RF power conducted	U=1.86dB
8	RF conducted Spurious Emission	U=2.2dB
9	RF Occupied Bandwidth	U=1.8MHz
10	RF Power Spectral Density	U=1.75dB
11	humidity uncertainty	U=5.3%
12	Temperature uncertainty	U=0.59°C



3. GENERAL INFORMATION

3.1 GENERAL DESCRIPTION OF EUT

Product Name:	Thermal Label Printer	
Model No.:	RW401AP	
Serial Model:	P44S-S, P44AP, MY401AP, MY411AP, MY401AP-P, MY401AP-S	
Model Different.:	All the model are the same circuit and RF module, only the model name is different.	
Sample ID	ZKT-2401050248E-3	
Sample(s) Status:	Engineer sample	
Product Description	IEEE 802.11 WLAN Mode Supported	<input checked="" type="checkbox"/> 802.11a/n/ac (20MHz channel bandwidth) <input checked="" type="checkbox"/> 802.11ac/n (40MHz channel bandwidth) <input checked="" type="checkbox"/> 802.11ac (80MHz channel bandwidth)
	Data Rate	802.11a 802.11n(HT20/HT40):MCS0-MCS7; 802.11ac(VHT20/VHT40/VHT80):MCS0-MCS9
	Modulation	OFDM with BPSK / QPSK / 16-QAM / 64-QAM for 802.11a/n; OFDM with BPSK / QPSK / 16-QAM / 64-QAM / 256-QAM for 802.11ac;
	Operating Frequency Range	<input checked="" type="checkbox"/> 5180-5240MHz for 802.11a/n20/ac20; <input checked="" type="checkbox"/> 5190-5230MHz for 802.11ac40/n40; <input checked="" type="checkbox"/> 5210MHz for 802.11 ac80. <input checked="" type="checkbox"/> 5745-5825 MHz for 802.11a/n20/ac20; <input checked="" type="checkbox"/> 5755-5795 MHz for 802.11ac40/n40; <input checked="" type="checkbox"/> 5775MHz for 802.11 ac80.
	Number of Channels	<input checked="" type="checkbox"/> 4 channels for 802.11a/n20/ac20 in the 5180-5240MHz band ; <input checked="" type="checkbox"/> 2 channels for 802.11 ac40/n40 in the 5190-5230 MHz band ; <input checked="" type="checkbox"/> 1 channels for 802.11 ac80 in the 5210MHz band. <input checked="" type="checkbox"/> 5 channels for 802.11a/n20/ac20 in the 5745-5825MHz band ; <input checked="" type="checkbox"/> 2 channels for 802.11 ac40/n40 in the 5755-5795 MHz band ; <input checked="" type="checkbox"/> 1 channels for 802.11 ac80 in the 5775MHz band
Channel List	Please refer to the Note 2.	
Antenna Type:	PCB antenna	
Antenna gain:	5.2G: 0.72dBi 5.8G: 0.56dBi	
Power supply:	Input: 24V 2000mA	
AC/DC Adapter:	Input: 100-240V ~ 50/60Hz, 2.0A Output: 24V 2000mA	
AC/DC Adapter Mode:	GM53-240200-F	

Note:

For a more detailed features description, please refer to the manufacturer's specifications or the User's Manual.



802.11a/n/ac(20MHz) Frequency Channel for 5.2G							
Channel	Frequency (MHz)	Channel	Frequency (MHz)	Channel	Frequency (MHz)	Channel	Frequency (MHz)
36	5180	44	5200	40	5220	48	5240

802.11n/ac(40MHz) Frequency Channel for 5.2G							
Channel	Frequency (MHz)	Channel	Frequency (MHz)	Channel	Frequency (MHz)	Channel	Frequency (MHz)
38	5190	46	5230	-	-	-	-

802.11ac (80MHz) Frequency Channel for 5.2G	
Channel	Frequency (MHz)
42	5210

802.11a/n/ac(20 MHz) Frequency Channel for 5.8G							
Channel	Frequency (MHz)	Channel	Frequency (MHz)	Channel	Frequency (MHz)	Channel	Frequency (MHz)
149	5745	153	5765	157	5785	161	5805
165	5825	-	-	-	-	-	-

802.11n/ac(40MHz) Frequency Channel for 5.8G					
Channel	Frequency (MHz)	Channel	Frequency (MHz)	Channel	Frequency (MHz)
151	5755	159	5795	-	-

802.11ac (80MHz) Frequency Channel for 5.8G	
Channel	Frequency (MHz)
155	5775



3.2 DESCRIPTION OF TEST MODES

Transmitting mode	Keep the EUT in continuously transmitting mode
Remark: During the test, the test voltage was tuned from 85% to 115% of the nominal rated supply voltage, and found that the worst case was under the nominal rated supply condition. So the report just shows that condition's data.	

Test Software	CMD
Power level setup	Default

Pretest Mode	Description
Mode 1	802.11a/n20/ac20 CH 36/ CH 40/ CH 48 for 5.2G 802.11a/n20/ac20 CH149/ CH157/ CH 165 for 5.8G
Mode 2	802.11n 40/ac 40 CH38/ CH 46 for 5.2G 802.11n 40/ac 40 CH 151 / CH 159 for 5.8G
Mode 3	802.11 ac80 CH 42 for 5.2G 802.11 ac80 CH 155 for 5.8G

For Conducted Emission	
Final Test Mode	Description
Mode 1	802.11a/n20/ac20 CH 36/ CH 40/ CH 48 for 5.2G 802.11a/n20/ac20 CH149/ CH157/ CH 165 for 5.8G
Mode 2	802.11n 40/ac 40 CH38/ CH 46 for 5.2G 802.11n 40/ac 40 CH 151 / CH 159 for 5.8G
Mode 3	802.11 ac80 CH 42 for 5.2G 802.11 ac80 CH 155 for 5.8G

For Radiated Emission	
Final Test Mode	Description
Mode 1	802.11a/n20/ac20 CH 36/ CH 40/ CH 48 for 5.2G 802.11a/n20/ac20 CH149/ CH157/ CH 165 for 5.8G
Mode 2	802.11n 40/ac 40 CH38/ CH 46 for 5.2G 802.11n 40/ac 40 CH 151 / CH 159 for 5.8G
Mode 3	802.11 ac80 CH 42 for 5.2G 802.11 ac80 CH 155 for 5.8G

Note:

(1) The measurements are performed at all Bit Rate of Transmitter, the worst data was reported.



3.3 BLOCK DIGRAM SHOWING THE CONFIGURATION OF SYSTEM TESTED

Conducted Emission



Radiated Emission

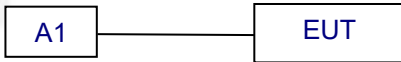

Conducted Spurious

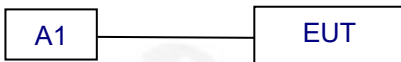

3.4 DESCRIPTION OF SUPPORT UNITS(CONDUCTED MODE)

The EUT has been tested as an independent unit together with other necessary accessories or support units. The following support units or accessories were used to form a representative test configuration during the tests.

Item	Equipment	Mfr/Brand	Model/Type No.	Series No.	Note
E-1	Thermal Label Printer	N/A	RW401AP	See page 8	EUT
A1	AC/DC Adapter	GVE	J GM53-240200-F	N/A	EUT

Item	Shielded Type	Ferrite Core	Length	Note

Note:

- (1) The support equipment was authorized by Declaration of Confirmation.
- (2) For detachable type I/O cable should be specified the length in cm in 『Length』 column.



3.5 EQUIPMENTS LIST FOR ALL TEST ITEMS

Conduction Test equipment

Item	Kind of Equipment	Manufacturer	Type No.	Serial No.	Firmware Version	Last calibration	Calibrated until
1	LISN	R&S	ENV216	101471	N/A	Nov. 14, 2023	Nov. 13, 2024
2	LISN	CYBERTEK	EM5040A	E1850400149	N/A	Nov. 02, 2023	Nov. 01, 2024
3	Test Cable	N/A	C-01	N/A	N/A	Nov. 02, 2023	Nov. 01, 2024
4	Test Cable	N/A	C-02	N/A	N/A	Nov. 02, 2023	Nov. 01, 2024
5	Test Cable	N/A	C-03	N/A	N/A	Nov. 02, 2023	Nov. 01, 2024
6	EMI Test Receiver	R&S	ESCI3	101393	4.42 SP3	Nov. 02, 2023	Nov. 01, 2024
7	Triple-Loop Antenna	N/A	RF300	N/A	N/A	Nov. 02, 2023	Nov. 01, 2024
8	Absorbing Clamp	DZ	ZN23201	15034	N/A	Nov. 07, 2023	Nov. 06, 2024
9	EMC Software	Frad	EZ-EMC	Ver.EMC-CON 3A1.1	N/A	\	\

Radiation Test equipment

Item	Equipment	Manufacturer	Type No.	Serial No.	Firmware Version	Last calibration	Calibrated until
1	Spectrum Analyzer (9kHz-26.5GHz)	KEYSIGHT	9020A	MY55370835	A.17.05	Nov. 02, 2023	Nov. 01, 2024
2	Spectrum Analyzer (10kHz-39.9GHz)	R&S	FSV40-N	100363	1.71 SP2	Nov. 02, 2023	Nov. 01, 2024
3	EMI Test Receiver (9kHz-7GHz)	R&S	ESCI7	101169	4.32	Nov. 02, 2023	Nov. 01, 2024
4	Bilog Antenna (30MHz-1500MHz)	Schwarzbeck	VULB9168	N/A	N/A	Nov. 13, 2023	Nov. 12, 2024
5	Horn Antenna (1GHz-18GHz)	Agilent	AH-118	071145	N/A	Nov. 13, 2023	Nov. 12, 2024
6	Horn Antenna (15GHz-40GHz)	A.H.System	SAS-574	588	N/A	Nov. 13, 2023	Nov. 12, 2024
7	Loop Antenna	TESEQ	HLA6121	58357	N/A	Nov. 16, 2023	Nov. 15, 2024
8	Amplifier (30-1000MHz)	EM Electronics	EM330 Amplifier	060747	N/A	Nov. 02, 2023	Nov. 01, 2024
9	Amplifier (1GHz-26.5GHz)	Agilent	8449B	3008A00315	N/A	Nov. 02, 2023	Nov. 01, 2024
10	Amplifier (500MHz-40GHz)	QuanJuDa	DLE-161	097	N/A	Nov. 02, 2023	Nov. 01, 2024
11	Test Cable	N/A	R-01	N/A	N/A	Nov. 02, 2023	Nov. 01, 2024
12	Test Cable	N/A	R-02	N/A	N/A	Nov. 02, 2023	Nov. 01, 2024
13	Test Cable	N/A	R-03	N/A	N/A	Nov. 02, 2023	Nov. 01, 2024
14	D.C. Power Supply	LongWei	TPR-6405D	N/A	N/A	\	\
15	EMC Software	Frad	EZ-EMC	Ver.EMC-CO N 3A1.1	N/A	\	\
16	Turntable	MF	MF-7802BS	N/A	N/A	\	\
17	Antenna tower	MF	MF-7802BS	N/A	N/A	\	\



RF Test equipment

Item	Equipment	Manufacturer	Type No.	Serial No.	Firmware Version	Last calibration	Calibrated until
1	Spectrum Analyzer (9kHz-26.5GHz)	KEYSIGHT	9020A	MY55370835	A.17.05	Nov. 02, 2023	Nov. 01, 2024
2	Spectrum Analyzer (10kHz-39.9GHz)	R&S	FSV40-N	100363	1.71 SP2	Nov. 02, 2023	Nov. 01, 2024
3	Test Cable	N/A	RF-01	N/A	N/A	Nov. 02, 2023	Nov. 01, 2024
4	Test Cable	N/A	RF-02	N/A	N/A	Nov. 02, 2023	Nov. 01, 2024
5	Test Cable	N/A	RF-03	N/A	N/A	Nov. 02, 2023	Nov. 01, 2024
6	ESG Signal Generator	Agilent	E4421B	N/A	B.03.84	Nov. 02, 2023	Nov. 01, 2024
7	Signal Generator	Agilent	N5182A	N/A	A.01.87	Nov. 02, 2023	Nov. 01, 2024
8	Magnetic Field Probe Tester	Narda	ELT-400	0-0344	N/A	Nov. 16, 2023	Nov. 15, 2024
9	Wideband Radio Communication Test	R&S	CMW500	106504	V 3.7.22	Nov. 02, 2023	Nov. 01, 2024
10	MWRF Power Meter Test system	MW	MW100-RF CB	N/A	N/A	Nov. 02, 2023	Nov. 01, 2024
11	Power Meter	KEYSIGHT	N1912A P	N/A	A.05.00	Nov. 02, 2023	Nov. 01, 2024
12	D.C. Power Supply	LongWei	TPR-6405D	N/A	N/A	\	\
13	RF Software	MW	MTS8310	V2.0.0.0	N/A	\	\



4.EMC EMISSION TEST

4.1 CONDUCTED EMISSION MEASUREMENT

Test Requirement:	FCC Part15 C Section 15.207
Test Method:	ANSI C63.10:2013
Test Frequency Range:	150KHz to 30MHz
Receiver setup:	RBW=9KHz, VBW=30KHz, Sweep time=auto

4.1.1 POWER LINE CONDUCTED EMISSION Limits

FREQUENCY (MHz)	Limit (dBuV)		Standard
	Quasi-peak	Average	
0.15 -0.5	66 - 56 *	56 - 46 *	FCC
0.50 -5.0	56.00	46.00	FCC
5.0 -30.0	60.00	50.00	FCC

Note:

(1) *Decreases with the logarithm of the frequency.

4.1.2 TEST PROCEDURE

- a. The EUT was placed 0.8 meters from the horizontal ground plane with EUT being connected to the power mains through a line impedance stabilization network (LISN). All other support equipments powered from additional LISN(s). The LISN provide 50 Ohm/ 50uH of coupling impedance for the measuring instrument.
- b. Interconnecting cables that hang closer than 40 cm to the ground plane shall be folded back and forth in the center forming a bundle 30 to 40 cm long.
- c. I/O cables that are not connected to a peripheral shall be bundled in the center. The end of the cable may be terminated, if required, using the correct terminating impedance. The overall length shall not exceed 1 m.
- d. LISN at least 80 cm from nearest part of EUT chassis.
- e. For the actual test configuration, please refer to the related Item –EUT Test Photos.

4.1.3 DEVIATION FROM TEST STANDARD

No deviation



4.1.4 TEST SETUP

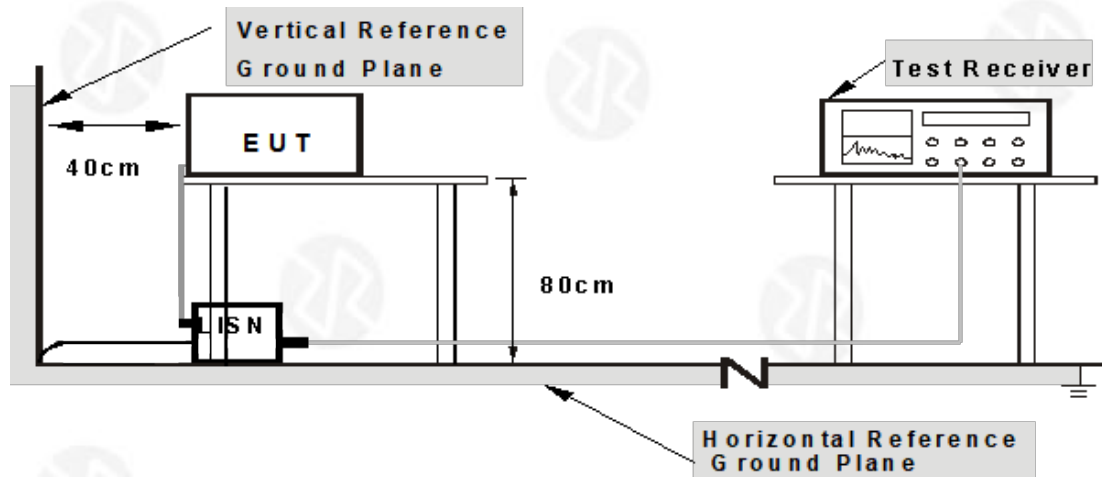

- Note:**
1. Support units were connected to second LISN.
 2. Both of LISNs (AMN) are 80 cm from EUT and at least 80 cm from other units and other metal planes

4.1.5 EUT OPERATING CONDITIONS

The EUT was configured for testing in a typical fashion (as a customer would normally use it). The EUT has been programmed to continuously transmit during test. This operating condition was tested and used to collect the included data.



4.1.6 TEST RESULT

5.2G:

Temperature:	26°C	Relative Humidity:	54%
Pressure:	101 kPa	Polarization:	L
Test Voltage:	AC 120V/60Hz	Test Mode:	802.11n20 - 5180MHz

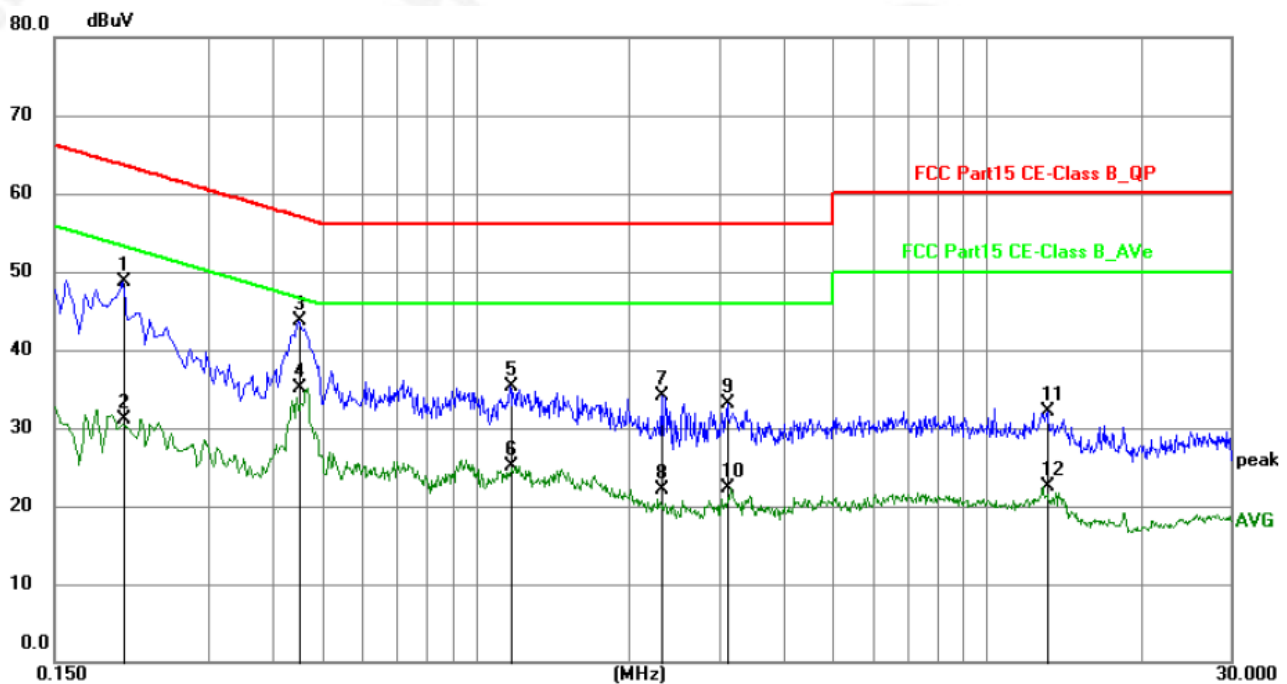

No.	Frequency (MHz)	Reading (dBuV)	Factor (dB)	Level (dBuV)	Limit (dBuV)	Margin (dB)	Detector	P/F
1	0.2040	27.82	20.96	48.78	63.45	-14.67	QP	P
2	0.2040	10.20	20.96	31.16	53.45	-22.29	AVG	P
3	0.4515	22.84	20.83	43.67	56.85	-13.18	QP	P
4	0.4515	14.21	20.83	35.04	46.85	-11.81	AVG	P
5	1.1670	14.44	20.78	35.22	56.00	-20.78	QP	P
6	1.1670	4.30	20.78	25.08	46.00	-20.92	AVG	P
7	2.3145	13.25	20.78	34.03	56.00	-21.97	QP	P
8	2.3145	1.26	20.78	22.04	46.00	-23.96	AVG	P
9	3.1110	12.25	20.76	33.01	56.00	-22.99	QP	P
10	3.1110	1.57	20.76	22.33	46.00	-23.67	AVG	P
11	13.1460	11.57	20.62	32.19	60.00	-27.81	QP	P
12	13.1460	1.86	20.62	22.48	50.00	-27.52	AVG	P



Temperature:	26°C	Relative Humidity:	54%
Pressure:	101 kPa	Polarization:	N
Test Voltage:	AC 120V/60Hz	Test Mode:	802.11n20 - 5180MHz

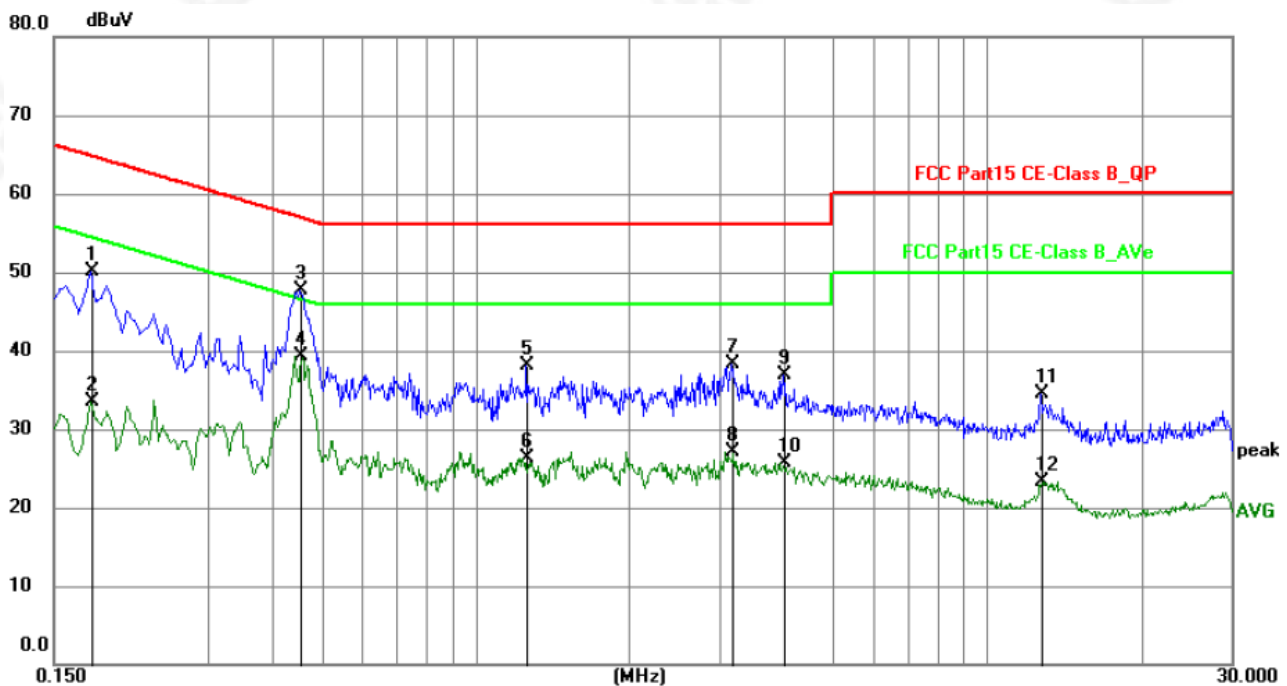

No.	Frequency (MHz)	Reading (dBuV)	Factor (dB)	Level (dBuV)	Limit (dBuV)	Margin (dB)	Detector	P/F
1	0.1770	29.31	20.87	50.18	64.63	-14.45	QP	P
2	0.1770	12.60	20.87	33.47	54.63	-21.16	AVG	P
3	0.4560	26.92	20.82	47.74	56.77	-9.03	QP	P
4	0.4560	18.41	20.82	39.23	46.77	-7.54	AVG	P
5	1.2615	17.35	20.77	38.12	56.00	-17.88	QP	P
6	1.2615	5.48	20.77	26.25	46.00	-19.75	AVG	P
7	3.1695	17.60	20.73	38.33	56.00	-17.67	QP	P
8	3.1695	6.44	20.73	27.17	46.00	-18.83	AVG	P
9	3.9975	16.10	20.72	36.82	56.00	-19.18	QP	P
10	3.9975	5.07	20.72	25.79	46.00	-20.21	AVG	P
11	12.7815	13.91	20.55	34.46	60.00	-25.54	QP	P
12	12.7815	2.69	20.55	23.24	50.00	-26.76	AVG	P

Notes:

1. An initial pre-scan was performed on the line and neutral lines with peak detector.
2. Quasi-Peak and Average measurement were performed at the frequencies with maximized peak emission.
3. Measurement Level = Reading level + Correct Factor
4. The test data shows only the worst case 802.11n20 - 5180MHz.



5.8G:

Temperature:	26°C	Relative Humidity:	54%
Pressure:	101 kPa	Polarization:	L
Test Voltage:	AC 120V/60Hz	Test Mode:	802.11n20 - 5745MHz

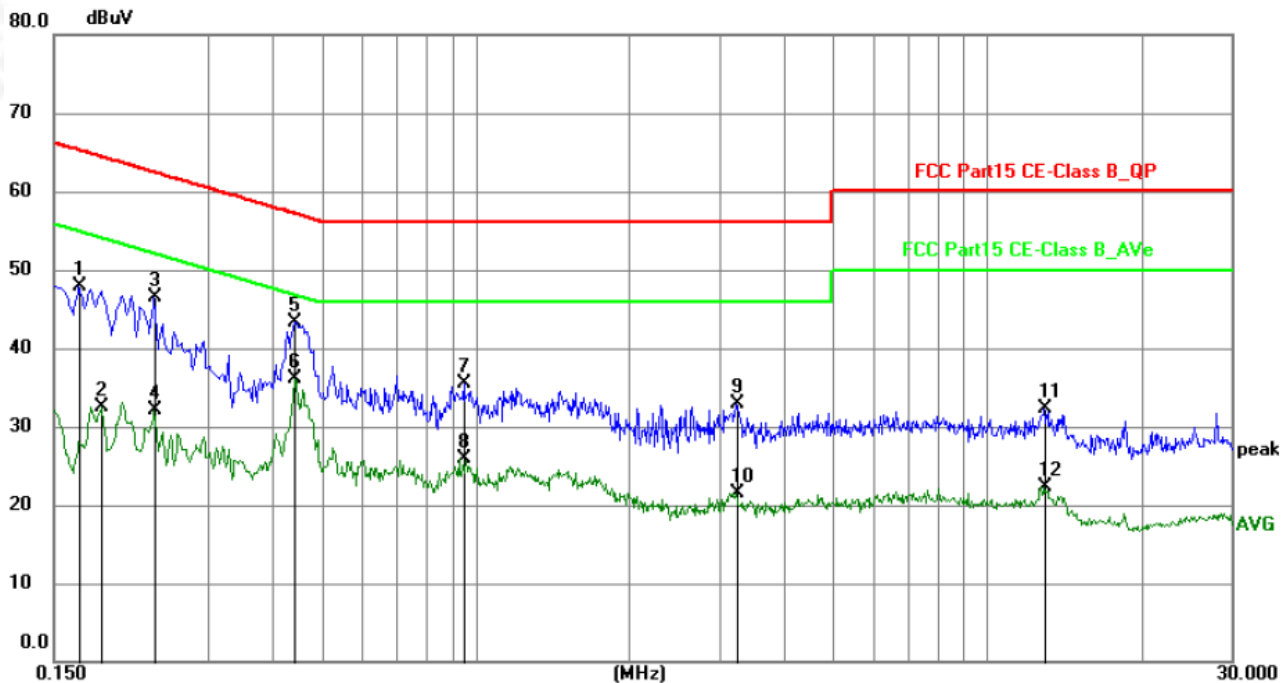

No.	Frequency (MHz)	Reading (dBuV)	Factor (dB)	Level (dBuV)	Limit (dBuV)	Margin (dB)	Detector	P/F
1	0.1680	27.04	20.86	47.90	65.06	-17.16	QP	P
2	0.1860	11.57	20.92	32.49	54.21	-21.72	AVG	P
3	0.2355	25.64	20.93	46.57	62.25	-15.68	QP	P
4	0.2355	11.08	20.93	32.01	52.25	-20.24	AVG	P
5	0.4425	22.55	20.84	43.39	57.01	-13.62	QP	P
6	0.4425	15.29	20.84	36.13	47.01	-10.88	AVG	P
7	0.9510	14.72	20.78	35.50	56.00	-20.50	QP	P
8	0.9510	5.10	20.78	25.88	46.00	-20.12	AVG	P
9	3.2280	12.11	20.76	32.87	56.00	-23.13	QP	P
10	3.2280	0.83	20.76	21.59	46.00	-24.41	AVG	P
11	12.9300	11.72	20.62	32.34	60.00	-27.66	QP	P
12	12.9300	1.73	20.62	22.35	50.00	-27.65	AVG	P



Temperature:	26°C	Relative Humidity:	54%
Pressure:	101 kPa	Polarization:	N
Test Voltage:	AC 120V/60Hz	Test Mode:	802.11n20 - 5745MHz

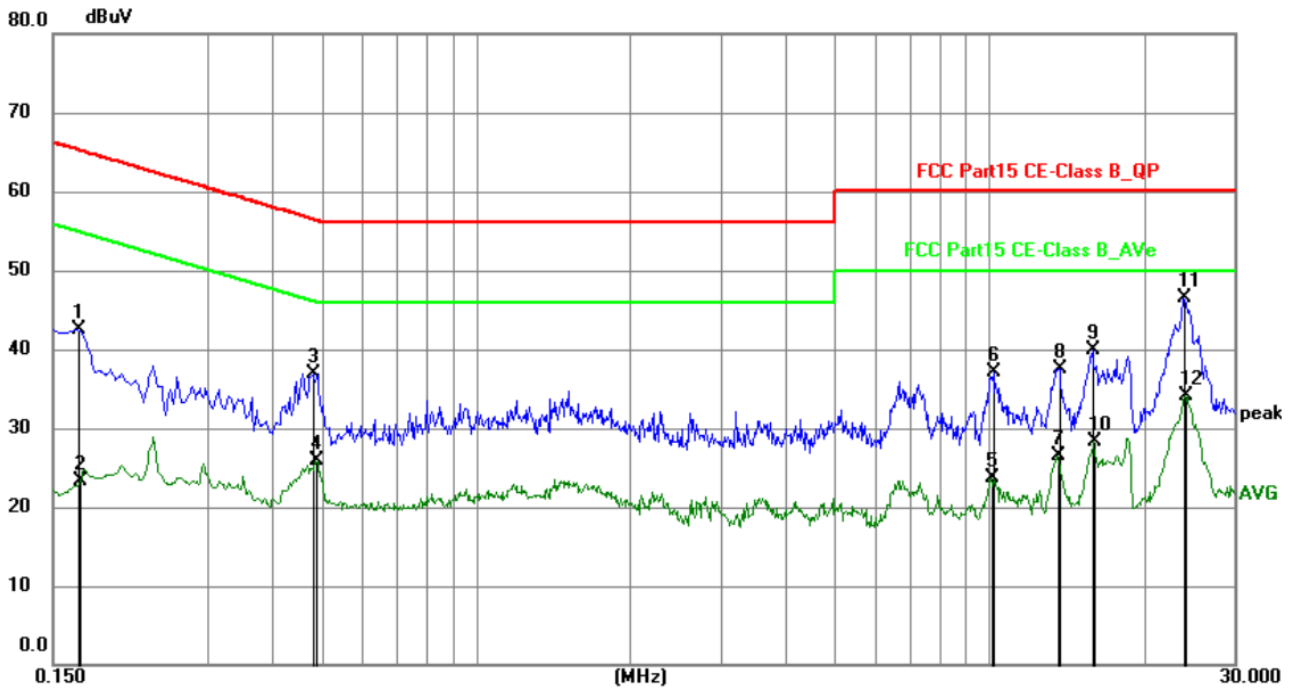

No.	Frequency (MHz)	Reading (dBuV)	Factor (dB)	Level (dBuV)	Limit (dBuV)	Margin (dB)	Detector	P/F	Remark
1	0.1680	21.63	20.90	42.53	65.06	-22.53	QP	P	
2	0.1693	2.49	20.91	23.40	54.99	-31.59	AVG	P	
3	0.4828	16.01	20.86	36.87	56.29	-19.42	QP	P	
4	0.4873	4.98	20.86	25.84	46.21	-20.37	AVG	P	
5	10.1038	1.60	22.07	23.67	50.00	-26.33	AVG	P	
6	10.1983	14.96	22.08	37.04	60.00	-22.96	QP	P	
7	13.5778	3.79	22.66	26.45	50.00	-23.55	AVG	P	
8	13.6859	14.92	22.68	37.60	60.00	-22.40	QP	P	
9	15.9178	16.81	23.07	39.88	60.00	-20.12	QP	P	
10	15.9763	5.27	23.08	28.35	50.00	-21.65	AVG	P	
11	24.0000	22.01	24.40	46.41	60.00	-13.59	QP	P	
12	24.0853	9.74	24.41	34.15	50.00	-15.85	AVG	P	

Notes:

- 1.An initial pre-scan was performed on the line and neutral lines with peak detector.
- 2.Quasi-Peak and Average measurement were performed at the frequencies with maximized peak emission.
- 3.Measurement Level = Reading level + Correct Factor
- 4.The test data shows only the worst case 802.11n20 - 5745MHz.



4.2 RADIATED EMISSION MEASUREMENT

4.2.1 APPLICABLE STANDARD

According to FCC Part 15.407(d) and 15.209

4.2.2 CONFORMANCE LIMIT

According to FCC Part 15.407(b)(7): radiated emissions which fall in the restricted bands, as defined in §15.205(a), must also comply with the radiated emission limits specified in §15.209(a) (see §15.205(c)).

According to FCC Part 15.205, Restricted bands

MHz	MHz	MHz	GHz
0.090-0.110	16.42-16.423	399.9-410	4.5-5.15
10.495-0.505	16.69475-16.69525	608-614	5.35-5.46
2.1735-2.1905	16.80425-16.80475	960-1240	7.25-7.75
4.125-4.128	25.5-25.67	1300-1427	8.025-8.5
4.17725-4.17775	37.5-38.25	1435-1626.5	9.0-9.2
4.20725-4.20775	73-74.6	1645.5-1646.5	9.3-9.5
6.215-6.218	74.8-75.2	1660-1710	10.6-12.7
6.26775-6.26825	123-138	2200-2300	14.47-14.5
8.291-8.294	149.9-150.05	2310-2390	15.35-16.2
8.362-8.366	156.52475-156.52525	2483.5-2500	17.7-21.4
8.37625-8.38675	156.7-156.9	2690-2900	22.01-23.12
8.41425-8.41475	162.0125-167.17	3260-3267	23.6-24.0
12.29-12.293	167.72-173.2	3332-3339	31.2-31.8
12.51975-12.52025	240-285	3345.8-3358	36.43-36.5
12.57675-12.57725	322-335.4	3600-4400	(2)
13.36-13.41			

Restricted Frequency(MHz)	Field Strength (μV/m)	Field Strength (dBμV/m)	Measurement Distance
0.009~0.490	2400/F(KHz)	20 log (uV/m)	300
0.490~1.705	2400/F(KHz)	20 log (uV/m)	30
1.705~30.0	30	29.5	30
30-88	100	40	3
88-216	150	43.5	3
216-960	200	46	3
Above 960	500	54	3

Limits of Radiated Emission Measurement(Above 1000MHz)

Frequency(MHz)	Class B (dBuV/m) (at 3M)	
	PEAK	AVERAGE
Above 1000	74	54

Remark :1. Emission level in dBuV/m=20 log (uV/m)

2. Measurement was performed at an antenna to the closed point of EUT distance of meters.

3. Distance extrapolation factor =40log(Specific distance/ test distance)(dB);

Limit line=Specific limits(dBuV) + distance extrapolation factor.

4.2.3 MEASURING INSTRUMENTS

The Measuring equipment is listed in the section 6.3 of this test report.



4.2.4 TEST CONFIGURATION

1. For radiated emissions below 30MHz

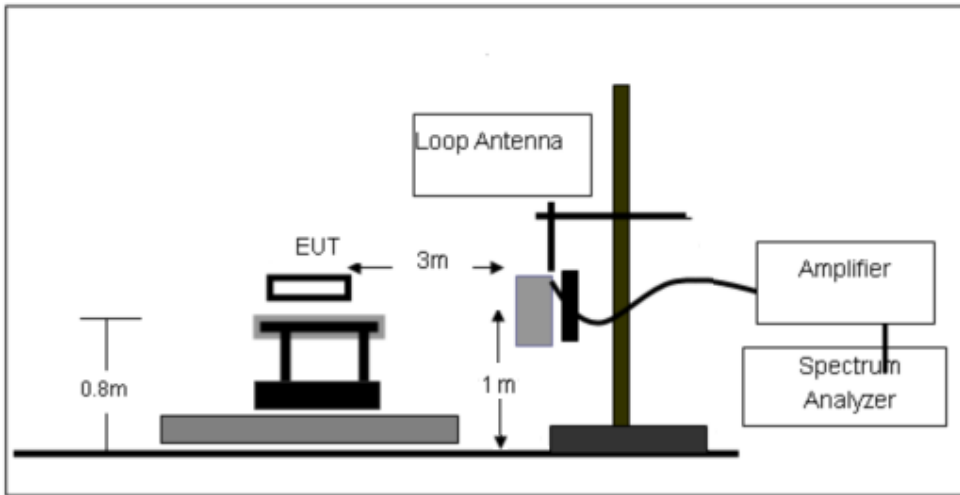

2. For radiated emissions from 30MHz to 1000MHz

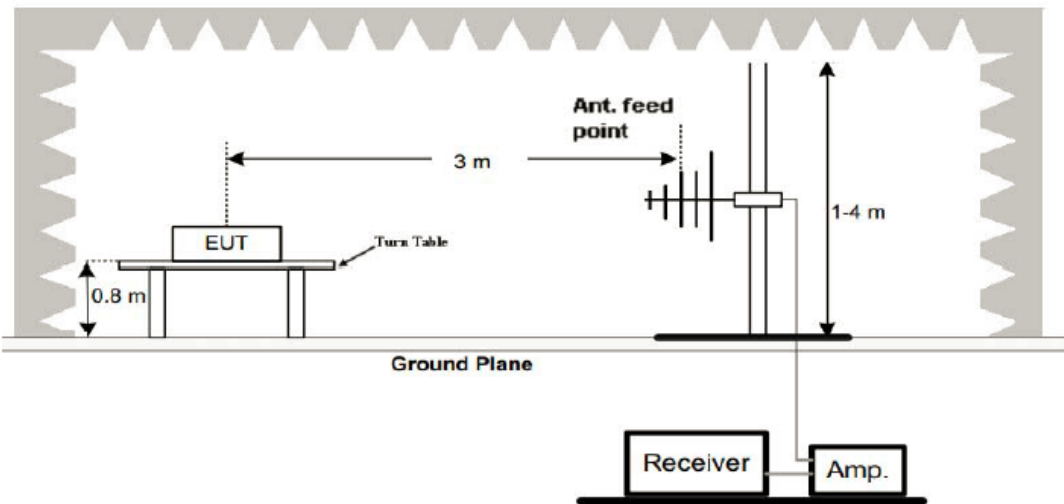

3. Radiated Emission Test-Up Frequency Above 1GHz

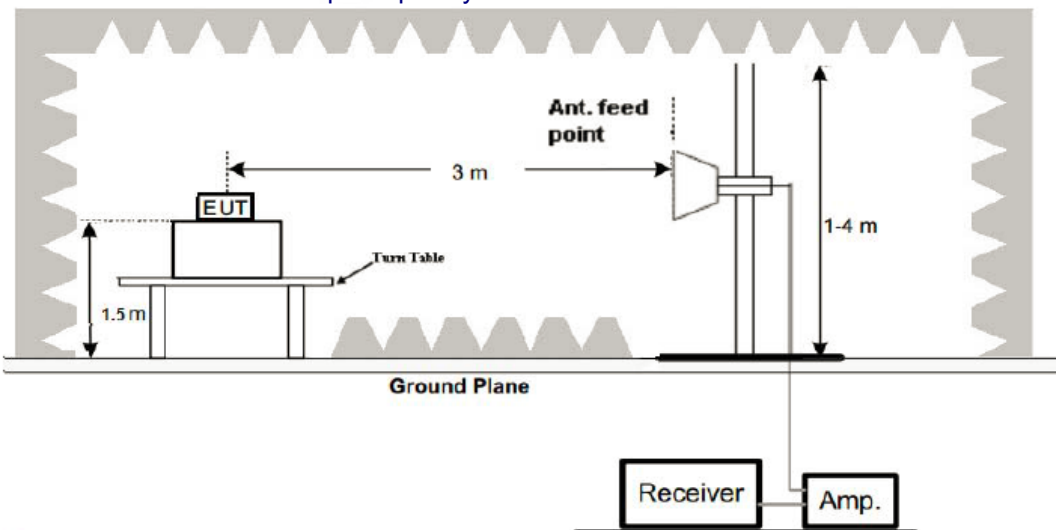



4.2.5 TEST PROCEDURE

The test site semi-anechoic chamber has met the requirement of NSA tolerance 4 dB according to the standards: ANSI C63.10-2013. The test distance is 3m. The setup is according to the requirements in Section 13.1.4.1 of ANSI C63.10-2013 and CAN/CSA-CEI/IEC CISPR 22.

This test is required for any spurious emission that falls in a Restricted Band, as defined in Section 15.205. It must be performed with the highest gain of each type of antenna proposed for use with the EUT. Use the following spectrum analyzer settings:

Spectrum Parameter	Setting
Attenuation	Auto
Start Frequency	1000 MHz
Stop Frequency	10th carrier harmonic
RB / VB (emission in restricted band)	1 MHz / 1 MHz for Peak, 1 MHz / 10Hz for Average

Receiver Parameter	Setting
Attenuation	Auto
Start ~ Stop Frequency	9kHz~150kHz / RB 200Hz for QP
Start ~ Stop Frequency	150kHz~30MHz / RB 9kHz for QP
Start ~ Stop Frequency	30MHz~1000MHz / RB 120kHz for QP

- The measuring distance of at 3 m shall be used for measurements at frequency up to 1GHz. For frequencies above 1GHz, any suitable measuring distance may be used.
- The EUT was placed on the top of a rotating table 0.8 m for below 1GHz and 1.5m for above 1GHz the ground at a 3 meter. The table was rotated 360 degrees to determine the position of the highest radiation.
- The height of the equipment or of the substitution antenna shall be 0.8 m for below 1GHz and 1.5m for above 1GHz; the height of the test antenna shall vary between 1 m to 4 m. Both horizontal and vertical polarizations of the antenna are set to make the measurement.
- The initial step in collecting conducted emission data is a spectrum analyzer peak detector mode pre-scanning the measurement frequency range. Significant peaks are then marked and then Quasi Peak detector mode re-measured.
- If the Peak Mode measured value compliance with and lower than Quasi Peak Mode Limit, the EUT shall be deemed to meet QP Limits and then no additional QP Mode measurement performed.
- For the actual test configuration, please refer to the related Item – EUT Test Photos.

Note:

Both horizontal and vertical antenna polarities were tested and performed pretest to three orthogonal axis. The worst case emissions were reported

During the radiated emission test, the Spectrum Analyzer was set with the following configurations:

Frequency Band (MHz)	Function	Resolution bandwidth	Video Bandwidth
30 to 1000	QP	120 kHz	300 kHz
Above 1000	Peak	1 MHz	1 MHz
	Average	1 MHz	10 Hz

Note: for the frequency ranges below 30 MHz, a narrower RBW is used for these ranges but the measured value should add a RBW correction factor (RBWCF) where $RBWCF [dB] = 10 \cdot \lg(100 [kHz] / \text{narrower RBW [kHz]})$. , the narrower RBW is 1 kHz and RBWCF is 20 dB for the frequency 9 kHz to 150 kHz, and the narrower RBW is 10 kHz and RBWCF is 10 dB for the frequency 150 kHz to 30 MHz.



4.2.6 TEST RESULT

Between 9KHz – 30MHz

The emission from 9 kHz to 30MHz was pre-tested and found the result was 20dB lower than the limit, and according to 15.31(o) & RSS-Gen 6.13, the test result no need to reported.

Between 30MHz – 1GHz

5.2G:

Temperature:	26°C	Relative Humidity:	54%
Pressure:	101 kPa	Polarization:	Horizontal
Test Voltage:	DC 24V	Test Mode :	TX 802.11n20 - 5180MHz

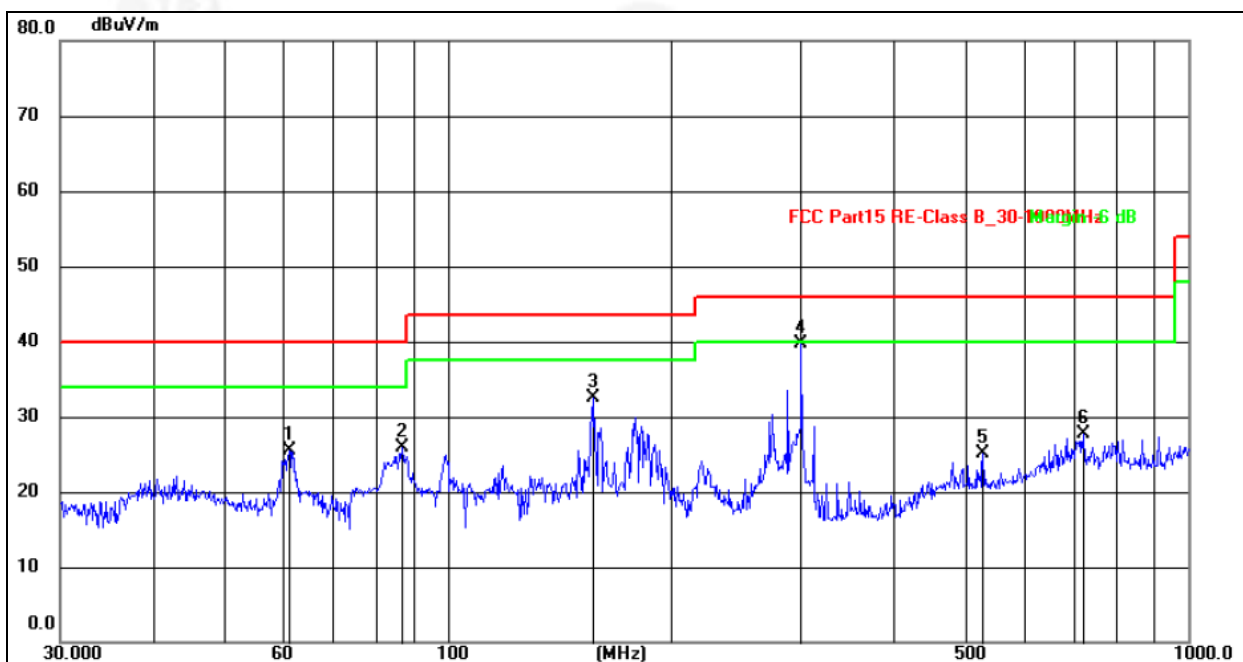

No.	Frequency (MHz)	Reading (dBuV)	Factor (dB/m)	Level (dBuV/m)	Limit (dBuV/m)	Margin (dB)	Detector
1	61.1315	40.10	-14.53	25.57	40.00	-14.43	QP
2	86.8067	45.84	-19.96	25.88	40.00	-14.12	QP
3	157.5586	48.69	-16.28	32.41	43.50	-11.09	QP
4	300.3672	56.77	-16.98	39.79	46.00	-6.21	QP
5	528.2458	35.95	-10.83	25.12	46.00	-20.88	QP
6	721.7258	34.41	-6.76	27.65	46.00	-18.35	QP



Temperature:	26°C	Relative Humidity:	54%
Pressure:	101kPa	Polarization:	Vertical
Test Voltage:	DC 24V	Test Mode :	TX 802.11n20 - 5180MHz

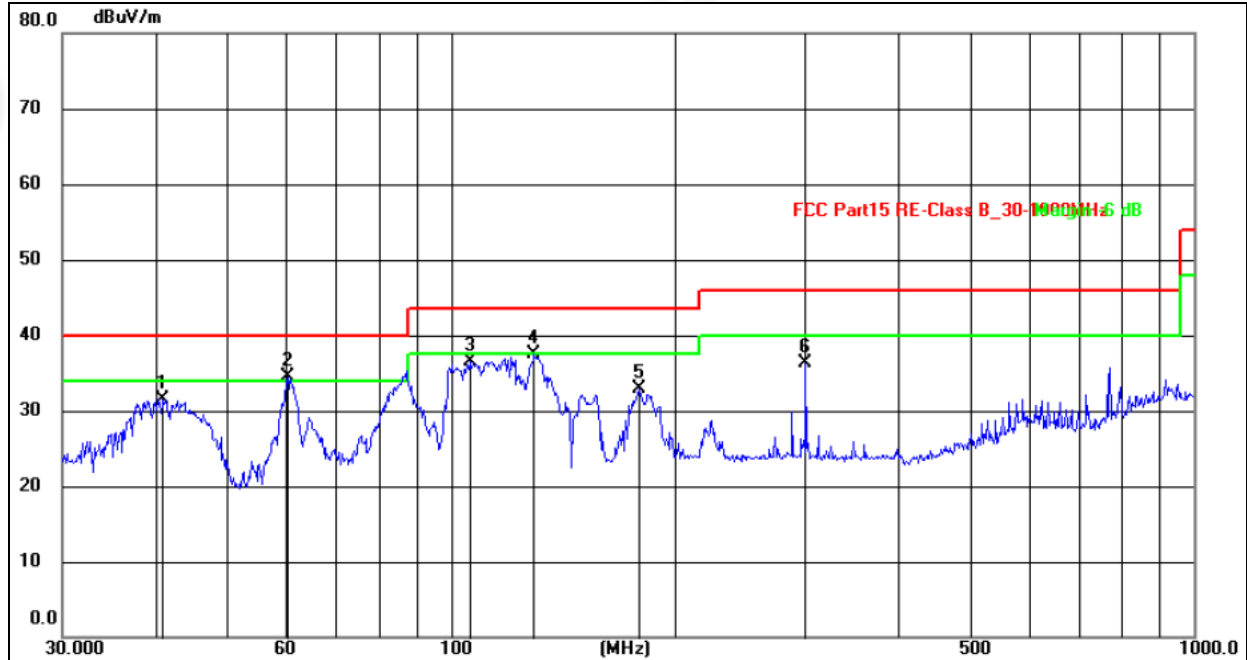

No.	Frequency (MHz)	Reading (dBuV)	Factor (dB/m)	Level (dBuV/m)	Limit (dBuV/m)	Margin (dB)	Detector
1	40.9879	48.48	-16.90	31.58	40.00	-8.42	QP
2	60.2800	52.86	-18.34	34.52	40.00	-5.48	QP
3	106.0126	57.79	-21.26	36.53	43.50	-6.97	QP
4	129.4677	58.64	-21.16	37.48	43.50	-6.02	QP
5	179.3863	52.66	-19.85	32.81	43.50	-10.69	QP
6	300.3672	54.57	-18.32	36.25	46.00	-9.75	QP

Remarks:

- 1.Final Level =Receiver Read level + Antenna Factor + Cable Loss – Preamplifier Factor
- 2.The emission levels of other frequencies are very lower than the limit and not show in test report.
- 3.All modes were tested, and only the worst test data was recorded is 802.11n20 - 5180MHz.



5.8G:

Temperature:	26°C	Relative Humidity:	54%
Pressure:	101 kPa	Polarization:	Horizontal
Test Voltage:	DC 24V	Test Mode :	TX 802.11n20 - 5745MHz

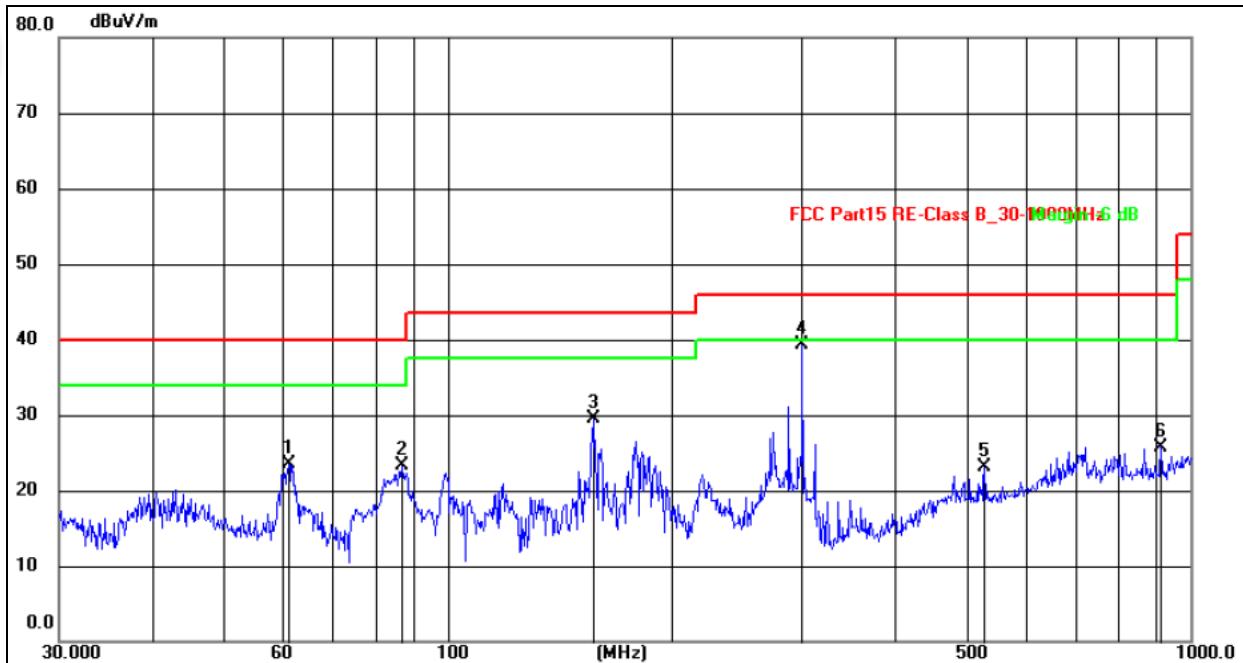

No.	Frequency (MHz)	Reading (dBuV)	Factor (dB/m)	Level (dBuV/m)	Limit (dBuV/m)	Margin (dB)	Detector
1	61.1315	38.10	-14.53	23.57	40.00	-16.43	QP
2	86.8067	43.34	-19.96	23.38	40.00	-16.62	QP
3	157.5586	45.69	-16.28	29.41	43.50	-14.09	QP
4	300.3672	56.27	-16.98	39.29	46.00	-6.71	QP
5	528.2458	33.95	-10.83	23.12	46.00	-22.88	QP
6	912.8618	32.52	-6.72	25.80	46.00	-20.20	QP



Temperature:	26°C	Relative Humidity:	54%
Pressure:	101kPa	Polarization:	Vertical
Test Voltage:	DC 24V	Test Mode :	TX 802.11n20 - 5745MHz

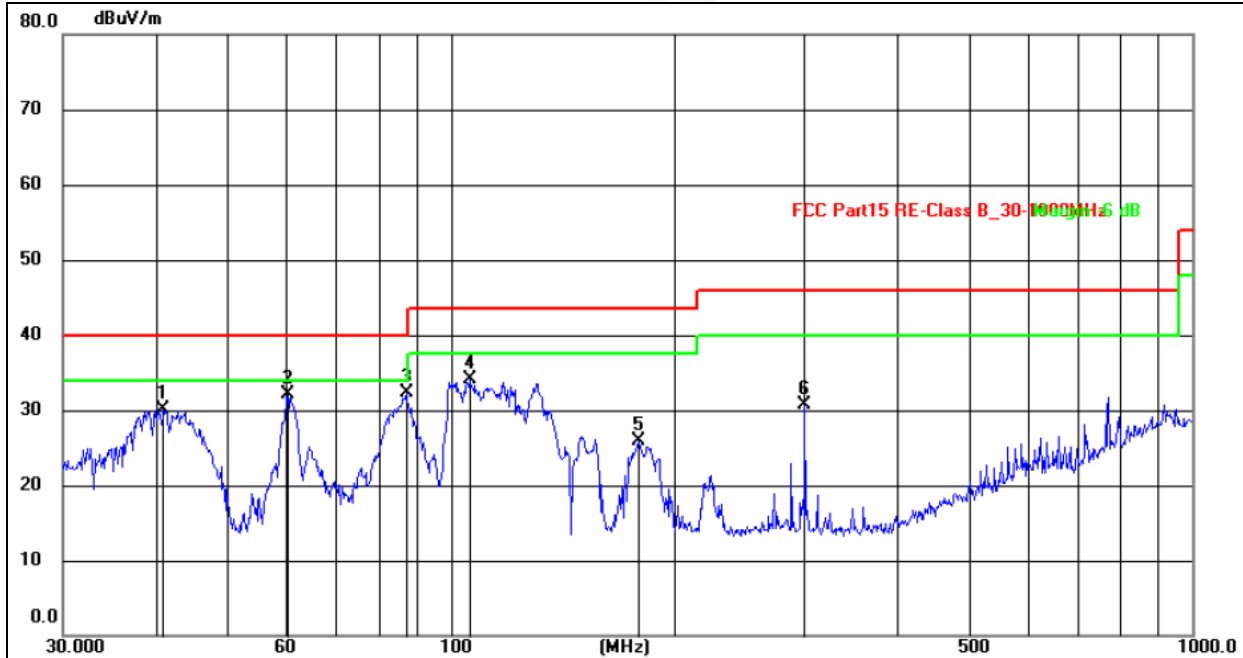

No.	Frequency (MHz)	Reading (dBuV)	Factor (dB/m)	Level (dBuV/m)	Limit (dBuV/m)	Margin (dB)	Detector
1	40.9879	46.98	-16.90	30.08	40.00	-9.92	QP
2	60.2800	50.36	-18.34	32.02	40.00	-7.98	QP
3	87.1115	53.96	-21.61	32.35	40.00	-7.65	QP
4	106.0126	55.29	-21.26	34.03	43.50	-9.47	QP
5	179.3863	45.66	-19.85	25.81	43.50	-17.69	QP
6	300.3672	49.07	-18.32	30.75	46.00	-15.25	QP

Remarks:

- 1.Final Level =Receiver Read level + Antenna Factor + Cable Loss – Preamplifier Factor
- 2.The emission levels of other frequencies are very lower than the limit and not show in test report.
- 3.All modes were tested, and only the worst test data was recorded is 802.11n20 - 5745MHz.



Between 1GHz – 40GHz

Temperature :	26°C	Relative Humidity :	54%
Pressure :	1010 hPa	Test Voltage :	DC 24V
Test Mode :	5.2G TX - 802.11a/ n20/ ac20/ n40/ ac40/ac80		
Note: All patterns have been tested, and only the worst test data recorded in this report is 802.11a/n20/ac20.			

802.11a

Polar (H/V)	Frequency	Meter Reading	Pre-amplifier	Cable Loss	Antenna Factor	Emission Level	Limits	Margin	Detect or Type
	(MHz)	(dBuV)	(dB)	(dB)	(dB)	(dBuV/m)	(dBuV/m)	(dB)	
Low Channel:5180MHz									
V	5150.00	41.66	30.45	8.77	38.66	58.64	74.00	-15.36	PK
V	5150.00	31.54	30.45	8.77	38.66	48.52	54.00	-5.48	AV
V	10360.00	52.14	30.55	5.77	24.66	52.02	74.00	-21.98	PK
V	10360.00	42.99	30.55	5.77	24.66	42.87	54.00	-11.13	AV
V	15540.00	53.77	30.33	6.32	24.55	54.31	74.00	-19.69	PK
V	15540.00	42.88	30.33	6.32	24.55	43.42	54.00	-10.58	AV
V	20720.00	49.66	30.85	7.45	24.69	50.95	74.00	-23.05	PK
V	20720.00	42.91	30.85	7.45	24.69	44.20	54.00	-9.80	AV
V	25900.00	51.55	31.02	8.99	25.57	55.09	74.00	-18.91	PK
V	25900.00	42.75	31.02	8.99	25.57	46.29	54.00	-7.71	AV
H	5150.00	41.58	30.45	8.77	38.66	58.56	74.00	-15.44	PK
H	5150.00	31.69	30.45	8.77	38.66	48.67	54.00	-5.33	AV
H	10360.00	50.15	30.55	5.77	24.66	50.03	74.00	-23.97	PK
H	10360.00	42.44	30.55	5.77	24.66	42.32	54.00	-11.68	AV
H	15540.00	53.15	30.33	6.32	24.55	53.69	74.00	-20.31	PK
H	15540.00	42.99	30.33	6.32	24.55	43.53	54.00	-10.47	AV
H	20720.00	51.14	30.85	7.45	24.69	52.43	74.00	-21.57	PK
H	20720.00	43.04	30.85	7.45	24.69	44.33	54.00	-9.67	AV
H	25900.00	50.15	31.02	8.99	25.57	53.69	74.00	-20.31	PK
H	25900.00	42.83	31.02	8.99	25.57	46.37	54.00	-7.63	AV

Polar (H/V)	Frequency	Meter Reading	Pre-amplifier	Cable Loss	Antenna Factor	Emission Level	Limits	Margin	Detect or Type
	(MHz)	(dBuV)	(dB)	(dB)	(dB)	(dBuV/m)	(dBuV/m)	(dB)	
Middle Channel:5200MHz									
V	5150.00	40.33	30.45	8.77	38.66	57.31	74.00	-16.69	PK
V	5150.00	29.89	30.45	8.77	38.66	46.87	54.00	-7.13	AV
V	10400.00	50.33	30.55	5.77	24.66	50.21	74.00	-23.79	PK
V	10400.00	41.17	30.55	5.77	24.66	41.05	54.00	-12.95	AV
V	15600.00	51.91	30.33	6.32	24.55	52.45	74.00	-21.55	PK
V	15600.00	40.62	30.33	6.32	24.55	41.16	54.00	-12.84	AV
V	20800.00	47.73	30.85	7.45	24.69	49.02	74.00	-24.98	PK
V	20800.00	40.84	30.85	7.45	24.69	42.13	54.00	-11.87	AV
V	26000.00	49.76	31.02	8.99	25.57	53.30	74.00	-20.70	PK
V	26000.00	40.73	31.02	8.99	25.57	44.27	54.00	-9.73	AV
H	5150.00	39.85	30.45	8.77	38.66	56.83	74.00	-17.17	PK
H	5150.00	29.90	30.45	8.77	38.66	46.88	54.00	-7.12	AV
H	10400.00	47.94	30.55	5.77	24.66	47.82	74.00	-26.18	PK
H	10400.00	40.73	30.55	5.77	24.66	40.61	54.00	-13.39	AV
H	15600.00	50.80	30.33	6.32	24.55	51.34	74.00	-22.66	PK



H	15600.00	40.89	30.33	6.32	24.55	41.43	54.00	-12.57	AV
H	20800.00	49.06	30.85	7.45	24.69	50.35	74.00	-23.65	PK
H	20800.00	41.34	30.85	7.45	24.69	42.63	54.00	-11.37	AV
H	26000.00	48.43	31.02	8.99	25.57	51.97	74.00	-22.03	PK
H	26000.00	41.24	31.02	8.99	25.57	44.78	54.00	-9.22	AV

Polar (H/V)	Frequency	Meter Reading	Pre-amplifier	Cable Loss	Antenna Factor	Emission Level	Limits	Margin	Detect or Type
	(MHz)	(dBuV)	(dB)	(dB)	(dB)	(dBuV/m)	(dBuV/m)	(dB)	
High Channel:5240MHz									
V	5350.00	40.63	30.45	8.77	38.66	57.61	74.00	-16.39	PK
V	5350.00	30.98	30.45	8.77	38.66	47.96	54.00	-6.04	AV
V	10480.00	50.89	30.55	5.77	24.66	50.77	74.00	-23.23	PK
V	10480.00	41.60	30.55	5.77	24.66	41.48	54.00	-12.52	AV
V	15720.00	52.78	30.33	6.32	24.55	53.32	74.00	-20.68	PK
V	15720.00	42.09	30.33	6.32	24.55	42.63	54.00	-11.37	AV
V	20960.00	48.61	30.85	7.45	24.69	49.90	74.00	-24.10	PK
V	20960.00	41.56	30.85	7.45	24.69	42.85	54.00	-11.15	AV
V	26200.00	50.86	31.02	8.99	25.57	54.40	74.00	-19.60	PK
V	26200.00	41.55	31.02	8.99	25.57	45.09	54.00	-8.91	AV
H	5350.00	40.65	30.45	8.77	38.66	57.63	74.00	-16.37	PK
H	5350.00	31.09	30.45	8.77	38.66	48.07	54.00	-5.93	AV
H	10480.00	48.90	30.55	5.77	24.66	48.78	74.00	-25.22	PK
H	10480.00	42.02	30.55	5.77	24.66	41.90	54.00	-12.10	AV
H	15720.00	51.57	30.33	6.32	24.55	52.11	74.00	-21.89	PK
H	15720.00	41.46	30.33	6.32	24.55	42.00	54.00	-12.00	AV
H	20960.00	49.92	30.85	7.45	24.69	51.21	74.00	-22.79	PK
H	20960.00	42.11	30.85	7.45	24.69	43.40	54.00	-10.60	AV
H	26200.00	49.10	31.02	8.99	25.57	52.64	74.00	-21.36	PK
H	26200.00	42.17	31.02	8.99	25.57	45.71	54.00	-8.29	AV

Remark:

1. Emission Level = Meter Reading + Antenna Factor + Cable Loss – Pre-amplifier, Margin= Emission Level - Limit
2. If peak below the average limit, the average emission was no test.
3. The amplitude of spurious emissions which are attenuated by more than 20dB below the permissible value has no need to be reported.



802.11n20

Polar (H/V)	Frequency	Meter Reading	Pre-amplifier	Cable Loss	Antenna Factor	Emission Level	Limits	Margin	Detect or Type
	(MHz)	(dBuV)	(dB)	(dB)	(dB)	(dBuV/m)	(dBuV/m)	(dB)	
Low Channel:5180MHz									
V	5150.00	42.01	30.45	8.77	38.66	58.99	74.00	-15.01	PK
V	5150.00	31.89	30.45	8.77	38.66	48.87	54.00	-5.13	AV
V	10360.00	52.49	30.55	5.77	24.66	52.37	74.00	-21.63	PK
V	10360.00	43.34	30.55	5.77	24.66	43.22	54.00	-10.78	AV
V	15540.00	54.12	30.33	6.32	24.55	54.66	74.00	-19.34	PK
V	15540.00	43.23	30.33	6.32	24.55	43.77	54.00	-10.23	AV
V	20720.00	50.01	30.85	7.45	24.69	51.30	74.00	-22.70	PK
V	20720.00	43.26	30.85	7.45	24.69	44.55	54.00	-9.45	AV
V	25900.00	51.90	31.02	8.99	25.57	55.44	74.00	-18.56	PK
V	25900.00	43.10	31.02	8.99	25.57	46.64	54.00	-7.36	AV
H	5150.00	41.93	30.45	8.77	38.66	58.91	74.00	-15.09	PK
H	5150.00	32.04	30.45	8.77	38.66	49.02	54.00	-4.98	AV
H	10360.00	50.50	30.55	5.77	24.66	50.38	74.00	-23.62	PK
H	10360.00	42.79	30.55	5.77	24.66	42.67	54.00	-11.33	AV
H	15540.00	53.50	30.33	6.32	24.55	54.04	74.00	-19.96	PK
H	15540.00	43.34	30.33	6.32	24.55	43.88	54.00	-10.12	AV
H	20720.00	51.49	30.85	7.45	24.69	52.78	74.00	-21.22	PK
H	20720.00	43.39	30.85	7.45	24.69	44.68	54.00	-9.32	AV
H	25900.00	50.50	31.02	8.99	25.57	54.04	74.00	-19.96	PK
H	25900.00	43.18	31.02	8.99	25.57	46.72	54.00	-7.28	AV

Polar (H/V)	Frequency	Meter Reading	Pre-amplifier	Cable Loss	Antenna Factor	Emission Level	Limits	Margin	Detect or Type
	(MHz)	(dBuV)	(dB)	(dB)	(dB)	(dBuV/m)	(dBuV/m)	(dB)	
Middle Channel:5200MHz									
V	5150.00	41.59	30.45	8.77	38.66	58.57	74.00	-15.43	PK
V	5150.00	31.15	30.45	8.77	38.66	48.13	54.00	-5.87	AV
V	10400.00	51.59	30.55	5.77	24.66	51.47	74.00	-22.53	PK
V	10400.00	42.43	30.55	5.77	24.66	42.31	54.00	-11.69	AV
V	15600.00	53.17	30.33	6.32	24.55	53.71	74.00	-20.29	PK
V	15600.00	41.88	30.33	6.32	24.55	42.42	54.00	-11.58	AV
V	20800.00	48.99	30.85	7.45	24.69	50.28	74.00	-23.72	PK
V	20800.00	42.10	30.85	7.45	24.69	43.39	54.00	-10.61	AV
V	26000.00	51.02	31.02	8.99	25.57	54.56	74.00	-19.44	PK
V	26000.00	41.99	31.02	8.99	25.57	45.53	54.00	-8.47	AV
H	5150.00	41.11	30.45	8.77	38.66	58.09	74.00	-15.91	PK
H	5150.00	31.16	30.45	8.77	38.66	48.14	54.00	-5.86	AV
H	10400.00	49.20	30.55	5.77	24.66	49.08	74.00	-24.92	PK
H	10400.00	41.99	30.55	5.77	24.66	41.87	54.00	-12.13	AV
H	15600.00	52.06	30.33	6.32	24.55	52.60	74.00	-21.40	PK
H	15600.00	42.15	30.33	6.32	24.55	42.69	54.00	-11.31	AV
H	20800.00	50.32	30.85	7.45	24.69	51.61	74.00	-22.39	PK
H	20800.00	42.60	30.85	7.45	24.69	43.89	54.00	-10.11	AV
H	26000.00	49.69	31.02	8.99	25.57	53.23	74.00	-20.77	PK
H	26000.00	42.50	31.02	8.99	25.57	46.04	54.00	-7.96	AV



Polar (H/V)	Frequency	Meter Reading	Pre-ampli fier	Cable Loss	Antenna Factor	Emission Level	Limits	Margin	Detect or Type
	(MHz)	(dBuV)	(dB)	(dB)	(dB)	(dBuV/m)	(dBuV/ m)	(dB)	
High Channel:5240MHz									
V	5350.00	40.83	30.45	8.77	38.66	57.81	74.00	-16.19	PK
V	5350.00	31.18	30.45	8.77	38.66	48.16	54.00	-5.84	AV
V	10480.00	51.09	30.55	5.77	24.66	50.97	74.00	-23.03	PK
V	10480.00	41.80	30.55	5.77	24.66	41.68	54.00	-12.32	AV
V	15720.00	52.98	30.33	6.32	24.55	53.52	74.00	-20.48	PK
V	15720.00	42.29	30.33	6.32	24.55	42.83	54.00	-11.17	AV
V	20960.00	48.81	30.85	7.45	24.69	50.10	74.00	-23.90	PK
V	20960.00	41.76	30.85	7.45	24.69	43.05	54.00	-10.95	AV
V	26200.00	51.06	31.02	8.99	25.57	54.60	74.00	-19.40	PK
V	26200.00	41.75	31.02	8.99	25.57	45.29	54.00	-8.71	AV
H	5350.00	40.85	30.45	8.77	38.66	57.83	74.00	-16.17	PK
H	5350.00	31.29	30.45	8.77	38.66	48.27	54.00	-5.73	AV
H	10480.00	49.10	30.55	5.77	24.66	48.98	74.00	-25.02	PK
H	10480.00	42.22	30.55	5.77	24.66	42.10	54.00	-11.90	AV
H	15720.00	51.77	30.33	6.32	24.55	52.31	74.00	-21.69	PK
H	15720.00	41.66	30.33	6.32	24.55	42.20	54.00	-11.80	AV
H	20960.00	50.12	30.85	7.45	24.69	51.41	74.00	-22.59	PK
H	20960.00	42.31	30.85	7.45	24.69	43.60	54.00	-10.40	AV
H	26200.00	49.30	31.02	8.99	25.57	52.84	74.00	-21.16	PK
H	26200.00	42.37	31.02	8.99	25.57	45.91	54.00	-8.09	AV

Remark:

1. Emission Level = Meter Reading + Antenna Factor + Cable Loss – Pre-amplifier, Margin= Emission Level - Limit
2. If peak below the average limit, the average emission was no test.
3. The amplitude of spurious emissions which are attenuated by more than 20dB below the permissible value has no need to be reported.



802.11ac20

Polar (H/V)	Frequency	Meter Reading	Pre-amplifier	Cable Loss	Antenna Factor	Emission Level	Limits	Margin	Detect or Type
	(MHz)	(dBuV)	(dB)	(dB)	(dB)	(dBuV/m)	(dBuV/m)	(dB)	
Low Channel:5180MHz									
V	5150.00	41.83	30.45	8.77	38.66	58.81	74.00	-15.19	PK
V	5150.00	31.71	30.45	8.77	38.66	48.69	54.00	-5.31	AV
V	10360.00	52.31	30.55	5.77	24.66	52.19	74.00	-21.81	PK
V	10360.00	43.16	30.55	5.77	24.66	43.04	54.00	-10.96	AV
V	15540.00	53.94	30.33	6.32	24.55	54.48	74.00	-19.52	PK
V	15540.00	43.05	30.33	6.32	24.55	43.59	54.00	-10.41	AV
V	20720.00	49.83	30.85	7.45	24.69	51.12	74.00	-22.88	PK
V	20720.00	43.08	30.85	7.45	24.69	44.37	54.00	-9.63	AV
V	25900.00	51.72	31.02	8.99	25.57	55.26	74.00	-18.74	PK
V	25900.00	42.92	31.02	8.99	25.57	46.46	54.00	-7.54	AV
H	5150.00	41.75	30.45	8.77	38.66	58.73	74.00	-15.27	PK
H	5150.00	31.86	30.45	8.77	38.66	48.84	54.00	-5.16	AV
H	10360.00	50.32	30.55	5.77	24.66	50.20	74.00	-23.80	PK
H	10360.00	42.61	30.55	5.77	24.66	42.49	54.00	-11.51	AV
H	15540.00	53.32	30.33	6.32	24.55	53.86	74.00	-20.14	PK
H	15540.00	43.16	30.33	6.32	24.55	43.70	54.00	-10.30	AV
H	20720.00	51.31	30.85	7.45	24.69	52.60	74.00	-21.40	PK
H	20720.00	43.21	30.85	7.45	24.69	44.50	54.00	-9.50	AV
H	25900.00	50.32	31.02	8.99	25.57	53.86	74.00	-20.14	PK
H	25900.00	43.00	31.02	8.99	25.57	46.54	54.00	-7.46	AV

Polar (H/V)	Frequency	Meter Reading	Pre-amplifier	Cable Loss	Antenna Factor	Emission Level	Limits	Margin	Detect or Type
	(MHz)	(dBuV)	(dB)	(dB)	(dB)	(dBuV/m)	(dBuV/m)	(dB)	
Middle Channel:5200MHz									
V	5150.00	40.72	30.45	8.77	38.66	57.70	74.00	-16.30	PK
V	5150.00	30.28	30.45	8.77	38.66	47.26	54.00	-6.74	AV
V	10400.00	50.72	30.55	5.77	24.66	50.60	74.00	-23.40	PK
V	10400.00	41.56	30.55	5.77	24.66	41.44	54.00	-12.56	AV
V	15600.00	52.30	30.33	6.32	24.55	52.84	74.00	-21.16	PK
V	15600.00	41.01	30.33	6.32	24.55	41.55	54.00	-12.45	AV
V	20800.00	48.12	30.85	7.45	24.69	49.41	74.00	-24.59	PK
V	20800.00	41.23	30.85	7.45	24.69	42.52	54.00	-11.48	AV
V	26000.00	50.15	31.02	8.99	25.57	53.69	74.00	-20.31	PK
V	26000.00	41.12	31.02	8.99	25.57	44.66	54.00	-9.34	AV
H	5150.00	40.24	30.45	8.77	38.66	57.22	74.00	-16.78	PK
H	5150.00	30.29	30.45	8.77	38.66	47.27	54.00	-6.73	AV
H	10400.00	48.33	30.55	5.77	24.66	48.21	74.00	-25.79	PK
H	10400.00	41.12	30.55	5.77	24.66	41.00	54.00	-13.00	AV
H	15600.00	51.19	30.33	6.32	24.55	51.73	74.00	-22.27	PK
H	15600.00	41.28	30.33	6.32	24.55	41.82	54.00	-12.18	AV
H	20800.00	49.45	30.85	7.45	24.69	50.74	74.00	-23.26	PK
H	20800.00	41.73	30.85	7.45	24.69	43.02	54.00	-10.98	AV
H	26000.00	48.82	31.02	8.99	25.57	52.36	74.00	-21.64	PK
H	26000.00	41.63	31.02	8.99	25.57	45.17	54.00	-8.83	AV



Polar (H/V)	Frequency	Meter Reading	Pre-ampli fier	Cable Loss	Antenna Factor	Emission Level	Limits	Margin	Detect or Type
	(MHz)	(dBuV)	(dB)	(dB)	(dB)	(dBuV/m)	(dBuV/ m)	(dB)	
High Channel:5240MHz									
V	5350.00	40.70	30.45	8.77	38.66	57.68	74.00	-16.32	PK
V	5350.00	31.05	30.45	8.77	38.66	48.03	54.00	-5.97	AV
V	10480.00	50.96	30.55	5.77	24.66	50.84	74.00	-23.16	PK
V	10480.00	41.67	30.55	5.77	24.66	41.55	54.00	-12.45	AV
V	15720.00	52.85	30.33	6.32	24.55	53.39	74.00	-20.61	PK
V	15720.00	42.16	30.33	6.32	24.55	42.70	54.00	-11.30	AV
V	20960.00	48.68	30.85	7.45	24.69	49.97	74.00	-24.03	PK
V	20960.00	41.63	30.85	7.45	24.69	42.92	54.00	-11.08	AV
V	26200.00	50.93	31.02	8.99	25.57	54.47	74.00	-19.53	PK
V	26200.00	41.62	31.02	8.99	25.57	45.16	54.00	-8.84	AV
H	5350.00	40.72	30.45	8.77	38.66	57.70	74.00	-16.30	PK
H	5350.00	31.16	30.45	8.77	38.66	48.14	54.00	-5.86	AV
H	10480.00	48.97	30.55	5.77	24.66	48.85	74.00	-25.15	PK
H	10480.00	42.09	30.55	5.77	24.66	41.97	54.00	-12.03	AV
H	15720.00	51.64	30.33	6.32	24.55	52.18	74.00	-21.82	PK
H	15720.00	41.53	30.33	6.32	24.55	42.07	54.00	-11.93	AV
H	20960.00	49.99	30.85	7.45	24.69	51.28	74.00	-22.72	PK
H	20960.00	42.18	30.85	7.45	24.69	43.47	54.00	-10.53	AV
H	26200.00	49.17	31.02	8.99	25.57	52.71	74.00	-21.29	PK
H	26200.00	42.24	31.02	8.99	25.57	45.78	54.00	-8.22	AV

Remark:

1. Emission Level = Meter Reading + Antenna Factor + Cable Loss – Pre-amplifier, Margin= Emission Level - Limit
2. If peak below the average limit, the average emission was no test.
3. The amplitude of spurious emissions which are attenuated by more than 20dB below the permissible value has no need to be reported.



Temperature :	26°C	Relative Humidity :	54%
Pressure :	1010 hPa	Test Voltage :	DC 24V
Test Mode :	5.8G TX - 802.11a/ n20/ ac20/ n40/ ac40/ac80		
Note: All patterns have been tested, and only the worst test data recorded in this report is 802.11a/n20/ac20.			

802.11a

Polar (H/V)	Frequency	Meter Reading	Pre-amplifier	Cable Loss	Antenna Factor	Emission Level	Limits	Margin	Detect or Type
	(MHz)	(dBuV)	(dB)	(dB)	(dB)	(dBuV/m)	(dBuV/m)	(dB)	
Low Channel:5745MHz									
V	11490.00	50.21	30.55	5.77	24.66	50.09	74.00	-23.91	PK
V	11490.00	42.49	30.55	5.77	24.66	42.37	54.00	-11.63	AV
V	17235.00	51.48	30.33	6.32	24.55	52.02	68.20	-16.18	PK
V	17235.00	42.01	30.33	6.32	24.55	42.55	54.00	-11.45	AV
V	22980.00	49.09	30.85	7.45	24.69	50.38	74.00	-23.62	PK
V	22980.00	41.94	30.85	7.45	24.69	43.23	54.00	-10.77	AV
V	28725.00	52.34	31.02	8.99	25.57	55.88	68.20	-12.32	PK
V	28725.00	42.16	31.02	8.99	25.57	45.70	54.00	-8.30	AV
H	11490.00	50.96	30.55	5.77	24.66	50.84	74.00	-23.16	PK
H	11490.00	42.46	30.55	5.77	24.66	42.34	54.00	-11.66	AV
H	17235.00	52.97	30.33	6.32	24.55	53.51	68.20	-14.69	PK
H	17235.00	42.17	30.33	6.32	24.55	42.71	54.00	-11.29	AV
H	22980.00	50.93	30.85	7.45	24.69	52.22	74.00	-21.78	PK
H	22980.00	42.40	30.85	7.45	24.69	43.69	54.00	-10.31	AV
H	28725.00	51.52	31.02	8.99	25.57	55.06	68.20	-13.14	PK
H	28725.00	42.63	31.02	8.99	25.57	46.17	54.00	-7.83	AV

Polar (H/V)	Frequency	Meter Reading	Pre-amplifier	Cable Loss	Antenna Factor	Emission Level	Limits	Margin	Detect or Type
	(MHz)	(dBuV)	(dB)	(dB)	(dB)	(dBuV/m)	(dBuV/m)	(dB)	
Middle Channel:5785MHz									
V	11570.00	50.36	30.55	5.77	24.66	50.24	74.00	-23.76	PK
V	11570.00	42.75	30.55	5.77	24.66	42.63	54.00	-11.37	AV
V	17355.00	49.50	30.33	6.32	24.55	50.04	68.20	-18.16	PK
V	17355.00	42.55	30.33	6.32	24.55	43.09	54.00	-10.91	AV
V	23140.00	51.58	30.85	7.45	24.69	52.87	68.20	-15.33	PK
V	23140.00	42.36	30.85	7.45	24.69	43.65	54.00	-10.35	AV
V	28925.00	49.53	31.02	8.99	25.57	53.07	68.20	-15.13	PK
V	28925.00	42.58	31.02	8.99	25.57	46.12	54.00	-7.88	AV
H	11570.00	49.71	30.55	5.77	24.66	49.59	74.00	-24.41	PK
H	11570.00	42.83	30.55	5.77	24.66	42.71	54.00	-11.29	AV
H	17355.00	53.94	30.33	6.32	24.55	54.48	68.20	-13.72	PK
H	17355.00	42.36	30.33	6.32	24.55	42.90	54.00	-11.10	AV
H	23140.00	51.45	30.85	7.45	24.69	52.74	68.20	-15.46	PK
H	23140.00	42.77	30.85	7.45	24.69	44.06	54.00	-9.94	AV
H	28925.00	49.35	31.02	8.99	25.57	52.89	68.20	-15.31	PK
H	28925.00	42.95	31.02	8.99	25.57	46.49	54.00	-7.51	AV



Polar (H/V)	Frequency	Meter Reading	Pre-ampli fier	Cable Loss	Antenna Factor	Emission Level	Limits	Margin	Detect or Type
	(MHz)	(dBuV)	(dB)	(dB)	(dB)	(dBuV/m)	(dBuV/m)	(dB)	
High Channel:5825MHz									
V	11650.00	50.84	30.55	5.77	24.66	50.72	74.00	-23.28	PK
V	11650.00	42.65	30.55	5.77	24.66	42.53	54.00	-11.47	AV
V	17475.00	49.53	30.33	6.32	24.55	50.07	68.20	-18.13	PK
V	17475.00	42.40	30.33	6.32	24.55	42.94	54.00	-11.06	AV
V	23300.00	50.60	30.85	7.45	24.69	51.89	68.20	-16.31	PK
V	23300.00	42.49	30.85	7.45	24.69	43.78	54.00	-10.22	AV
V	29125.00	53.18	31.02	8.99	25.57	56.72	68.20	-11.48	PK
V	29125.00	42.43	31.02	8.99	25.57	45.97	54.00	-8.03	AV
H	11650.00	51.83	30.55	5.77	24.66	51.71	74.00	-22.29	PK
H	11650.00	42.19	30.55	5.77	24.66	42.07	54.00	-11.93	AV
H	17475.00	52.42	30.33	6.32	24.55	52.96	68.20	-15.24	PK
H	17475.00	42.63	30.33	6.32	24.55	43.17	54.00	-10.83	AV
H	23300.00	53.26	30.85	7.45	24.69	54.55	68.20	-13.65	PK
H	23300.00	42.43	30.85	7.45	24.69	43.72	54.00	-10.28	AV
H	29125.00	49.25	31.02	8.99	25.57	52.79	68.20	-15.41	PK
H	29125.00	42.81	31.02	8.99	25.57	46.35	54.00	-7.65	AV

Remark:

1. Emission Level = Meter Reading + Antenna Factor + Cable Loss – Pre-amplifier, Margin= Emission Level - Limit
2. If peak below the average limit, the average emission was no test.
3. The amplitude of spurious emissions which are attenuated by more than 20dB below the permissible value has no need to be reported.



802.11n20

Polar (H/V)	Frequency	Meter Reading	Pre-amplifier	Cable Loss	Antenna Factor	Emission Level	Limits	Margin	Detect or Type
	(MHz)	(dBuV)	(dB)	(dB)	(dB)	(dBuV/m)	(dBuV/m)	(dB)	
Low Channel:5745MHz									
V	11490.00	50.58	30.55	5.77	24.66	50.46	74.00	-23.54	PK
V	11490.00	42.86	30.55	5.77	24.66	42.74	54.00	-11.26	AV
V	17235.00	51.85	30.33	6.32	24.55	52.39	68.20	-15.81	PK
V	17235.00	42.38	30.33	6.32	24.55	42.92	54.00	-11.08	AV
V	22980.00	49.46	30.85	7.45	24.69	50.75	74.00	-23.25	PK
V	22980.00	42.31	30.85	7.45	24.69	43.60	54.00	-10.40	AV
V	28725.00	52.71	31.02	8.99	25.57	56.25	68.20	-11.95	PK
V	28725.00	42.53	31.02	8.99	25.57	46.07	54.00	-7.93	AV
H	11490.00	51.33	30.55	5.77	24.66	51.21	74.00	-22.79	PK
H	11490.00	42.83	30.55	5.77	24.66	42.71	54.00	-11.29	AV
H	17235.00	53.34	30.33	6.32	24.55	53.88	68.20	-14.32	PK
H	17235.00	42.54	30.33	6.32	24.55	43.08	54.00	-10.92	AV
H	22980.00	51.30	30.85	7.45	24.69	52.59	74.00	-21.41	PK
H	22980.00	42.77	30.85	7.45	24.69	44.06	54.00	-9.94	AV
H	28725.00	51.89	31.02	8.99	25.57	55.43	68.20	-12.77	PK
H	28725.00	43.00	31.02	8.99	25.57	46.54	54.00	-7.46	AV

Polar (H/V)	Frequency	Meter Reading	Pre-amplifier	Cable Loss	Antenna Factor	Emission Level	Limits	Margin	Detect or Type
	(MHz)	(dBuV)	(dB)	(dB)	(dB)	(dBuV/m)	(dBuV/m)	(dB)	
Middle Channel:5785MHz									
V	11570.00	50.59	30.55	5.77	24.66	50.47	74.00	-23.53	PK
V	11570.00	42.98	30.55	5.77	24.66	42.86	54.00	-11.14	AV
V	17355.00	49.73	30.33	6.32	24.55	50.27	68.20	-17.93	PK
V	17355.00	42.78	30.33	6.32	24.55	43.32	54.00	-10.68	AV
V	23140.00	51.81	30.85	7.45	24.69	53.10	68.20	-15.10	PK
V	23140.00	42.59	30.85	7.45	24.69	43.88	54.00	-10.12	AV
V	28925.00	49.76	31.02	8.99	25.57	53.30	68.20	-14.90	PK
V	28925.00	42.81	31.02	8.99	25.57	46.35	54.00	-7.65	AV
H	11570.00	49.94	30.55	5.77	24.66	49.82	74.00	-24.18	PK
H	11570.00	43.06	30.55	5.77	24.66	42.94	54.00	-11.06	AV
H	17355.00	54.17	30.33	6.32	24.55	54.71	68.20	-13.49	PK
H	17355.00	42.59	30.33	6.32	24.55	43.13	54.00	-10.87	AV
H	23140.00	51.68	30.85	7.45	24.69	52.97	68.20	-15.23	PK
H	23140.00	43.00	30.85	7.45	24.69	44.29	54.00	-9.71	AV
H	28925.00	49.58	31.02	8.99	25.57	53.12	68.20	-15.08	PK
H	28925.00	43.18	31.02	8.99	25.57	46.72	54.00	-7.28	AV



Polar (H/V)	Frequency	Meter Reading	Pre-ampli fier	Cable Loss	Antenna Factor	Emission Level	Limits	Margin	Detect or Type
	(MHz)	(dBuV)	(dB)	(dB)	(dB)	(dBuV/m)	(dBuV/m)	(dB)	
High Channel:5825MHz									
V	11650.00	51.09	30.55	5.77	24.66	50.97	74.00	-23.03	PK
V	11650.00	42.90	30.55	5.77	24.66	42.78	54.00	-11.22	AV
V	17475.00	49.78	30.33	6.32	24.55	50.32	68.20	-17.88	PK
V	17475.00	42.65	30.33	6.32	24.55	43.19	54.00	-10.81	AV
V	23300.00	50.85	30.85	7.45	24.69	52.14	68.20	-16.06	PK
V	23300.00	42.74	30.85	7.45	24.69	44.03	54.00	-9.97	AV
V	29125.00	53.43	31.02	8.99	25.57	56.97	68.20	-11.23	PK
V	29125.00	42.68	31.02	8.99	25.57	46.22	54.00	-7.78	AV
H	11650.00	52.08	30.55	5.77	24.66	51.96	74.00	-22.04	PK
H	11650.00	42.44	30.55	5.77	24.66	42.32	54.00	-11.68	AV
H	17475.00	52.67	30.33	6.32	24.55	53.21	68.20	-14.99	PK
H	17475.00	42.88	30.33	6.32	24.55	43.42	54.00	-10.58	AV
H	23300.00	53.51	30.85	7.45	24.69	54.80	68.20	-13.40	PK
H	23300.00	42.68	30.85	7.45	24.69	43.97	54.00	-10.03	AV
H	29125.00	49.50	31.02	8.99	25.57	53.04	68.20	-15.16	PK
H	29125.00	43.06	31.02	8.99	25.57	46.60	54.00	-7.40	AV

Remark:

1. Emission Level = Meter Reading + Antenna Factor + Cable Loss – Pre-amplifier,
Margin= Emission Level - Limit

2. If peak below the average limit, the average emission was no test.

3. The amplitude of spurious emissions which are attenuated by more than 20dB below the permissible value has no need to be reported.



802.11ac20

Polar (H/V)	Frequency	Meter Reading	Pre-amplifier	Cable Loss	Antenna Factor	Emission Level	Limits	Margin	Detect or Type
	(MHz)	(dBuV)	(dB)	(dB)	(dB)	(dBuV/m)	(dBuV/m)	(dB)	
Low Channel:5745MHz									
V	11490.00	50.66	30.55	5.77	24.66	50.54	74.00	-23.46	PK
V	11490.00	42.94	30.55	5.77	24.66	42.82	54.00	-11.18	AV
V	17235.00	51.93	30.33	6.32	24.55	52.47	68.20	-15.73	PK
V	17235.00	42.46	30.33	6.32	24.55	43.00	54.00	-11.00	AV
V	22980.00	49.54	30.85	7.45	24.69	50.83	74.00	-23.17	PK
V	22980.00	42.39	30.85	7.45	24.69	43.68	54.00	-10.32	AV
V	28725.00	52.79	31.02	8.99	25.57	56.33	68.20	-11.87	PK
V	28725.00	42.61	31.02	8.99	25.57	46.15	54.00	-7.85	AV
H	11490.00	51.41	30.55	5.77	24.66	51.29	74.00	-22.71	PK
H	11490.00	42.91	30.55	5.77	24.66	42.79	54.00	-11.21	AV
H	17235.00	53.42	30.33	6.32	24.55	53.96	68.20	-14.24	PK
H	17235.00	42.62	30.33	6.32	24.55	43.16	54.00	-10.84	AV
H	22980.00	51.38	30.85	7.45	24.69	52.67	74.00	-21.33	PK
H	22980.00	42.85	30.85	7.45	24.69	44.14	54.00	-9.86	AV
H	28725.00	51.97	31.02	8.99	25.57	55.51	68.20	-12.69	PK
H	28725.00	43.08	31.02	8.99	25.57	46.62	54.00	-7.38	AV

Polar (H/V)	Frequency	Meter Reading	Pre-amplifier	Cable Loss	Antenna Factor	Emission Level	Limits	Margin	Detect or Type
	(MHz)	(dBuV)	(dB)	(dB)	(dB)	(dBuV/m)	(dBuV/m)	(dB)	
Middle Channel:5785MHz									
V	11570.00	50.71	30.55	5.77	24.66	50.59	74.00	-23.41	PK
V	11570.00	43.10	30.55	5.77	24.66	42.98	54.00	-11.02	AV
V	17355.00	49.85	30.33	6.32	24.55	50.39	68.20	-17.81	PK
V	17355.00	42.90	30.33	6.32	24.55	43.44	54.00	-10.56	AV
V	23140.00	51.93	30.85	7.45	24.69	53.22	68.20	-14.98	PK
V	23140.00	42.71	30.85	7.45	24.69	44.00	54.00	-10.00	AV
V	28925.00	49.88	31.02	8.99	25.57	53.42	68.20	-14.78	PK
V	28925.00	42.93	31.02	8.99	25.57	46.47	54.00	-7.53	AV
H	11570.00	50.06	30.55	5.77	24.66	49.94	74.00	-24.06	PK
H	11570.00	43.18	30.55	5.77	24.66	43.06	54.00	-10.94	AV
H	17355.00	54.29	30.33	6.32	24.55	54.83	68.20	-13.37	PK
H	17355.00	42.71	30.33	6.32	24.55	43.25	54.00	-10.75	AV
H	23140.00	51.80	30.85	7.45	24.69	53.09	68.20	-15.11	PK
H	23140.00	43.12	30.85	7.45	24.69	44.41	54.00	-9.59	AV
H	28925.00	49.70	31.02	8.99	25.57	53.24	68.20	-14.96	PK
H	28925.00	43.30	31.02	8.99	25.57	46.84	54.00	-7.16	AV



Polar (H/V)	Frequency	Meter Reading	Pre-ampli fier	Cable Loss	Antenna Factor	Emission Level	Limits	Margin	Detect or Type
	(MHz)	(dBuV)	(dB)	(dB)	(dB)	(dBuV/m)	(dBuV/m)	(dB)	
High Channel:5825MHz									
V	11650.00	51.01	30.55	5.77	24.66	50.89	74.00	-23.11	PK
V	11650.00	42.82	30.55	5.77	24.66	42.70	54.00	-11.30	AV
V	17475.00	49.70	30.33	6.32	24.55	50.24	68.20	-17.96	PK
V	17475.00	42.57	30.33	6.32	24.55	43.11	54.00	-10.89	AV
V	23300.00	50.77	30.85	7.45	24.69	52.06	68.20	-16.14	PK
V	23300.00	42.66	30.85	7.45	24.69	43.95	54.00	-10.05	AV
V	29125.00	53.35	31.02	8.99	25.57	56.89	68.20	-11.31	PK
V	29125.00	42.60	31.02	8.99	25.57	46.14	54.00	-7.86	AV
H	11650.00	52.00	30.55	5.77	24.66	51.88	74.00	-22.12	PK
H	11650.00	42.36	30.55	5.77	24.66	42.24	54.00	-11.76	AV
H	17475.00	52.59	30.33	6.32	24.55	53.13	68.20	-15.07	PK
H	17475.00	42.80	30.33	6.32	24.55	43.34	54.00	-10.66	AV
H	23300.00	53.43	30.85	7.45	24.69	54.72	68.20	-13.48	PK
H	23300.00	42.60	30.85	7.45	24.69	43.89	54.00	-10.11	AV
H	29125.00	49.42	31.02	8.99	25.57	52.96	68.20	-15.24	PK
H	29125.00	42.98	31.02	8.99	25.57	46.52	54.00	-7.48	AV

Remark:

1. Emission Level = Meter Reading + Antenna Factor + Cable Loss – Pre-amplifier, Margin= Emission Level - Limit
2. If peak below the average limit, the average emission was no test.
3. The amplitude of spurious emissions which are attenuated by more than 20dB below the permissible value has no need to be reported.



5. POWER SPECTRAL DENSITY TEST

5.1 APPLIED PROCEDURES / LIMIT

According to FCC §15.407(3)

Power limits:

(1) For the band 5.15-5.25 GHz.

(i) For an outdoor access point operating in the band 5.15-5.25 GHz, the maximum power spectral density shall not exceed 17 dBm in any 1 megahertz band. If transmitting antennas of directional gain greater than 6 dBi are used, both the maximum conducted output power and the maximum power spectral density shall be reduced by the amount in dB that the directional gain of the antenna exceeds 6 dBi. The maximum e.i.r.p. at any elevation angle above 30 degrees as measured from the horizon must not exceed 125 mW (21 dBm).

(ii) For an indoor access point operating in the band 5.15-5.25 GHz, the maximum power spectral density shall not exceed 17 dBm in any 1 megahertz band. If transmitting antennas of directional gain greater than 6 dBi are used, both the maximum conducted output power and the maximum power spectral density shall be reduced by the amount in dB that the directional gain of the antenna exceeds 6 dBi.

(iii) For fixed point-to-point access points operating in the band 5.15-5.25 GHz, the maximum power spectral density shall not exceed 17 dBm in any 1 megahertz band. Fixed point-to-point U-NII devices may employ antennas with directional gain up to 23 dBi without any corresponding reduction in the maximum conducted output power or maximum power spectral density. For fixed point-to-point transmitters that employ a directional antenna gain greater than 23 dBi, a 1 dB reduction in maximum conducted output power and maximum power spectral density is required for each 1 dB of antenna gain in excess of 23 dBi. Fixed, point-to-point operations exclude the use of point-to-multipoint systems, omnidirectional applications, and multiple collocated transmitters transmitting the same information. The operator of the U-NII device, or if the equipment is professionally installed, the installer, is responsible for ensuring that systems employing high gain directional antennas are used exclusively for fixed, point-to-point operations.

(iv) For client devices in the 5.15-5.25 GHz band, the maximum power spectral density shall not exceed 11 dBm in any 1 megahertz band. If transmitting antennas of directional gain greater than 6 dBi are used, both the maximum conducted output power and the maximum power spectral density shall be reduced by the amount in dB that the directional gain of the antenna exceeds 6 dBi.

(2) For the 5.25-5.35 GHz and 5.47-5.725 GHz bands, the maximum conducted output power over the frequency bands of operation shall not exceed the lesser of 250 mW or $11 \text{ dBm} + 10 \log B$, where B is the 26 dB emission bandwidth in megahertz. In addition, the maximum power spectral density shall not exceed 11 dBm in any 1 megahertz band. If transmitting antennas of directional gain greater than 6 dBi are used, both the maximum conducted output power and the maximum power spectral density shall be reduced by the amount in dB that the directional gain of the antenna exceeds 6 dBi.

(3) For the band 5.725-5.85 GHz, the maximum conducted output power over the frequency band of operation shall not exceed 1 W. In addition, the maximum power spectral density shall not exceed 30 dBm in any 500-kHz band. If transmitting antennas of directional gain greater than 6 dBi are used, both the maximum conducted output power and the maximum power spectral density shall be reduced by the amount in dB that the directional gain of the antenna exceeds 6 dBi. However, fixed point-to-point U-NII devices operating in this band may employ transmitting antennas with directional gain greater than 6 dBi without any corresponding reduction in transmitter conducted power. Fixed, point-to-point operations exclude the use of point-to-multipoint systems, omnidirectional applications, and multiple collocated transmitters transmitting the same information. The operator of the U-NII device, or if the equipment is professionally installed, the installer, is responsible for ensuring that systems employing high gain directional antennas are used exclusively for fixed, point-to-point operations.



5.2 TEST PROCEDURE

For devices operating in the bands 5.15-5.25 GHz, 5.25-5.35 GHz, and 5.47-5.725 GHz, the above procedures make use of 1 MHz RBW to satisfy directly the 1 MHz reference bandwidth specified in § 15.407(a)(5). For devices operating in the band 5.725-5.85 GHz, the rules specify a measurement bandwidth of 500 kHz. Many spectrum analyzers do not have 500 kHz RBW, thus a narrower RBW may need to be used. The rules permit the use of a RBWs less than 1 MHz, or 500 kHz, “provided that the measured power is integrated over the full reference bandwidth” to show the total power over the specified measurement bandwidth (i.e., 1 MHz, or 500 kHz). If measurements are performed using a reduced resolution bandwidth (< 1 MHz, or < 500 kHz) and integrated over 1 MHz, or 500 KHz bandwidth, the following adjustments to the procedures apply:

- a) Set $RBW \geq 1/T$, where T is defined in section II.B.I.a).
- b) Set $VBW \geq 3 RBW$.
- c) If measurement bandwidth of Maximum PSD is specified in 500 kHz, add $10\log(500\text{kHz}/RBW)$ to the measured result, whereas RBW (< 500 KHz) is the reduced resolution bandwidth of the spectrum analyzer set during measurement.
- d) If measurement bandwidth of Maximum PSD is specified in 1 MHz, add $10\log(1\text{MHz}/RBW)$ to the measured result, whereas RBW (< 1 MHz) is the reduced resolution bandwidth of spectrum analyzer set during measurement.
- e) Care must be taken to ensure that the measurements are performed during a period of continuous transmission or are corrected upward for duty cycle.

Note: As a practical matter, it is recommended to use reduced RBW of 100 KHz for the sections 5.c) and 5.d) above, since RBW=100 KHZ is available on nearly all spectrum analyzers.

5.3 DEVIATION FROM STANDARD

No deviation.

5.4 TEST SETUP



5.5 EUT OPERATION CONDITIONS

The EUT tested system was configured as the statements of 2.1 Unless otherwise a special operating condition is specified in the follows during the testing.



5.6 TEST RESULTS

Temperature :	26 °C	Relative Humidity :	54%
Pressure :	1015 hPa	Test Voltage :	DC 24V
Test Band :	5.2G		

5.2G						
Test mode	Test Channel (MHz)	PSD (dBm)	duty cycle Factor (dB)	Total PSD (dBm)	Limit (dBm/MHz)	Result
802.11a	5180	-1.193	2.41	1.217	11	Pass
	5200	-1.083	2.41	1.327	11	Pass
	5240	-0.715	2.41	1.695	11	Pass
802.11n20	5180	-1.673	2.58	0.907	11	Pass
	5200	-1.256	2.58	1.324	11	Pass
	5240	-1.622	2.58	0.958	11	Pass
802.11n40	5190	-5.343	2.55	-2.793	11	Pass
	5230	-5.138	2.55	-2.588	11	Pass
802.11ac20	5180	-1.995	2.55	0.555	11	Pass
	5200	-2.698	2.55	-0.148	11	Pass
	5240	-2.198	2.55	0.352	11	Pass
802.11ac40	5190	-6.852	4.17	-2.682	11	Pass
	5230	-6.313	4.17	-2.143	11	Pass
802.11ac80	5210	-10.122	6.26	-3.862	11	Pass

Note: duty cycle Factor see page 86.



(802.11a) PSD plot on channel 36

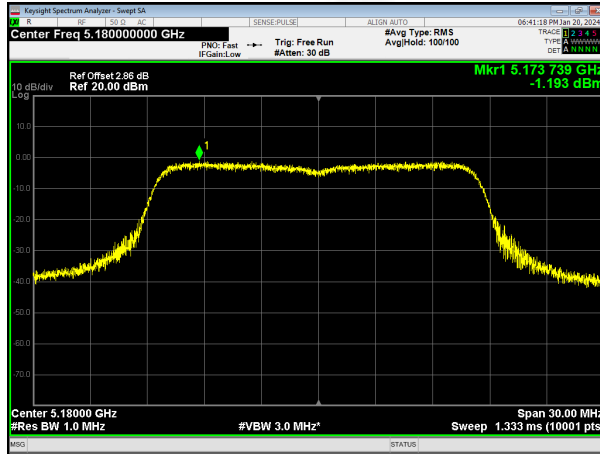

(802.11a) PSD plot on channel 40

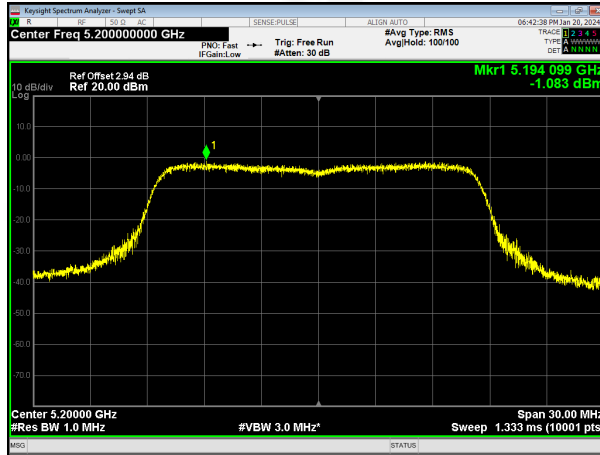

(802.11a) PSD plot on channel 48

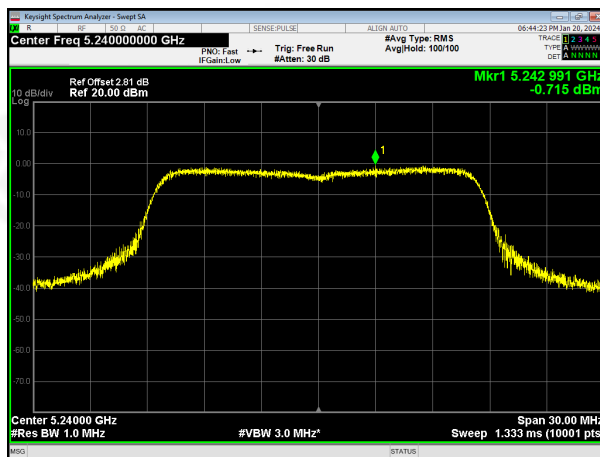



(802.11n20) PSD plot on channel 36

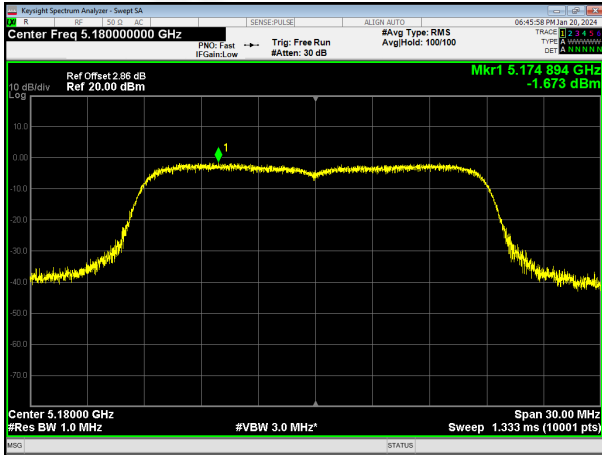

(802.11n40) PSD plot on channel 38

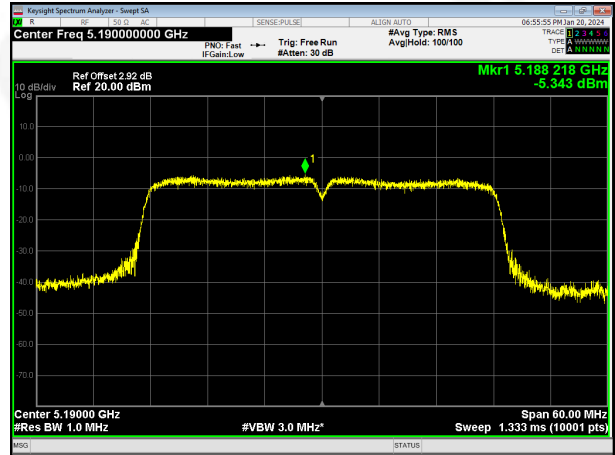

(802.11n20) PSD plot on channel 40

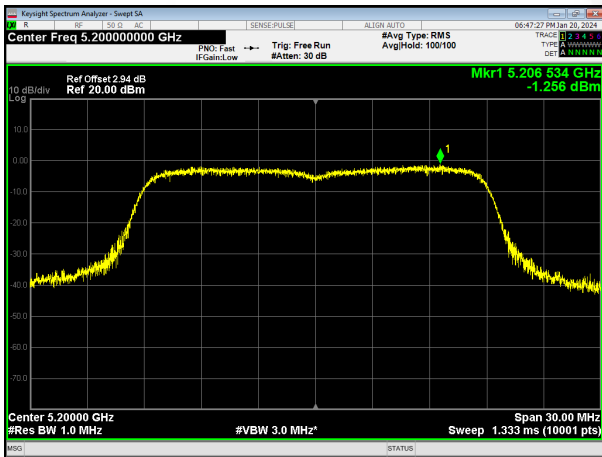

(802.11n40) PSD plot on channel 46

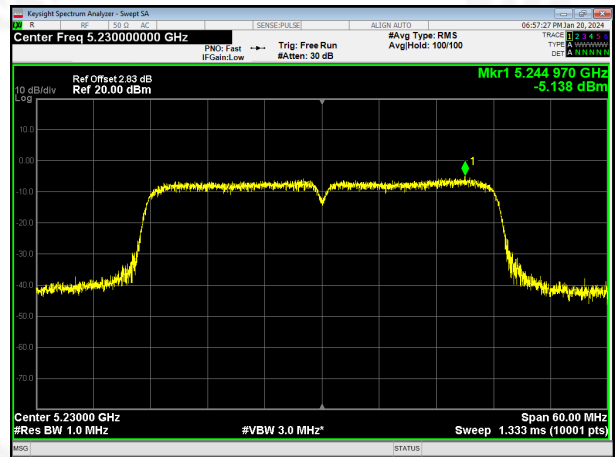

(802.11n20) PSD plot on channel 48

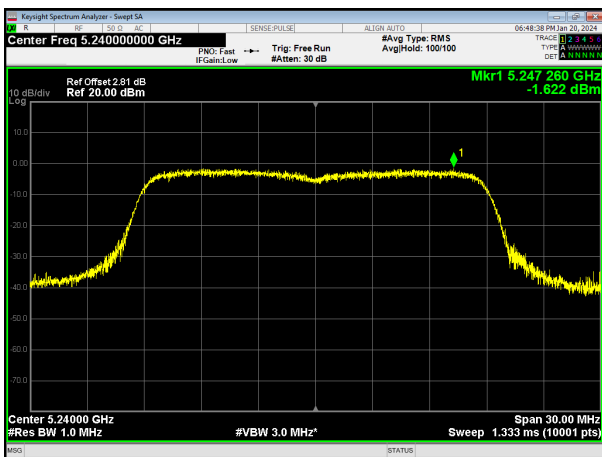



(802.11ac20) PSD plot on channel 36

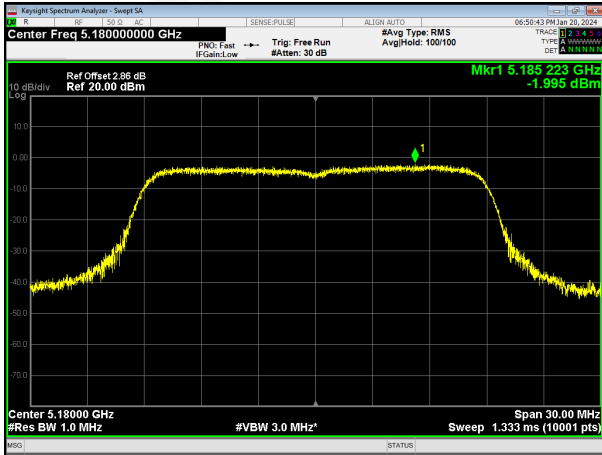

(802.11ac40) PSD plot on channel 38

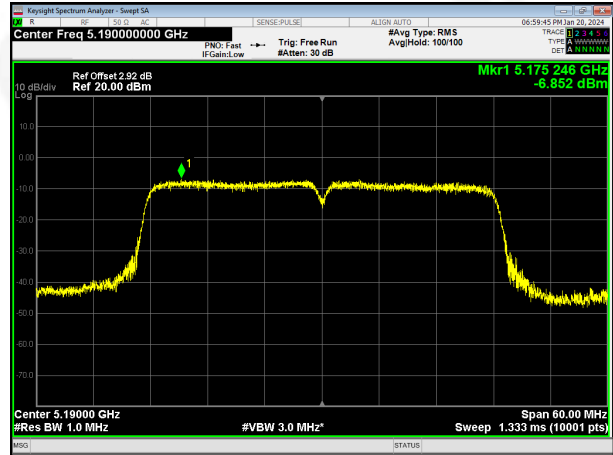

(802.11ac20) PSD plot on channel 40

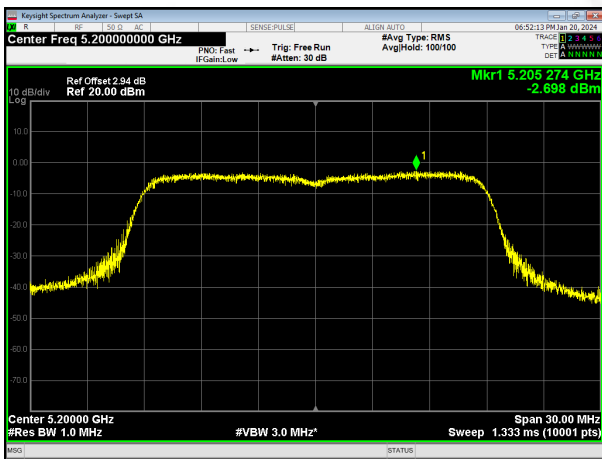

(802.11ac40) PSD plot on channel 46

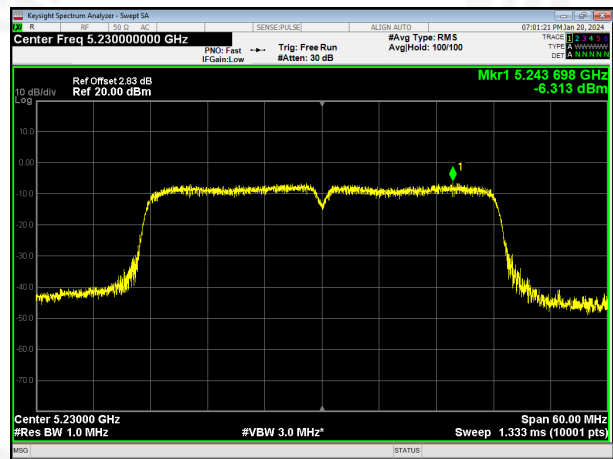

(802.11ac20) PSD plot on channel 48

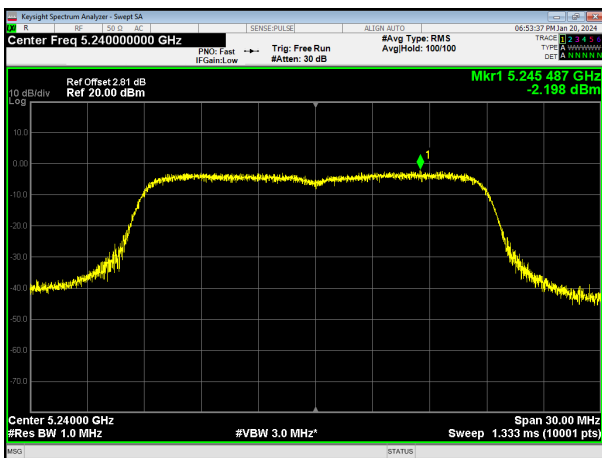

(802.11ac80) PSD plot on channel 42

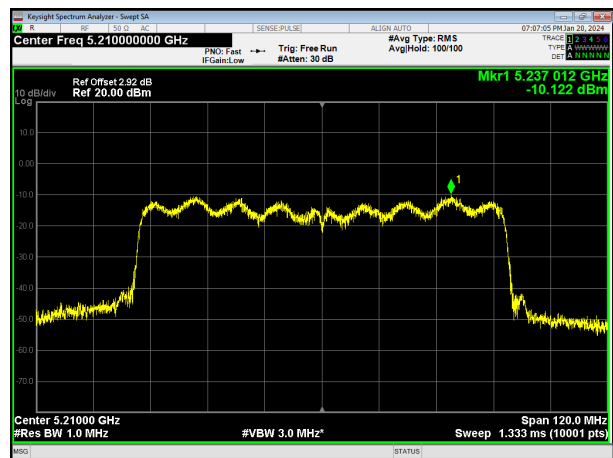



Temperature :	26 °C	Relative Humidity :	54%
Pressure :	1015 hPa	Test Voltage :	DC 24V
Test Band :	5.8G		

5.8G						
Test mode	Test Channel (MHz)	PSD (dBm/500kHz)	duty cycle Factor (dB)	Total PSD (dBm)	Limit (dBm/500kHz)	Result
802.11a	5745	-3.58	2.48	-1.100	30	Pass
	5785	-3.049	2.48	-0.569	30	Pass
	5825	-3.303	2.48	-0.823	30	Pass
802.11n20	5745	-2.958	2.55	-0.408	30	Pass
	5785	-3.469	2.55	-0.919	30	Pass
	5825	-3.213	2.55	-0.663	30	Pass
802.11n40	5755	-8.724	4.14	-4.584	30	Pass
	5795	-7.852	4.14	-3.712	30	Pass
802.11ac20	5745	-4.719	2.60	-2.119	30	Pass
	5785	-4.306	2.60	-1.706	30	Pass
	5825	-4.343	2.60	-1.743	30	Pass
802.11ac40	5755	-8.283	4.14	-4.143	30	Pass
	5795	-8.256	4.14	-4.116	30	Pass
802.11ac80	5775	-12.37	6.27	-6.100	30	Pass
Note: duty cycle Factor see page 90.						



(802.11a) PSD plot on channel 149

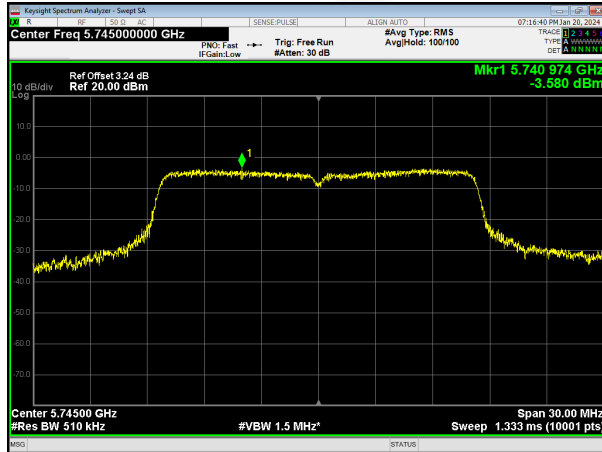

(802.11a) PSD plot on channel 157

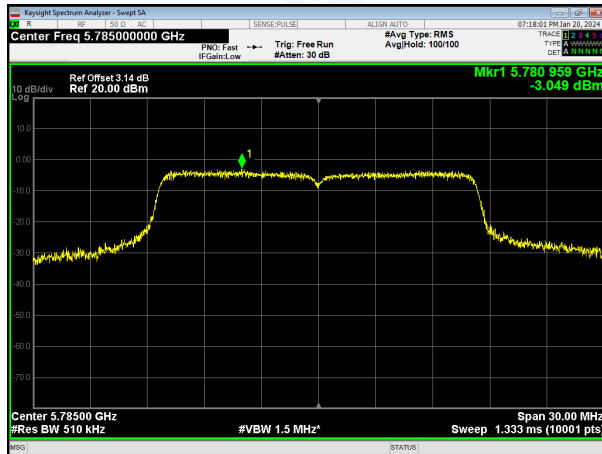

(802.11a) PSD plot on channel 165





(802.11n20) PSD plot on channel 149

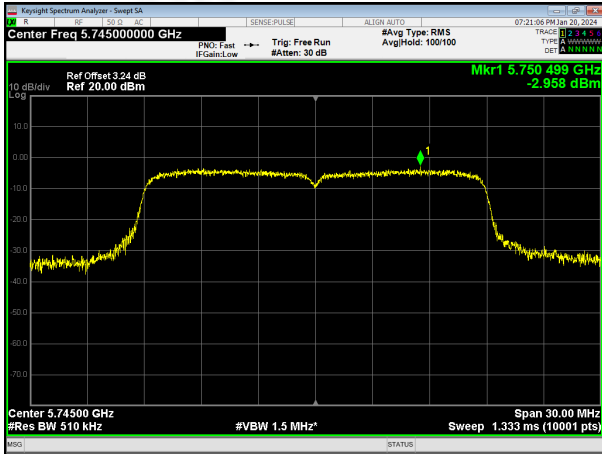

(802.11n40) PSD plot on channel 151

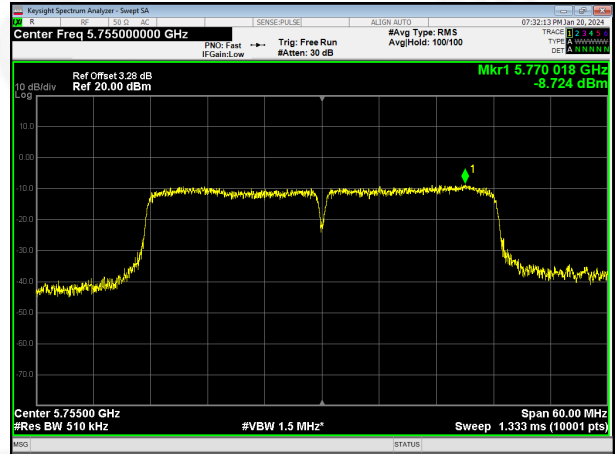

(802.11n20) PSD plot on channel 157

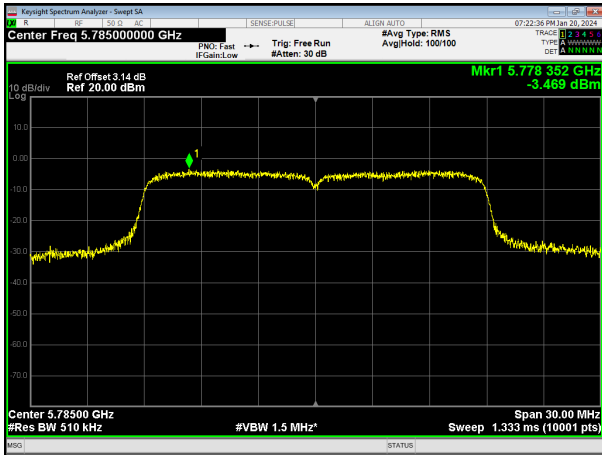

(802.11n40) PSD plot on channel 159

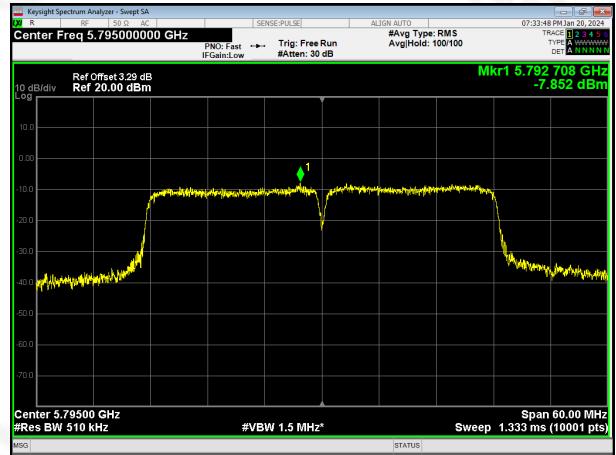

(802.11n20) PSD plot on channel 165

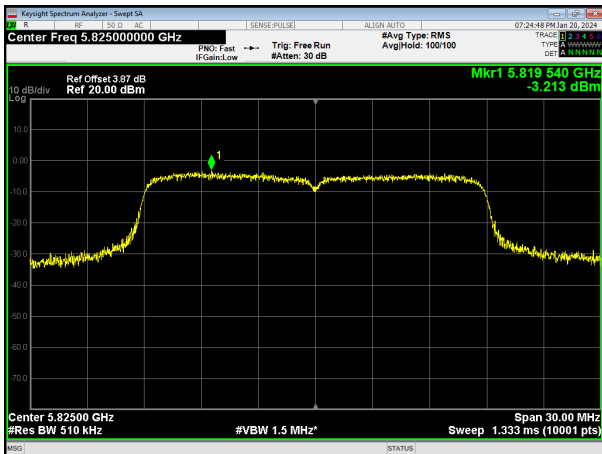



(802.11ac20) PSD plot on channel 149

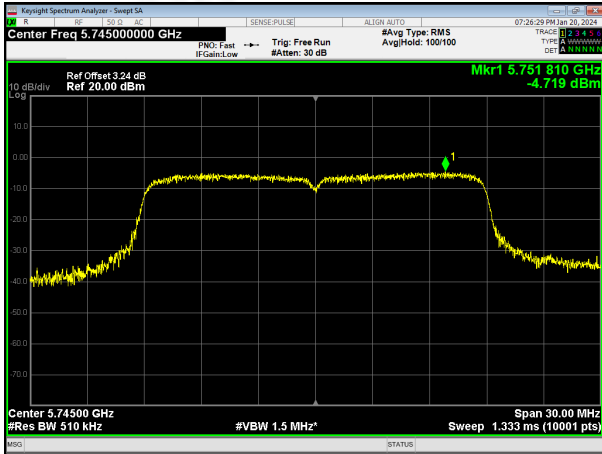

(802.11ac40) PSD plot on channel 151

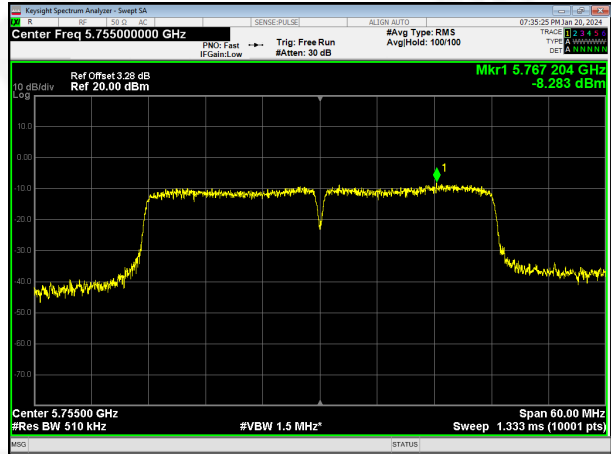

(802.11ac20) PSD plot on channel 157

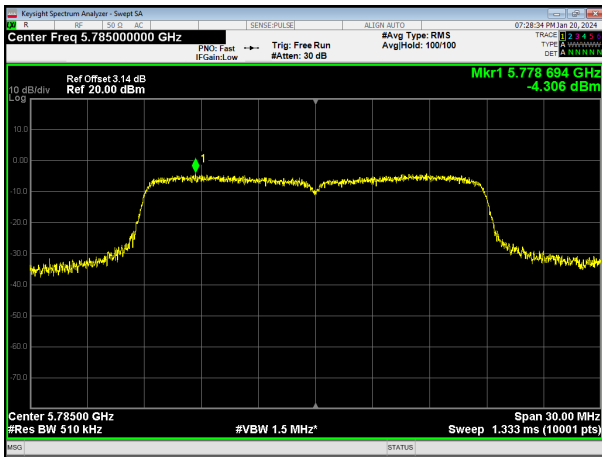

(802.11ac40) PSD plot on channel 159

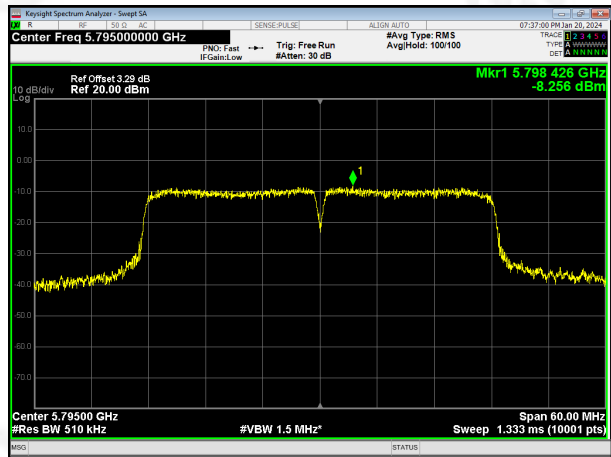

(802.11ac20) PSD plot on channel 165

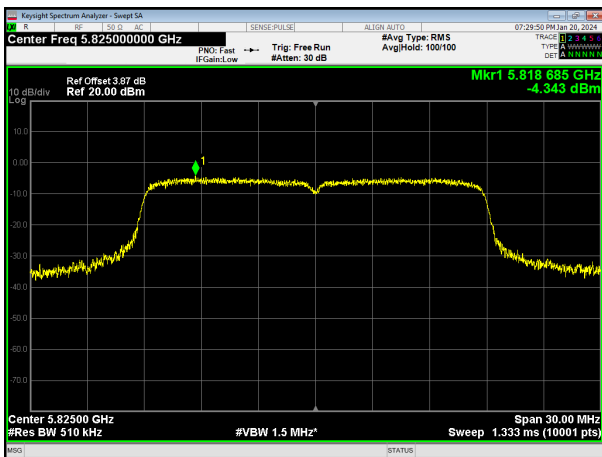

(802.11ac80) PSD plot on channel 155

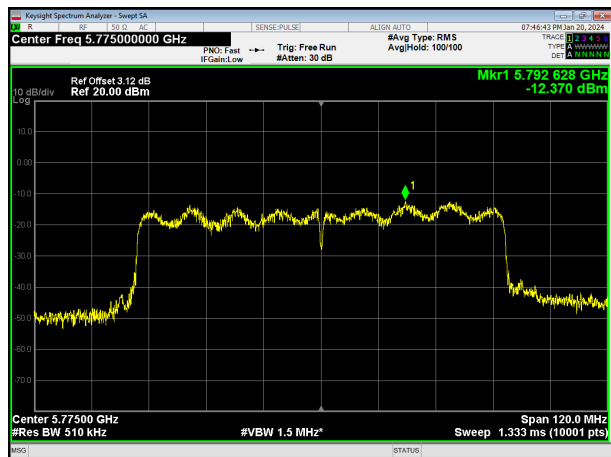



6. 26DB EMISSION BANDWIDTH & 6DB OCCUPIED BANDWIDTH

6.1 APPLIED PROCEDURES / LIMIT

The maximum power spectral density is measured as a conducted emission by direct connection of a calibrated test instrument to the equipment under test. If the device cannot be connected directly, alternative techniques acceptable to the Commission may be used. Measurements in the 5.725-5.85 GHz band, the minimum bandwidth 6 dB bandwidth of U-NII devices shall be at least 500KHz. Measurements in the 5.15-5.25 GHz, 5.25-5.35 GHz, and the 5.47-5.725 GHz bands are made over a bandwidth of 1 MHz or the 26 dB emission bandwidth of the device, whichever is less. A narrower resolution bandwidth can be used, provided that the measured power is integrated over the full reference bandwidth.

6.2 TEST PROCEDURE

The following procedure shall be used for measuring 6dB Occupied Bandwidth:

The procedure for this method is as follows:

- a) Set RBW = 100KHz.
- b) Set the VBW > RBW.
- c) Detector = Peak.
- d) Trace mode = max hold.
- e) Measure the maximum width of the emission that is constrained by the frequencies associated with the two outermost amplitude points (upper and lower frequencies) that are attenuated by 6 dB relative to the maximum level measured in the fundamental emission.

The following procedure shall be used for measuring 26dB Emission bandwidth:

The procedure for this method is as follows:

- a) Set RBW = approximately 1% of the emission bandwidth.
- b) Set the VBW > RBW.
- c) Detector = peak.
- d) Trace mode = max hold.
- e) Measure the maximum width of the emission that is 26 dB down from the peak of the emission. Compare this with the RBW setting of the instrument. Readjust RBW and repeat measurement as needed until the RBW/EBW ratio is approximately 1%.



6.3 EUT OPERATION CONDITIONS

The EUT tested system was configured as the statements of 2.4 Unless otherwise a special operating condition is specified in the follows during the testing.



6.4 TEST RESULTS

Temperature :	26 °C	Relative Humidity :	54%
Pressure :	101kPa	Test Voltage :	DC 24V
Test Band :	5.2G		

5.2G				
Test Mode	Test Channel (MHz)	26dB Emission Bandwidth (MHz)	Limit(KHz)	Result
802.11a	5180	20.68	N/A	Pass
	5200	20.00		
	5240	21.01		
802.11n20	5180	20.65	N/A	Pass
	5200	20.67		
	5240	20.72		
802.11n40	5190	42.78	N/A	Pass
	5230	42.43		
802.11ac20	5180	20.64	N/A	Pass
	5200	20.75		
	5240	20.93		
802.11ac40	5190	40.99	N/A	Pass
	5230	41.24		
802.11ac80	5210	80.65	N/A	Pass



5.2G Test plot

(802.11 a) 26dB Bandwidth plot on channel 36

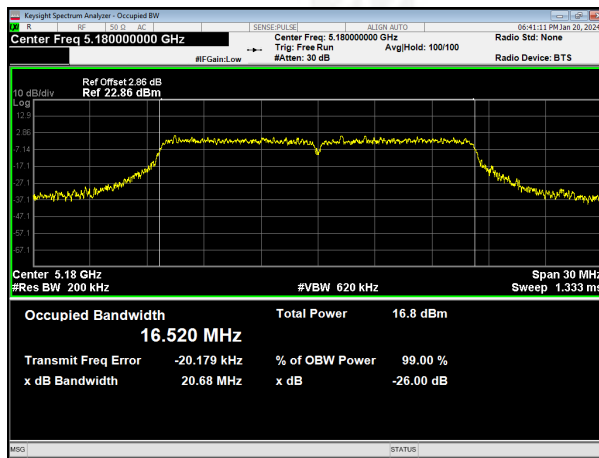

(802.11 a) 26dB Bandwidth plot on channel 48

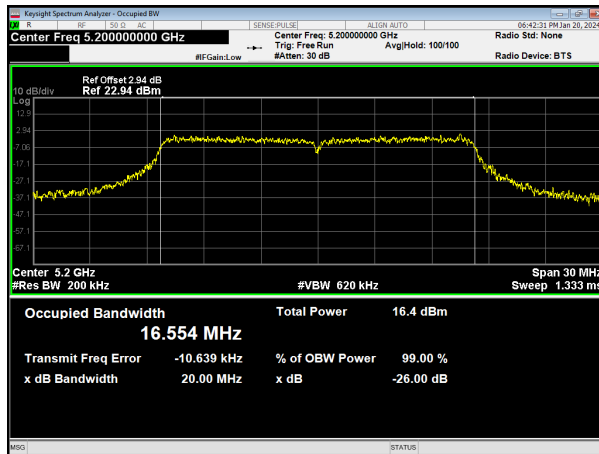

(802.11 a) 26dB Bandwidth plot on channel 48

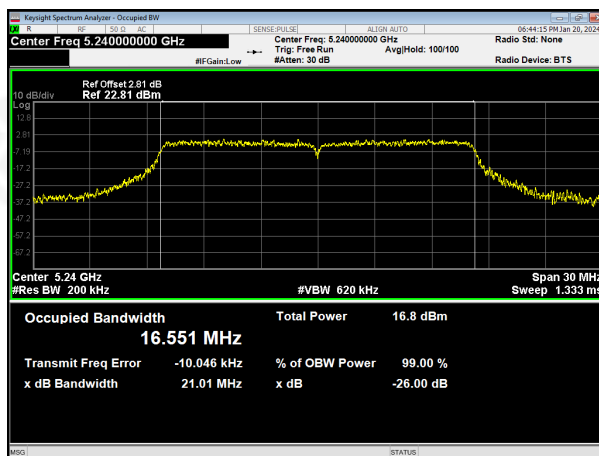



5.2G Test plot

(802.11 n20) 26dB Bandwidth plot on channel 36

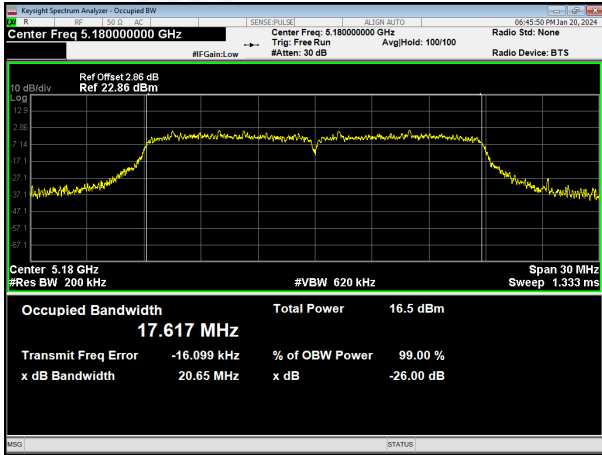

(802.11 n40) 26dB Bandwidth plot on channel 38

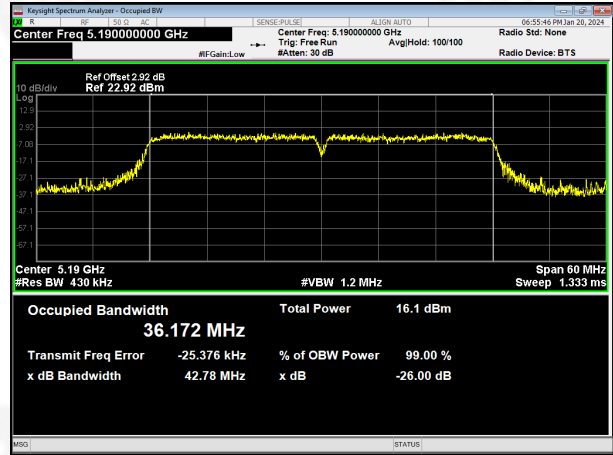

(802.11 n20) 26dB Bandwidth plot on channel 40

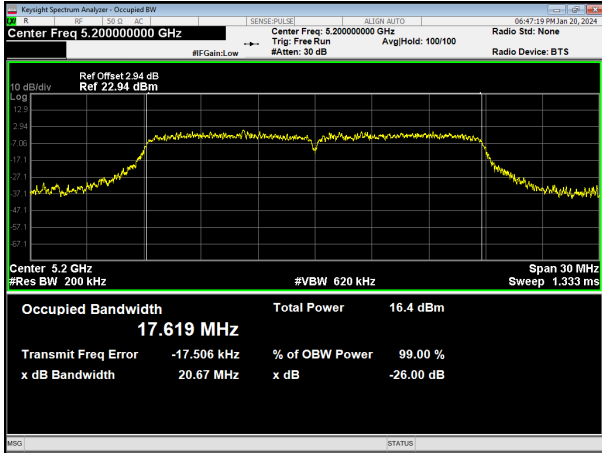

(802.11 n40) 26dB Bandwidth plot on channel 46

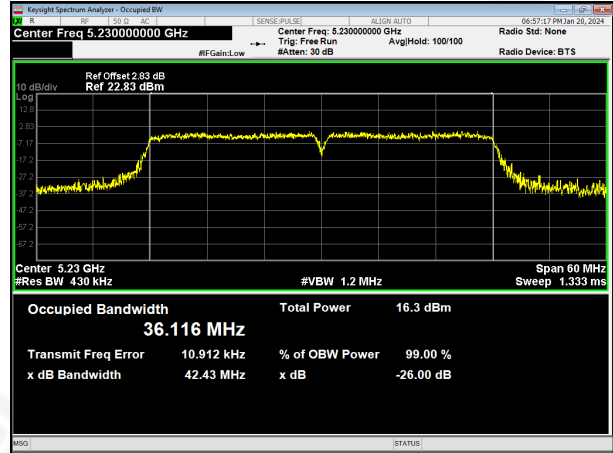

(802.11 n20) 26dB Bandwidth plot on channel 48

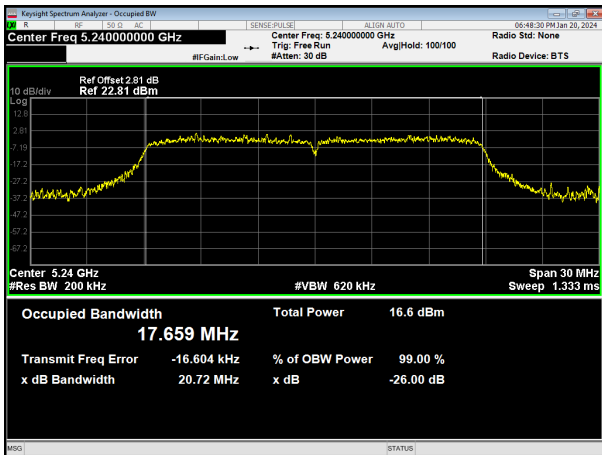



5.2G Test plot

(802.11 ac20) 26dB Bandwidth plot on channel 36

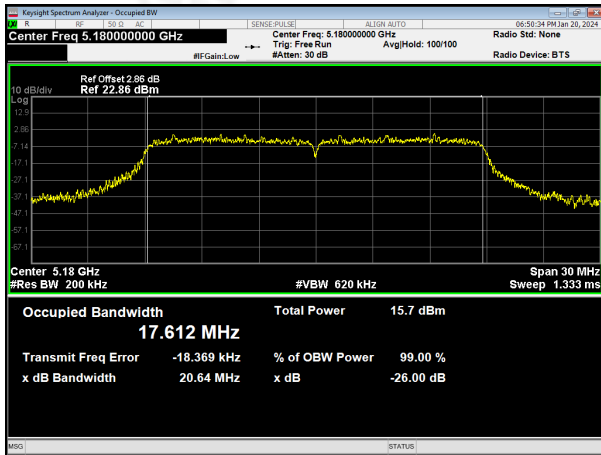

(802.11 ac40) 26dB Bandwidth plot on channel 38

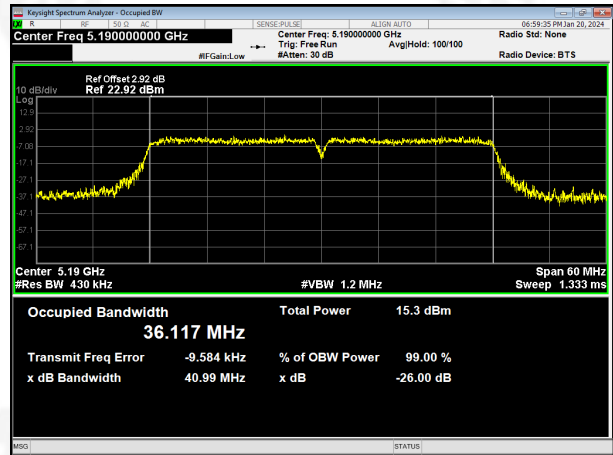

(802.11 ac20) 26dB Bandwidth plot on channel 40

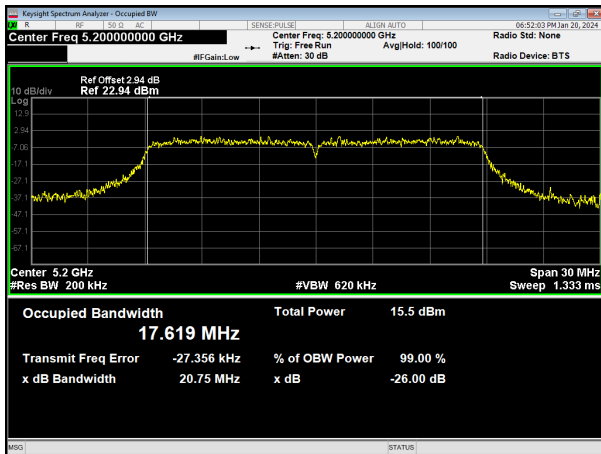

(802.11 ac40) 26dB Bandwidth plot on channel 46

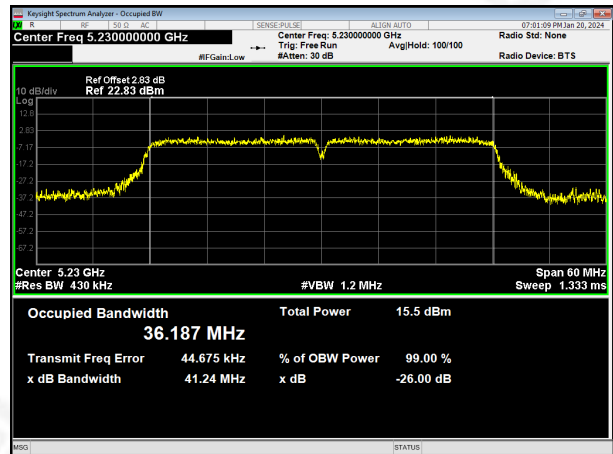

(802.11 ac20) 26dB Bandwidth plot on channel 48

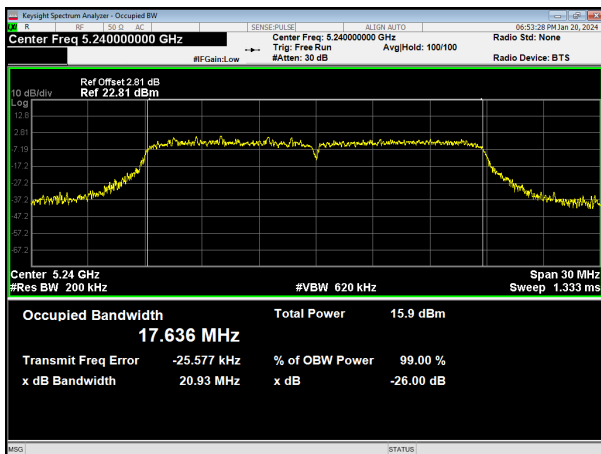

(802.11 ac80) 26dB Bandwidth plot on channel 42

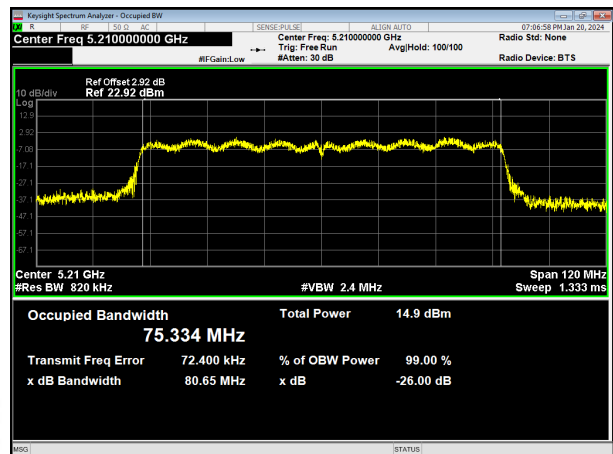



Temperature :	26 °C	Relative Humidity :	54%
Pressure :	101kPa	Test Voltage :	DC 24V
Test Band :	5.8G		

5.8G				
Test Mode	Test Channel (MHz)	6dB Occupied Bandwidth (MHz)	Limit(KHz)	Result
802.11a	5745	16.31	>500	Pass
	5785	16.06		
	5825	16.35		
802.11n20	5745	17.05	>500	Pass
	5785	17.01		
	5825	17.12		
802.11n40	5755	35.03	>500	Pass
	5795	35.01		
802.11ac20	5745	17.00	>500	Pass
	5785	17.33		
	5825	17.22		
802.11ac40	5755	34.69	>500	Pass
	5795	35.09		
802.11ac80	5775	73.80	>500	Pass



5.8G Test plot

(802.11a) 6dB Bandwidth plot on channel 149

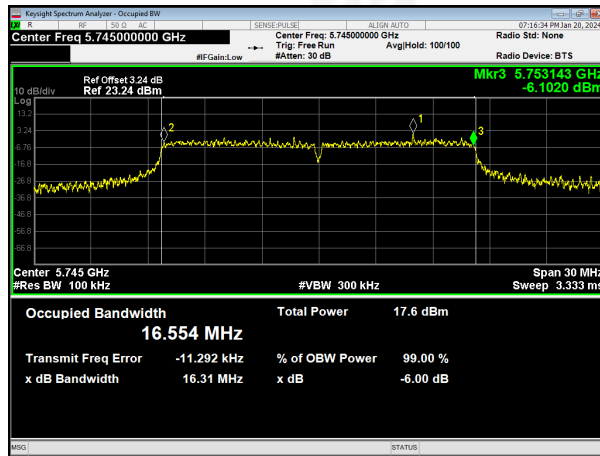

(802.11a) 6dB Bandwidth plot on channel 157

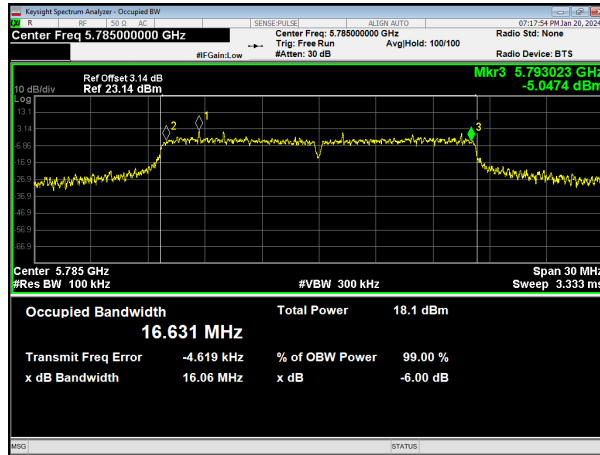

(802.11a) 6dB Bandwidth plot on channel 165

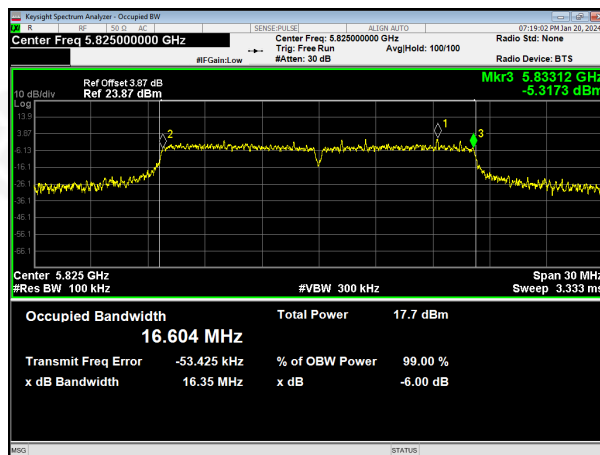



5.8G Test plot

(802.11n20) 6dB Bandwidth plot on channel 149

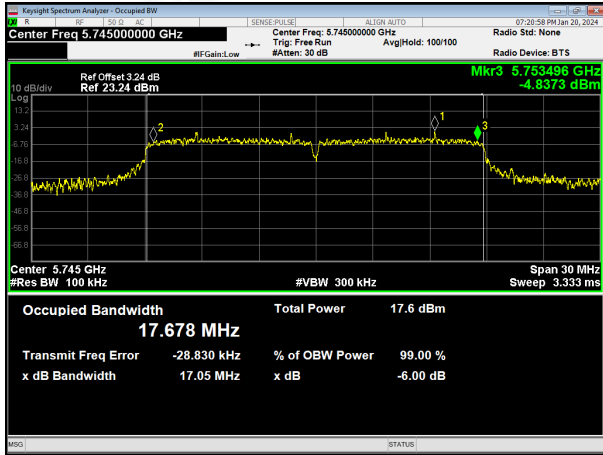

(802.11n40) 6dB Bandwidth plot on channel 151

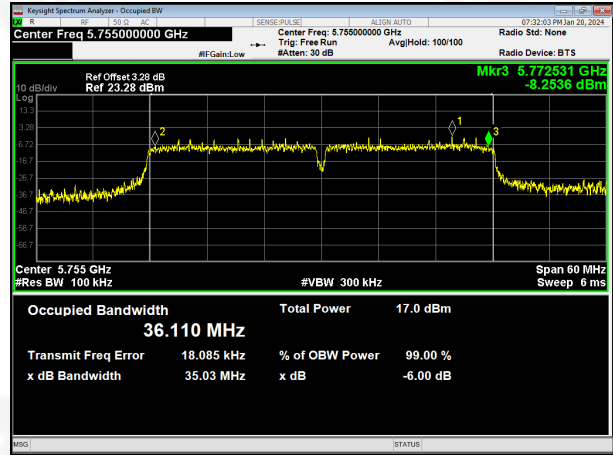

(802.11n20) 6dB Bandwidth plot on channel 157

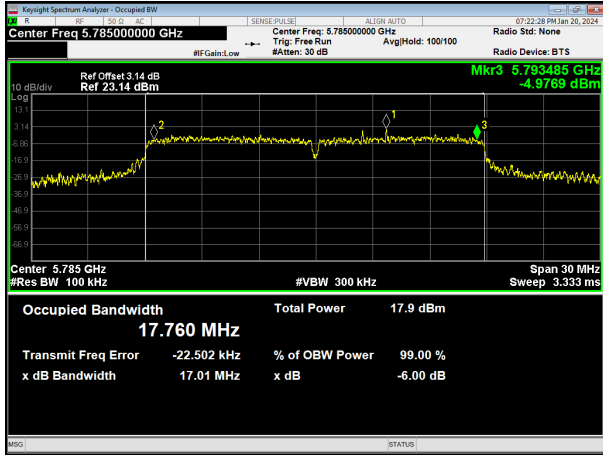

(802.11n40) 6dB Bandwidth plot on channel 159

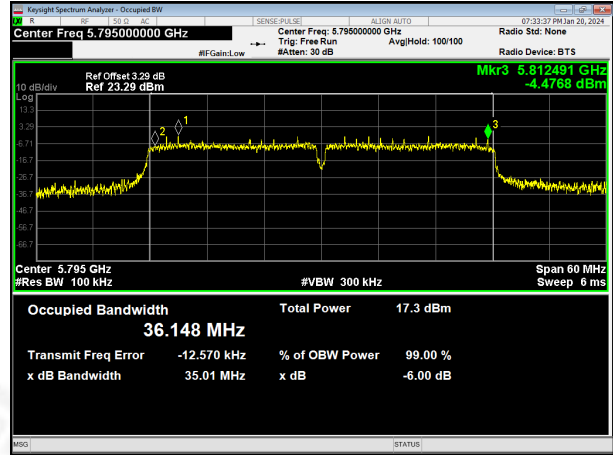

(802.11n20) 6dB Bandwidth plot on channel 165

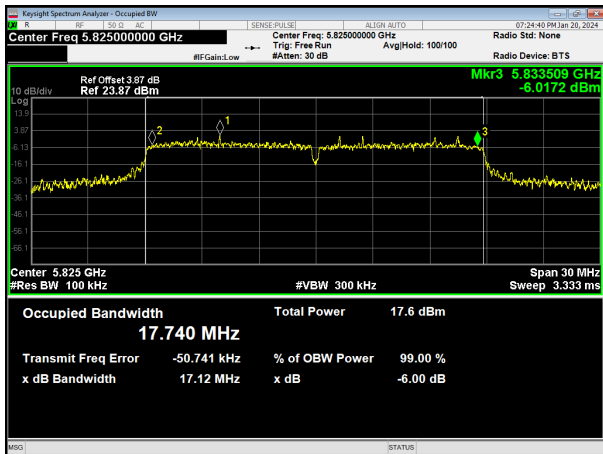



5.8G Test plot

(802.11ac20) 6dB Bandwidth plot on channel 149

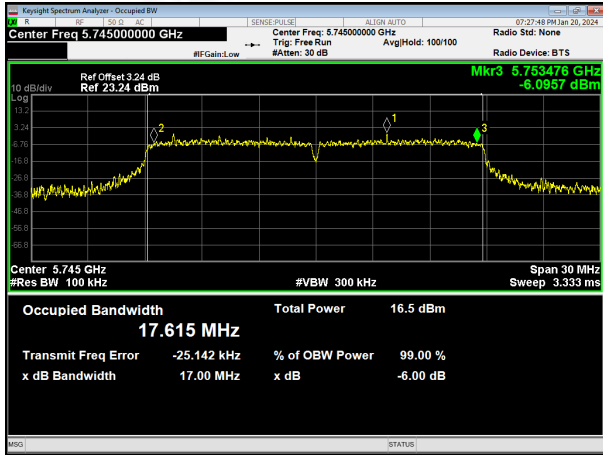

(802.11ac40) PSD plot on channel 151

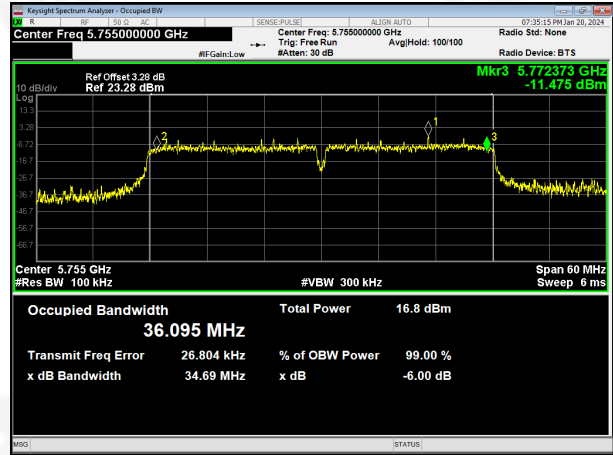

(802.11ac20) 6dB Bandwidth plot on channel 157

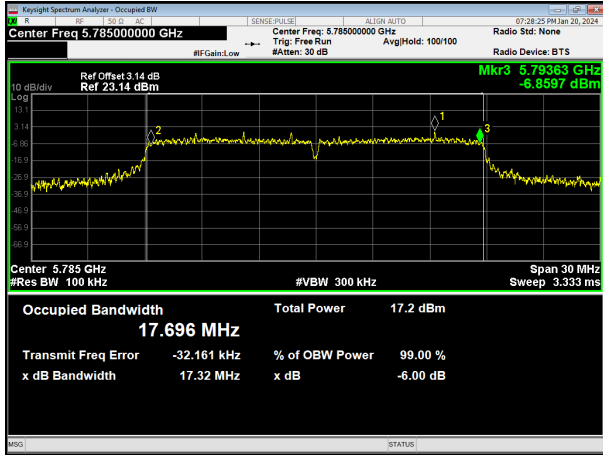

(802.11ac40) PSD plot on channel 159

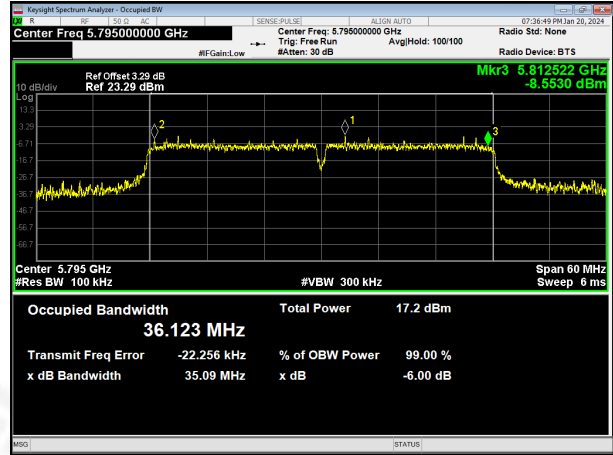

(802.11ac20) 6dB Bandwidth plot on channel 165

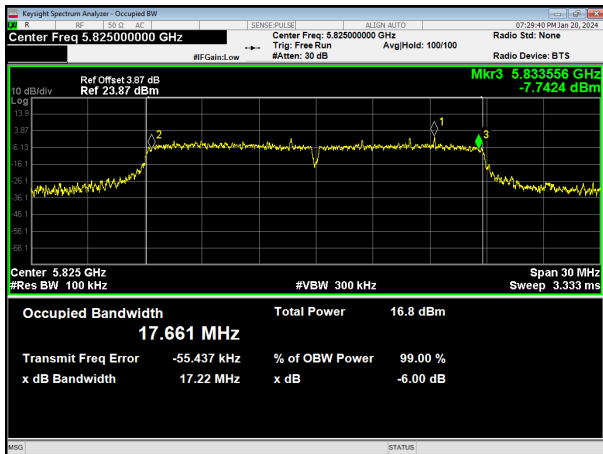

(802.11ac80) PSD plot on channel 155

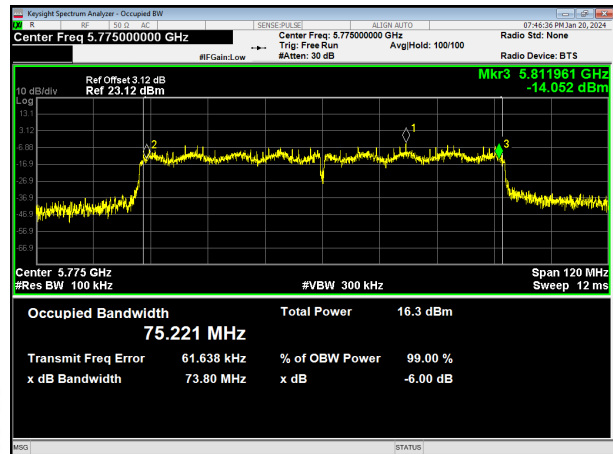



7. MAXIMUM CONDUCTED OUTPUT POWER

7.1 PPLIED PROCEDURES / LIMIT

According to FCC §15.407

The maximum conducted output power should not exceed:

Frequency Band(MHz)	Limit
5150~5250	250mW
5725~5850	1W

7.2 TEST PROCEDURE

The EUT was directly connected to the Power meter

1. Device Configuration

If possible, configure or modify the operation of the EUT so that it transmits continuously at its maximum power control level (see section II.B.).

a) The intent is to test at 100 percent duty cycle; however a small reduction in duty cycle (to no lower than 98 percent) is permitted if required by the EUT for amplitude control purposes. Manufacturers are expected to provide software to the test lab to permit such continuous operation.

b) If continuous transmission (or at least 98 percent duty cycle) cannot be achieved due to hardware limitations (e.g., overheating), the EUT shall be operated at its maximum power control level with the transmit duration as long as possible and the duty cycle as high as possible.

2. Measurement using a Spectrum Analyzer or EMI Receiver (SA)

Measurement of maximum conducted output power using a spectrum analyzer requires integrating the spectrum across a frequency span that encompasses, at a minimum, either the EBW or the 99-percent occupied bandwidth of the signal. However, the EBW must be used to determine bandwidth dependent limits on maximum conducted output power in accordance with § 15.407(a).

a) The test method shall be selected as follows: (i) Method SA-1 or SA-1 Alternative (averaging with the EUT transmitting at full power throughout each sweep) shall be applied if either of the following conditions can be satisfied:

- The EUT transmits continuously (or with a duty cycle ≥ 98 percent).
- Sweep triggering or gating can be implemented in a way that the device transmits at the maximum power control level throughout the duration of each of the instrument sweeps to be averaged. This condition can generally be achieved by triggering the instrument's sweep if the duration of the sweep (with the analyzer configured as in Method SA-1, below) is equal to or shorter than the duration T of each transmission from the EUT and if those transmissions exhibit full power throughout their durations.

(ii) Method SA-2 or SA-2 Alternative (averaging across on and off times of the EUT transmissions, followed by duty cycle correction) shall be applied if the conditions of (i) cannot be achieved and the transmissions exhibit a constant duty cycle during the measurement duration. Duty cycle will be considered to be constant if variations are less than ± 2 percent.

(iii) Method SA-3 (RMS detection with max hold) or SA-3 Alternative (reduced VBW with max hold) shall be applied if the conditions of (i) and (ii) cannot be achieved.

b) Method SA-1 (trace averaging with the EUT transmitting at full power throughout each sweep): (i) Set span to encompass the entire emission bandwidth (EBW) (or, alternatively, the entire 99% occupied bandwidth) of the signal.

(ii) Set RBW = 1 MHz.

(iii) Set VBW ≥ 3 MHz.

(iv) Number of points in sweep ≥ 2 Span / RBW. (This ensures that bin-to-bin spacing is \leq RBW/2, so that narrowband signals are not lost between frequency bins.)

(v) Sweep time = auto.

(vi) Detector = RMS (i.e., power averaging), if available. Otherwise, use sample detector mode.

(vii) If transmit duty cycle < 98 percent, use a video trigger with the trigger level set to enable triggering only on full power pulses. Transmitter must operate at maximum power control level for the entire duration of every sweep. If the EUT transmits continuously (i.e., with no off intervals) or at duty cycle ≥ 98 percent, and if each transmission is entirely at the maximum power control level, then the trigger shall be set to "free run".

(viii) Trace average at least 100 traces in power averaging (i.e., RMS) mode.



(ix) Compute power by integrating the spectrum across the EBW (or, alternatively, the entire 99% occupied bandwidth) of the signal using the instrument's band power measurement function with band limits set equal to the EBW (or occupied bandwidth) band edges. If the instrument does not have a band power function, sum the spectrum

7.3 DEVIATION FROM STANDARD

No deviation.

7.4 TEST SETUP



7.5 EUT OPERATION CONDITIONS

The EUT tested system was configured as the statements of 2.4 Unless otherwise a special operating condition is specified in the follows during the testing.



7.6 TEST RESULTS

Temperature :	26 °C	Relative Humidity :	54%
Pressure :	1012 hPa	Test Voltage :	DC 24V
Test Band :	5.2G		

802.11 a Mode						
Test Channel	Frequency (MHz)	Output power (dBm)	duty cycle Factor (dB)	Total power (dBm)	Limit (dBm)	Result
CH36	5180	9.408	2.41	11.818	23.98	Pass
CH40	5200	8.935	2.41	11.345	23.98	Pass
CH48	5240	9.487	2.41	11.897	23.98	Pass
802.11 n20 Mode						
Test Channel	Frequency (MHz)	Output power (dBm)	duty cycle Factor (dB)	Total power (dBm)	Limit (dBm)	Result
CH36	5180	8.872	2.58	11.452	23.98	Pass
CH40	5200	8.509	2.58	11.089	23.98	Pass
CH48	5240	8.809	2.58	11.389	23.98	Pass
802.11 n40 Mode						
Test Channel	Frequency (MHz)	Output power (dBm)	duty cycle Factor (dB)	Total power (dBm)	Limit (dBm)	Result
CH38	5190	7.332	2.55	9.882	23.98	Pass
CH46	5230	7.366	2.55	9.916	23.98	Pass
802.11 ac20 Mode						
Test Channel	Frequency (MHz)	Output power (dBm)	duty cycle Factor (dB)	Total power (dBm)	Limit (dBm)	Result
CH36	5180	7.930	2.55	10.48	23.98	Pass
CH40	5200	8.027	2.55	10.577	23.98	Pass
CH48	5240	8.187	2.55	10.737	23.98	Pass
802.11 ac40 Mode						
Test Channel	Frequency (MHz)	Output power (dBm)	duty cycle Factor (dB)	Total power (dBm)	Limit (dBm)	Result
CH38	5190	6.374	4.17	10.544	23.98	Pass
CH46	5230	5.969	4.17	10.139	23.98	Pass
802.11 ac80 Mode						
Test Channel	Frequency (MHz)	Output power (dBm)	duty cycle Factor (dB)	Total power (dBm)	Limit (dBm)	Result
CH42	5210	3.457	6.26	9.717	23.98	Pass

Note: duty cycle Factor see page 86.



Temperature :	26 °C	Relative Humidity :	54%
Pressure :	1012 hPa	Test Voltage :	DC 24V
Test Band :	5.8G		

802.11 a Mode						
Test Channel	Frequency (MHz)	Output power (dBm)	duty cycle Factor (dB)	Total power (dBm)	Limit (dBm)	Result
CH149	5745	9.451	2.48	11.931	30	Pass
CH157	5785	9.995	2.48	12.475	30	Pass
CH165	5825	9.823	2.48	12.303	30	Pass
802.11 n20 Mode						
Test Channel	Frequency (MHz)	Output power (dBm)	duty cycle Factor (dB)	Total power (dBm)	Limit (dBm)	Result
CH149	5745	9.711	2.55	12.261	30	Pass
CH157	5785	10.079	2.55	12.629	30	Pass
CH165	5825	9.625	2.55	12.175	30	Pass
802.11 n40 Mode						
Test Channel	Frequency (MHz)	Output power (dBm)	duty cycle Factor (dB)	Total power (dBm)	Limit (dBm)	Result
CH151	5755	7.360	4.14	11.500	30	Pass
CH159	5795	7.949	4.14	12.089	30	Pass
802.11 ac20 Mode						
Test Channel	Frequency (MHz)	Output power (dBm)	duty cycle Factor (dB)	Total power (dBm)	Limit (dBm)	Result
CH149	5745	8.474	2.60	11.074	30	Pass
CH157	5785	9.547	2.60	12.147	30	Pass
CH165	5825	8.733	2.60	11.333	30	Pass
802.11 ac40 Mode						
Test Channel	Frequency (MHz)	Output power (dBm)	duty cycle Factor (dB)	Total power (dBm)	Limit (dBm)	Result
CH151	5755	7.253	4.14	11.393	30	Pass
CH159	5795	7.644	4.14	11.784	30	Pass
802.11 ac80 Mode						
Test Channel	Frequency (MHz)	Output power (dBm)	duty cycle Factor (dB)	Total power (dBm)	Limit (dBm)	Result
CH155	5775	4.901	6.27	11.171	30	Pass

Note: duty cycle Factor see page 90.



8.OUT OF BAND EMISSIONS

8.1 APPLICABLE STANDARD

According to FCC §15.407(b)

Undesirable emission limits. Except as shown in paragraph (b)(7) of this section, the maximum emissions outside of the frequency bands of operation shall be attenuated in accordance with the following limits:

(1) For transmitters operating in the 5.15-5.25 GHz band: All emissions outside of the 5.15-5.35 GHz band shall not exceed an e.i.r.p. of -27 dBm/MHz.

(2)

(i) All emissions shall be limited to a level of -27 dBm/MHz at 75 MHz or more above or below the band edge increasing linearly to 10 dBm/MHz at 25 MHz above or below the band edge, and from 25 MHz above or below the band edge increasing linearly to a level of 15.6 dBm/MHz at 5 MHz above or below the band edge, and from 5 MHz above or below the band edge increasing linearly to a level of 27 dBm/MHz at the band edge.

8.2 TEST PROCEDURE

1. Check the calibration of the measuring instrument using either an internal calibrator or a known signal from an external generator.
2. Position the EUT without connection to measurement instrument. Turn on the EUT and connect its antenna terminal to measurement instrument via a low loss cable. Then set it to any one measured frequency within its operating range, and make sure the instrument is operated in its linear range.
3. Set RBW of spectrum analyzer to 1 MHz with a convenient frequency span.
4. Measure the highest amplitude appearing on spectral display and set it as a reference level. Plot the graph with marking the highest point and edge frequency.
5. Repeat above procedures until all measured frequencies were complete.

8.3 DEVIATION FROM STANDARD

No deviation.

8.4 TEST SETUP

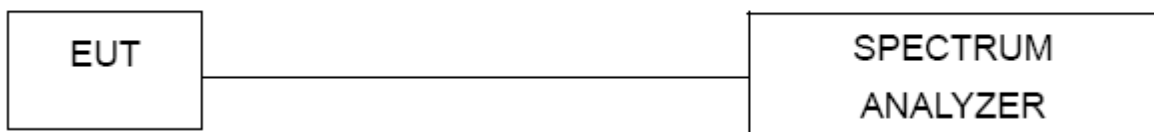

8.5 EUT OPERATION CONDITIONS

The EUT tested system was configured as the statements of 2.4 Unless otherwise a special operating condition is specified in the follows during the testing.