



FCC TEST REPORT

FCC ID:2A8JV-P941AP

Report Number.....: **ZKT-2303302223E-1**
Date of Test.....: Apr. 06, 2023 to Apr. 12, 2023
Date of issue.....: Apr. 13, 2023
Total number of pages.....: 37
Test Result: PASS

Testing Laboratory.....: Shenzhen ZKT Technology Co., Ltd.
Address: 1/F, No. 101, Building B, No. 6, Tangwei Community Industrial Avenue, Fuhai Street, Bao'an District, Shenzhen, China

Applicant's name: Guangzhou Munbyn Information Technology Co, Ltd.
Address: 329 3rd Floor, Tairong Business Center, No.63 Xizeng Road, Liwan District, Guangzhou

Manufacturer's name: Xiamen Print Future Technology Co.,Ltd.
Address: Area C, Room 502, No.17 kengping Road, GuanKou Town, Jimei District, Xiamen City

Test specification:
Standard.....: FCC CFR Title 47 Part 15 Subpart C Section 15.247
ANSI C63.10:2013
Test procedure.....: /
Non-standard test method: N/A

Test Report Form No.....: TRF-EL-111_V0
Test Report Form(s) Originator.....: ZKT Testing
Master TRF: Dated: 2020-01-06

This device described above has been tested by ZKT, and the test results show that the equipment under test (EUT) is in compliance with the FCC requirements. And it is applicable only to the tested sample identified in the report.
This report shall not be reproduced except in full, without the written approval of ZKT, this document may be altered or revised by ZKT, personal only, and shall be noted in the revision of the document.

Product name.....: Thermal Label Printer
Trademark: N/A
Model/Type reference.....: ITPP941AP
ITPP941AP Pro, ITPP942AP, ITPP44A, ITPP44A Pro
Ratings.....: Input: DC 24V/2A, 48W
AC/DC Adapter:100-240V, 50/60Hz, 2.0A



Testing procedure and testing location:

Testing Laboratory.....: **Shenzhen ZKT Technology Co., Ltd.**

Address.....: 1/F, No. 101, Building B, No. 6, Tangwei Community Industrial Avenue, Fuhai Street, Bao'an District, Shenzhen, China

Tested by (name + signature).....: Jim Liu

Reviewer (name + signature).....: Jackson Fang

Approved (name + signature).....: Lake Xie





Table of Contents

Page

| | |
|---|-----------|
| 1.VERSION | 5 |
| 2.SUMMARY OF TEST RESULTS | 6 |
| 2.1 TEST FACILITY | 7 |
| 2.2 MEASUREMENT UNCERTAINTY | 7 |
| 3. GENERAL INFORMATION | 8 |
| 3.1 GENERAL DESCRIPTION OF EUT | 8 |
| 3.2 DESCRIPTION OF TEST MODES | 9 |
| 3.3 BLOCK DIGRAM SHOWING THE CONFIGURATION OF SYSTEM TESTED | 9 |
| 3.4 DESCRIPTION OF SUPPORT UNITS(CONDUCTED MODE) | 9 |
| 3.5 EQUIPMENTS LIST FOR ALL TEST ITEMS | 10 |
| 4. EMC EMISSION TEST | 12 |
| 4.1 CONDUCTED EMISSION MEASUREMENT | 12 |
| 4.1.1 1POWER LINE CONDUCTED EMISSION LIMITS | 12 |
| 4.1.2 TEST PROCEDURE | 12 |
| 4.1.3 DEVIATION FROM TEST STANDARD | 12 |
| 4.1.4 TEST SETUP | 13 |
| 4.1.5 EUT OPERATING CONDITIONS | 13 |
| 4.1.6 TEST RESULTS | 13 |
| 4.2 RADIATED EMISSION MEASUREMENT | 14 |
| 4.2.1 RADIATED EMISSION LIMITS | 16 |
| 4.2.2 TEST PROCEDURE | 17 |
| 4.2.3 DEVIATION FROM TEST STANDARD | 17 |
| 4.2.4 TEST SETUP | 17 |
| 4.2.5 EUT OPERATING CONDITIONS | 18 |
| 5.RADIATED BAND EMISSION MEASUREMENT | 23 |
| 5.1 TEST REQUIREMENT: | 23 |
| 5.2 TEST PROCEDURE | 23 |
| 5.3 DEVIATION FROM TEST STANDARD | 23 |
| 5.4 TEST SETUP | 24 |
| 5.5 EUT OPERATING CONDITIONS | 24 |
| 5.6 TEST RESULT | 25 |
| 6.POWER SPECTRAL DENSITY TEST | 26 |
| 6.1 APPLIED PROCEDURES / LIMIT | 26 |
| 6.2 TEST PROCEDURE | 26 |
| 6.3 DEVIATION FROM STANDARD | 26 |
| 6.4 TEST SETUP | 26 |



| Table of Contents | Page |
|---|-------------|
| 6.5 EUT OPERATION CONDITIONS | 26 |
| 6.6 TEST RESULTS | 27 |
| 7. CHANNEL BANDWIDTH | 29 |
| 7.1 APPLIED PROCEDURES / LIMIT | 29 |
| 7.2 TEST PROCEDURE | 29 |
| 7.3 DEVIATION FROM STANDARD | 29 |
| 7.4 TEST SETUP | 29 |
| 7.5 EUT OPERATION CONDITIONS | 29 |
| 7.6 TEST RESULTS | 30 |
| 8. PEAK OUTPUT POWER TEST | 32 |
| 8.1 APPLIED PROCEDURES / LIMIT | 32 |
| 8.2 TEST PROCEDURE | 32 |
| 8.3 DEVIATION FROM STANDARD | 32 |
| 8.4 TEST SETUP | 32 |
| 8.5 EUT OPERATION CONDITIONS | 32 |
| 8.6 TEST RESULTS | 32 |
| 9. CONDUCTED BAND EDGE AND SPURIOUS EMISSION | 33 |
| 9.1 APPLICABLE STANDARD | 33 |
| 9.2 TEST PROCEDURE | 33 |
| 9.3 DEVIATION FROM STANDARD | 33 |
| 9.4 TEST SETUP | 33 |
| 9.5 EUT OPERATION CONDITIONS | 33 |
| 10. ANTENNA REQUIREMENT | 36 |
| 11. TEST SETUP PHOTO | 37 |
| 12. EUT CONSTRUCTIONAL DETAILS | 37 |



1.VERSION

| Report No. | Version | Description | Approved |
|-------------------|---------|-------------------------|---------------|
| ZKT-2303302223E-1 | Rev.01 | Initial issue of report | Apr. 13, 2023 |
| | | | |



2. SUMMARY OF TEST RESULTS

Test procedures according to the technical standards:

| FCC Part15 (15.247) , Subpart C | | | |
|---------------------------------|----------------------------------|----------|--------|
| Standard Section | Test Item | Judgment | Remark |
| FCC part 15.203/15.247 (c) | Antenna requirement | PASS | |
| FCC part 15.207 | AC Power Line Conducted Emission | PASS | |
| FCC part 15.247 (b)(3) | Conducted Peak Output Power | PASS | |
| FCC part 15.247 (a)(2) | -6dB Channel Bandwidth | PASS | |
| FCC part 15.247 (e) | Power Spectral Density | PASS | |
| FCC part 15.247(d) | Band Edge | PASS | |
| FCC part 15.205/15.209 | Spurious Emission | PASS | |

NOTE:

(1)“N/A” denotes test is not applicable in this Test Report



2.1 TEST FACILITY

Shenzhen ZKT Technology Co., Ltd.
Add. : 1/F, No. 101, Building B, No. 6, Tangwei Community Industrial Avenue, Fuhai Street, Bao'an District, Shenzhen, China

FCC Test Firm Registration Number: 692225
Designation Number: CN1299
IC Registered No.: 27033

2.2 MEASUREMENT UNCERTAINTY

The reported uncertainty of measurement $y \pm U$ · where expanded uncertainty U is based on a standard uncertainty multiplied by a coverage factor of $k=2$ · providing a level of confidence of approximately 95 % .

| No. | Item | Uncertainty |
|-----|---|-------------|
| 1 | 3m chamber Radiated spurious emission(9KHz-30MHz) | U=4.5dB |
| 2 | 3m chamber Radiated spurious emission(30MHz-1GHz) | U=4.8dB |
| 3 | 3m chamber Radiated spurious emission(1GHz-6GHz) | U=4.9dB |
| 4 | 3m chamber Radiated spurious emission(6GHz-40GHz) | U=5.0dB |
| 5 | Conducted disturbance | U=3.2dB |
| 6 | RF Band Edge | U=1.68dB |
| 7 | RF power conducted | U=1.86dB |
| 8 | RF conducted Spurious Emission | U=2.2dB |
| 9 | RF Occupied Bandwidth | U=1.8MHz |
| 10 | RF Power Spectral Density | U=1.75dB |
| 11 | humidity uncertainty | U=5.3% |
| 12 | Temperature uncertainty | U=0.59°C |



3. GENERAL INFORMATION

3.1 GENERAL DESCRIPTION OF EUT

| | |
|--------------------------|--|
| Product Name: | Thermal Label Printer |
| Model No.: | ITPP941AP |
| Model Different.: | Only the model name is different. |
| Serial No.: | ITPP941AP Pro, ITPP942AP, ITPP44A, ITPP44A Pro |
| Hardware Version: | H1.0 |
| Software Version: | S1.0 |
| Sample(s) Status: | Engineer sample |
| Operation Frequency: | 2402MHz~2480MHz |
| Channel Numbers: | 40 |
| Channel Separation: | 2MHz |
| Modulation Type: | GFSK |
| Antenna Type: | PCB antenna |
| Antenna gain: | 3.3dBi |
| Power supply: | Input: DC 24V/2A, 48W |
| SWITCHING POWER ADAPTER: | AC 100-240V, 50/60Hz, 2.0A |

| Operation Frequency each of channel | | | | | | | |
|-------------------------------------|-----------|---------|-----------|---------|-----------|---------|-----------|
| Channel | Frequency | Channel | Frequency | Channel | Frequency | Channel | Frequency |
| 1 | 2402 MHz | 11 | 2422 MHz | 21 | 2442 MHz | 31 | 2462 MHz |
| 2 | 2404 MHz | 12 | 2424 MHz | 22 | 2444 MHz | 32 | 2464 MHz |
| 3 | 2406 MHz | 13 | 2426 MHz | 23 | 2446 MHz | 33 | 2466 MHz |
| 4 | 2408 MHz | 14 | 2428 MHz | 24 | 2448 MHz | 34 | 2468 MHz |
| 5 | 2410 MHz | 15 | 2430 MHz | 25 | 2450 MHz | 35 | 2470 MHz |
| 6 | 2412 MHz | 16 | 2432 MHz | 26 | 2452 MHz | 36 | 2472 MHz |
| 7 | 2414 MHz | 17 | 2434 MHz | 27 | 2454 MHz | 37 | 2474 MHz |
| 8 | 2416 MHz | 18 | 2436 MHz | 28 | 2456 MHz | 38 | 2476 MHz |
| 9 | 2418 MHz | 19 | 2438 MHz | 29 | 2458 MHz | 39 | 2478 MHz |
| 10 | 2420 MHz | 20 | 2440 MHz | 30 | 2460 MHz | 40 | 2480 MHz |

Note:

In section 15.31(m), regards to the operating frequency range over 10 MHz, the Lowest frequency, the middle frequency, and the highest frequency of channel were selected to perform the test, and the selected channel see below:

| Channel | Frequency |
|---------------------|-----------|
| The lowest channel | 2402MHz |
| The middle channel | 2440MHz |
| The Highest channel | 2480MHz |



3.2 DESCRIPTION OF TEST MODES

| | |
|---|--|
| Transmitting mode | Keep the EUT in continuously transmitting mode |
| Charging mode | Keep the EUT in Charging mode. |
| Remark: During the test, the test voltage was tuned from 85% to 115% of the nominal rated supply voltage, and found that the worst case was under the nominal rated supply condition. So the report just shows that condition's data. | |

| | |
|-------------------|--------------------|
| Test Software | Ampak RF Test Tool |
| Power level setup | <0dBm |

3.3 BLOCK DIGRAM SHOWING THE CONFIGURATION OF SYSTEM TESTED

Conducted Emission

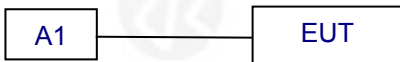

Radiated Emission

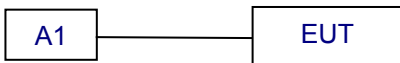

Conducted Spurious

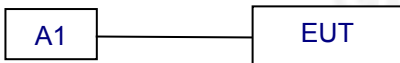

3.4 DESCRIPTION OF SUPPORT UNITS(CONDUCTED MODE)

The EUT has been tested as an independent unit together with other necessary accessories or support units. The following support units or accessories were used to form a representative test configuration during the tests.

| Item | Equipment | Mfr/Brand | Model/Type No. | Series No. | Note |
|------|-----------------------|-----------|----------------|------------|-----------|
| E-1 | Thermal Label Printer | N/A | ITPP941AP | See page 8 | EUT |
| A1 | AC/DC Adapter | GVE | GM53-240200-F | N/A | Auxiliary |
| | | | | | |

| Item | Shielded Type | Ferrite Core | Length | Note |
|------|---------------|--------------|--------|------|
| | | | | |
| | | | | |

Note:

- (1) The support equipment was authorized by Declaration of Confirmation.
- (2) For detachable type I/O cable should be specified the length in cm in 『Length』 column.



3.5 EQUIPMENTS LIST FOR ALL TEST ITEMS

Radiation Test equipment

| Item | Equipment | Manufacturer | Type No. | Serial No. | Last calibration | Calibrated until |
|------|-----------------------------------|----------------|-----------------|-------------------|------------------|------------------|
| 1 | Spectrum Analyzer (9kHz-26.5GHz) | KEYSIGHT | 9020A | MY55370835 | Oct. 28, 2022 | Oct. 27, 2023 |
| 2 | Spectrum Analyzer (10kHz-39.9GHz) | R&S | FSQ | 100363 | Oct. 28, 2022 | Oct. 27, 2023 |
| 3 | EMI Test Receiver (9kHz-7GHz) | R&S | ESCI7 | 101169 | Oct. 28, 2022 | Oct. 27, 2023 |
| 4 | Bilog Antenna (30MHz-1500MHz) | Schwarzbeck | VULB9168 | N/A | Nov. 02, 2022 | Nov. 01, 2023 |
| 5 | Horn Antenna (1GHz-18GHz) | Agilent | AH-118 | 071145 | Nov. 01, 2022 | Oct. 31, 2023 |
| 6 | Horn Antenna (15GHz-40GHz) | A.H.System | SAS-574 | 588 | Oct. 28, 2022 | Oct. 27, 2023 |
| 7 | Loop Antenna | TESEQ | HLA6121 | 58357 | Nov. 01, 2022 | Oct. 31, 2023 |
| 8 | Amplifier (30-1000MHz) | EM Electronics | EM330 Amplifier | 060747 | Nov. 15, 2022 | Nov. 14, 2023 |
| 9 | Amplifier (1GHz-26.5GHz) | Agilent | 8449B | 3008A00315 | Oct. 28, 2022 | Oct. 27, 2023 |
| 10 | Amplifier (500MHz-40GHz) | 全聚达 | DLE-161 | 097 | Oct. 28, 2022 | Oct. 27, 2023 |
| 11 | Test Cable | N/A | R-01 | N/A | Oct. 28, 2022 | Oct. 27, 2023 |
| 12 | Test Cable | N/A | R-02 | N/A | Oct. 28, 2022 | Oct. 27, 2023 |
| 13 | Test Cable | N/A | R-03 | N/A | Oct. 28, 2022 | Oct. 27, 2023 |
| 14 | Test Cable | N/A | RF-01 | N/A | Oct. 28, 2022 | Oct. 27, 2023 |
| 15 | Test Cable | N/A | RF-02 | N/A | Oct. 28, 2022 | Oct. 27, 2023 |
| 16 | Test Cable | N/A | RF-03 | N/A | Oct. 28, 2022 | Oct. 27, 2023 |
| 17 | ESG Signal Generator | Agilent | E4421B | N/A | Oct. 21, 2022 | Oct. 20, 2023 |
| 18 | Signal Generator | Agilent | N5182A | N/A | Oct. 21, 2022 | Oct. 20, 2023 |
| 19 | Magnetic Field Probe Tester | Narda | ELT-400 | 0-0344 | Nov. 15, 2022 | Nov. 14, 2023 |
| 20 | Wideband Radio Communication Test | R&S | CMW500 | 106504 | Oct. 28, 2022 | Oct. 27, 2023 |
| 21 | MWRF Power Meter Test system | MW | MW100-RPCB | N/A | Oct. 21, 2022 | Oct. 20, 2023 |
| 22 | D.C. Power Supply | LongWei | TPR-6405D | N/A | \ | \ |
| 23 | EMC Software | Frad | EZ-EMC | Ver.EMC-CON 3A1.1 | \ | \ |
| 24 | RF Software | MW | MTS8310 | V2.0.0.0 | \ | \ |
| 25 | Turntable | MF | MF-7802BS | N/A | \ | \ |
| 26 | Antenna tower | MF | MF-7802BS | N/A | \ | \ |



Conduction Test equipment

| Item | Kind of Equipment | Manufacturer | Type No. | Serial No. | Last calibration | Calibrated until |
|------|---------------------|--------------|----------|----------------------|------------------|------------------|
| 1 | LISN | R&S | ENV216 | 101471 | Oct. 21, 2022 | Oct. 20, 2023 |
| 2 | LISN | CYBERTEK | EM5040A | E1850400149 | Oct. 21, 2022 | Oct. 20, 2023 |
| 3 | Test Cable | N/A | C-01 | N/A | Oct. 21, 2022 | Oct. 20, 2023 |
| 4 | Test Cable | N/A | C-02 | N/A | Oct. 21, 2022 | Oct. 20, 2023 |
| 5 | Test Cable | N/A | C-03 | N/A | Oct. 21, 2022 | Oct. 20, 2023 |
| 6 | EMI Test Receiver | R&S | ESCI3 | 101393 | Oct. 28, 2022 | Oct. 27, 2023 |
| 7 | Triple-Loop Antenna | N/A | RF300 | N/A | Oct. 28, 2022 | Oct. 27, 2023 |
| 8 | Absorbing Clamp | DZ | ZN23201 | 15034 | Oct. 31, 2022 | Oct. 30, 2023 |
| 9 | EMC Software | Frad | EZ-EMC | Ver.EMC-CON 3A1.1 | \ | \ |



4. EMC EMISSION TEST

4.1 CONDUCTED EMISSION MEASUREMENT

| | |
|-----------------------|--------------------------------------|
| Test Requirement: | FCC Part15 C Section 15.207 |
| Test Method: | ANSI C63.10:2013 |
| Test Frequency Range: | 150KHz to 30MHz |
| Receiver setup: | RBW=9KHz, VBW=30KHz, Sweep time=auto |

4.1.1 POWER LINE CONDUCTED EMISSION Limits

| FREQUENCY (MHz) | Limit (dBuV) | | Standard |
|-----------------|--------------|-----------|----------|
| | Quas-peak | Average | |
| 0.15 -0.5 | 66 - 56 * | 56 - 46 * | FCC |
| 0.50 -5.0 | 56.00 | 46.00 | FCC |
| 5.0 -30.0 | 60.00 | 50.00 | FCC |

Note:

(1) *Decreases with the logarithm of the frequency.

4.1.2 TEST PROCEDURE

- a. The EUT was placed 0.8 meters from the horizontal ground plane with EUT being connected to the power mains through a line impedance stabilization network (LISN). All other support equipments powered from additional LISN(s). The LISN provide 50 Ohm/ 50uH of coupling impedance for the measuring instrument.
- b. Interconnecting cables that hang closer than 40 cm to the ground plane shall be folded back and forth in the center forming a bundle 30 to 40 cm long.
- c. I/O cables that are not connected to a peripheral shall be bundled in the center. The end of the cable may be terminated, if required, using the correct terminating impedance. The overall length shall not exceed 1 m.
- d. LISN at least 80 cm from nearest part of EUT chassis.
- e. For the actual test configuration, please refer to the related Item –EUT Test Photos.

4.1.3 DEVIATION FROM TEST STANDARD

No deviation



4.1.4 TEST SETUP

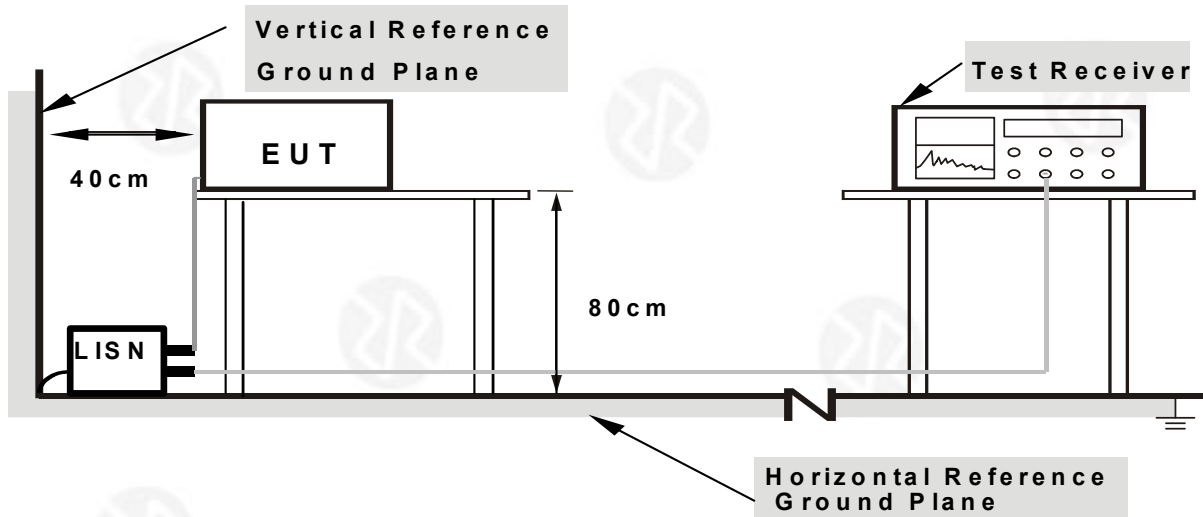

- Note:**
1. Support units were connected to second LISN.
 2. Both of LISNs (AMN) are 80 cm from EUT and at least 80 cm from other units and other metal planes

4.1.5 EUT OPERATING CONDITIONS

The EUT was configured for testing in a typical fashion (as a customer would normally use it). The EUT has been programmed to Charging during test. This operating condition was tested and used to collect the included data.

We pretest AC 120V and AC 230V, the worst voltage was AC 120V and the data recording in the report.



4.1.6 Test Result

| | | | |
|---------------|--------------|--------------------|-----|
| Temperature: | 26°C | Relative Humidity: | 54% |
| Pressure: | 101 kPa | Polarization: | L |
| Test Voltage: | AC 120V/60Hz | | |

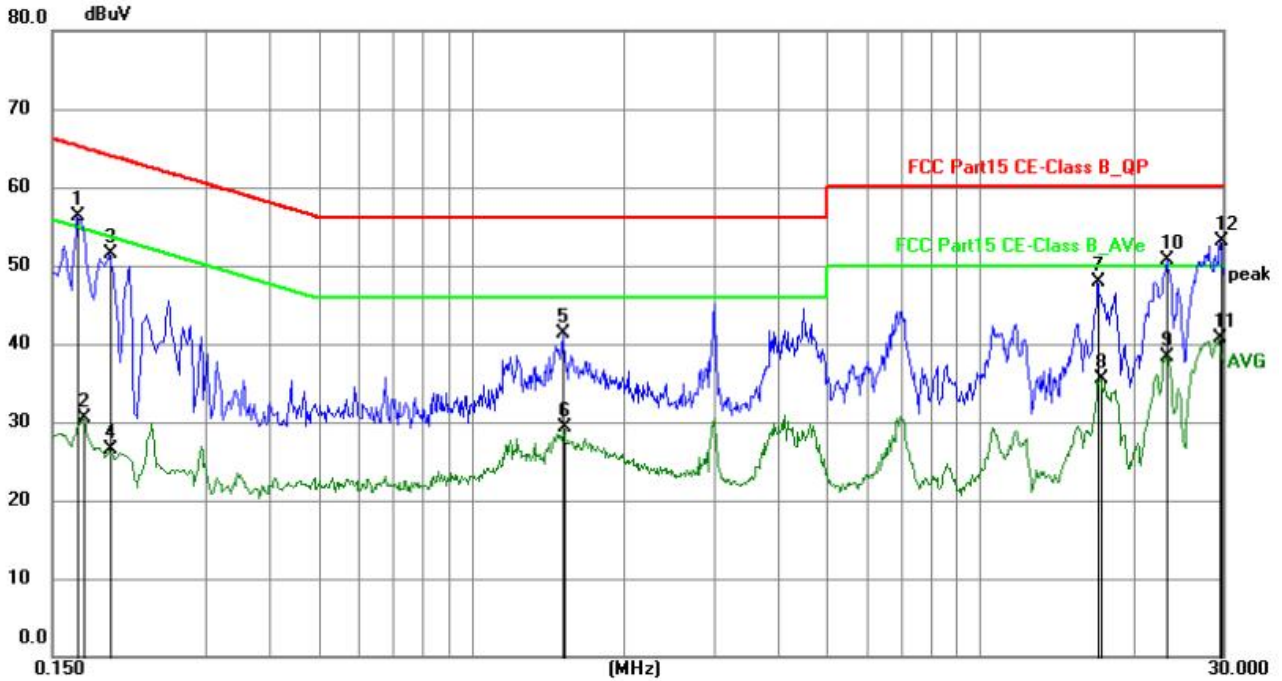

| No. | Frequency (MHz) | Reading (dBuV) | Factor (dB) | Level (dBuV) | Limit (dBuV) | Margin (dB) | Detector | P/F | Remark |
|-----|-----------------|----------------|-------------|--------------|--------------|-------------|----------|-----|--------|
| 1 | 0.1680 | 33.75 | 22.61 | 56.36 | 65.06 | -8.70 | QP | P | |
| 2 | 0.1723 | 7.95 | 22.52 | 30.47 | 54.85 | -24.38 | AVG | P | |
| 3 | 0.1949 | 29.57 | 22.03 | 51.60 | 63.83 | -12.23 | QP | P | |
| 4 | 0.1949 | 4.52 | 22.03 | 26.55 | 53.83 | -27.28 | AVG | P | |
| 5 | 1.5134 | 21.05 | 20.31 | 41.36 | 56.00 | -14.64 | QP | P | |
| 6 | 1.5267 | 9.04 | 20.31 | 29.35 | 46.00 | -16.65 | AVG | P | |
| 7 | 17.0880 | 28.36 | 19.45 | 47.81 | 60.00 | -12.19 | QP | P | |
| 8 | 17.2950 | 16.10 | 19.48 | 35.58 | 50.00 | -14.42 | AVG | P | |
| 9 | 23.1630 | 18.48 | 19.89 | 38.37 | 50.00 | -11.63 | AVG | P | |
| 10 | 23.2935 | 30.76 | 19.89 | 50.65 | 60.00 | -9.35 | QP | P | |
| 11 | 29.6610 | 20.67 | 19.96 | 40.63 | 50.00 | -9.37 | AVG | P | |
| 12 | 29.7823 | 33.13 | 19.96 | 53.09 | 60.00 | -6.91 | QP | P | |



| | | | |
|---------------|--------------|--------------------|-----|
| Temperature: | 26°C | Relative Humidity: | 54% |
| Pressure: | 101 kPa | Polarization: | N |
| Test Voltage: | AC 120V/60Hz | | |

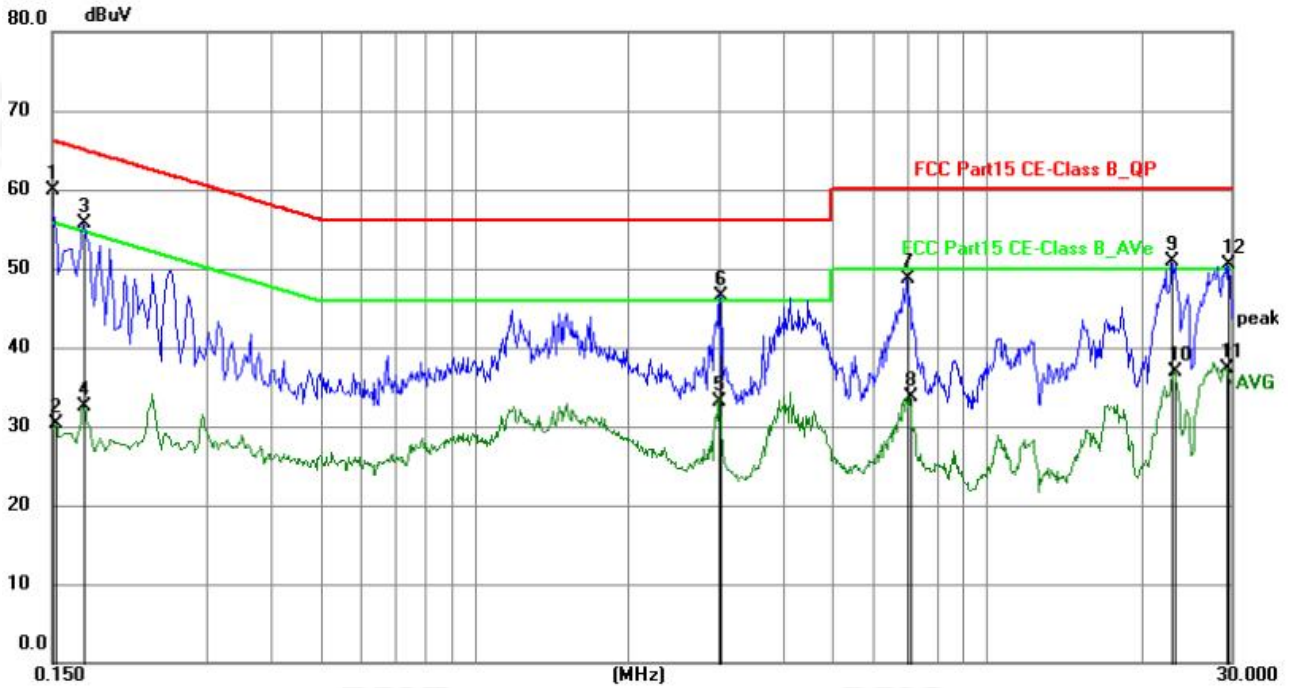

| No. | Frequency (MHz) | Reading (dBuV) | Factor (dB) | Level (dBuV) | Limit (dBuV) | Margin (dB) | Detector | P/F | Remark |
|-----|-----------------|----------------|-------------|--------------|--------------|-------------|----------|-----|--------|
| 1 | 0.1500 | 36.87 | 23.01 | 59.88 | 66.00 | -6.12 | QP | P | |
| 2 | 0.1524 | 7.44 | 22.96 | 30.40 | 55.87 | -25.47 | AVG | P | |
| 3 | 0.1723 | 33.18 | 22.52 | 55.70 | 64.85 | -9.15 | QP | P | |
| 4 | 0.1723 | 10.00 | 22.52 | 32.52 | 54.85 | -22.33 | AVG | P | |
| 5 | 2.9940 | 13.18 | 19.94 | 33.12 | 46.00 | -12.88 | AVG | P | |
| 6 | 3.0120 | 26.66 | 19.93 | 46.59 | 56.00 | -9.41 | QP | P | |
| 7 | 7.0034 | 30.11 | 18.57 | 48.68 | 60.00 | -11.32 | QP | P | |
| 8 | 7.0845 | 15.22 | 18.57 | 33.79 | 50.00 | -16.21 | AVG | P | |
| 9 | 22.9513 | 30.95 | 19.89 | 50.84 | 60.00 | -9.16 | QP | P | |
| 10 | 23.1493 | 16.94 | 19.89 | 36.83 | 50.00 | -13.17 | AVG | P | |
| 11 | 29.3143 | 17.33 | 19.95 | 37.28 | 50.00 | -12.72 | AVG | P | |
| 12 | 29.6833 | 30.57 | 19.96 | 50.53 | 60.00 | -9.47 | QP | P | |



4.2 RADIATED EMISSION MEASUREMENT

| | | | | | |
|-----------------------|-----------------------------|------------|--------|---------|------------|
| Test Requirement: | FCC Part15 C Section 15.209 | | | | |
| Test Method: | ANSI C63.10:2013 | | | | |
| Test Frequency Range: | 9kHz to 25GHz | | | | |
| Test site: | Measurement Distance: 3m | | | | |
| Receiver setup: | Frequency | Detector | RBW | VBW | Value |
| | 9KHz-150KHz | Quasi-peak | 200Hz | 600Hz | Quasi-peak |
| | 150KHz-30MHz | Quasi-peak | 9KHz | 30KHz | Quasi-peak |
| | 30MHz-1GHz | Quasi-peak | 100KHz | 300KHz | Quasi-peak |
| | Above 1GHz | Peak | 1MHz | 3MHz | Peak |
| Peak | | 1MHz | 10Hz | Average | |

4.2.1 RADIATED EMISSION LIMITS

| Frequencies (MHz) | Field Strength (micorvolts/meter) | Measurement Distance (meters) |
|-------------------|-----------------------------------|-------------------------------|
| 0.009~0.490 | 2400/F(KHz) | 300 |
| 0.490~1.705 | 24000/F(KHz) | 30 |
| 1.705~30.0 | 30 | 30 |
| 30~88 | 100 | 3 |
| 88~216 | 150 | 3 |
| 216~960 | 200 | 3 |
| Above 960 | 500 | 3 |

LIMITS OF RADIATED EMISSION MEASUREMENT

| FREQUENCY (MHz) | Limit (dBuV/m) (at 3M) | |
|-----------------|------------------------|---------|
| | PEAK | AVERAGE |
| Above 1000 | 74 | 54 |

Notes:

- (1) The limit for radiated test was performed according to FCC PART 15C.
- (2) The tighter limit applies at the band edges.
- (3) Emission level (dBuV/m)=20log Emission level (uV/m).



4.2.2 TEST PROCEDURE

- a. The measuring distance of at 3 m shall be used for measurements at frequency up to 25GHz. For frequencies above 1GHz, any suitable measuring distance may be used.
- b. The EUT was placed on the top of a rotating table 0.8 meters above the ground at a 3 meter semi-chamber test. The table was rotated 360 degrees to determine the position of the highest radiation.
- c. The height of the equipment or of the substitution antenna shall be 0.8m; above 1GHz, the height was 1.5m, the height of the test antenna shall vary between 1 m to 4 m. Both horizontal and vertical polarizations of the antenna are set to make the measurement.
- d. The initial step in collecting conducted emission data is a spectrum analyzer peak detector mode pre-scanning the measurement frequency range. Significant peaks are then marked and then Quasi Peak detector mode re-measured.
- e. If the Peak Mode measured value compliance with and lower than Quasi Peak Mode Limit, the EUT shall be deemed to meet QP Limits and then no additional QP Mode measurement performed.
- f. For the actual test configuration, please refer to the related Item –EUT Test Photos.

g. For the radiated emission test above 1GHz:

Place the measurement antenna away from each area of the EUT determined to be a source of emissions at the specified measurement distance, while keeping the measurement antenna aimed at the source of emissions at each frequency of significant emissions, with polarization oriented for maximum response.

The measurement antenna may have to be higher or lower than the EUT, depending on the radiation pattern of the emission and staying aimed at the emission source for receiving the maximum signal. The final measurement antenna elevation shall be that which maximizes the emissions. The measurement antenna elevation for maximum emissions shall be restricted to a range of heights of from 1 m to 4 m above the ground or reference ground plane.

Note:

Both horizontal and vertical antenna polarities were tested and performed pretest to three orthogonal axis. The worst case emissions were reported

4.2.3 DEVIATION FROM TEST STANDARD

No deviation

4.2.4 TEST SETUP

(A) Radiated Emission Test-Up Frequency Below 30MHz

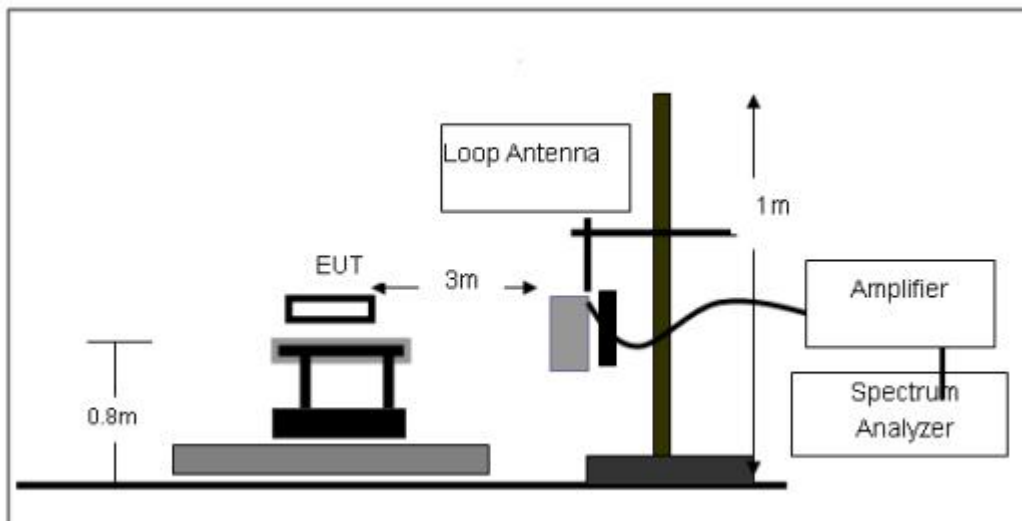



(B) Radiated Emission Test-Up Frequency 30MHz~1GHz

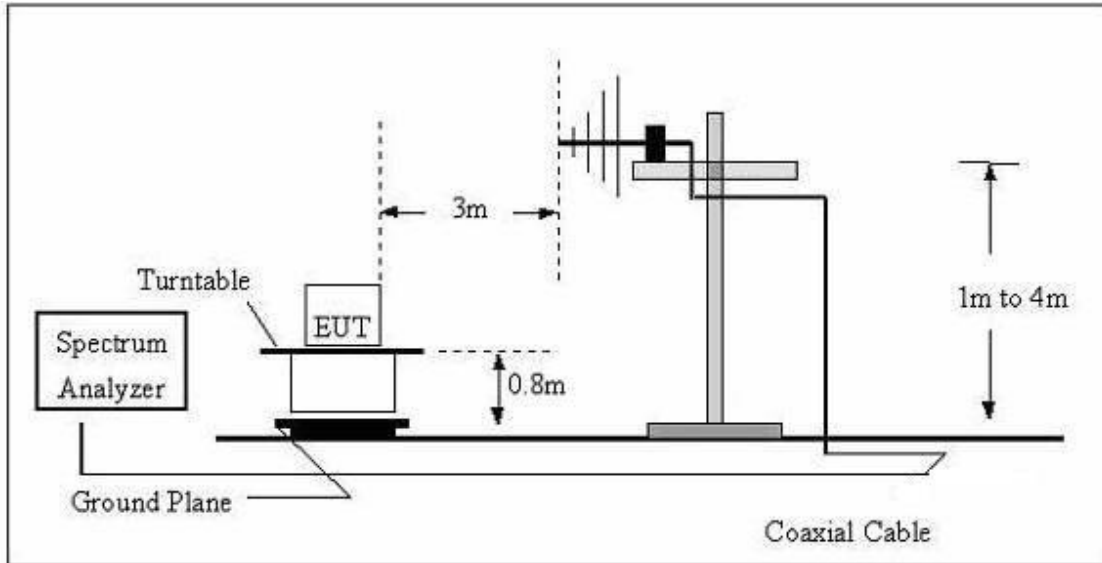

(C) Radiated Emission Test-Up Frequency Above 1GHz

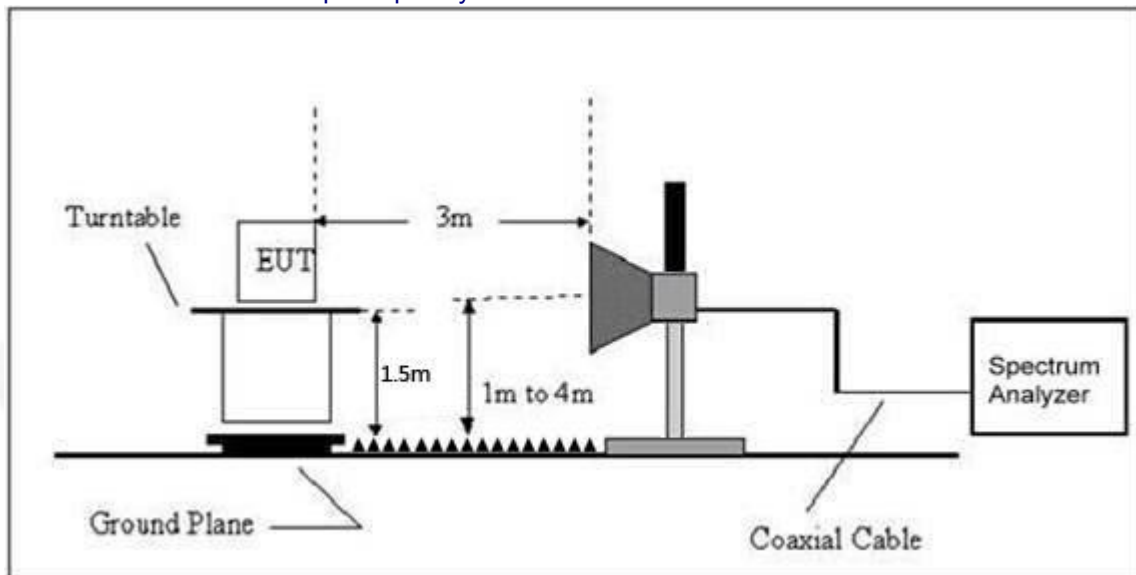

4.2.5 EUT OPERATING CONDITIONS

The EUT tested system was configured as the statements of 2.4 Unless otherwise a special operating condition is specified in the follows during the testing.

4.2.6 TEST RESULTS (Between 9KHz – 30 MHz)

The emission from 9 kHz to 30MHz was pre-tested and found the result was 20dB lower than the limit, and according to 15.31(o) & RSS-Gen 6.13, the test result no need to reported.



Between 30MHz – 1GHz

| | | | |
|---------------|---------|--------------------|------------|
| Temperature: | 26°C | Relative Humidity: | 54% |
| Pressure: | 101 kPa | Polarization: | Horizontal |
| Test Voltage: | DC 24V | | |

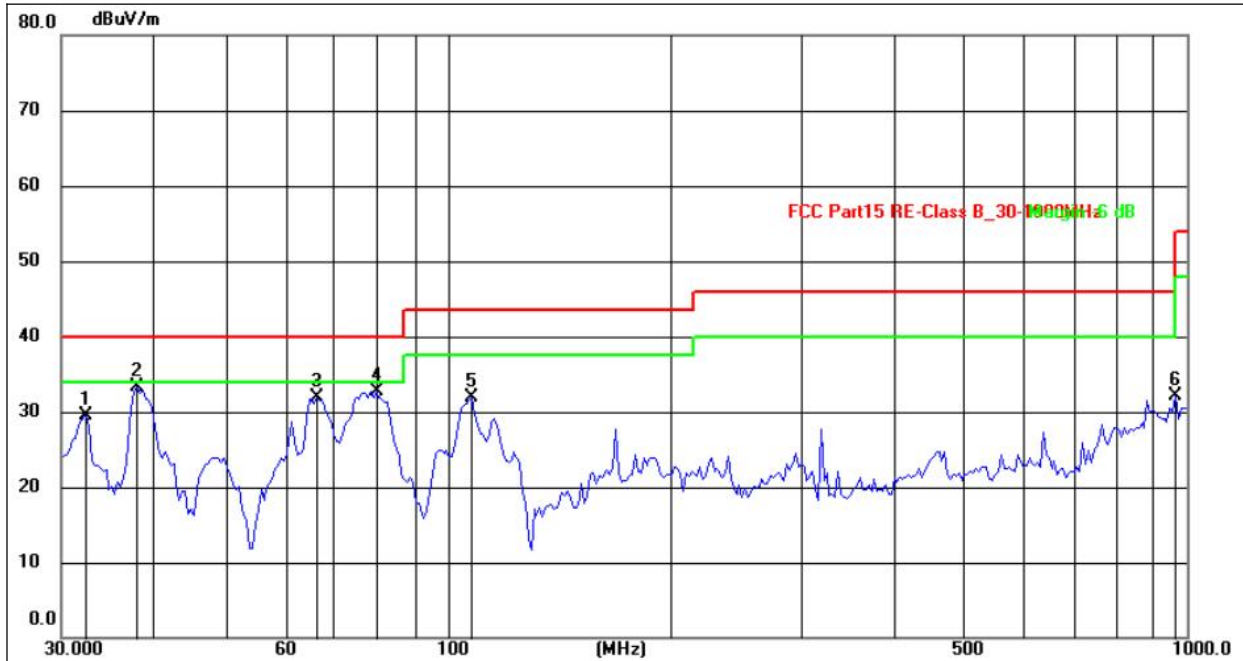

| No. | Frequency (MHz) | Reading (dBuV) | Factor (dB/m) | Level (dBuV/m) | Limit (dBuV/m) | Margin (dB) | Detector |
|-----|-----------------|----------------|---------------|----------------|----------------|-------------|----------|
| 1 | 32.4628 | 47.60 | -18.03 | 29.57 | 40.00 | -10.43 | QP |
| 2 | 38.0114 | 50.39 | -17.16 | 33.23 | 40.00 | -6.77 | QP |
| 3 | 66.6156 | 50.99 | -19.00 | 31.99 | 40.00 | -8.01 | QP |
| 4 | 80.0805 | 54.62 | -21.87 | 32.75 | 40.00 | -7.25 | QP |
| 5 | 107.8876 | 53.09 | -21.28 | 31.81 | 43.50 | -11.69 | QP |
| 6 | 965.5420 | 32.43 | -0.40 | 32.03 | 54.00 | -21.97 | QP |



| | | | |
|---------------|--------|--------------------|----------|
| Temperature: | 26°C | Relative Humidity: | 54% |
| Pressure: | 101kPa | Polarization: | Vertical |
| Test Voltage: | DC 24V | | |

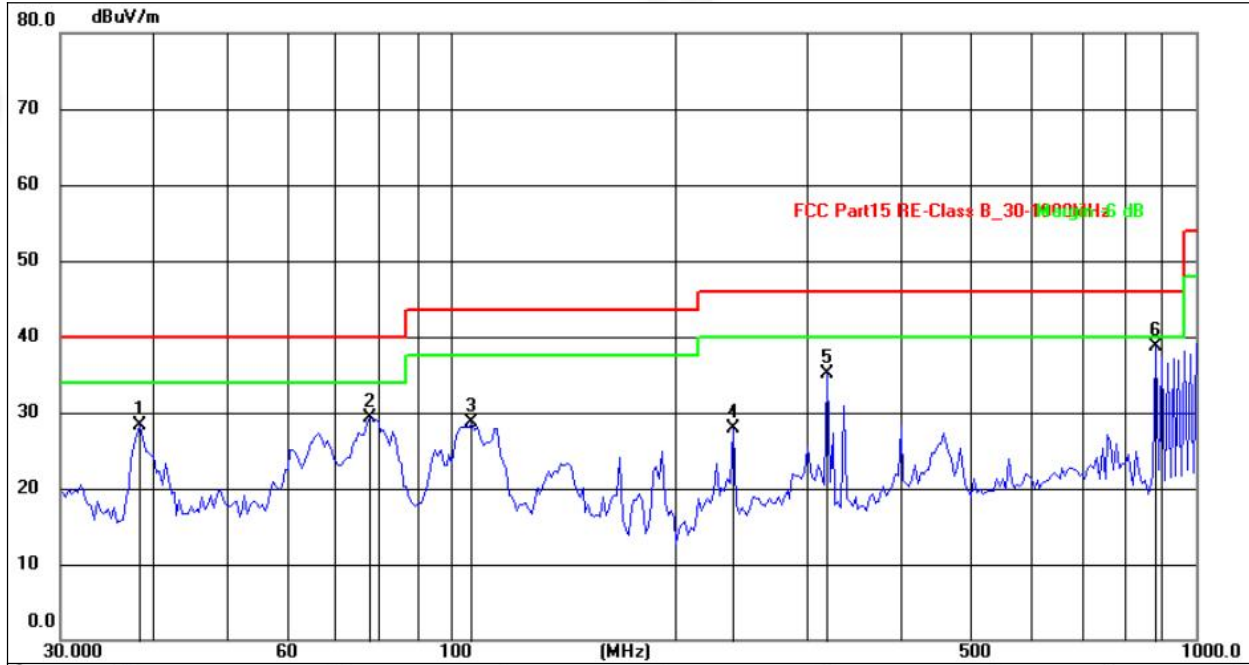

| No. | Frequency (MHz) | Reading (dBuV) | Factor (dB/m) | Level (dBuV/m) | Limit (dBuV/m) | Margin (dB) | Detector |
|-----|-----------------|----------------|---------------|----------------|----------------|-------------|----------|
| 1 | 38.3462 | 42.72 | -14.43 | 28.29 | 40.00 | -11.71 | QP |
| 2 | 78.0019 | 48.20 | -18.95 | 29.25 | 40.00 | -10.75 | QP |
| 3 | 106.9458 | 48.01 | -19.39 | 28.62 | 43.50 | -14.88 | QP |
| 4 | 239.5669 | 44.21 | -16.31 | 27.90 | 46.00 | -18.10 | QP |
| 5 | 319.9368 | 51.93 | -16.91 | 35.02 | 46.00 | -10.98 | QP |
| 6 | 884.5027 | 45.66 | -6.98 | 38.68 | 46.00 | -7.32 | QP |

Remarks:

1. Final Level = Receiver Read level + Antenna Factor + Cable Loss – Preamplifier Factor
2. The emission levels of other frequencies are very lower than the limit and not show in test report.
3. The test data shows only the worst case GFSK mode



1GHz~25GHz

| Polar (H/V) | Frequency | Meter Reading | Pre-amplifier | Cable Loss | Antenna Factor | Emission Level | Limits | Margin | Detector Type |
|---------------------|-----------|---------------|---------------|------------|----------------|----------------|----------|--------|---------------|
| | (MHz) | (dBuV) | (dB) | (dB) | (dB) | (dBuV/m) | (dBuV/m) | (dB) | |
| Low Channel:2402MHz | | | | | | | | | |
| V | 4804.00 | 53.21 | 30.55 | 5.77 | 24.66 | 53.09 | 74.00 | -20.91 | Pk |
| V | 4804.00 | 43.70 | 30.55 | 5.77 | 24.66 | 43.58 | 54.00 | -10.42 | AV |
| V | 7206.00 | 53.87 | 30.33 | 6.32 | 24.55 | 54.41 | 74.00 | -19.59 | Pk |
| V | 7206.00 | 43.21 | 30.33 | 6.32 | 24.55 | 43.75 | 54.00 | -10.25 | AV |
| V | 9608.00 | 53.86 | 30.85 | 7.45 | 24.69 | 55.15 | 74.00 | -18.85 | Pk |
| V | 9608.00 | 43.56 | 30.85 | 7.45 | 24.69 | 44.85 | 54.00 | -9.15 | AV |
| V | 12010.00 | 54.77 | 31.02 | 8.99 | 25.57 | 58.31 | 74.00 | -15.69 | Pk |
| V | 12010.00 | 43.58 | 31.02 | 8.99 | 25.57 | 47.12 | 54.00 | -6.88 | AV |
| H | 4804.00 | 51.32 | 30.55 | 5.77 | 24.66 | 51.20 | 74.00 | -22.80 | Pk |
| H | 4804.00 | 43.27 | 30.55 | 5.77 | 24.66 | 43.15 | 54.00 | -10.85 | AV |
| H | 7206.00 | 50.52 | 30.33 | 6.32 | 24.55 | 51.06 | 74.00 | -22.94 | Pk |
| H | 7206.00 | 43.89 | 30.33 | 6.32 | 24.55 | 44.43 | 54.00 | -9.57 | AV |
| H | 9608.00 | 52.59 | 30.85 | 7.45 | 24.69 | 53.88 | 74.00 | -20.12 | Pk |
| H | 9608.00 | 43.52 | 30.85 | 7.45 | 24.69 | 44.81 | 54.00 | -9.19 | AV |
| H | 12010.00 | 50.38 | 31.02 | 8.99 | 25.57 | 53.92 | 74.00 | -20.08 | Pk |
| H | 12010.00 | 43.88 | 31.02 | 8.99 | 25.57 | 47.42 | 54.00 | -6.58 | AV |

| Polar (H/V) | Frequency | Meter Reading | Pre-amplifier | Cable Loss | Antenna Factor | Emission Level | Limits | Margin | Detector Type |
|------------------------|-----------|---------------|---------------|------------|----------------|----------------|----------|--------|---------------|
| | (MHz) | (dBuV) | (dB) | (dB) | (dB) | (dBuV/m) | (dBuV/m) | (dB) | |
| Middle Channel:2440MHz | | | | | | | | | |
| V | 4880.00 | 52.28 | 30.55 | 5.77 | 24.66 | 52.16 | 74.00 | -21.84 | Pk |
| V | 4880.00 | 43.11 | 30.55 | 5.77 | 24.66 | 42.99 | 54.00 | -11.01 | AV |
| V | 7320.00 | 52.09 | 30.33 | 6.32 | 24.55 | 52.63 | 74.00 | -21.37 | Pk |
| V | 7320.00 | 43.07 | 30.33 | 6.32 | 24.55 | 43.61 | 54.00 | -10.39 | AV |
| V | 9760.00 | 53.97 | 30.85 | 7.45 | 24.69 | 55.26 | 74.00 | -18.74 | Pk |
| V | 9760.00 | 43.99 | 30.85 | 7.45 | 24.69 | 45.28 | 54.00 | -8.72 | AV |
| V | 12200.00 | 51.43 | 31.02 | 8.99 | 25.57 | 54.97 | 74.00 | -19.03 | Pk |
| V | 12200.00 | 43.36 | 31.02 | 8.99 | 25.57 | 46.90 | 54.00 | -7.10 | AV |
| H | 4880.00 | 50.19 | 30.55 | 5.77 | 24.66 | 50.07 | 74.00 | -23.93 | Pk |
| H | 4880.00 | 43.10 | 30.55 | 5.77 | 24.66 | 42.98 | 54.00 | -11.02 | AV |
| H | 7320.00 | 53.45 | 30.33 | 6.32 | 24.55 | 53.99 | 74.00 | -20.01 | Pk |
| H | 7320.00 | 43.76 | 30.33 | 6.32 | 24.55 | 44.30 | 54.00 | -9.70 | AV |
| H | 9760.00 | 53.12 | 30.85 | 7.45 | 24.69 | 54.41 | 74.00 | -19.59 | Pk |
| H | 9760.00 | 43.92 | 30.85 | 7.45 | 24.69 | 45.21 | 54.00 | -8.79 | AV |
| H | 12200.00 | 51.25 | 31.02 | 8.99 | 25.57 | 54.79 | 74.00 | -19.21 | Pk |
| H | 12200.00 | 43.79 | 31.02 | 8.99 | 25.57 | 47.33 | 54.00 | -6.67 | AV |



| Polar (H/V) | Frequency | Meter Reading | Pre-amplifier | Cable Loss | Antenna Factor | Emission Level | Limits | Margin | Detector Type |
|----------------------|-----------|---------------|---------------|------------|----------------|----------------|----------|--------|---------------|
| | (MHz) | (dBuV) | (dB) | (dB) | (dB) | (dBuV/m) | (dBuV/m) | (dB) | |
| High Channel:2480MHz | | | | | | | | | |
| V | 4960.00 | 51.86 | 30.55 | 5.77 | 24.66 | 51.74 | 74.00 | -22.26 | Pk |
| V | 4960.00 | 43.43 | 30.55 | 5.77 | 24.66 | 43.31 | 54.00 | -10.69 | AV |
| V | 7440.00 | 50.36 | 30.33 | 6.32 | 24.55 | 50.90 | 74.00 | -23.10 | Pk |
| V | 7440.00 | 43.96 | 30.33 | 6.32 | 24.55 | 44.50 | 54.00 | -9.50 | AV |
| V | 9920.00 | 54.29 | 30.85 | 7.45 | 24.69 | 55.58 | 74.00 | -18.42 | Pk |
| V | 9920.00 | 43.82 | 30.85 | 7.45 | 24.69 | 45.11 | 54.00 | -8.89 | AV |
| V | 12400.00 | 52.03 | 31.02 | 8.99 | 25.57 | 55.57 | 74.00 | -18.43 | Pk |
| V | 12400.00 | 43.32 | 31.02 | 8.99 | 25.57 | 46.86 | 54.00 | -7.14 | AV |
| H | 4960.00 | 54.40 | 30.55 | 5.77 | 24.66 | 54.28 | 74.00 | -19.72 | Pk |
| H | 4960.00 | 43.47 | 30.55 | 5.77 | 24.66 | 43.35 | 54.00 | -10.65 | AV |
| H | 7440.00 | 51.87 | 30.33 | 6.32 | 24.55 | 52.41 | 74.00 | -21.59 | Pk |
| H | 7440.00 | 43.71 | 30.33 | 6.32 | 24.55 | 44.25 | 54.00 | -9.75 | AV |
| H | 9920.00 | 53.06 | 30.85 | 7.45 | 24.69 | 54.35 | 74.00 | -19.65 | Pk |
| H | 9920.00 | 43.69 | 30.85 | 7.45 | 24.69 | 44.98 | 54.00 | -9.02 | AV |
| H | 12400.00 | 50.58 | 31.02 | 8.99 | 25.57 | 54.12 | 74.00 | -19.88 | Pk |
| H | 12400.00 | 43.92 | 31.02 | 8.99 | 25.57 | 47.46 | 54.00 | -6.54 | AV |

Remark:

1. Emission Level = Meter Reading + Antenna Factor + Cable Loss – Pre-amplifier, Margin= Emission Level - Limit
2. If peak below the average limit, the average emission was no test.
3. The amplitude of spurious emissions which are attenuated by more than 20dB below the permissible value has no need to be reported.



5. RADIATED BAND EMISSION MEASUREMENT

5.1 TEST REQUIREMENT:

| | | | | | |
|-----------------------|--|----------|------|------|---------|
| Test Requirement: | FCC Part15 C Section 15.209 and 15.205 | | | | |
| Test Method: | ANSI C63.10: 2013 | | | | |
| Test Frequency Range: | All of the restrict bands were tested, only the worst band's (2310MHz to 2500MHz) data was showed. | | | | |
| Test site: | Measurement Distance: 3m | | | | |
| Receiver setup: | Frequency | Detector | RBW | VBW | Value |
| | Above | Peak | 1MHz | 3MHz | Peak |
| | 1GHz | Average | 1MHz | 3MHz | Average |

LIMITS OF RADIATED EMISSION MEASUREMENT (Above 1000MHz)

| FREQUENCY (MHz) | Limit (dBuV/m) (at 3M) | |
|-----------------|------------------------|---------|
| | PEAK | AVERAGE |
| Above 1000 | 74 | 54 |

Notes:

- (1) The limit for radiated test was performed according to FCC PART 15C.
- (2) The tighter limit applies at the band edges.
- (3) Emission level (dBuV/m)=20log Emission level (uV/m).

5.2 TEST PROCEDURE

Above 1GHz test procedure as below:

- a. 1. The EUT was placed on the top of a rotating table 1.5 meters above the ground at a 3 meter camber. The table was rotated 360 degrees to determine the position of the highest radiation.
- b. The EUT was set 3 meters away from the interference-receiving antenna, which was mounted on the top of a variable-height antenna tower.
- c. The antenna height is varied from one meter to four meters above the ground to determine the maximum value of the field strength. Both horizontal and vertical polarizations of the antenna are set to make the measurement.
- d. For each suspected emission, the EUT was arranged to its worst case and then the antenna was tuned to heights from 1 meter to 4 meters and the rota table was turned from 0 degrees to 360 degrees to find the maximum reading.
- e. The test-receiver system was set to Peak Detect Function and Specified Bandwidth with Maximum Hold Mode.
- f. If the emission level of the EUT in peak mode was 10dB lower than the limit specified, then testing could be stopped and the peak values of the EUT would be reported. Otherwise the emissions that did not have 10dB margin would be re-tested one by one using peak, quasi-peak or average method as specified and then reported in a data sheet.
- g. Test the EUT in the lowest channel, the Highest channel

Note:

Both horizontal and vertical antenna polarities were tested and performed pretest to three orthogonal axis. The worst case emissions were reported

5.3 DEVIATION FROM TEST STANDARD

No deviation



5.4 TEST SETUP

Radiated Emission Test-Up Frequency Above 1GHz

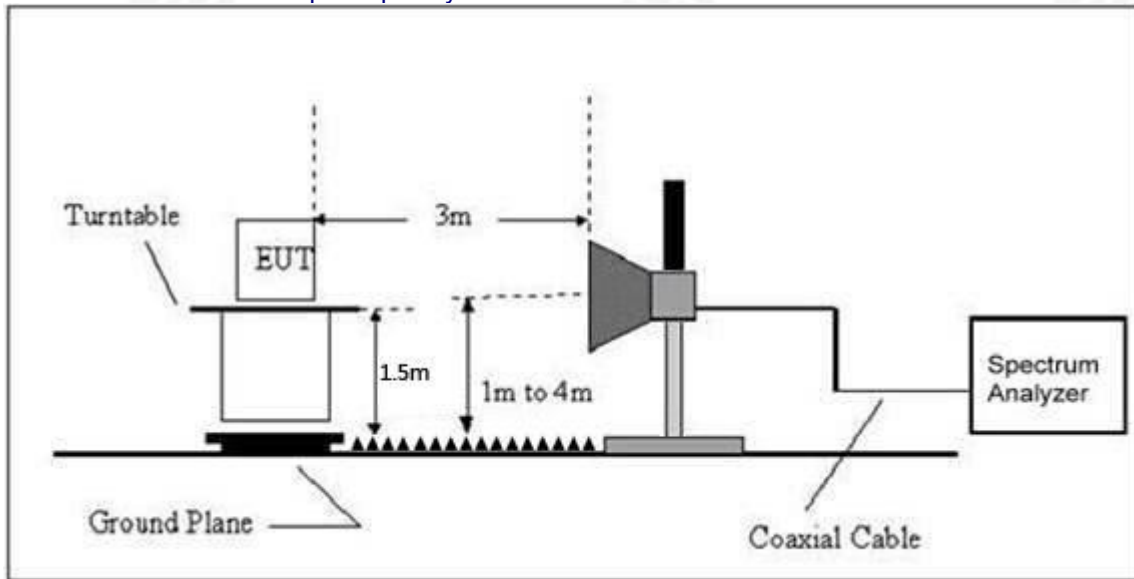

5.5 EUT OPERATING CONDITIONS

The EUT tested system was configured as the statements of 2.3 Unless otherwise a special operating condition is specified in the follows during the testing.



5.6 TEST RESULT

| | Polar (H/V) | Frequency (MHz) | Meter Reading (dBuV) | Pre-amplifier (dB) | Cable Loss (dB) | Antenna Factor (dB/m) | Emission level (dBuV/m) | Limit (dBuV/m) | Detector Type | Result |
|---|-----------------------|-----------------|----------------------|--------------------|-----------------|-----------------------|-------------------------|----------------|---------------|--------|
| GFSK | Low Channel: 2402MHz | | | | | | | | | |
| | H | 2390.00 | 54.58 | 30.22 | 4.85 | 23.98 | 53.19 | 74.00 | PK | PASS |
| | H | 2390.00 | 44.08 | 30.22 | 4.85 | 23.98 | 42.69 | 54.00 | AV | PASS |
| | H | 2400.00 | 53.49 | 30.22 | 4.85 | 23.98 | 52.10 | 74.00 | PK | PASS |
| | H | 2400.00 | 44.59 | 30.22 | 4.85 | 23.98 | 43.20 | 54.00 | AV | PASS |
| | V | 2390.00 | 54.19 | 30.22 | 4.85 | 23.98 | 52.80 | 74.00 | PK | PASS |
| | V | 2390.00 | 44.06 | 30.22 | 4.85 | 23.98 | 42.67 | 54.00 | AV | PASS |
| | V | 2400.00 | 53.62 | 30.22 | 4.85 | 23.98 | 52.23 | 74.00 | PK | PASS |
| | V | 2400.00 | 44.29 | 30.22 | 4.85 | 23.98 | 42.90 | 54.00 | AV | PASS |
| | High Channel: 2480MHz | | | | | | | | | |
| | H | 2483.50 | 54.78 | 30.22 | 4.85 | 23.98 | 53.39 | 74.00 | PK | PASS |
| | H | 2483.50 | 44.67 | 30.22 | 4.85 | 23.98 | 43.28 | 54.00 | AV | PASS |
| | H | 2500.00 | 53.45 | 30.22 | 4.85 | 23.98 | 52.06 | 74.00 | PK | PASS |
| | H | 2500.00 | 44.80 | 30.22 | 4.85 | 23.98 | 43.41 | 54.00 | AV | PASS |
| | V | 2483.50 | 54.73 | 30.22 | 4.85 | 23.98 | 53.34 | 74.00 | PK | PASS |
| | V | 2483.50 | 44.14 | 30.22 | 4.85 | 23.98 | 42.75 | 54.00 | AV | PASS |
| | V | 2500.00 | 53.36 | 30.22 | 4.85 | 23.98 | 51.97 | 74.00 | PK | PASS |
| | V | 2500.00 | 44.69 | 30.22 | 4.85 | 23.98 | 43.30 | 54.00 | AV | PASS |
| Remark: | | | | | | | | | | |
| 1. Emission Level = Meter Reading + Antenna Factor + Cable Loss – Pre-amplifier, Margin= Emission Level - Limit | | | | | | | | | | |



6. POWER SPECTRAL DENSITY TEST

| | |
|-------------------|--|
| Test Requirement: | FCC Part15 C Section 15.247 (e) |
| Test Method: | KDB558074 D0115.247 Meas Guidance v05r02 |

6.1 APPLIED PROCEDURES / LIMIT

| FCC Part15 (15.247) , Subpart C | | | | |
|---------------------------------|------------------------|-----------|-----------------------|--------|
| Section | Test Item | Limit | Frequency Range (MHz) | Result |
| 15.247 | Power Spectral Density | 8dBm/3kHz | 2400-2483.5 | PASS |

6.2 TEST PROCEDURE

1. Set analyzer center frequency to DTS channel center frequency.
2. Set the span to 1.5 times the DTS bandwidth.
3. Set the RBW to: $3 \text{ kHz} \leq \text{RBW} \leq 100 \text{ kHz}$.
4. Set the VBW $\geq 3 \times \text{RBW}$.
5. Detector = peak.
6. Sweep time = auto couple.
7. Trace mode = max hold.
8. Allow trace to fully stabilize.
9. Use the peak marker function to determine the maximum amplitude level within the RBW.
10. If measured value exceeds limit, reduce RBW (no less than 3 kHz) and repeat.

6.3 DEVIATION FROM STANDARD

No deviation.

6.4 TEST SETUP



6.5 EUT OPERATION CONDITIONS

The EUT tested system was configured as the statements of 2.1 Unless otherwise a special operating condition is specified in the follows during the testing.



6.6 TEST RESULT

| | | | |
|---------------|------|---------------------|--------|
| Temperature : | 26°C | Relative Humidity : | 54% |
| Test Mode : | GFSK | Test Voltage : | DC 24V |

| Frequency | Power Spectral Density (dBm/3kHz) | Limit (dBm/3kHz) | Result |
|-----------|-----------------------------------|------------------|--------|
| 2402 MHz | -16.643 | 8 | PASS |
| 2440 MHz | -17.205 | 8 | PASS |
| 2480 MHz | -18.083 | 8 | PASS |

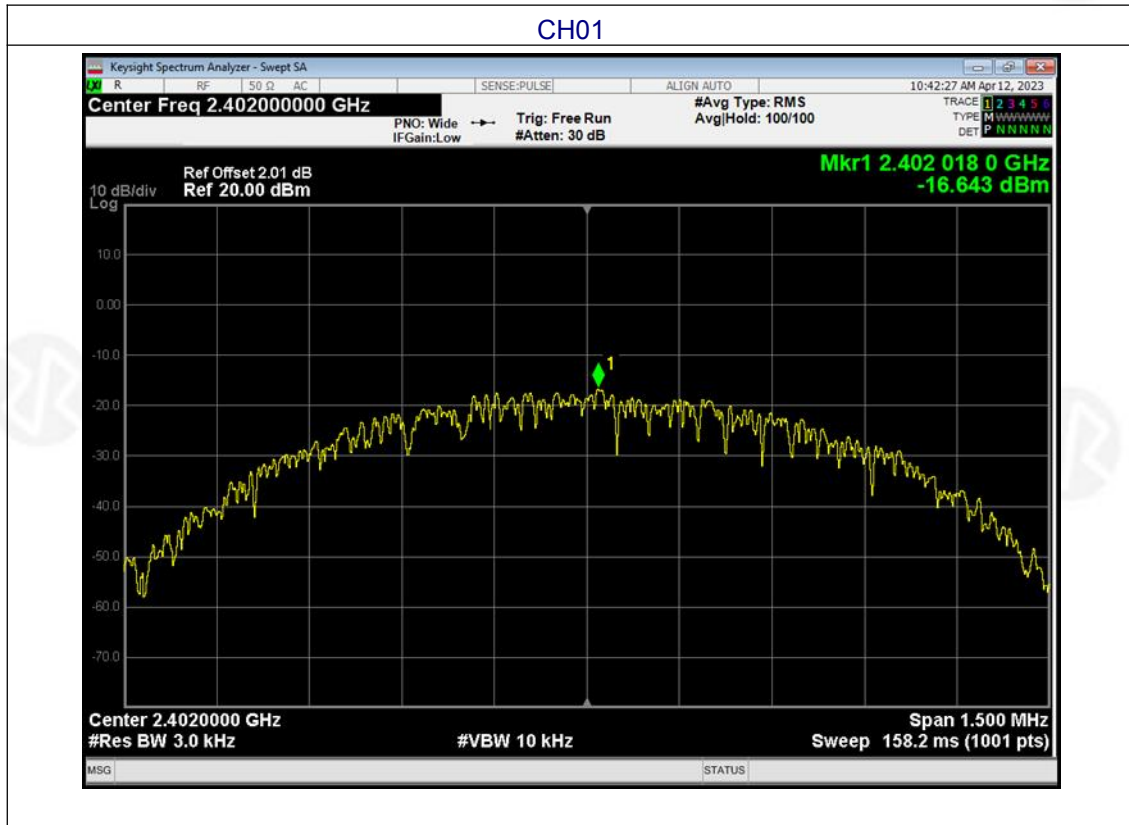



CH20

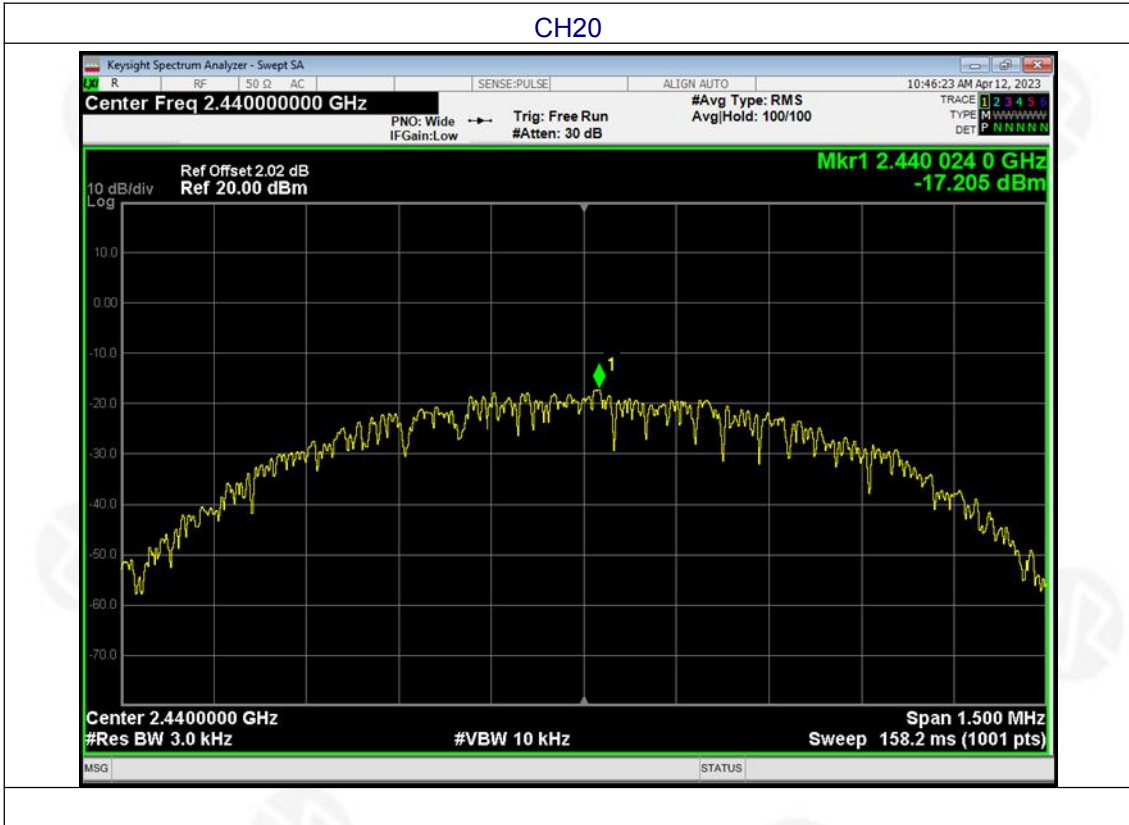

CH40

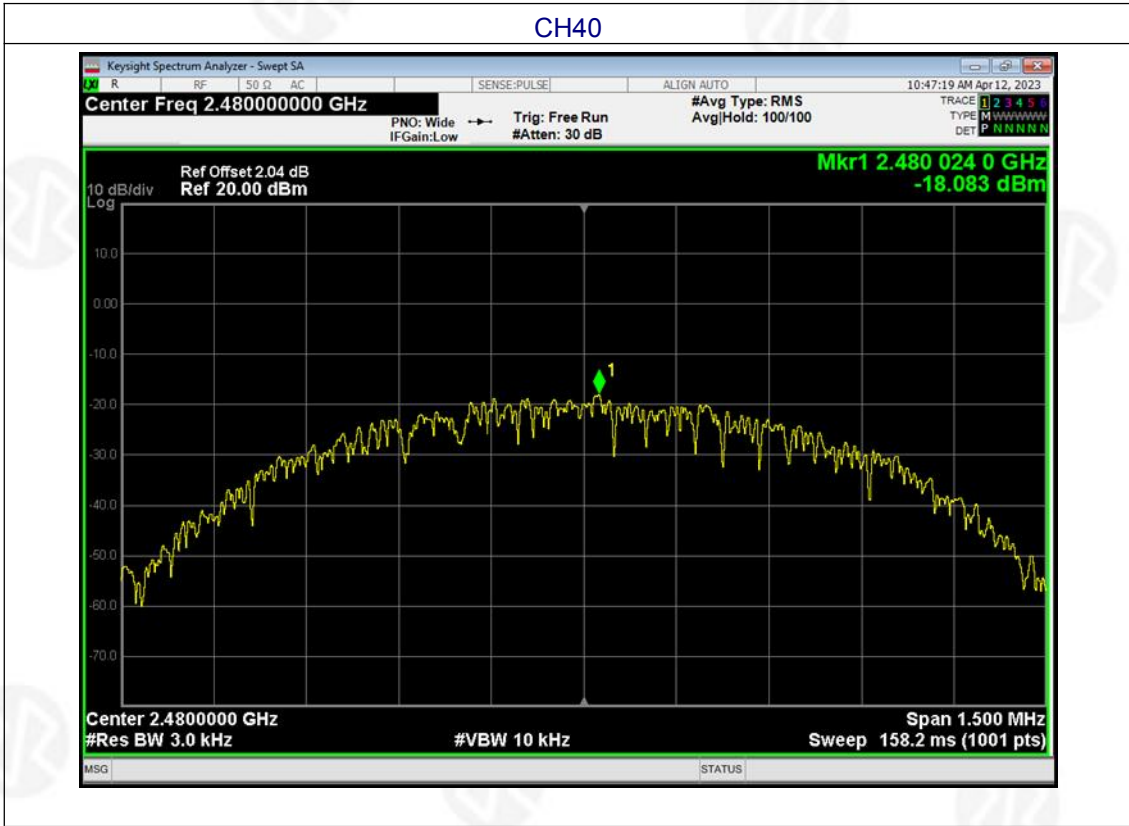



7. CHANNEL BANDWIDTH

| | |
|-------------------|--|
| Test Requirement: | FCC Part15 C Section 15.247 (a)(2) |
| Test Method: | KDB558074 D0115.247 Meas Guidance v05r02 |

7.1 APPLIED PROCEDURES / LIMIT

| FCC Part15 (15.247) , Subpart C | | | | |
|---------------------------------|-----------|--|-----------------------|--------|
| Section | Test Item | Limit | Frequency Range (MHz) | Result |
| 15.247(a)(2) | Bandwidth | $\geq 500\text{KHz}$ (-6dB bandwidth) | 2400-2483.5 | PASS |

7.2 TEST PROCEDURE

1. Set RBW = 100 kHz.
2. Set the video bandwidth (VBW) $\geq 3 \times$ RBW.
3. Detector = Peak.
4. Trace mode = max hold.
5. Sweep = auto couple.
6. Allow the trace to stabilize.
7. Measure the maximum width of the emission that is constrained by the frequencies associated with the two outermost amplitude points (upper and lower frequencies) that are attenuated by 6 dB relative to the maximum level measured in the fundamental emission.

7.3 DEVIATION FROM STANDARD

No deviation.

7.4 TEST SETUP

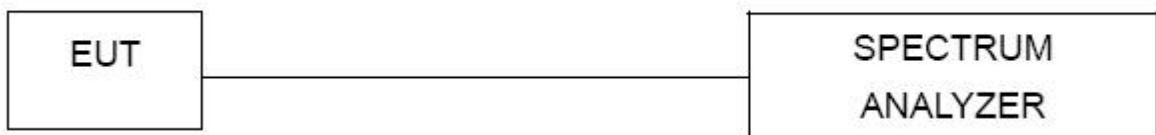

7.5 EUT OPERATION CONDITIONS

The EUT tested system was configured as the statements of 2.4 Unless otherwise a special operating condition is specified in the follows during the testing.



7.6 TEST RESULT

| | | | |
|---------------|------|---------------------|--------|
| Temperature : | 26°C | Relative Humidity : | 54% |
| Test Mode : | GFSK | Test Voltage : | DC 24V |

| Test channel | Channel Bandwidth (MHz) | Limit(KHz) | Result |
|--------------|-------------------------|------------|--------|
| Lowest | 0.7246 | >500 | Pass |
| Middle | 0.7358 | | |
| Highest | 0.7019 | | |

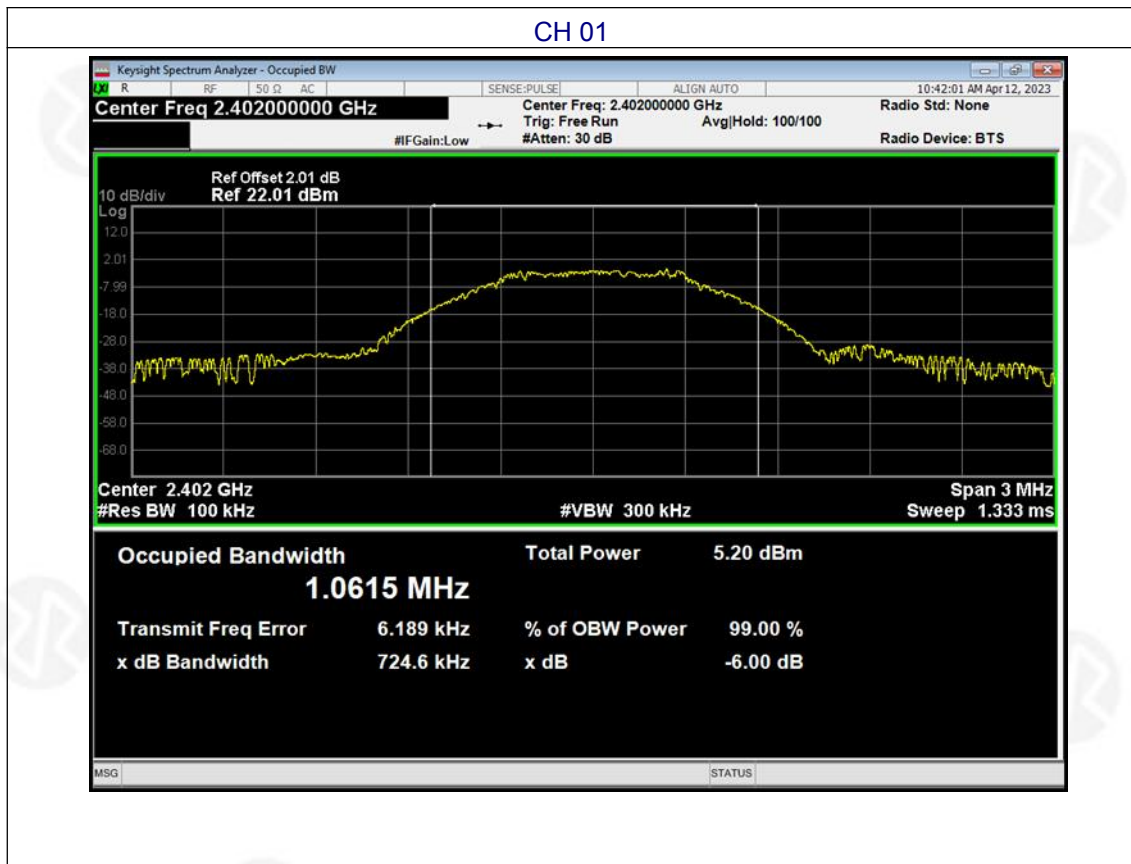



CH20

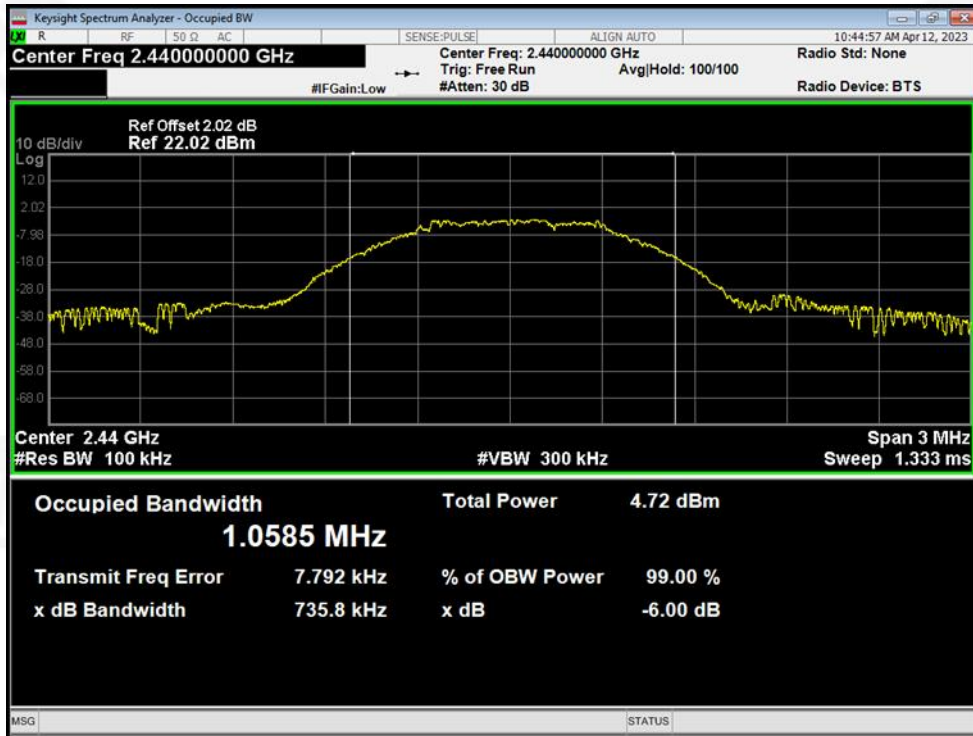

CH40





8. PEAK OUTPUT POWER TEST

| | |
|-------------------|--|
| Test Requirement: | FCC Part15 C Section 15.247 (b)(3) |
| Test Method: | KDB558074 D0115.247 Meas Guidance v05r02 |

8.1 APPLIED PROCEDURES / LIMIT

| FCC Part15 (15.247) , Subpart C | | | | |
|---------------------------------|-------------------|-----------------|-----------------------|--------|
| Section | Test Item | Limit | Frequency Range (MHz) | Result |
| 15.247(b)(3) | Peak Output Power | 1 watt or 30dBm | 2400-2483.5 | PASS |

8.2 TEST PROCEDURE

- a. The EUT was directly connected to the Power meter

8.3 DEVIATION FROM STANDARD

No deviation.

8.4 TEST SETUP



8.5 EUT OPERATION CONDITIONS

The EUT tested system was configured as the statements of 2.4 Unless otherwise a special operating condition is specified in the follows during the testing.

8.6 TEST RESULT

| | | | |
|---------------|------|---------------------|--------|
| Temperature : | 26°C | Relative Humidity : | 54% |
| Test Mode : | GFSK | Test Voltage : | DC 24V |

| Test channel | Peak Output Power (dBm) | Limit(dBm) | Result |
|--------------|-------------------------|------------|--------|
| Lowest | -0.709 | 30.00 | Pass |
| Middle | -1.598 | | |
| Highest | -0.172 | | |



9. CONDUCTED BAND EDGE AND SPURIOUS EMISSION

| | |
|-------------------|--|
| Test Requirement: | FCC Part15 C Section 15.247 (d) |
| Test Method: | KDB558074 D0115.247 Meas Guidance v05r02 |

9.1 APPLICABLE STANDARD

In any 100 kHz bandwidth outside the frequency band in which the spread spectrum intentional radiator is operating, the radio frequency power that is produced by the intentional radiator shall be at least 20 dB below that in the 100 kHz bandwidth within the band that contains the highest level of the desired power, based on either an RF conducted or a radiated measurement.

9.2 TEST PROCEDURE

Using the following spectrum analyzer setting:

- A) Set the RBW = 100KHz.
- B) Set the VBW = 300KHz.
- C) Sweep time = auto couple.
- D) Detector function = peak.
- E) Trace mode = max hold.
- F) Allow trace to fully stabilize.

9.3 DEVIATION FROM STANDARD

No deviation.

9.4 TEST SETUP

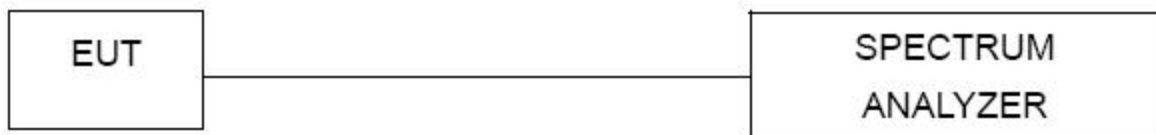

9.5 EUT OPERATION CONDITIONS

The EUT tested system was configured as the statements of 2.4 Unless otherwise a special operating condition is specified in the follows during the testing.

9.6 TEST RESULTS



GFSK: Band Edge, Left Side

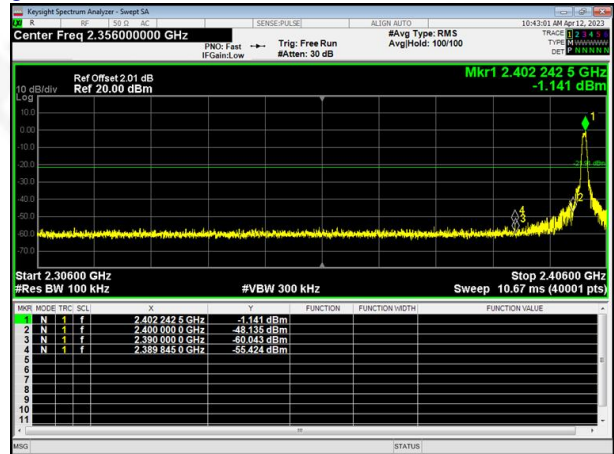
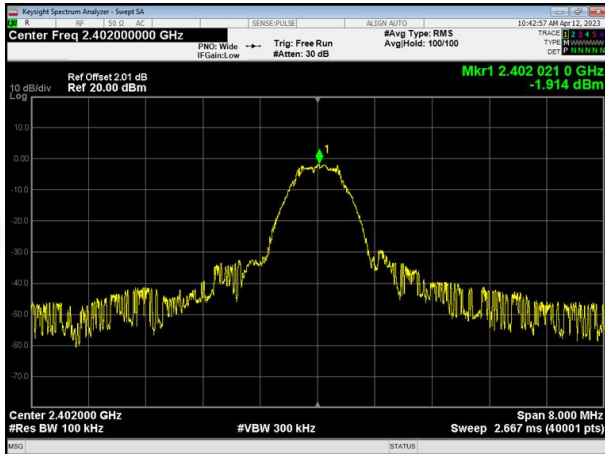

GFSK: Band Edge, Right Side

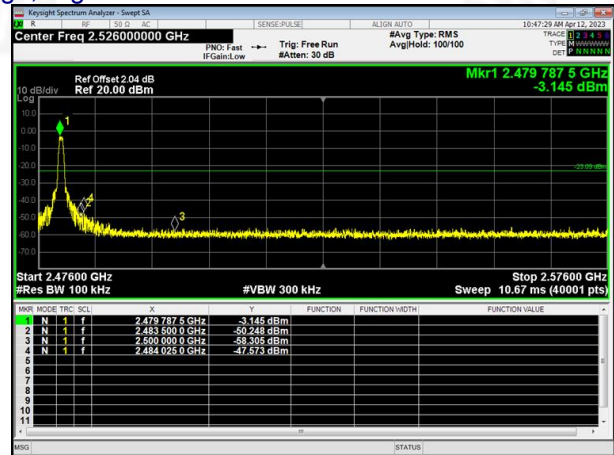
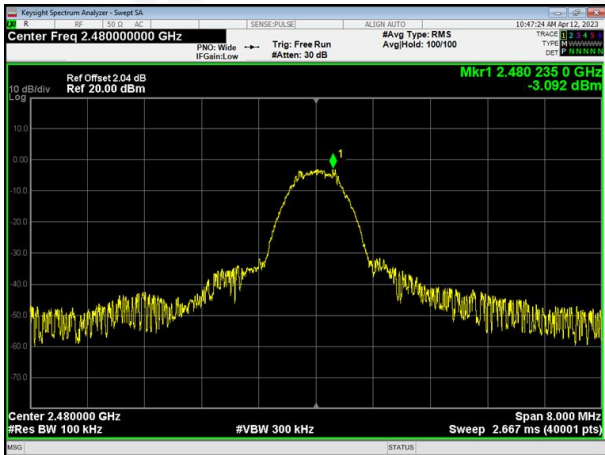



Lowest channel

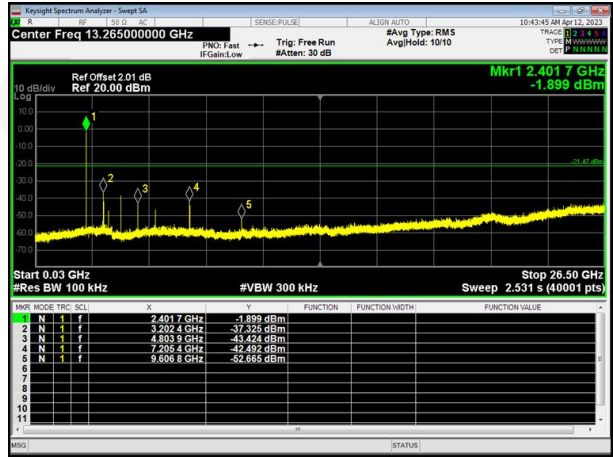

Middle channel

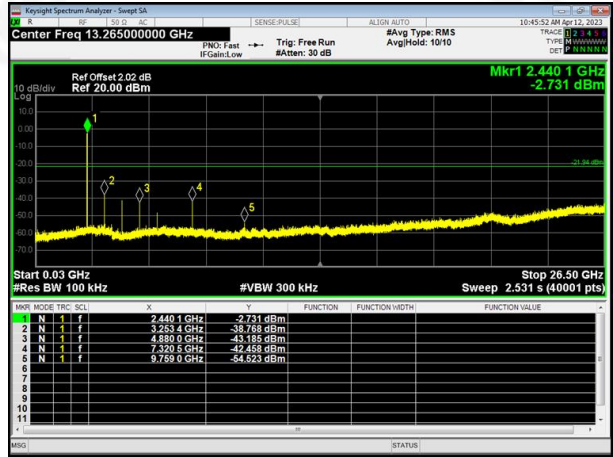

Highest channel

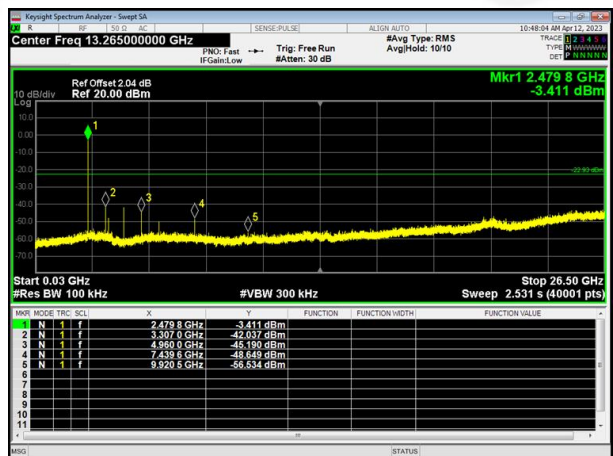
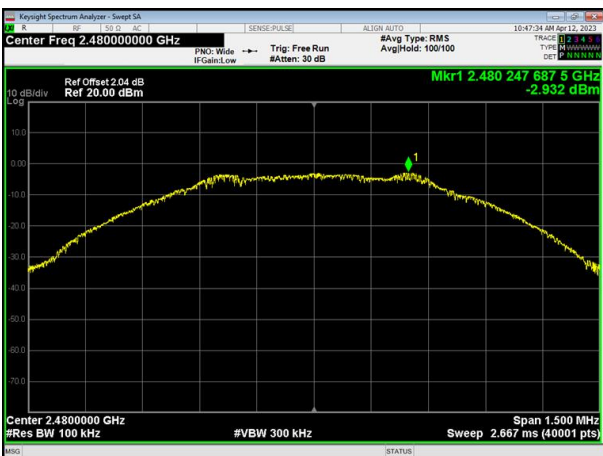



10.ANTENNA REQUIREMENT

| | |
|---|-------------------------------------|
| Standard requirement: | FCC Part15 C Section 15.203 /247(c) |
| 15.203 requirement: An intentional radiator shall be designed to ensure that no antenna other than that furnished by the responsible party shall be used with the device. The use of a permanently attached antenna or of an antenna that uses a unique coupling to the intentional radiator, the manufacturer may design the unit so that a broken antenna can be replaced by the user, but the use of a standard antenna jack or electrical connector is prohibited. | |
| 15.247(c) (1)(i) requirement: (i) Systems operating in the 2400-2483.5 MHz band that is used exclusively for fixed. Point-to-point operations may employ transmitting antennas with directional gain greater than 6dBi provided the maximum conducted output power of the intentional radiator is reduced by 1 dB for every 3 dB that the directional gain of the antenna exceeds 6dBi. | |
| EUT Antenna: | |
| The antenna is PCB Antenna, the best case gain of the antennas is 3.3dBi, reference to the appendix II for details | |



11. TEST SETUP PHOTO

Reference to the appendix I for details.

12. EUT CONSTRUCTIONAL DETAILS

Reference to the appendix II for details.

***** END OF REPORT *****