



## FCC TEST REPORT

**FCC ID: 2A8JV-IPDA099**

On Behalf of

Guangzhou Munbyn Information Technology Co., Ltd.

Android Barcode Scanner

Model No.: IPDA099, IPDA061, MC01, MC02, MC03, MC04, MC05

Prepared for : Guangzhou Munbyn Information Technology Co., Ltd.  
Address : Unit L3A01-4, No. 31-6, Xicha Road, Baiyun District, Guangzhou

Prepared By : Shenzhen PSI Testing Co., Ltd.  
1-2/F., Building 5, Yudafu Industrial Park, No.10, Xingye West  
Address : Road, Shajing Subdistrict, Bao'an District, Shenzhen, Guangdong,  
China

Report Number : psi2407047-C01-R01  
Date of Receipt : July 3, 2024  
Date of Test : July 3, 2024-July 18, 2024  
Date of Report : July 18, 2024  
Version Number : V0

## TABLE OF CONTENTS

Description	Page
<b>1 TEST SUMMARY .....</b>	<b>5</b>
<b>2 GENERAL INFORMATION .....</b>	<b>6</b>
2.1 GENERAL DESCRIPTION OF EUT .....	6
2.2 RELATED SUBMITTAL(S) / GRANT (S) .....	8
2.3 TEST METHODOLOGY .....	8
2.4 TEST FACILITY .....	8
2.5 ACCESSORIES OF DEVICE (EUT) .....	8
2.6 TESTED SUPPORTING SYSTEM DETAILS .....	8
2.7 TEST CONDITIONS .....	8
2.8 MEASUREMENT UNCERTAINTY .....	9
<b>3 TEST INSTRUMENTS LIST .....</b>	<b>10</b>
<b>4 SYSTEM TEST CONFIGURATION .....</b>	<b>11</b>
4.1 TEST MODE .....	11
4.2 CONFIGURATION OF TESTED SYSTEM .....	11
4.3 TRANSMITTER RADIATED POWER (EIRP/ERP) .....	12
4.4 PEAK-TO-AVERAGE RATIO .....	14
4.5 OCCUPY BANDWIDTH .....	15
4.6 MODULATION CHARACTERISTIC .....	16
4.7 OUT OF BAND EMISSION AT ANTENNA TERMINALS .....	16
4.8 FIELD STRENGTH OF SPURIOUS RADIATION MEASUREMENT .....	17
4.9 FREQUENCY STABILITY MEASUREMENT .....	25
4.10 PHOTOS OF TEST SETUP .....	26

### TEST REPORT DECLARATION

Applicant : Guangzhou Munbyn Information Technology Co., Ltd.  
 Address : Unit L3A01-4, No. 31-6, Xicha Road, Baiyun District, Guangzhou  
 Manufacturer : Guangzhou Munbyn Information Technology Co., Ltd.  
 Address : Unit L3A01-4, No. 31-6, Xicha Road, Baiyun District, Guangzhou  
 EUT Description : Android Barcode Scanner  
 (A) Model No. : IPDA099, IPDA061, MC01, MC02, MC03, MC04, MC05  
 (B) Trademark : NAXA, HENA

Measurement Standard Used:

**FCC CFR Title 47 Part 2**  
**FCC CFR Title 47 Part 22 Subpart H**  
**FCC CFR Title 47 Part 24 Subpart E**

The device described above is tested by Shenzhen PSI Testing Co., Ltd. to determine the maximum emission levels emanating from the device. The maximum emission levels are compared to the FCC Part 15 Subpart C limits both conducted and radiated emissions. The test results are contained in this test report and Shenzhen PSI Testing Co., Ltd. is assumed of full responsibility for the accuracy and completeness of these tests.

After the test, our opinion is that EUT compliance with the requirement of the above standards.

This report applies to above tested sample only. This report shall not be reproduced in parts without written approval of Shenzhen PSI Testing Co., Ltd.

Tested by (name + signature).....: Felix Pang *Felix Pang*  
 Test Engineer .....

Approved by (name + signature).....: Simple Guan *Simple Guan*  
 Project Manager .....

Date of issue.....: July 18, 2024

**Revision History**

Revision	Issue Date	Revisions	Revised By
V0	July 18, 2024	Initial released Issue	Felix Pang



## 1 Test Summary

Test Item	Section in CFR 47	Result
RF Exposure (SAR)	Part 1.1307 Part 2.1093	Pass* (Please refer to SAR Report)
Transmitter Radiated Power (EIRP/ERP)	Part 2.1046 Part 22.913 (a)(2) Part 24.232 (c)	Pass
Peak-to-Average Ratio	Part 2.1046 Part 24.232 (d)	Pass
Modulation Characteristics	Part 2.1047	Pass
99% & -26 dB Occupied Bandwidth	Part 2.1049	Pass
Spurious Emissions at Antenna Terminal	Part 2.1051 Part 22.917 (a) Part 24.238 (a)	Pass
Field Strength of Spurious Radiation	Part 2.1053 Part 22.917 (a) Part 24.238 (a)	Pass
Frequency stability	Part 2.1055(a)(1)(b) Part 2.1055(d)(1)(2)	Pass

*Pass: The EUT complies with the essential requirements in the standard.*

## 2 General Information

### 2.1 General Description of EUT

Description/PMN	: Android Barcode Scanner
Model Number/HVIN(s)	: IPDA099, IPDA061, MC01, MC02, MC03, MC04, MC05 All models are same with electrical parameters and internal circuit structure,
Diff	: but only differ model name (this information provided by the customer). All tests are made with the IPDA099 model.
Test Voltage	: DC 5V from adapter, DC 3.8V from battery
Support Networks	: GSM, GPRS, EGPRS
Support Bands	: GSM 850, PCS 1900
TX Frequency	: GSM 850: 824.20MHz-848.80MHz PCS 1900: 1850.20MHz-1909.80MHz
GPRS Class	: 12
EGPRS Class	: 12
Modulation type	: GPRS: GMSK EGPRS: 8PSK
Antenna type	: FPC Antenna
Antenna gain	: Maximum Gain is -6.1dBi for GSM 850 Maximum Gain is 0.6dBi for PCS1900
Software version	: 20221206.185812
Hardware version	: V1.0.

- Remark: 1. The worst-case simultaneous transmission configuration was evaluated with no non-compliance found. Results in this report are only for 2G function, and there is no other transmitter involved.
2. The product has two antennas, one of which is a diversity antenna with only receiving function.
3. The product contains two SIM card slots, both of which have been tested and only reflect the data of SIM card slot 1.

**Operation Frequency List:**

GSM 850		PCS1900	
Channel	Frequency (MHz)	Channel	Frequency (MHz)
128	824.20	512	1850.20
129	824.40	513	1850.40
· ∴	· ∴	· ∴	· ∴
189	836.40	660	1879.80
190	836.60	661	1880.00
191	836.80	662	1880.20
· ∴	· ∴	· ∴	· ∴
250	848.60	809	1909.60
251	848.80	810	1909.80

Regards to the operating frequency range over 10 MHz, the Lowest frequency, the middle frequency, and the highest frequency of channel were selected to perform the test, and the selected channel see below:

**Final test channel:**

GSM 850		PCS1900	
Channel	Frequency (MHz)	Channel	Frequency (MHz)
128	824.20	512	1850.20
190	836.60	661	1880.00
251	848.80	810	1909.80

## 2.2 Related Submittal(s) / Grant (s)

This submittal(s) (test report) is filing to comply with Section Part 22 subpart H and Part 24 subpart E of the FCC CFR 47 Rules.

## 2.3 Test Methodology

Both conducted and radiated testing were performed according to the procedures document on TIA/EIA 603 and FCC CFR 47.1046, 2.1047, 2.1049, 2.1051, 2.1053, 2.1055 and 2.1057

## 2.4 Test Facility

Shenzhen PSI Testing Co., Ltd.  
1-2/F., Building 5, Yudafu Industrial Park, No.10, Xingye West Road, Shajing Subdistrict, Bao'an District, Shenzhen, Guangdong, China

September 21, 2023 File on Federal Communication Commission  
Registration Number: 916281

September 21, 2023 Certificated by IC  
Registration Number: 31123  
CAB identifier: CN0158

## 2.5 Accessories of Device (EUT)

Accessories : N/A  
Manufacturer : N/A  
Model : N/A  
Ratings : N/A

## 2.6 Tested Supporting System Details

No.	Description	Manufacturer	Model	Serial Number	Certification
1.	N/A	N/A	N/A	N/A	N/A

## 2.7 Test Conditions

Items	Required
Temperature range:	15-35°C
Humidity range:	25-75%
Pressure range:	86-106kPa



## 2.8 Measurement Uncertainty

(95% confidence levels, k=2)

Item	Uncertainty
Uncertainty for Power Line Conducted Emissions Test	2.17dB
Uncertainty for Radiation Emission test in 3m chamber (below 30MHz)	3.5dB
Uncertainty for Radiation Emission test in 3m chamber (30MHz to 1GHz)	2.74dB(Polarize: V)
	2.76dB(Polarize: H)
Uncertainty for Radiation Emission test in 3m chamber (1GHz to 18GHz)	4.29dB(Polarize: V)
	4.82dB(Polarize: H)
Uncertainty for Radiation Emission test in 3m chamber (18GHz to 40GHz)	4.31dB(Polarize: V)
	4.30dB(Polarize: H)
Uncertainty for radio frequency	48.24KHz
Uncertainty for conducted RF Power	0.41dB
Uncertainty for Power Spectral Density	0.39 dB
Occupied-Bandwidth	968Hz
Conducted-Spurious Emission	1.26dB

### 3 Test Instruments list

Item	Equipment	Manufacturer	Model No.	Serial No.	Firmware Version	Last Cal.	Cal. Interval
1.	9*6*6 anechoic chamber	SKET	9*6*6	N/A	/	2022.12.20	3 Year
2.	Test Receiver	Rohde&Schwarz	ESCI 7	101032/003	4.42 SP3	2023.12.19	1 Year
3.	L.I.S.N.#1	Rohde&Schwarz	ENV216	102282	/	2023.12.19	1 Year
4.	L.I.S.N.#2	RFT	NNB111	13835240	/	2023.12.19	1 Year
5.	Loop Antenna	Schwarz beck	FMZB 1519B	00128	/	2023.04.03	2 Year
6.	Bilog Antenna	Schwarz beck	VULB 9168	01448	/	2022.12.26	2 Year
7.	Spectrum Analyzer	Rohde&Schwarz	FSV-40N	101648	3.70	2023.12.19	1 Year
8.	Horn Antenna	Schwarz beck	BBHA 9120 D	02706	/	2022.12.26	2 Year
9.	Amplifier	SKET	LAPA_01G1 8G-45dB	SK20220329 01	/	2023.12.19	1 Year
10.	Horn Antenna	Schwarz beck	BBHA 9170	00946	/	2022.12.25	2 Year
11.	Amplifier	SKET	LNPA_0118 G-45	SK20200108 01	/	2023.12.19	1 Year
12.	RF Power Probe	Rohde&Schwarz	NRP-Z11	1138.3004.02 -1111533-Fz	/	2023.12.19	1 Year
13.	RF Sensor Unit	Tachoy	TR1029-2	20220428P0 08	/	2023.12.19	1 Year
14.	Spectrum Analyzer	Agilent	N9020A	MY51281067	A.14.03	2023.12.19	1 Year
15.	Temp. & Humid Chamber	Auchno	9606	/	/	2023.12.19	1 Year
16.	Regulated DC Power Supply	Xinouhua	ADC120V10 A	20221125163 8		2023.12.19	1 Year

#### For Test Software Information

Item	Software Name	Manufacturer	Version
RE	EZ_EMCC	Farad	PSI-3A1
RF	RTS	TACHOY	V1.0.0

## 4 System test configuration

### 4.1 Test mode

During all testing, EUT is in link mode with base station emulator at maximum power level. The spurious emission measurements were carried out in semi-anechoic chamber with 3-meter test range, and EUT is rotated on three test planes to find out the worst emission.

Test modes		
Band	Radiated	Conducted
GSM 850	■ GSM link	■ GSM link
	■ GPRS 1 link	■ GPRS 1 link
	■ EPRS 1 link	■ EGPRS 1 link
PCS 1900	■ GSM link	■ GSM link
	■ GPRS 1 link	■ GPRS 1 link
	■ EGPRS 1 link	■ EGPRS 1 link

Note: The maximum power levels are GSM mode for GMSK link, GPRS multi-slot class 8 mode for GMSK link, EGPRS multi-slot class 8 mode for 8PSK link.

### 4.2 Configuration of Tested System

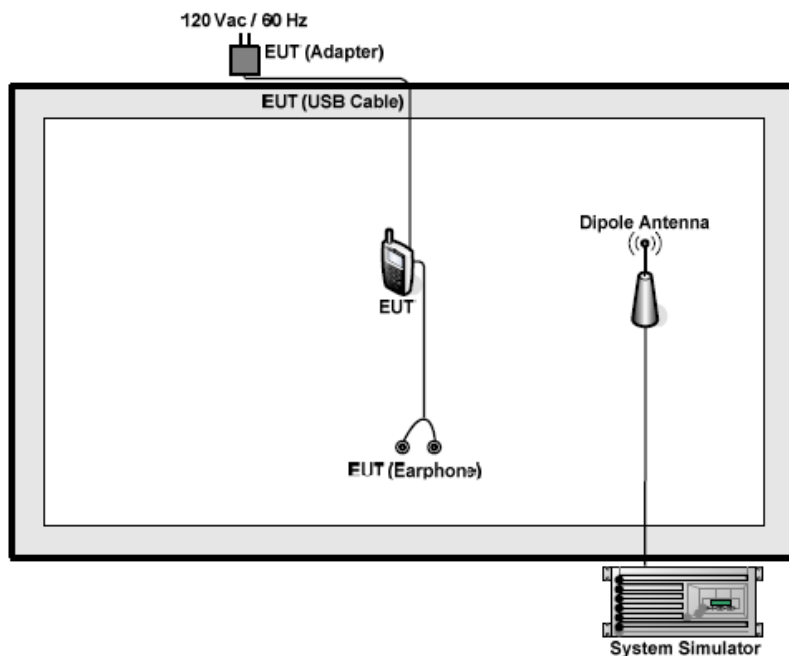

### 4.3 Transmitter Radiated Power (EIRP/ERP)

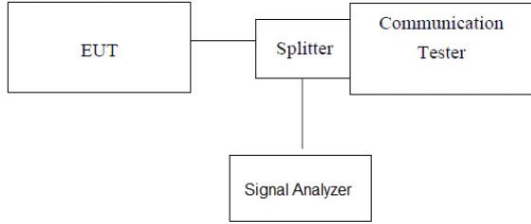
Test Requirement:	FCC part22.913(a) and FCC part24.232(b), FCC part 27.50 (d)(4)
Test Method:	FCC part2.1046
Limit:	GSM850, 7W PCS1900, 2W
Test setup:	 <p style="text-align: center;"><i>Note: Measurement setup for testing on Antenna connector</i></p>
Test Procedure:	<p><b>Description of the Conducted Output Power Measurement</b></p> <p>The EUT is coupled to the SS with attenuator through power splitter; the RF load attached to EUT antenna terminal is 50Ohm; the path loss as the factor is calibrated to correct the reading. A system simulator is used to establish communication with the EUT, and its parameters are set to force the EUT transmitting at maximum output power. The measured power in the radio frequency on the transmitter output terminals shall be reported.</p> <p>The relevant equation for determining the conducted measured value is:  Conducted Output Power Value (dBm) = Measured Value (dBm) + Path Loss (dB)</p> <p>where:  Conducted Output Power Value = final conducted measured value in the conducted power test, in dBm; Measured Value = measured conducted power received by spectrum analyzer or power meter, in dBm;  Path Loss = signal attenuation in the connecting cable between the transmitter and spectrum analyzer or power meter, including external cable loss, in dB;</p> <p>During the test, the data of Path Loss (dB) is added in the spectrum analyzer or power meter, so Measured Value (dBm) is the final values which contains the data of Path Loss (dB).</p> <p>For example:  In the conducted output power test, when measured value for GSM850 is 24.7 dBm, and path loss is 8.5 dB, then final conducted output power value is:  Conducted Output Power Value (dBm) = 24.7 dBm + 8.5 dB = 33.2 dBm</p> <p><b>Description of the Transmitter Radiated Power Measurement</b></p> <p>In many cases, the RF output power limits for licensed digital transmission devices is specified in terms of effective radiated power (ERP) or equivalent isotropic radiated power (EIRP). Typically, ERP is specified when the operating frequency is less than or equal to 1 GHz and EIRP is specified when the operating frequency is greater than 1 GHz. Both are determined by adding the transmit antenna gain to the conducted RF output power with the primary difference between the two being that when determining the ERP, the transmit antenna gain is referenced to a dipole antenna (i.e., dBd) whereas when determining the EIRP, the transmit antenna gain is referenced to an</p>

	<p>isotropic antenna (dBi).</p> <p>Final measurement calculation as below:  The relevant equation for determining the ERP or EIRP from the conducted RF output power measured using the guidance provided above is:  <math display="block">\text{ERP/EIRP} = \text{PMeas} + \text{GT} - \text{LC}</math></p> <p>where:  ERP/EIRP = effective or equivalent radiated power, respectively (expressed in the same units as PMeas, typically dBW or dBm);</p> <p>PMeas = measured transmitter output power or PSD, in dBm or dBW; GT = gain of the transmitting antenna, in dBd (ERP) or dBi (EIRP); dBd (ERP)=dBi (EIRP) -2.15 dB  LC = signal attenuation in the connecting cable between the transmitter and antenna, in dB.</p> <p>For devices utilizing multiple antennas, KDB 662911 provides guidance for determining the effective array transmit antenna gain term to be used in the above equation.</p> <p>For example:  In the EIRP test, when PMeas value for GSM1900 is 30.2 dBm, LC is 0.6 dB, and GT is -3.4 dB, then final EIRP value is:  <math display="block">\text{EIRP for GSM1900} = 30.2 \text{ dBm} - 3.4 \text{ dBi} - 0.6 \text{ dB} = 26.2 \text{ dBm}</math></p> <p>The relevant equation for determining the ERP/EIRP from the radiated RF output power is:  <math display="block">\text{ERP/EIRP (dBm)} = \text{SA Read Value (dBm)} + \text{Correction Factor (dB)}</math></p> <p>where:  ERP/EIRP = effective or equivalent radiated power, in dBm;  SA Read Value = measured transmitter power received by EMI receiver or spectrum analyzer, in dBm; Correction Factor = total correction factor including cable loss, in dB;</p> <p>During the test, the data of Correction Factor (dB) is added in the EMI receiver or spectrum analyzer, so SA Read Value (dBm) is the final values which contains the data of Correction Factor (dB).</p> <p>For example:  In the ERP test, when SA read value for GSM850 is 21dBm, and correction factor is 8dB, then final ERP value for GSM850 is:  <math display="block">\text{ERP (dBm)} = 21\text{dBm} + 8\text{dB} = 29\text{dBm}</math></p>
Test Instruments:	Refer to section 3.0 for details
Test mode:	Refer to section 4.1 for details
Test results:	Pass (Please refer to ANNEX for the test results)

#### 4.4 Peak-to-Average Ratio

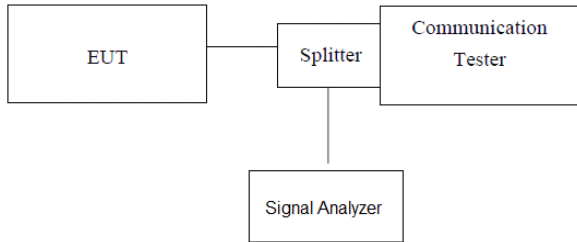
Test Requirement:	FCC part24.232(d)
Test Method:	FCC part2.1046
Limit:	13db
Test setup:	 <p><i>Note: Measurement setup for testing on Antenna connector</i></p>
Test Procedure:	<ol style="list-style-type: none"> <li>1. The transmitter output port was connected to base station.</li> <li>2. The RF output of EUT was connected to the Signal Analyzer by RF cable and attenuator, the path loss was compensated to the results for each measurement.</li> <li>3. Set EUT at maximum power through base station.</li> <li>4. Select lowest, middle, and highest channels for each band and different modulation.</li> <li>5. Measure the maximum burst average power.</li> <li>6. Record the maximum peak-to-average ratio value.</li> </ol>
Test Instruments:	Refer to section 3.0 for details
Test mode:	Refer to section 4.1 for details
Test results:	Pass (Please refer to ANNEX for the test results)

## 4.5 Occupy Bandwidth

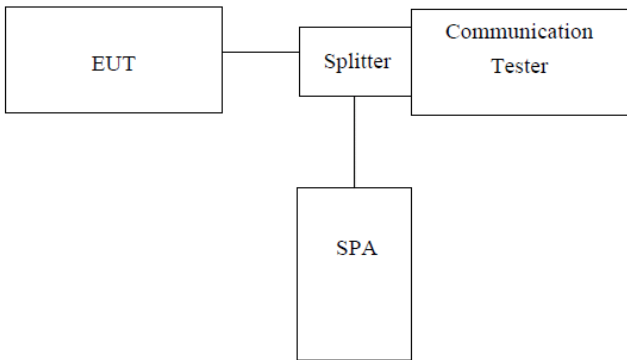
Test Requirement:	FCC part22.913(a) and FCC part24.232(b)
Test Method:	FCC part2.1049
Test setup:	 <p><i>Note: Measurement setup for testing on Antenna connector</i></p>
Test Procedure:	<ol style="list-style-type: none"> <li>1. The EUT's output RF connector was connected with a short cable to the spectrum analyzer</li> <li>2. RBW was set to about 1% of emission BW, VBW= 3 times RBW.</li> <li>3. -26dBc display line was placed on the screen (or 99% bandwidth), the occupied bandwidth is the delta frequency between the two points where the display line intersects the signal trace.</li> </ol>
Test Instruments:	Refer to section 3.0 for details
Test mode:	Refer to section 4.1 for details
Test results:	Pass (Please refer to ANNEX for the test results)

#### 4.6 Modulation Characteristic

According to FCC § 2.1047(d), Part 22H & 24E there is no specific requirement for digital modulation, therefore modulation characteristic is not presented.

#### 4.7 Out of band emission at antenna terminals

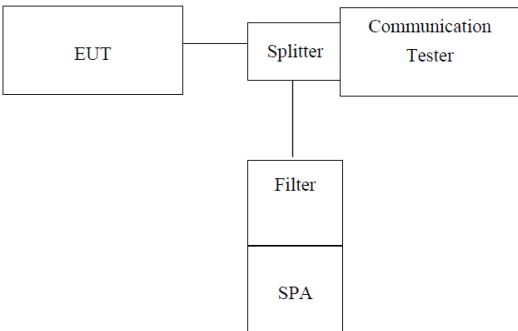
Test Requirement:	FCC part22.917(a) and FCC part24.238(a)
Test Method:	FCC part2.1051
Limit:	-13dBm
Test setup:	 <pre> graph LR     EUT[EUT] --- Splitter[Splitter]     Splitter --- CT[Communication Tester]     Splitter --- Filter[Filter]     Filter --- SPA[SPA]   </pre> <p><i>Note: Measurement setup for testing on Antenna connector</i></p>
Test Procedure:	<ol style="list-style-type: none"> <li>1 The RF output of the transceiver was connected to a spectrum analyzer through appropriate attenuation.</li> <li>2 The resolution bandwidth of the spectrum analyzer was set at 1MHz, sufficient scans were taken to show the out of band Emissions if any up to 10th harmonic.</li> <li>3 For the out of band: Set the RBW, VBW = 1MHz, Start=30MHz, Stop= 10th harmonic.</li> <li>4 Band Edge Requirements: In the 1 MHz bands immediately outside and adjacent to the frequency block, a resolution bandwidth of at least 1 percent of the emission bandwidth of the fundamental emission of the transmitter may be employed to measure the out of band Emissions.</li> </ol>
Test Instruments:	Refer to section 3.0 for details
Test mode:	Refer to section 4.1 for details
Test results:	Pass (Please refer to ANNEX for the test results)

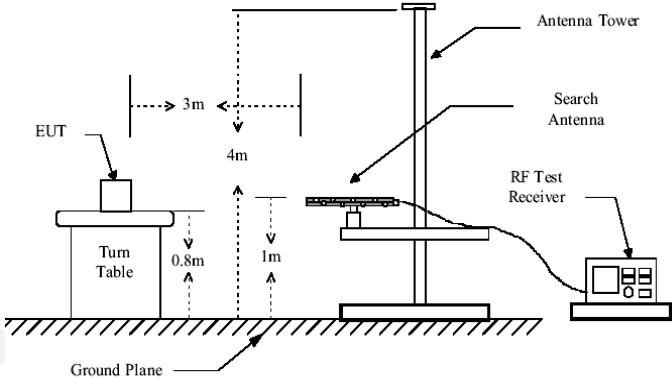
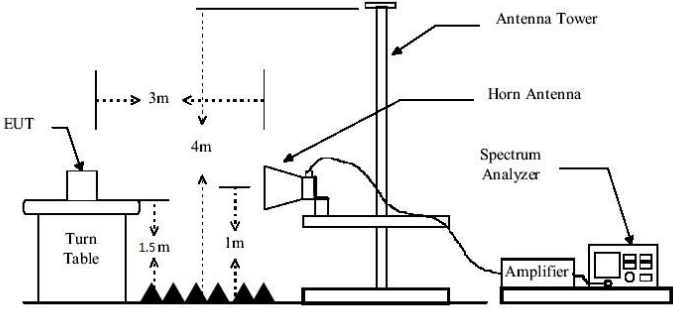
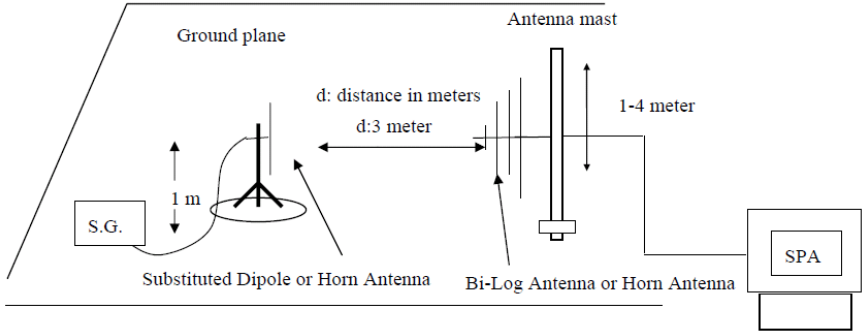

### 4.8 Field strength of spurious radiation measurement

Test Requirement:	FCC part22.917(a) and FCC part24.238(a)
Test Method:	FCC part2.1053
Limit:	-13dBm
Test setup:	<p>Below 1GHz</p>  <p>Above 1GHz</p>  <p>Substituted method:</p> 

Test Procedure:	<ol style="list-style-type: none"> <li>1. The EUT was placed on a non-conductive turntable using a non-conductive support. The radiated emission at the fundamental frequency was measured at 3 m with a test antenna and EMI spectrum analyzer.</li> <li>2. During the tests, the antenna height and the EUT azimuth were varied in order to identify the maximum level of emissions from the EUT. This maximization process was repeated with the EUT positioned in each of its three orthogonal orientations.</li> <li>3. The frequency range up to tenth harmonic was investigated for each of three fundamental frequency (low, middle and high channels). Once spurious emission was identified, the power of the emission was determined using the substitution method.</li> <li>4. The spurious emissions attenuation was calculated as the difference between radiated power at the fundamental frequency and the spurious emissions frequency.  <math display="block">\text{ERP / EIRP} = \text{S.G. output (dBm)} + \text{Antenna Gain(dB/dBi)} - \text{Cable Loss (dB)}</math> </li> </ol>
Test Instruments:	Refer to section 3.0 for details
Test mode:	Refer to section 4.1 for details
Test results:	Pass

## Measurement Data

Test mode:	GSM850		Test channel:	Lowest
Frequency (MHz)	Spurious Emission		Limit (dBm)	Result
	Polarization	Level (dBm)		
1648.40	Vertical	-36.33	-13.00	Pass
2472.60	V	-38.99		
3296.80	V	-37.70		
4121.00	V	-43.63		
4945.20	V	---		
1648.40	Horizontal	-38.59	-13.00	Pass
2472.60	H	-42.19		
3296.80	H	-45.27		
4121.00	H	-46.34		
4945.20	H	---		
Test mode:	GSM850		Test channel:	Middle
Frequency (MHz)	Spurious Emission		Limit (dBm)	Result
	Polarization	Level (dBm)		
1673.20	Vertical	-36.76	-13.00	Pass
2509.80	V	-39.85		
3346.40	V	-37.58		
4183.00	V	-43.71		
5019.60	V	---		
1673.20	Horizontal	-38.59	-13.00	Pass
2509.80	H	-42.64		
3346.40	H	-44.86		
4183.00	H	-46.39		
5019.60	H	---		
Test mode:	GSM850		Test channel:	Highest
Frequency (MHz)	Spurious Emission		Limit (dBm)	Result
	Polarization	Level (dBm)		
1697.60	Vertical	-37.26	-13.00	Pass
2546.40	V	-39.71		
3395.20	V	-38.15		
4244.00	V	-43.25		
5092.80	V	---		
1697.60	Horizontal	-39.35	-13.00	Pass
2546.40	H	-42.90		
3395.20	H	-44.89		
4244.00	H	-46.22		
5092.80	H	---		

Test mode:	GPRS 850		Test channel:	Lowest
Frequency (MHz)	Spurious Emission		Limit (dBm)	Result
	Polarization	Level (dBm)		
1648.40	Vertical	-36.63	-13.00	Pass
2472.60	V	-39.60		
3296.80	V	-38.10		
4121.00	V	-42.85		
4945.20	V	---		
1648.40	Horizontal	-39.46	-13.00	Pass
2472.60	H	-42.75		
3296.80	H	-44.97		
4121.00	H	-45.60		
4945.20	H	---		
Test mode:	GPRS 850		Test channel:	Middle
Frequency (MHz)	Spurious Emission		Limit (dBm)	Result
	Polarization	Level (dBm)		
1673.20	Vertical	-37.26	-13.00	Pass
2509.80	V	-39.73		
3346.40	V	-38.45		
4183.00	V	-42.94		
5019.60	V	---		
1673.20	Horizontal	-39.33	-13.00	Pass
2509.80	H	-42.49		
3346.40	H	-44.77		
4183.00	H	-46.06		
5019.60	H	---		
Test mode:	GPRS 850		Test channel:	Highest
Frequency (MHz)	Spurious Emission		Limit (dBm)	Result
	Polarization	Level (dBm)		
1697.60	Vertical	-37.04	-13.00	Pass
2546.40	V	-39.71		
3395.20	V	-38.14		
4244.00	V	-42.99		
5092.80	V	---		
1697.60	Horizontal	-39.06	-13.00	Pass
2546.40	H	-42.30		
3395.20	H	-44.90		
4244.00	H	-45.69		
5092.80	H	---		

Test mode:	EGPRS 850		Test channel:	Lowest
Frequency (MHz)	Spurious Emission		Limit (dBm)	Result
	Polarization	Level (dBm)		
1648.40	Vertical	-36.91	-13.00	Pass
2472.60	V	-39.34		
3296.80	V	-37.77		
4121.00	V	-42.91		
4945.20	V	---		
1648.40	Horizontal	-39.50	-13.00	Pass
2472.60	H	-42.23		
3296.80	H	-44.97		
4121.00	H	-46.12		
4945.20	H	---		
Test mode:	EGPRS 850		Test channel:	Middle
Frequency (MHz)	Spurious Emission		Limit (dBm)	Result
	Polarization	Level (dBm)		
1673.20	Vertical	-36.41	-13.00	Pass
2509.80	V	-39.36		
3346.40	V	-38.33		
4183.00	V	-43.78		
5019.60	V	---		
1673.20	Horizontal	-38.71	-13.00	Pass
2509.80	H	-42.64		
3346.40	H	-44.91		
4183.00	H	-45.69		
5019.60	H	---		
Test mode:	EGPRS 850		Test channel:	Highest
Frequency (MHz)	Spurious Emission		Limit (dBm)	Result
	Polarization	Level (dBm)		
1697.60	Vertical	-36.92	-13.00	Pass
2546.40	V	-39.30		
3395.20	V	-38.00		
4244.00	V	-43.73		
5092.80	V	---		
1697.60	Horizontal	-39.47	-13.00	Pass
2546.40	H	-42.07		
3395.20	H	-45.22		
4244.00	H	-46.35		
5092.80	H	---		

Remark :

1. The emission behaviour belongs to narrowband spurious emission.
2. Remark"---" means that the emission level is too low to be measured
3. The emission levels of below 1 GHz are very lower than the limit and not show in test report.

Test mode:	PCS1900		Test channel:	Lowest
Frequency (MHz)	Spurious Emission		Limit (dBm)	Result
	Polarization	Level (dBm)		
3700.40	Vertical	-36.73	-13.00	Pass
5550.60	V	-39.74		
7400.80	V	-38.10		
9251.00	V	-43.06		
11101.20	V	---		
3700.40	Horizontal	-39.40	-13.00	Pass
5550.60	H	-42.56		
7400.80	H	-44.67		
9251.00	H	-45.73		
11101.20	H	---		
Test mode:	PCS1900		Test channel:	Middle
Frequency (MHz)	Spurious Emission		Limit (dBm)	Result
	Polarization	Level (dBm)		
3760.00	Vertical	-37.07	-13.00	Pass
5640.00	V	-39.41		
7520.00	V	-37.54		
9400.00	V	-42.86		
11280.00	V	---		
3760.00	Horizontal	-39.17	-13.00	Pass
5640.00	H	-42.10		
7520.00	H	-45.06		
9400.00	H	-45.64		
11280.00	H	---		
Test mode:	PCS1900		Test channel:	Highest
Frequency (MHz)	Spurious Emission		Limit (dBm)	Result
	Polarization	Level (dBm)		
3819.60	Vertical	-37.05	-13.00	Pass
5729.40	V	-39.40		
7639.20	V	-38.08		
9549.00	V	-42.90		
11458.80	V	---		
3819.60	Horizontal	-38.81	-13.00	Pass
5729.40	H	-42.45		
7639.20	H	-45.07		
9549.00	H	-46.33		
11458.80	H	---		

Test mode:	GPRS 1900		Test channel:	Lowest
Frequency (MHz)	Spurious Emission		Limit (dBm)	Result
	Polarization	Level (dBm)		
1648.40	Vertical	-37.23	-13.00	Pass
2472.60	V	-39.23		
3296.80	V	-38.22		
4121.00	V	-42.91		
4945.20	V	---		
1648.40	Horizontal	-39.07	-13.00	Pass
2472.60	H	-42.25		
3296.80	H	-45.05		
4121.00	H	-45.97		
4945.20	H	---		
Test mode:	GPRS 1900		Test channel:	Middle
Frequency (MHz)	Spurious Emission		Limit (dBm)	Result
	Polarization	Level (dBm)		
1673.20	Vertical	-36.86	-13.00	Pass
2509.80	V	-39.38		
3346.40	V	-37.63		
4183.00	V	-42.97		
5019.60	V	---		
1673.20	Horizontal	-39.04	-13.00	Pass
2509.80	H	-43.06		
3346.40	H	-44.93		
4183.00	H	-46.37		
5019.60	H	---		
Test mode:	GPRS 1900		Test channel:	Highest
Frequency (MHz)	Spurious Emission		Limit (dBm)	Result
	Polarization	Level (dBm)		
1697.60	Vertical	-37.08	-13.00	Pass
2546.40	V	-39.34		
3395.20	V	-37.62		
4244.00	V	-43.34		
5092.80	V	---		
1697.60	Horizontal	-39.45	-13.00	Pass
2546.40	H	-42.44		
3395.20	H	-45.00		
4244.00	H	-46.08		
5092.80	H	---		

Test mode:	EGPRS 1900		Test channel:	Lowest
Frequency (MHz)	Spurious Emission		Limit (dBm)	Result
	Polarization	Level (dBm)		
1648.40	Vertical	-36.51	-13.00	Pass
2472.60	V	-39.55		
3296.80	V	-37.88		
4121.00	V	-43.26		
4945.20	V	---		
1648.40	Horizontal	-38.69	-13.00	Pass
2472.60	H	-42.37		
3296.80	H	-44.93		
4121.00	H	-46.07		
4945.20	H	---		
Test mode:	EGPRS 1900		Test channel:	Middle
Frequency (MHz)	Spurious Emission		Limit (dBm)	Result
	Polarization	Level (dBm)		
1673.20	Vertical	-37.26	-13.00	Pass
2509.80	V	-39.78		
3346.40	V	-37.59		
4183.00	V	-43.67		
5019.60	V	---		
1673.20	Horizontal	-38.73	-13.00	Pass
2509.80	H	-42.50		
3346.40	H	-45.31		
4183.00	H	-46.45		
5019.60	H	---		
Test mode:	EGPRS 1900		Test channel:	Highest
Frequency (MHz)	Spurious Emission		Limit (dBm)	Result
	Polarization	Level (dBm)		
1697.60	Vertical	-37.28	-13.00	Pass
2546.40	V	-39.42		
3395.20	V	-38.32		
4244.00	V	-43.36		
5092.80	V	---		
1697.60	Horizontal	-39.15	-13.00	Pass
2546.40	H	-43.06		
3395.20	H	-44.56		
4244.00	H	-45.94		
5092.80	H	---		

## Remark:

1. The emission behaviour belongs to narrowband spurious emission.
2. Remark"---" means that the emission level is too low to be measured
3. The emission levels of below 1 GHz are very lower than the limit and not show in test report.

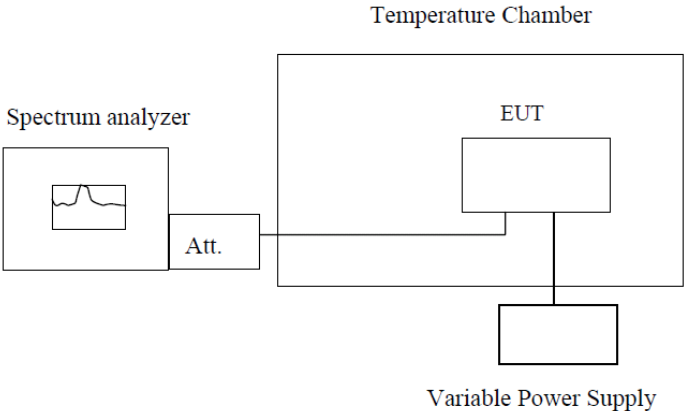

## 4.9 Frequency stability measurement

Test Requirement:	Part 2.1055(a)(1)(b), Part 2.1055(d)(1)(2)
Test Method:	ANSI C63.26:2015
Limit:	2.5ppm
Test setup:	 <p style="text-align: center;"><b>Note :</b> Measurement setup for testing on Antenna connector</p>
Test procedure:	<ol style="list-style-type: none"> <li>1. The equipment under test was connected to an external DC power supply and input rated voltage.</li> <li>2. RF output was connected to a frequency counter or spectrum analyzer via feed through attenuators.</li> <li>3. The EUT was placed inside the temperature chamber.</li> <li>4. Set the spectrum analyzer RBW low enough to obtain the desired frequency resolution and measure EUT 25°C operating frequency as reference frequency.</li> <li>5. Turn EUT off and set the chamber temperature to –20°C. After the temperature stabilized for approximately 30 minutes recorded the frequency.</li> <li>6. Repeat step measure with 10°C increased per stage until the highest temperature of +50°C reached.</li> <li>7. Reduce the input voltage to specified extreme voltage variation (+/- 15%) and endpoint, record the maximum frequency change.</li> </ol>
Test Instruments:	Refer to section 3.0 for details
Test mode:	Refer to section 4.1 for details
Test results:	Pass (Please refer to ANNEX for the test results)

#### 4.10 Photos of test setup

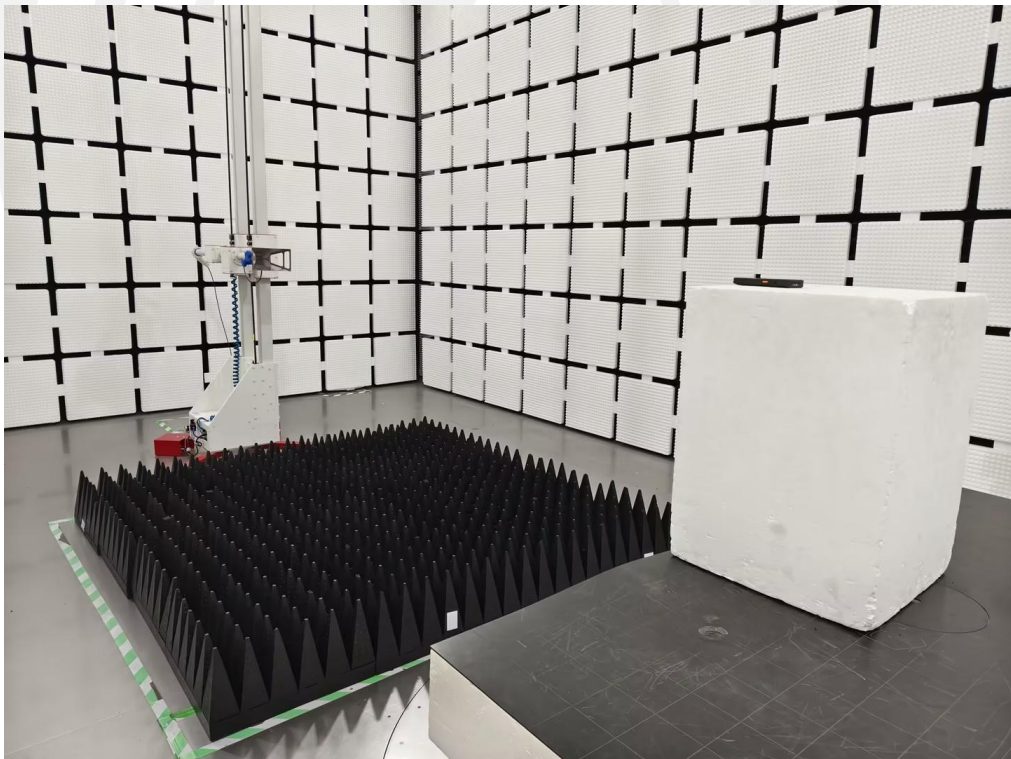
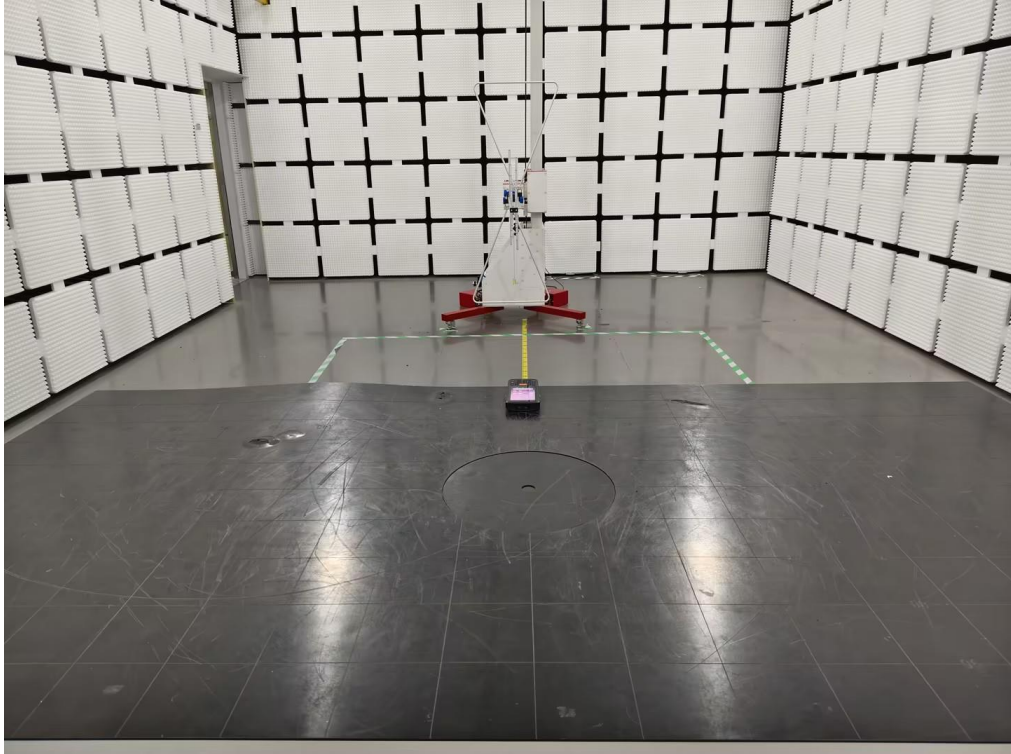

-----End-----