



TAOGLAS®



Datasheet

Shockwave 868/915MHz

Part No:
TLS.90.205111

Description:

Shockwave 868/915MHz Permanent Mount External Antenna
With 2m TGC-200 Cable & SMA(M) Connector

Features:

High Efficiency 868/915MHz Permanent Mount Antenna
Mechanically Robust for Indoor/Outdoor Applications
Vandal Resistant
Height: 79.5mm (3.13")
Diameter: 42mm (1.65")
IP69K Rating
Connector: SMA Male
Cable: 2m Low loss TGC-200
RoHS & REACH Compliant

1. Introduction	3
2. Specifications	4
3. Antenna Characteristics	5
4. 2D & 3D Radiation Patterns	7
5. Mechanical Drawing	14
6. Packaging	15
7. Installation	16
8. Application Note	17
<hr/>	
Changelog	19

Taoglas makes no warranties based on the accuracy or completeness of the contents of this document and reserves the right to make changes to specifications and product descriptions at any time without notice. Taoglas reserves all rights to this document and the information contained herein.

Reproduction, use or disclosure to third parties without express permission is strictly prohibited.

Copyright © Taoglas

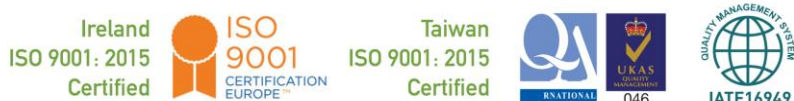

1. Introduction

SMA Male Connector



The Shockwave TLS.90.205111 is a mechanically robust, IP69K rated, external antenna operating at both 868MHz and 915MHz with 2 meter of low loss TGC-200 and SMA(M) connector. It has been designed to be used on a Ground Plane.

Typical applications include:

- Public safety
- Smart meters
- Mesh networks
- Transportation

The antenna has greater than 60% efficiency and 1.58dBi peak gain at 868MHz 64% efficiency and 1.9dBi peak gain at ISM 915MHz on a 30x30 cm ground plane. Stable radiation patterns over low angles provide consistent gain in the horizontal plane, meaning that it is especially suitable for mesh networks or hot spots.

A unique indent tab on the base of the antenna allows a wrench to be used to solidly lock the antenna on top of its mounting location while tightening up the nut beneath the metal panel. Waterproof O-rings around the bottom base prevent water from leaking under the antenna. The TLS.90 antenna is IP69K rated against high pressure water jets in commercial cleaning environments, which makes the antenna ideal for 868 & 915MHz applications in harsh outdoor environments.

The Cable and Connector are fully customizable, for more information or installation instructions please contact your regional Taoglas Customer Support Team.

2. Specifications

Electrical						
Frequency (MHz)	850	868	880	902	915	928
Peak Gain (dBi)						
With Ground plane(30x30cm)	1.67	1.58	1.57	1.61	1.9	2.46
Average Gain (dBi)						
With Ground plane(30x30cm)	-2.04	-2.17	-2.26	-2.22	-1.89	-1.35
Efficiency (%)						
With Ground plane(30x30cm)	62.52	60.67	59.43	59.98	64.71	73.28
Return Loss (dB)	< -20					
Impedance	50Ω					
Polarization	Linear					
Radiation Pattern	Omni-Directional					
Input Power	100W					
Mechanical						
Height	Height: 79.45mm (3.13")					
Base Diameter	42mm (1.65")					
Weight (g)	245g					
Material	Housing: UV Resistant ABS, Base: Nickel Plated Zinc Alloy					
Connector	SMA Male					
Cable	2 meters TGC-200					
Rec. Torque for Mounting	4.018N.m					
Max. Torque for Mounting	9.8N.m					
Environmental						
Waterproof Rating	IP67 and IP69K					
Temperature Range	-40°C to 85°C					
Humidity	Non-condensing 65°C 95% RH					

3. Antenna Characteristics

3.1 Return Loss

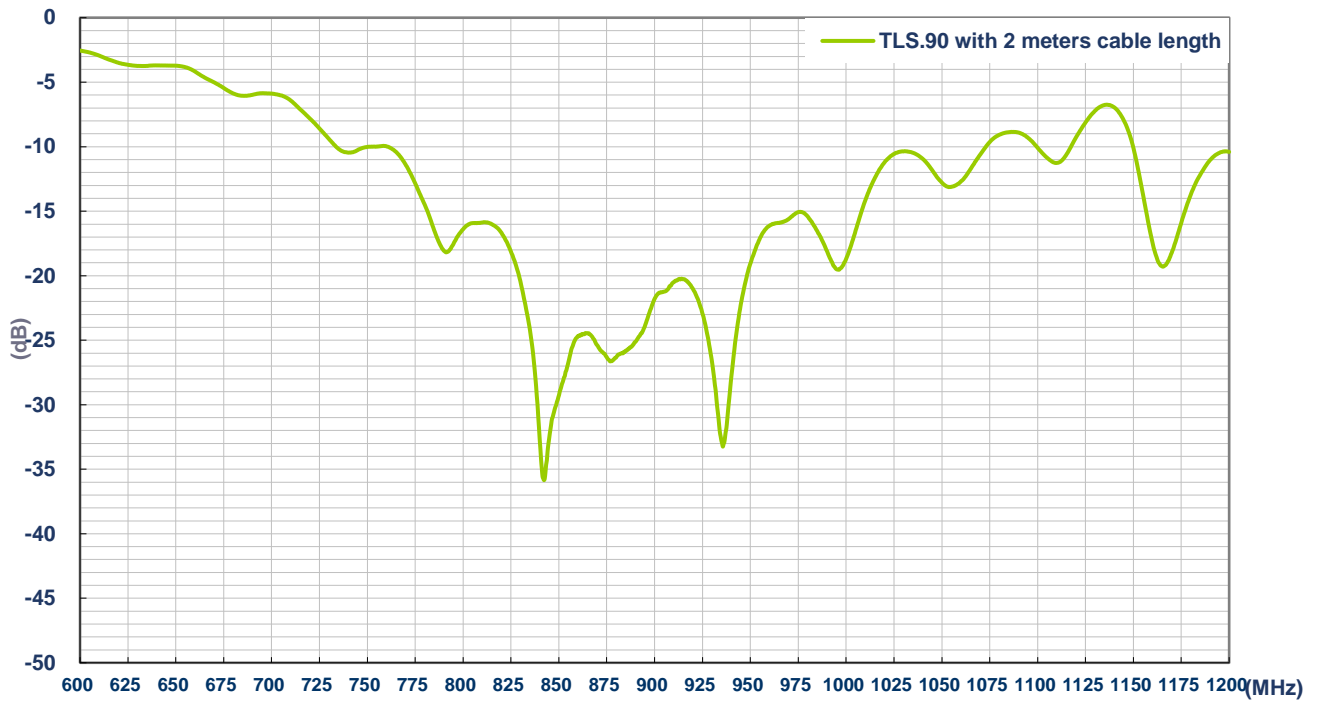

3.2 Efficiency

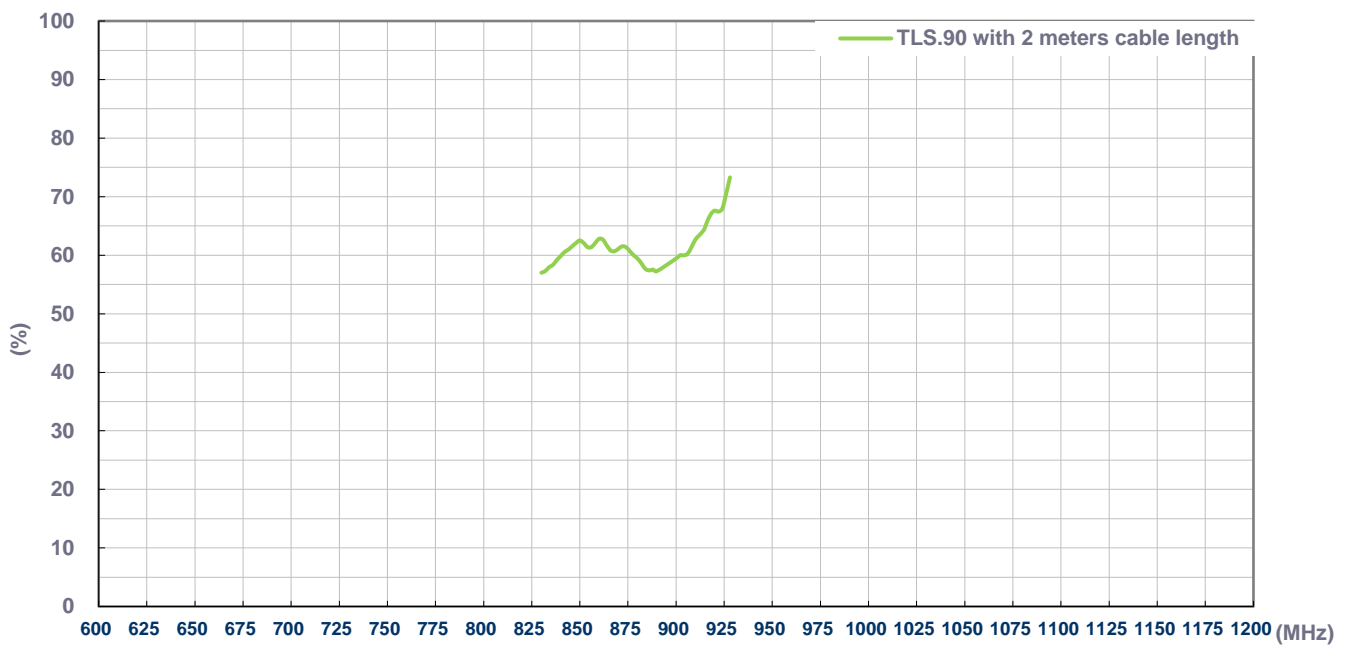

3.3 Average Gain

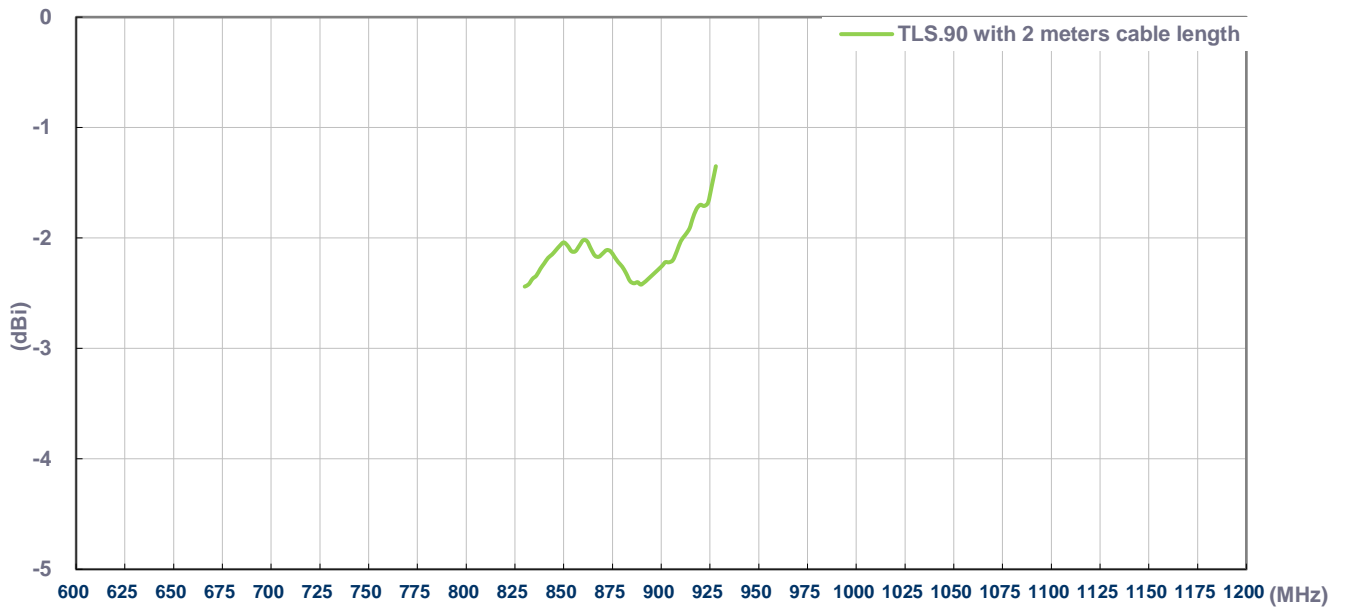

3.4 Peak Gain

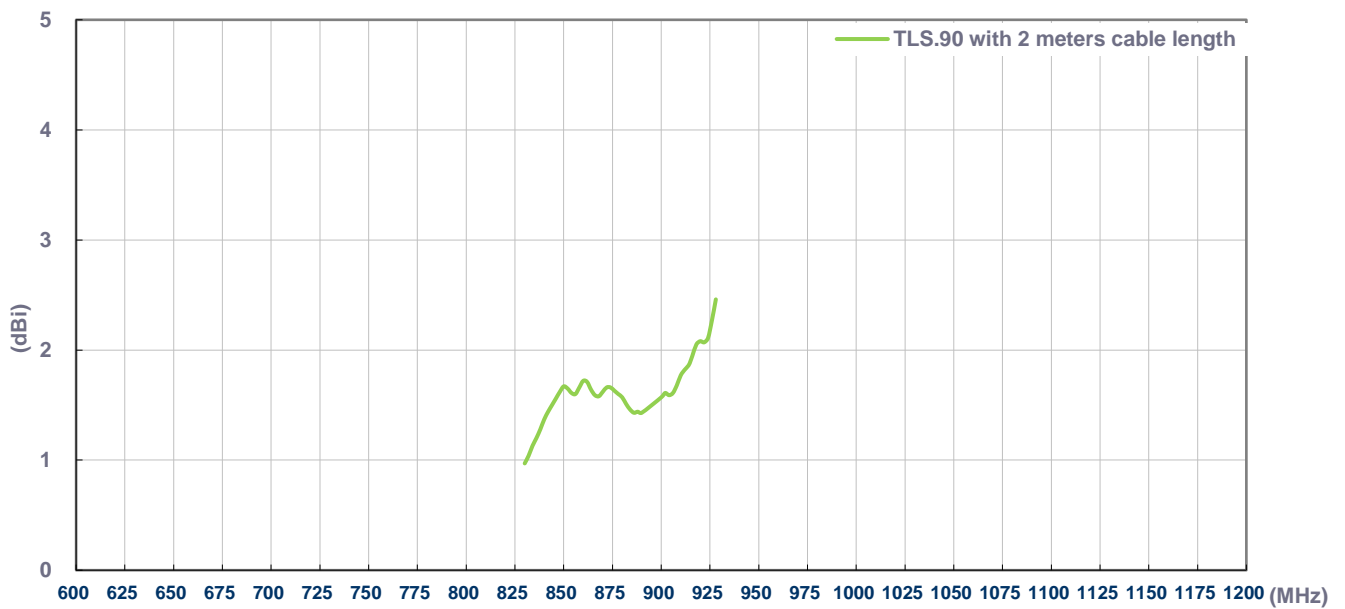

4. Radiation Patterns

4.1 Test Setup

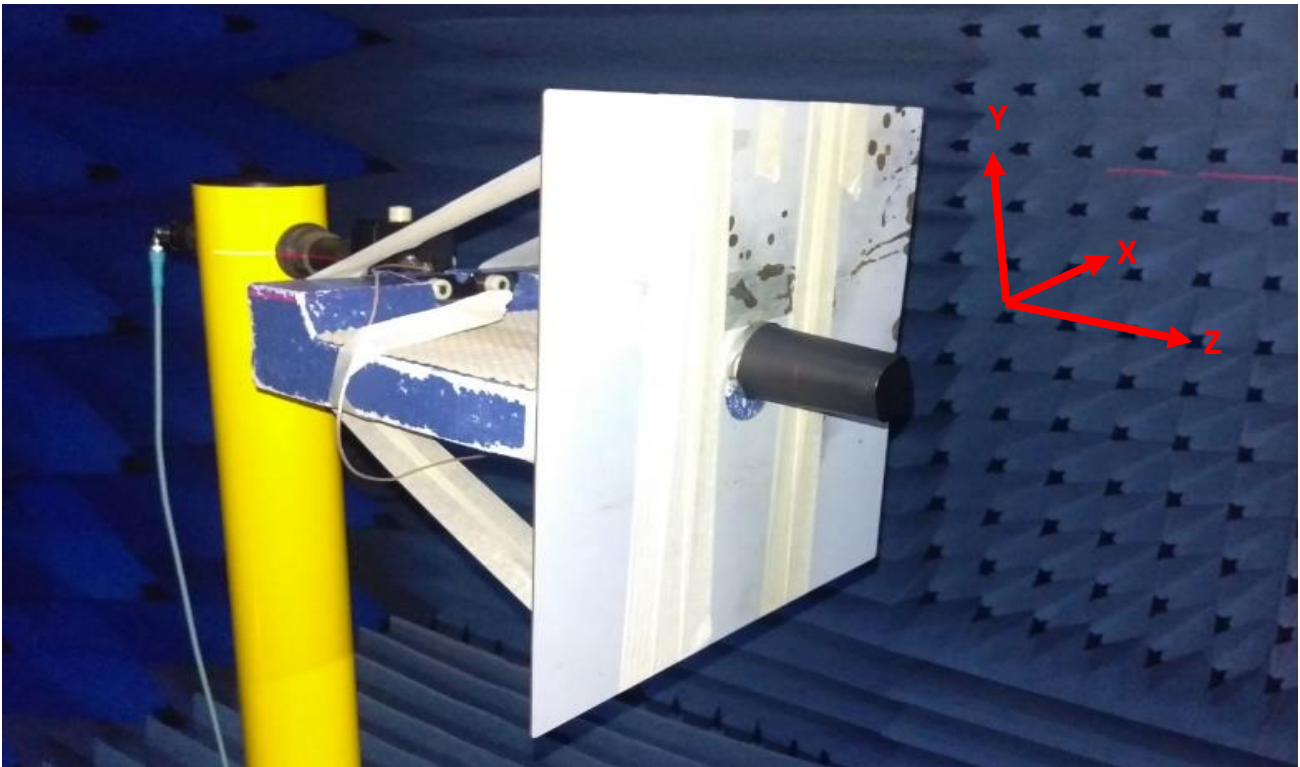

300*300mm Metal Ground Plane

4.2 2D & 3D Radiation Patterns

850MHz

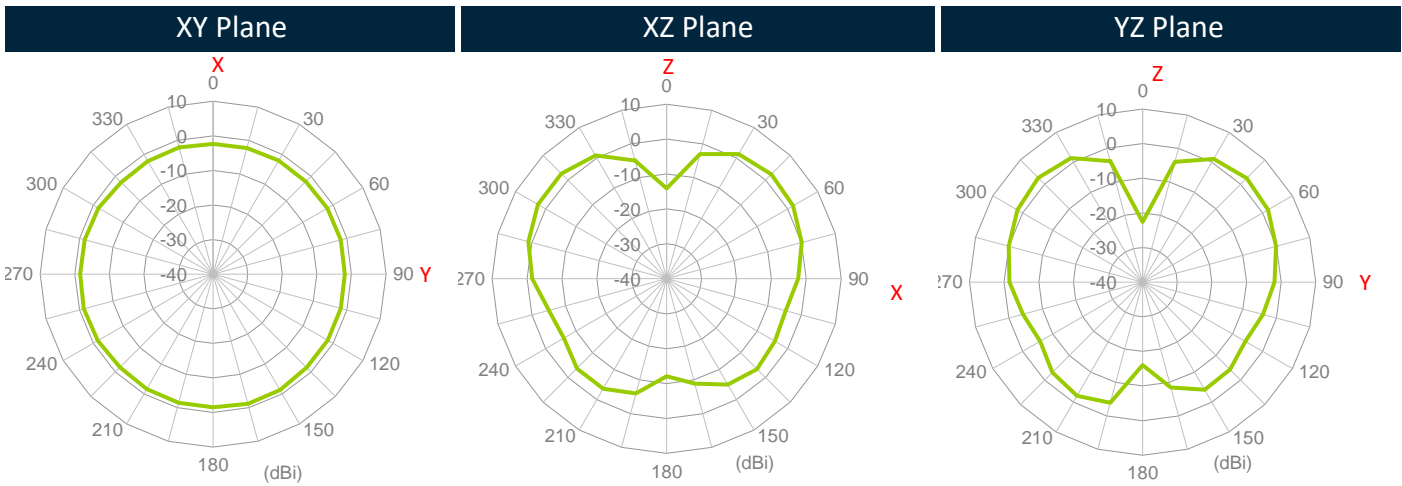
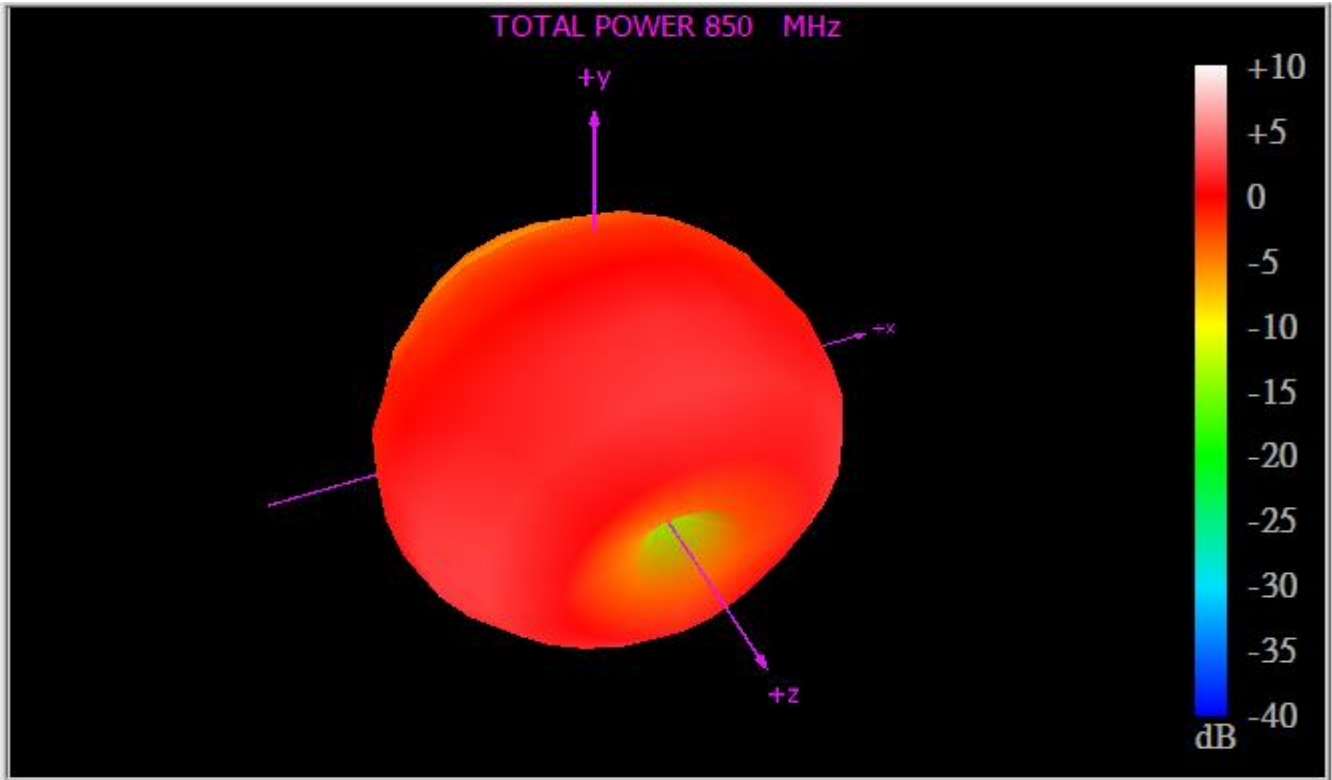

868MHz

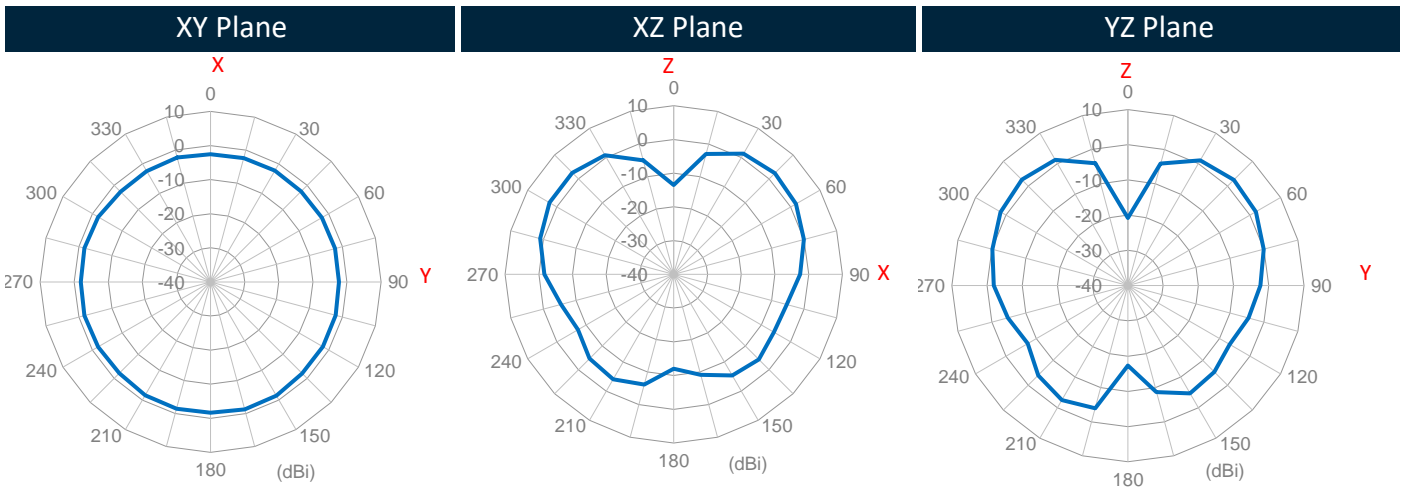
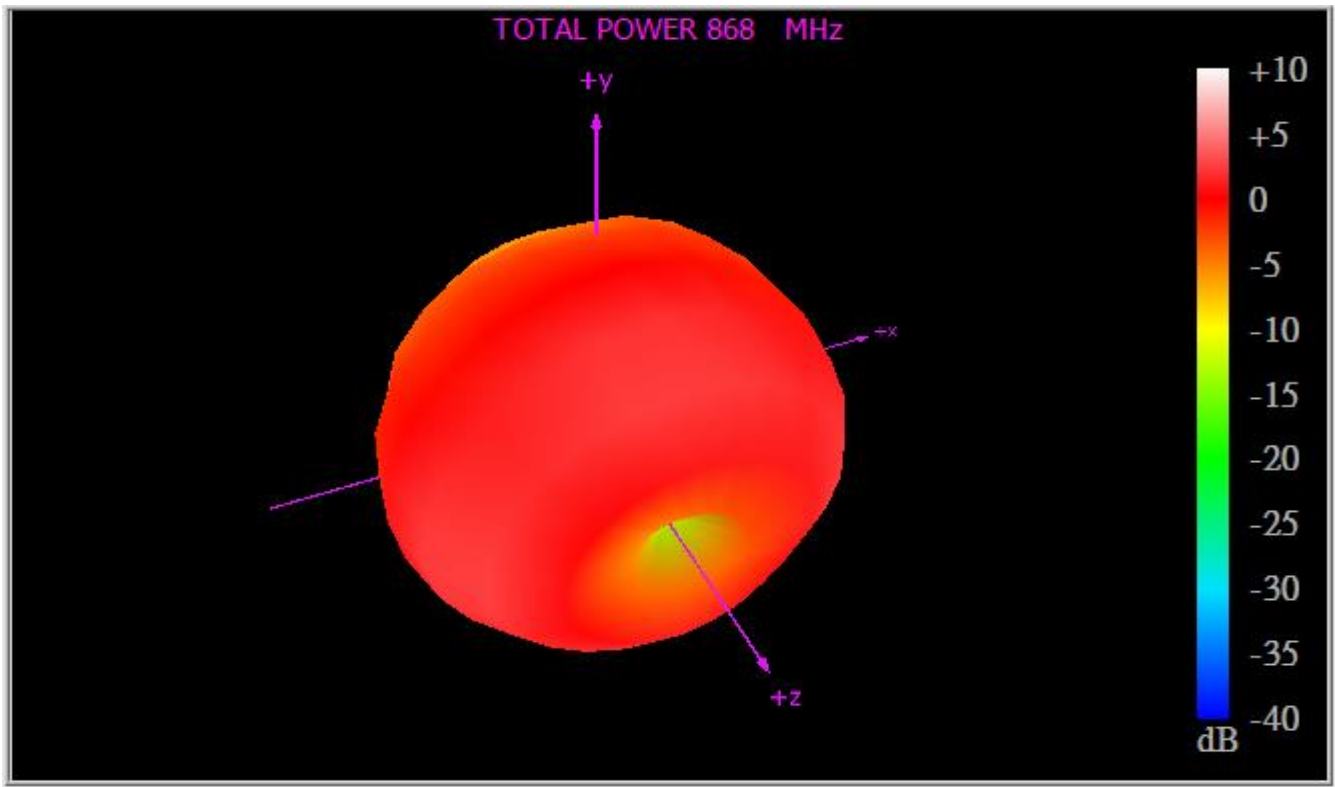

880MHz

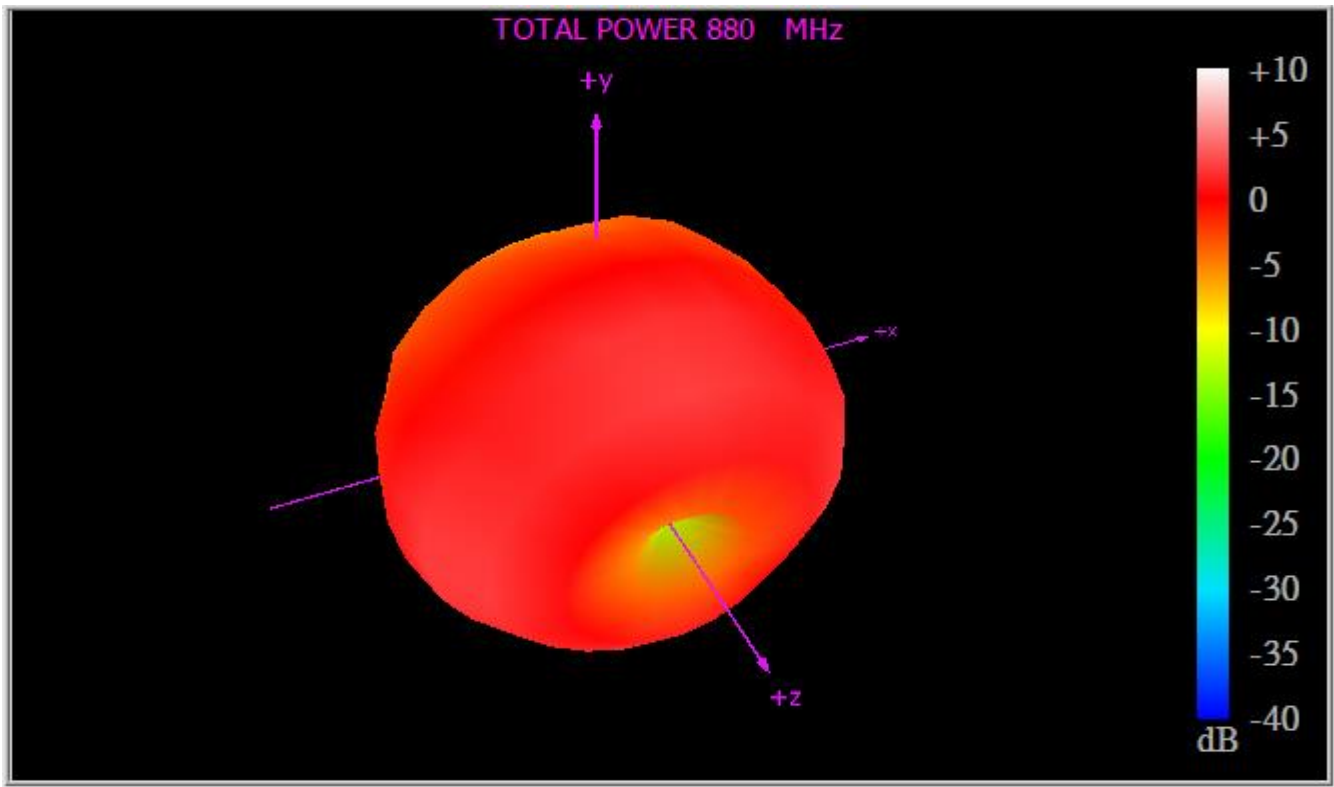

XY Plane

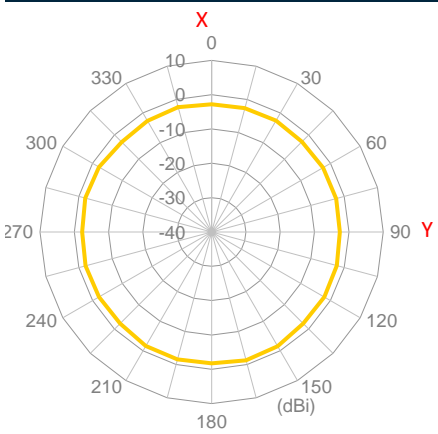

XZ Plane

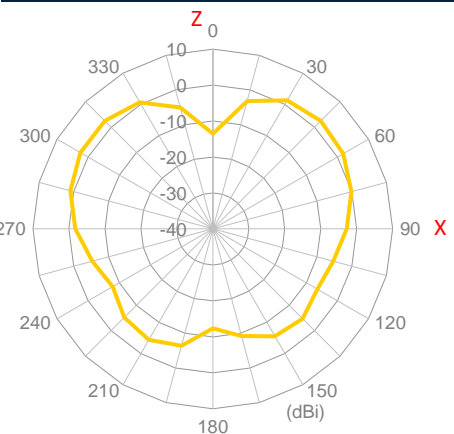

YZ Plane

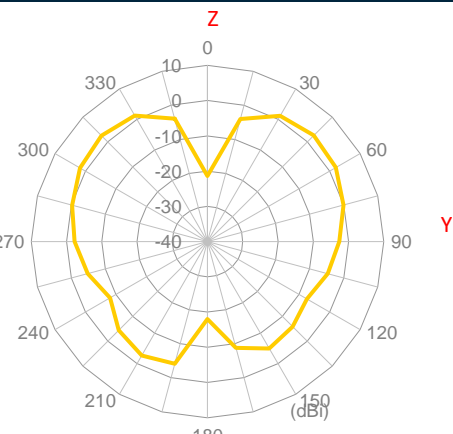

902MHz

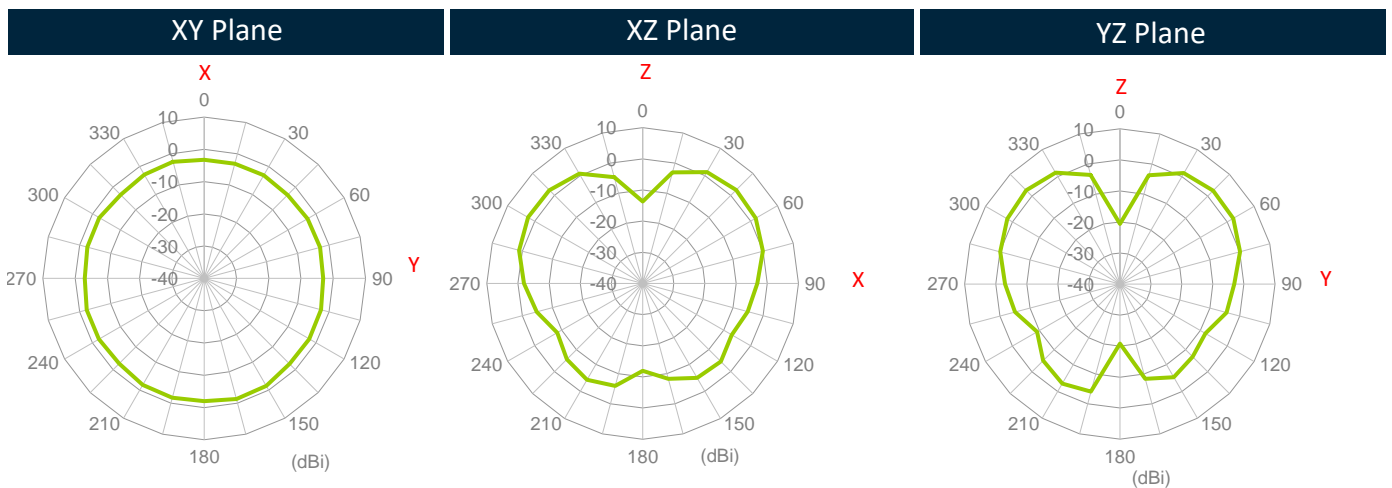
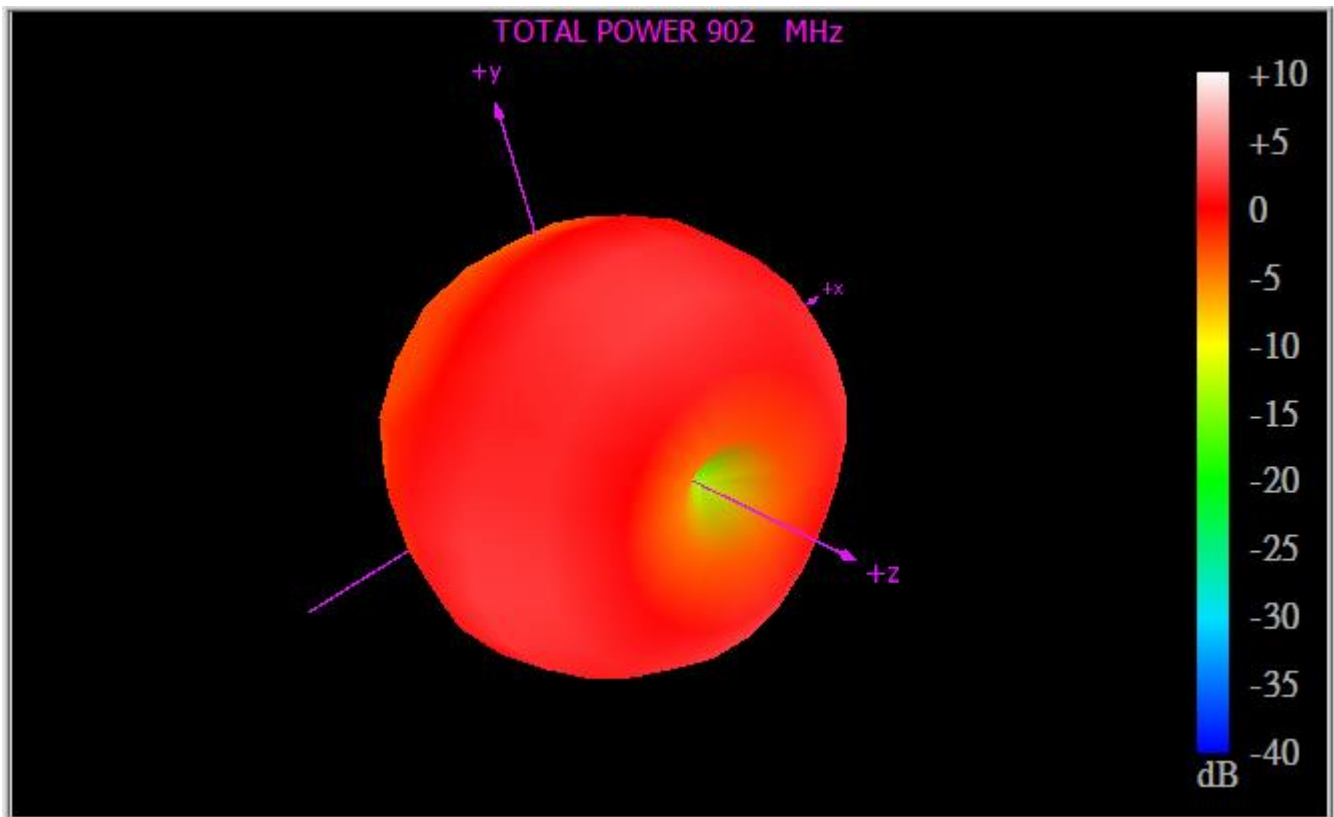

915MHz

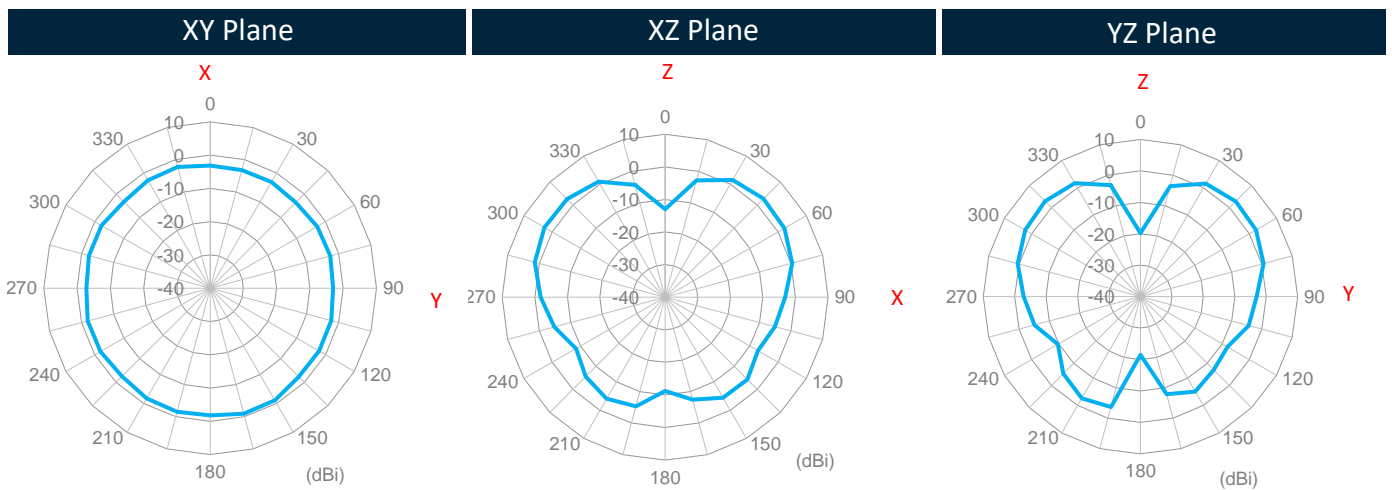
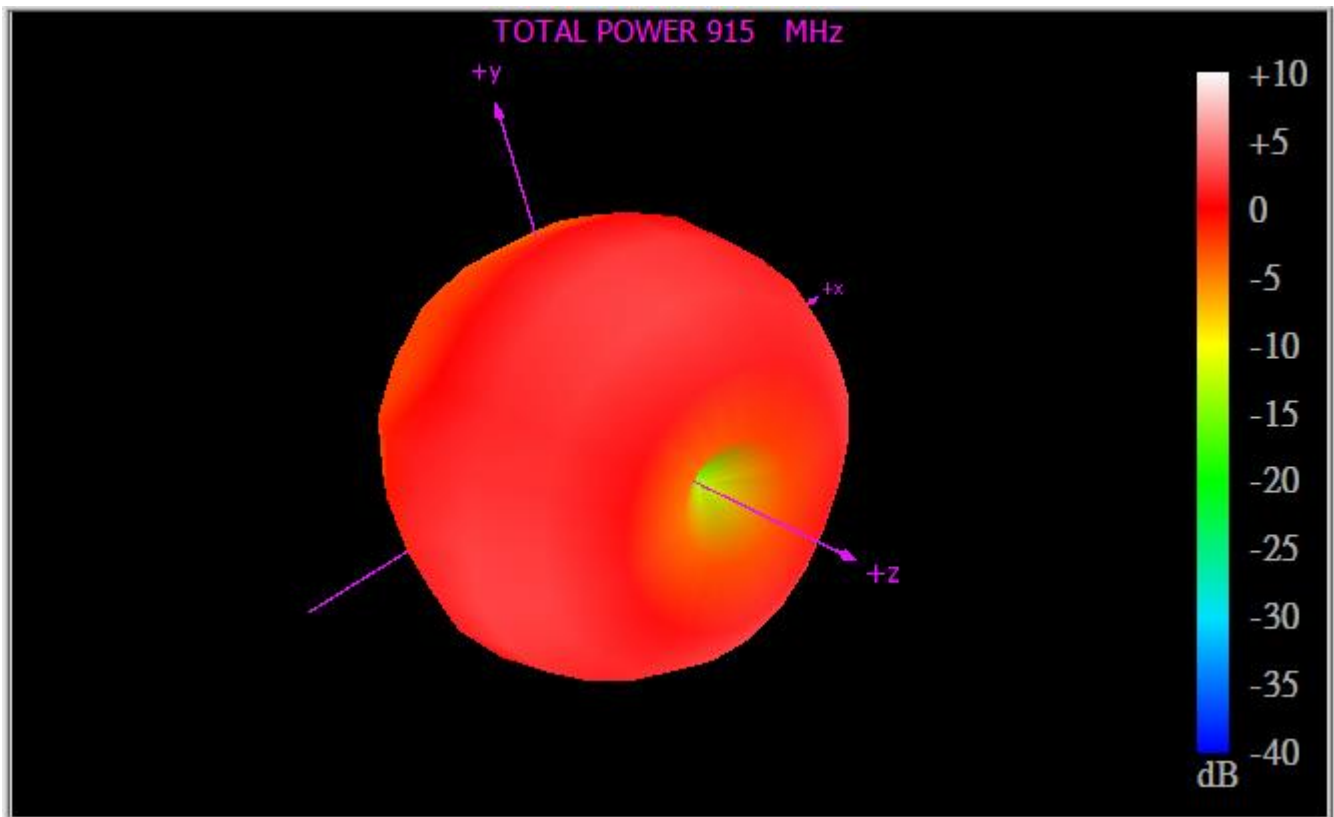

928MHz

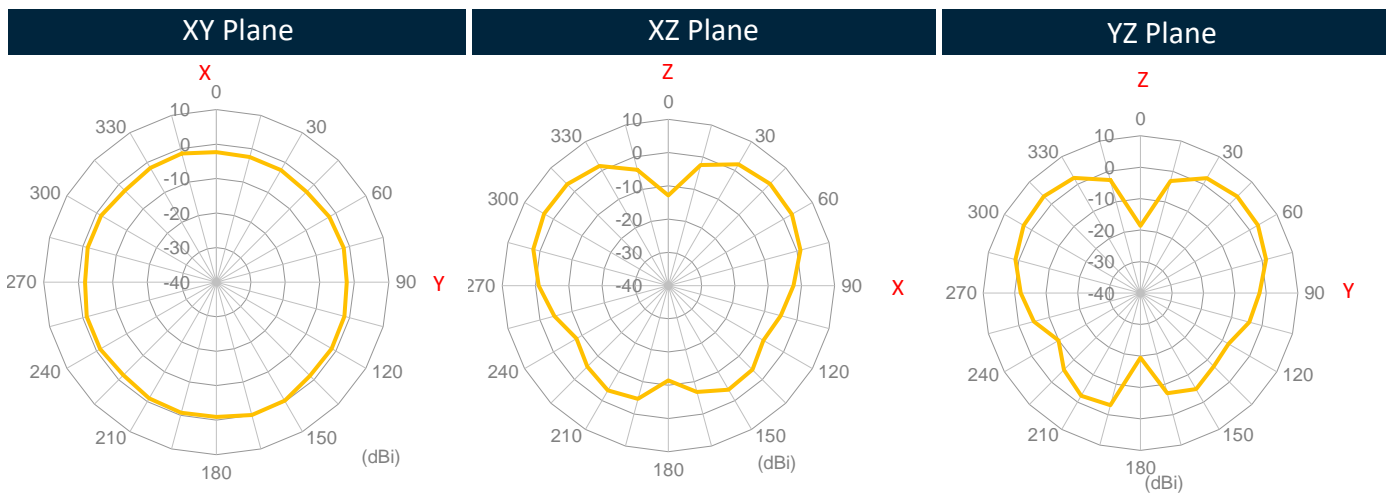
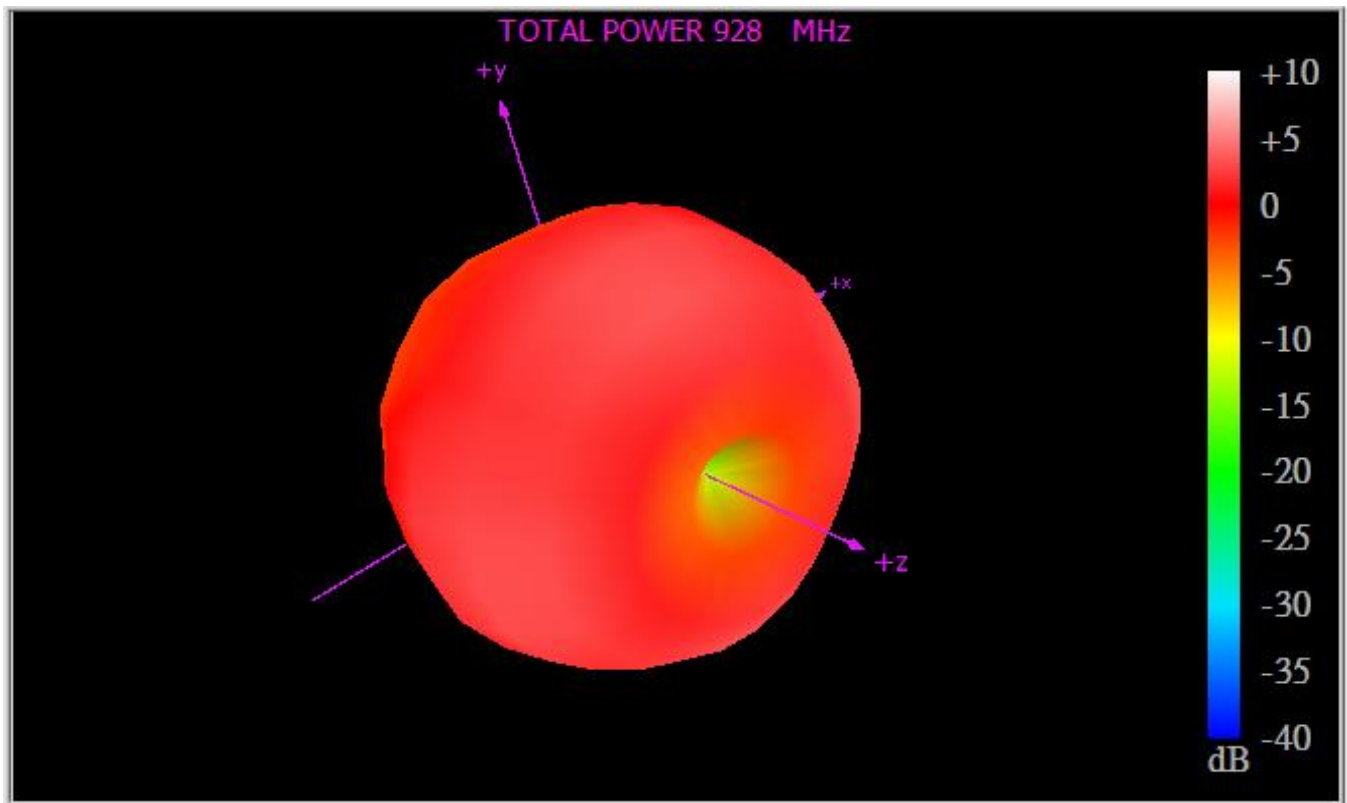

5. Mechanical Drawing (Units: mm)

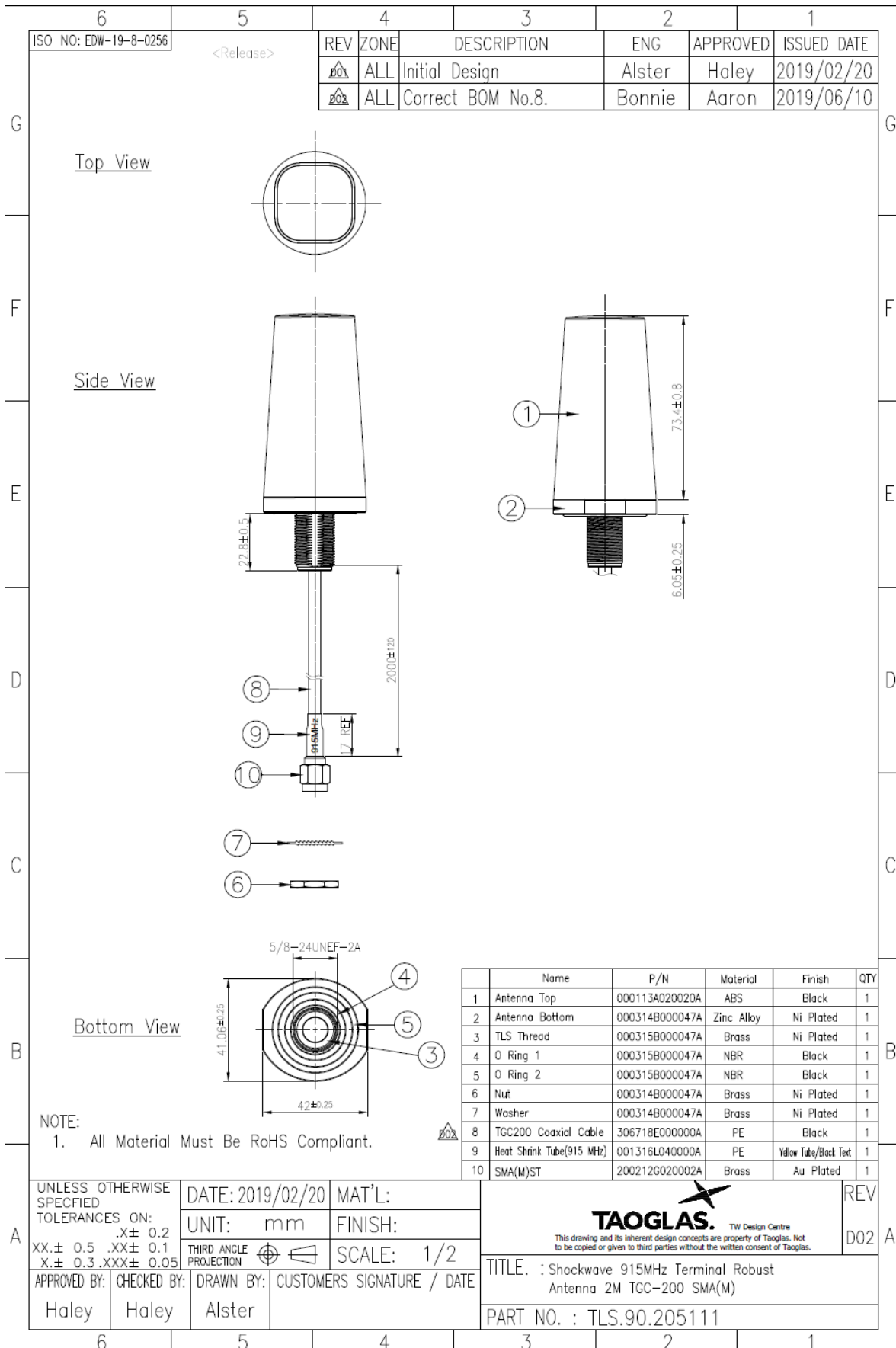

6. Packaging

1pc TLS.90.205111 per Small Box
 Dimensions: 135*135*135mm
 Weight: 370g

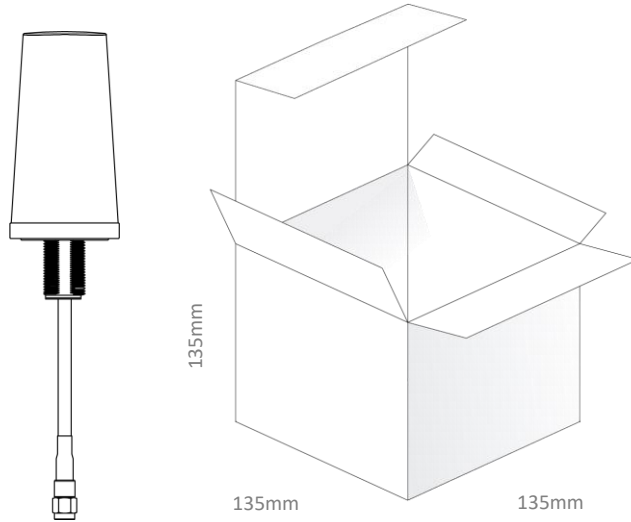

24pcs TLS.90.205111 per Carton
 Carton Dimensions: 430*380*280mm
 Weight: 10.2Kg

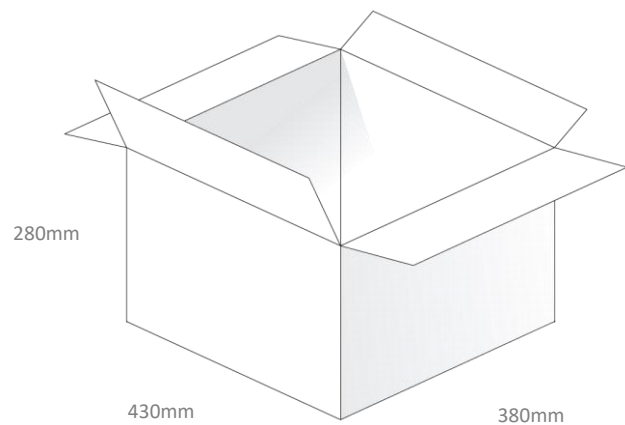

Pallet Dimensions:
 1100*1100*1510mm
 16 Cartons per Pallet
 4 Cartons per layer, 4 Layers

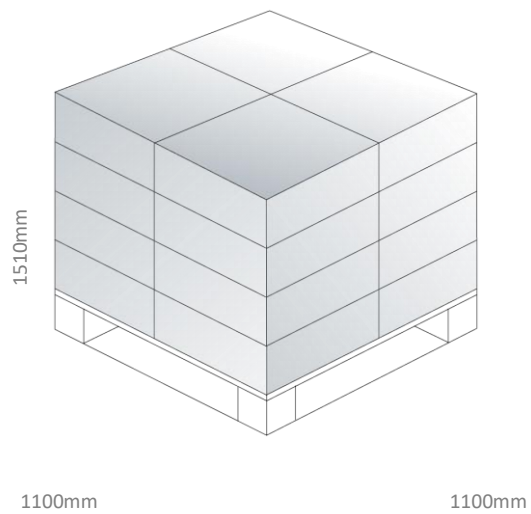

7. Installation

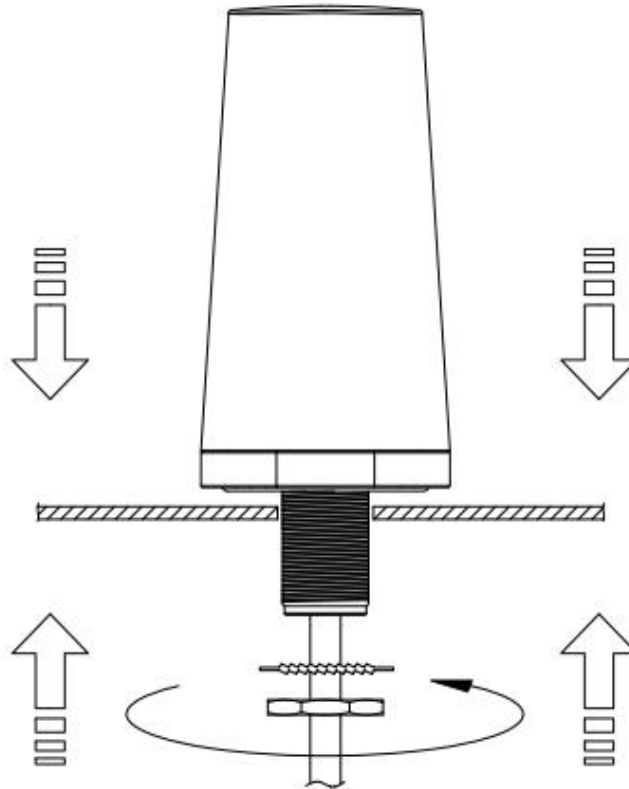

Recommended torque for mounting is 4.018 N.m or 41 kgf.cm

Maximum torque for mounting is 9.8 N.m or 100 kgf.cm

8. Application Note(with different cable length)

8.1 Return Loss

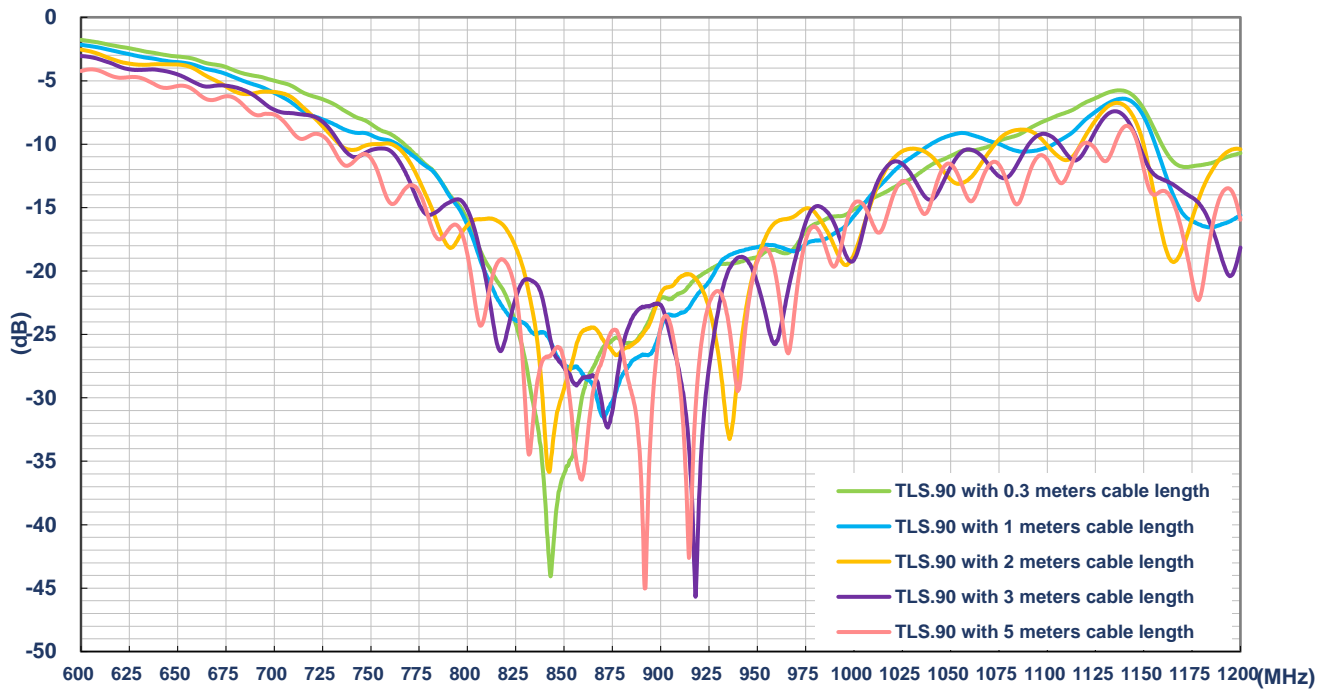

8.2 Efficiency

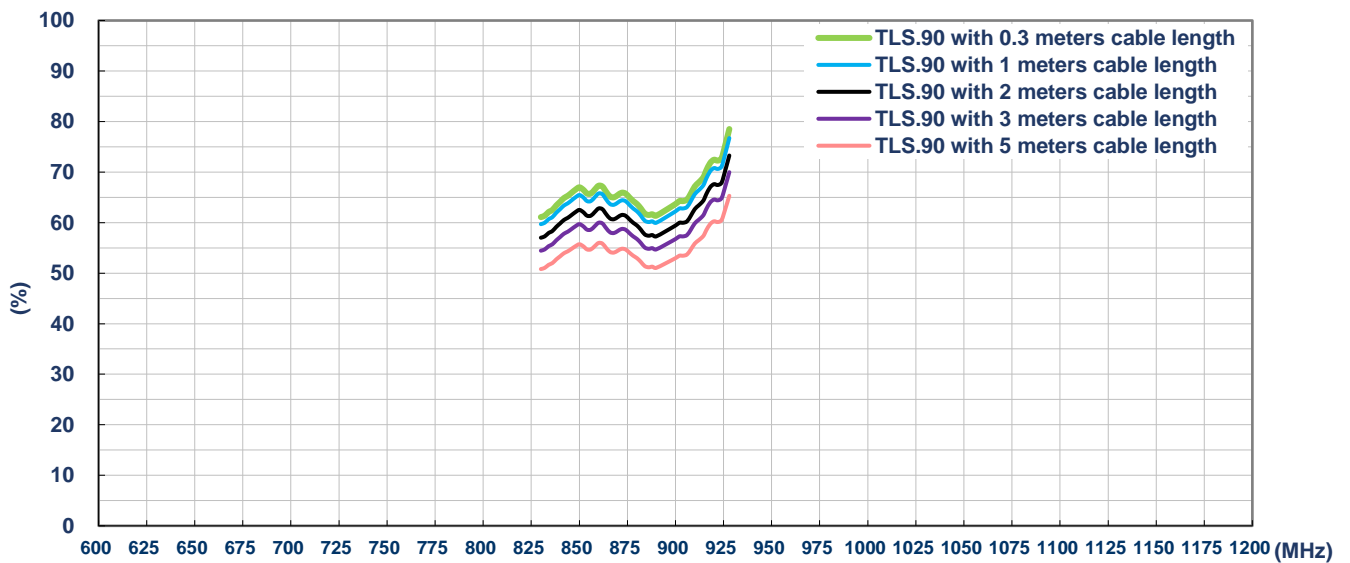

8.3 Average Gain

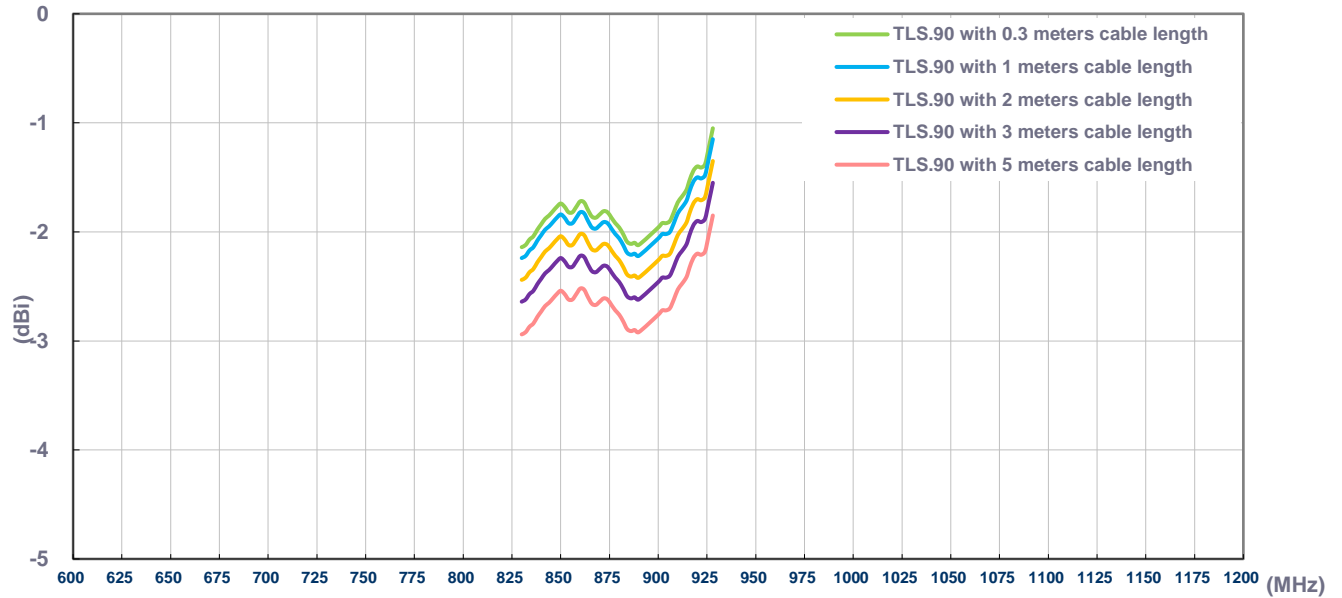

8.4 Peak Gain

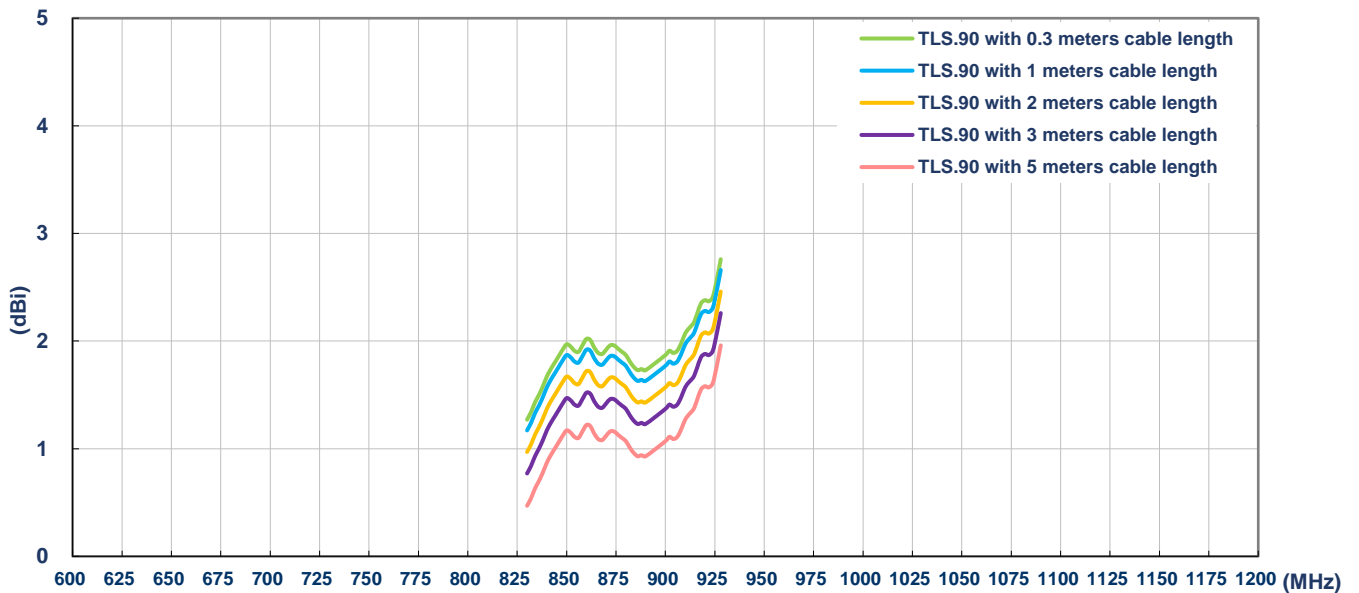

Changelog for the datasheet

SPE-19-8-096 – TLS.90.205111

Revision: A (Original First Release)	
Date:	2019-08-01
Notes:	
Author:	Jack Conroy

Previous Revisions



TAOGLAS®

www.taoglas.com



Mouser Electronics

Authorized Distributor

Click to View Pricing, Inventory, Delivery & Lifecycle Information:

[Taoglas:](#)

[TLS.90.205111](#)