



SAR Test Report

Test Report Number	STA-22021143-LC-FCC-IC-SAR
FCC ID ISED ID	2A8IPEFUSA9X 30074-EFUSA9X
Applicant Applicant Address	F&S Elektronik Systeme GmbH Untere Waldplaetze 23, Stuttgart, Baden-Wuerttemberg, Germany, 70569
Product Name Model (s) Family Model (s) Date of Receipt Date of Test Report Issue Date Test Standards	Computer On Module efusA9X efusA9Xr2 12/15/2022 01/04/2023~01/05/2023 03/07/2024 IEEE Std 1528-2013 IEC/IEEE 62209-1528: 2020 47CFR2.1093 RSS-102 Issue 5, Feb 2021 447498 D01 General RF Exposure Guidance v06 248227 D01 802 11 Wi-Fi SAR v02r02 865664 D01 SAR Measurement 100 MHz to 6 GHz v01r04
Test Result	PASS
	Issued by: Vista Compliance Laboratories 1261 Puerta Del Sol, San Clemente, CA 92673 USA www.vista-compliance.com
 <hr/>	 <hr/>
Devin Tai (Test Engineer)	David Zhang (Technical Manager)

This report is for the exclusive use of the applicant. Any copying or replication of this report to or for any other person or entity, or use of our name or trademark, is permitted only with our prior written permission. Note that the results contained in this report pertain only to the test samples identified herein, and the results relate only to the items tested and the results that were obtained in the period between the date of initial receipt of samples and the date of issue of the report. This report sets forth our findings solely with respect to the test samples identified herein. The results set forth in this report are not indicative or representative of the quality or characteristics of the lot from which a test sample was taken or any similar or identical product unless specifically and expressly noted. Our report includes all of the tests requested and the results thereof based upon the information provided to us. The applicant has 60 days from date of issuance of this report to notify us of any material error or omission. Failure to raise such issue within the prescribed time shall constitute your unqualified acceptance of the completeness of this report, the tests conducted and the correctness of the report contents. Unless specific mention, the uncertainty of measurement has been explicitly taken into account to declare the compliance or non-compliance to the specification. The report must not be used by the client to claim product certification, approval, or endorsement by any government agencies. This report is not to be reproduced by any means except in full and in any case not without the written approval of Vista Laboratories.

REVISION HISTORY

Report Number	Version	Description	Issued Date
STA-22021143-LC-FCC-IC-SAR	01	Initial report	03/07/2024

TABLE OF CONTENTS

1	TEST SUMMARY	5
2	GENERAL INFORMATION.....	6
2.1	Applicant.....	6
2.2	Product information.....	6
2.3	Test standard and method.....	7
3	MODIFICATION OF EUT / DEVIATIONS FROM STANDARDS.....	7
4	TEST CONFIGURATION AND OPERATION	7
4.1	EUT Test Configuration.....	7
4.2	Supporting Equipment	7
5	SAR INTRODUCTION	8
5.1	Introduction	8
5.2	SAR Definition.....	8
6	SAR MEASUREMENT SETUP.....	9
6.1	Dosimetric Assessment System.....	9
6.2	Measurement System.....	9
6.3	Probe.....	10
6.4	SAM Phantom.....	11
6.5	Device Holder	11
6.6	Data Evaluation	12
6.7	SAR Evaluation – Peak Spatial - Average.....	13
6.8	SAR Evaluation – Peak SAR.....	14
6.9	Device Reference Points.....	15
6.10	Test Configuration – Positioning for Cheek / Touch.....	16
6.11	Test Configuration – Positioning for Ear / 15° Tilt.....	17
6.12	Test Position – Body Worn Configurations.....	17
7	MEASUREMENT UNCERTAINTY.....	19
8	LIQUID VALIDATION	21
8.1	Liquid Validation	21
8.2	Liquid Confirmation Result.....	22
9	SYSTEM VALIDATION AND SYSTEM VERIFICATION	23
9.1	System Validation	23
9.2	System Verification.....	25
10	MEASUREMENT, EXAMINATION AND DERIVED RESULTS.....	27
10.1	Output Power Measurement Result.....	27
10.2	SAR Measurement Result.....	29

11	EUT AND TEST SETUP PHOTOS	39
12	TEST INSTRUMENT LIST	41

1 Test Summary

Test Requirement	Test Item	Test Method	Result
47CFR2.1093 RSS-102 Issue 5, Feb 2021	SAR measurement	IEEE Std 1528-2013 IEC/IEEE 62209-1528: 2020 447498 D01 General 447498 D01 General RF Exposure Guidance v06 248227 D01 802 11 Wi-Fi SAR v02r02 865664 D01 SAR Measurement 100 MHz to 6 GHz v01r04	Pass

2 General Information

2.1 Applicant

Applicant	F&S Elektronik Systeme GmbH
Applicant address	Untere Waldplaetze 23 Stuttgart Baden-Wuerttemberg Germany, 70569
Manufacturer	F&S Elektronik Systeme GmbH
Manufacturer Address	Untere Waldplaetze 23 Stuttgart Baden-Wuerttemberg Germany, 70569

2.2 Product information

Product Name	Computer On Module
Mode Name	efusA9X
Family Model Number	efusA9Xr2
Serial Number	000019034 (host Conducted sample) 000019035 (host Radiated sample)
Frequency Band	802.11b/g/n: 2412MHz to 2462MHz (11 Channels) 802.11n (40MHz): 2422MHz to 2452MHz (7 Channels)
Type of modulation	20MHz, 40MHz
Equipment Class/Category	DTS, NII
Maximum output power	See test result
Antenna Information	Chip Antenna, 2.1 dBi Peak gain for 2.4G Band
Clock Frequencies	N/A
Port/Connectors	N/A
Input Power	F&S efusA9X modules power 3.3Vdc Host product: Rechargeable Li-ion Battery (14.8 VDC)
Power Adapter Manu/Model	Host Switching Power Adapter: Model No.: UES36LCP1-190189SPA Part No.: UE210416HKSH2RM Input: 100-240VAC, 50-60Hz, 1.0A Output: 19.0VDC, 1.89A, 35.9W Host Docking Station: Atellica® VTLi SN: 000019504; 19V, 1.57A
Additional Info	This report is to document the SAR measurement result for this certified Computer On Module to be integrated into the portable device below, and support the C2PC filing. <ul style="list-style-type: none"> - Host product name: Atellica® VTLi Immunoassay Analyzer - Host product model: Atellica VTLi

2.3 Test standard and method

Test standard	47CFR 2.1093 RSS-102 Issue 5, Feb 2021
Test method	IEEE Std 1528-2013 IEC/IEEE 62209-1528: 2020 447498 D01 General RF Exposure Guidance v06 248227 D01 802 11 Wi-Fi SAR v02r02 865664 D01 SAR Measurement 100 MHz to 6 GHz v01r04

Lab performing tests	Vista Laboratories, Inc.
Lab Address	1261 Puerta Del Sol, San Clemente, CA 92673 USA
Phone Number	+1 (949) 393-1123
Website	www.vista-compliance.com

Test Condition	Temperature	Humidity	Atmospheric Pressure
SAR Testing	23.0°C	58.0%	1008 mbar

3 Modification of EUT / Deviations from Standards

The EUT is an engineering test sample loaded with RF testing firmware specifically designed to support the RF TX/RX measurement in different aspects.

4 Test Configuration and Operation

4.1 EUT Test Configuration

Host product is powered by internal battery. EUT's RF antenna port is connected to spectrum analyzer through RF test cable for output power measurement; a regular sample with original antenna was used for SAR measurement. The test software is used to set EUT to different transmission mode in terms of radio mode, test channel, data rate, etc.

4.2 Supporting Equipment

Description	Manufacturer	Model #	Serial #	Remark
AC/DC Adapter	Dell	DA130PE1-00	JU012	Provide by client
Test Laptop	Dell	Latitude E6510	3RZC1M1	Provide by client
Power Supply	UE	UES36LCP1-190189SPA	UE210416HKSH2RM	Provide by client
Charging Dock	SIEMENS Healthineers	11643523	000007001	Provide by client

5 SAR Introduction

5.1 Introduction

SAR is related to the rate at which energy is absorbed per unit mass in an object exposed to a radio field.

The SAR distribution in a biological body is complicated and is usually carried out by experimental techniques or numerical modeling. The standard recommends limits for two tiers of groups, occupational/controlled and general population/uncontrolled, based on a person's awareness and ability to exercise control over his or her exposure. In general, occupational/controlled exposure limits are higher than the limits for general population/uncontrolled.

5.2 SAR Definition

Specific Absorption Rate is defined as the time derivative (rate) of the incremental energy (dW) absorbed by (dissipated in) an incremental mass (dm) contained in a volume element (dV) of a given density (ρ).

$$SAR = \frac{d}{dt} \left(\frac{dW}{dm} \right) = \frac{d}{dt} \left(\frac{dW}{\rho dV} \right)$$

SAR is expressed in units of watts per kilogram (W/kg). SAR can be related to the electric field at a point by

$$SAR = \frac{\sigma |E|^2}{\rho}$$

Where:

σ = conductivity of the tissue (S/m)

ρ = mass density of the tissue (kg/m³)

E = RMS electric field strength (V/m)

6 SAR Measurement Setup

6.1 Dosimetric Assessment System

These measurements were performed with the automated near-field scanning system OPENSAR from SATIMO. The system is based on a high precision robot (working range: 850 mm), which positions the probes with a positional repeatability of better than ± 0.02 mm. Special E- and H-field probes have been developed for measurements close to material discontinuity, the sensors of which are directly loaded with a Schottky diode and connected via highly resistive lines to the data acquisition unit.

6.2 Measurement System



The OPENSAR system for performing compliance tests consist of the following items:

- A standard high precision 6-axis robot (KUKA) with controller and software.
- KUKA Control Panel (KCP).
- A dosimetric probe, i.e., an isotropic E-field probe optimized and calibrated for usage in tissue simulating liquid. The probe is equipped with an optical surface detector system.
- A computer operating Windows XP.
- OPENSAR software.
- Remote control with teaches pendant and additional circuitry for robot safety such as warning lamps, etc.
- The SAM phantom enabling testing left-hand right-hand and body usage.
- The Position device for handheld EUT.
- Tissue simulating liquid mixed according to the given recipes.
- System validation dipoles to validate the proper functioning of the system.

6.3 Probe

The SAR measurements were conducted with dosimetric probe (manufactured by SATIMO), designed in the classical triangular configuration and optimized for dosimetric evaluation. The probe has been calibrated according to the procedure described in SAR standard with accuracy of better than $\pm 10\%$.



It is connected to the KRC box on the robot arm and provides an automatic detection of the phantom surface. The 3D file of the phantom is included in OpenSAR software. The Video Positioning System allow the system to take the automatic reference and to move the probe safely and accurately on the phantom.



Parameter	Description
Frequency Range	100 MHz to 6 GHz
Linearity	0.25 dB (100 MHz to 6 GHz)
Directivity	0.25 dB in brain tissue (rotation around probe axis) 0.5 dB in brain tissue (rotation normal probe axis)
Dynamic	0.001W/kg to > 100W/kg
Range Linearity	0.25 dB
Surface	0.2 mm repeatability in air and liquids
Dimensions Overall length	330 mm
Tip length	16 mm
Body diameter	8 mm
Tip diameter	2.5 mm
Distance from probe tip to dipole	1 mm

E-Field Probe Calibration

Each probe is calibrated according to a dosimetric assessment procedure described in SAR standard with accuracy better than +/- 10%. The spherical isotropy was evaluated with the procedure described in SAR standard and found to be better than +/-0.25dB. The sensitivity parameters (NormX, NormY, NormZ), the diode compression parameter (DCP) and the conversion factor (ConvF) of the probe are tested.

The free space E-field from probe outputs is determined in a test chamber. This is performed in a TEM cell for frequencies below 0.8 GHz, and in a waveguide above 0.8 GHz for free space. For the free space calibration, the probe is placed in the volumetric center of the cavity and at the proper orientation with the field. E-field correlation calibration is performed in a flat phantom filled with the appropriate simulated brain tissue.

6.4 SAM Phantom

The SAR measurements were conducted with dosimetric probe (manufactured by SATIMO), designed in the classical triangular configuration and optimized for dosimetric evaluation. The probe has been calibrated according to the procedure described in SAR standard with accuracy of better than $\pm 10\%$.

The SAM Phantom SAM29 is constructed of a fiberglass shell Integrated in a wooden table. The shape of the shell is in compliance with the specification set in IEEE P1528 and CENELEC EN62209-1.

The phantom enables the dosimetric evaluation of left- and right-hand phone usage as well as body mounted usage at the flat phantom region. A cover prevents the evaporation of the liquid.

Reference markings on the Phantom allow the complete setup of all predefined phantom positions and measurement grids by manually teaching three points in the robot.

Shell Thickness: 0.2 mm

Filling Volume: Approx. 25 liters

Dimensions (H x L x W): 810 x 1000 x 500 mm

Liquid is filled to at least 15mm from the bottom of Phantom.



6.5 Device Holder

In combination with the Generic Twin Phantom V3.0, the Mounting Device enables the rotation of the mounted transmitter in spherical coordinates whereby the rotation points is the ear opening. The devices can be easily, accurately, and repeatedly positioned according to the FCC and CENELEC specifications. The device holder can be locked at different phantom locations (left head, right head, flat phantom).

Note: A simulating human hand is not used due to the complex anatomical and geometrical structure of the hand that may produce infinite number of configurations [10]. To produce the worst-case condition. (the hand absorbs antenna output power), the hand is omitted during the tests.



6.6 Data Evaluation

The OPENSAR software automatically executes the following procedure to calculate the field units from the microvolt readings at the probe connector. The parameters used in the valuation are stored in the configuration modules of the software:

Probe Parameters	- Sensitivity	Norm _i
	- Conversion factor	ConvFi
	- Diode compression	Dcpi
Device Parameter	- Frequency	f
	- Crest factor	cf
Media Parameters	- Conductivity	σ
	- Density	ρ

These parameters must be set correctly in the software. They can either be found in the component documents or are imported into the software from the configuration files issued for the OPENSAR components.

The first step of the evaluation is a linearization of the filtered input signal to account for the compression characteristics of the detector diode. The compensation depends on the input signal, the diode type and the DC-transmission factor from the diode to the evaluation electronics. If the exciting field is pulsed, the crest factor of the signal must be known to correctly compensate for peak power. The formula for each channel can be given as

$$V_i = U_i + U_i^2 \cdot \frac{cf}{dcp_i}$$

Where V_i = Compensated signal of channel i ($i = x, y, z$)
 U_i = Input signal of channel i ($i = x, y, z$)
 cf = Crest factor of exciting field (DASY parameter)
 dcp_i = Diode compression point (DASY parameter)

From the compensated input signals the primary field data for each channel can be evaluated:

$$\text{E-field probes: } E_i = \sqrt{\frac{V_i}{\text{Norm}_i \cdot \text{ConvF}}}$$

$$\text{H-field probes: } H_i = \sqrt{V_i} \cdot \frac{a_{i0} + a_{i1}f + a_{i2}f^2}{f}$$

Where V_i = Compensated signal of channel i ($i = x, y, z$)
 Norm_i = Sensor sensitivity of channel i ($i = x, y, z$)
 $\mu\text{V}/(\text{V/m})^2$ for E0field Probes
 ConvF = Sensitivity enhancement in solution
 a_{ij} = Sensor sensitivity factors for H-field probes

f = Carrier frequency (GHz)
 E_i = Electric field strength of channel i in V/m
 H_i = Magnetic field strength of channel i in A/m

The RSS value of the field components gives the total field strength (Hermitian magnitude):

$$E_{tot} = \sqrt{E_x^2 + E_y^2 + E_z^2}$$

The primary field data are used to calculate the derived field units.

$$SAR = E_{tot}^2 \cdot \frac{\sigma}{\rho \cdot 1000}$$

where SAR = local specific absorption rate in mW/g
 E_{tot} = total field strength in V/m
 σ = conductivity in [mho/m] or [siemens/m]
 ρ = equivalent tissue density in g/cm³

Note that the density is normally set to 1 (or 1.06), to account for actual brain density rather than the density of the simulation liquid.

The power flow density is calculated assuming the excitation field as a free space field.

$$P_{pwe} = \frac{E_{tot}^2}{3770} \quad \text{or} \quad P_{pwe} = H_{tot}^2 \cdot 37.7$$

where P_{pwe} = Equivalent power density of a plane wave in mW/cm²
 E_{tot} = total electric field strength in V/m
 H_{tot} = total magnetic field strength in A/m

6.7 SAR Evaluation – Peak Spatial - Average

The procedure for assessing the peak spatial-average SAR value consists of the following steps

- Power Reference Measurement**
 The reference and drift jobs are useful jobs for monitoring the power drift of the device under test in the batch process. Both jobs measure the field at a specified reference position, at a selectable distance from the phantom surface. The reference position can be either the selected section's grid reference point or a user point in this section. The reference job projects the selected point onto the phantom surface, orients the probe perpendicularly to the surface, and approaches the surface using the selected detection method.
- Area Scan**
 The area scan is used as a fast scan in two dimensions to find the area of high field values, before doing a finer measurement around the hot spot. The sophisticated interpolation routines implemented in OPENSAR software can find the maximum locations even in relatively coarse grids. The scan area is defined by an editable grid. This grid is anchored at the grid reference point of the selected section in the phantom. When the area scan's property sheet is brought-up, grid was at to 15 mm by 15 mm and can be edited by a user.
- Zoom Scan**
 Zoom scans are used to assess the peak spatial SAR values within a cubic averaging volume containing 1 g and 10 g of simulated tissue. The default zoom scan measures 5 x 5 x 7 points within a cube whose base faces are centered on the maximum found in a preceding area scan job within the same procedure. If the preceding Area Scan job indicates more than one maximum, the number of Zoom Scans has to be enlarged accordingly (The default number inserted is 1).
- Power Drift measurement**
 The drift job measures the field at the same location as the most recent reference job within the same procedure, and with the same settings. The drift measurement gives the field difference in dB from the reading conducted within the last reference measurement. Several drift measurements are possible for one reference measurement. This allows a user to monitor the power drift of the device under test within a batch process. In the properties of the Drift job, the user can specify a limit for the drift and have OPENSAR software stop the measurements if this limit is exceeded.

6.8 SAR Evaluation – Peak SAR

The SAR measurements were conducted with dosimetric probe (manufactured by SATIMO), designed in the classical triangular configuration and optimized for dosimetric evaluation. The probe has been calibrated according to the procedure described in SAR standard with accuracy of better than $\pm 10\%$.

The procedure for spatial peak SAR evaluation has been implemented according to the IEEE1529 standard. It can be conducted for 1 g and 10 g. The OPENSAR system allows evaluations that combine measured data and robot positions, such as:

- Maximum search
- Extrapolation
- Boundary correction
- Peak search for averaged SAR

During a maximum search, global and local maximum searches are automatically performed in 2-D after each Area Scan measurement with at least 6 measurement points. It is based on the evaluation of the local SAR gradient calculated by the Quadratic Shepard's method. The algorithm will find the global maximum and all local maxima within -2 dB of the global maxima for all SAR distributions.

Extrapolation

Extrapolation routines are used to obtain SAR values between the lowest measurement points and the inner phantom surface. The extrapolation distance is determined by the surface detection distance and the probe sensor offset. Several measurements at different distances are necessary for the extrapolation.

They are used in the Cube Scan to obtain SAR values between the lowest measurement points and the inner phantom surface. The routine uses the fourth order least square polynomial method for extrapolation. For a grid using 5x5x7 measurement points with 5mm resolution amounting to 343 measurement points, the uncertainty of the extrapolation routines is less than 1% for 1 g and 10 g cubes.

6.9 Device Reference Points

Definition of Reference Points

Ear Reference Point

Figure 6.2 shows the front, back and side views of the SAM Phantom. The point “M” is the reference point for the center of the mouth, “LE” is the left ear reference point (ERP), and “RE” is the right ERP. The ERPs are 15mm posterior to the entrance to the ear canal (EEC) along the B-M line (Back-Mouth), as shown in Figure 6.1. The plane passing through the two ear canals and M is defined as the Reference Plane. The line N-F (Neck-Front) is perpendicular to the reference plane and passing through the RE (or LE) is called the Reference Pivoting Line (see Figure 6.1). Line B-M is perpendicular to the N-F line. Both N-F and B-M lines are marked on the external phantom shell to facilitate handset positioning [5].

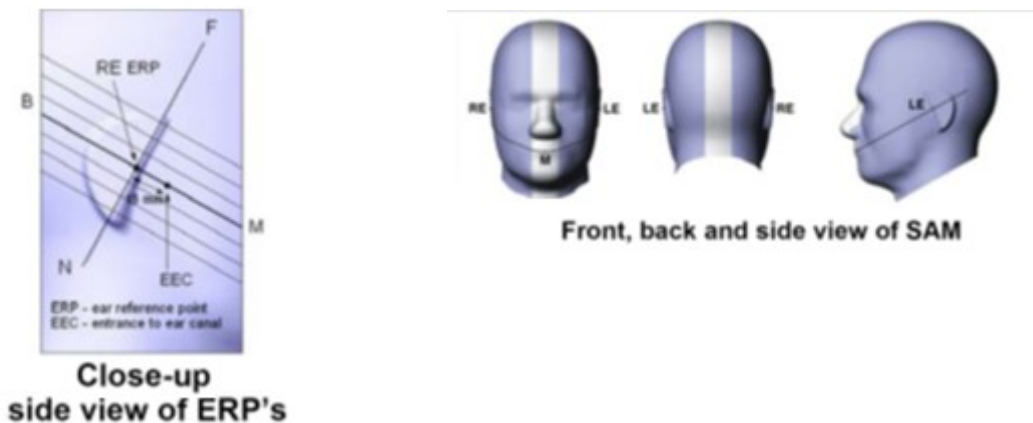

Two imaginary lines on the device need to be established: the vertical centerline and the horizontal line. The test device is placed in a normal operating position with the “test device reference point” located along the “vertical centerline” on the front of the device aligned to the “ear reference point” (See Fig. 6.3). The “test device reference point” is then located at the same level as the center of the ear reference point. The test device is positioned so that the “vertical centerline” is bisecting the front surface of the device at its top and bottom edges, positioning the “ear reference point” on the outer surface of both the left and right head phantoms on the ear reference point.

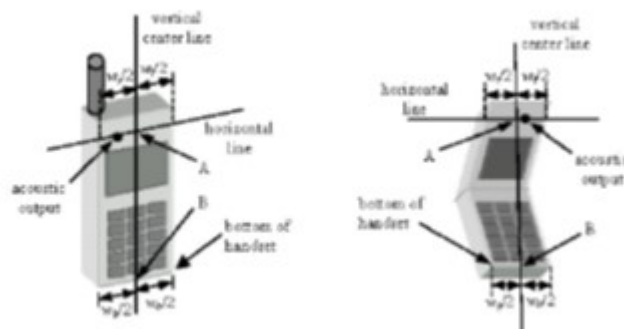

Handset Vertical Center & Horizontal Line Reference Points

6.10 Test Configuration – Positioning for Cheek / Touch

1. Position the device close to the surface of the phantom such that point A is on the (virtual) extension of the line passing through points RE and LE on the phantom (see Figure below), such that the plane defined by the vertical center line and the horizontal line of the device is approximately parallel to the sagittal plane of the phantom



Front, Side and Top View of Cheek/Touch Position

2. Translate the device towards the phantom along the line passing through RE and LE until the device touches the ear.
3. While maintaining the device in this plane, rotate it around the LE-RE line until the vertical centerline is in the plane normal to MB-NF including the line MB (called the reference plane).
4. Rotate the device around the vertical centerline until the device (horizontal line) is symmetrical with respect to the line NF.
5. While maintaining the vertical centerline in the reference plane, keeping point A on the line passing through RE and LE and maintaining the device contact with the ear, rotate the device about the line NF until any point on the device is in contact with a phantom point below the ear (cheek). See Figure below.

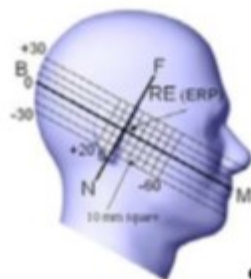

Side view w/ relevant markings

6.11 Test Configuration – Positioning for Ear / 15° Tilt

With the test device aligned in the Cheek/Touch Position”:

1. While maintaining the orientation of the device, retracted the device parallel to the reference plane far enough to enable a rotation of the device by 15 degrees.
2. Rotate the device around the horizontal line by 15 degrees.
3. While maintaining the orientation of the device, move the device parallel to the reference plane until any part of the device touches the head. (In this position, point A is located on the line RE-LE). The tilted position is obtained when the contact is on the pinna. If the contact is at any location other than the pinna, the angle of the device shall be reduced. The tilted position is obtained when any part of the device is in contact with the ear as well as a second part of the device is in contact with the head (see Figure below).



Front, Side and Top View of Ear/15° Tilt Position

6.12 Test Position – Body Worn Configurations

Body-worn operating configurations are tested with the accessories attached to the device and positioned against a flat phantom in a normal use configuration. A device with a headset output is tested with a headset connected to the device. Body dielectric parameters are used.

Accessories for Body-worn operation configurations are divided into two categories: those that do not contain metallic components and those that do contain metallic components. When multiple accessories that do not contain metallic components are supplied with the device, the device is tested with only the accessory that dictates the closest spacing to the body. Then, when multiple accessories that contain metallic components are supplied with the device, the device is tested with each accessory that contains a unique metallic component. If multiple accessories share an identical metallic component (i.e. the same metallic belt-clip used with different holsters with no other metallic components) only the accessory that dictates the closest spacing to the body is tested.

Body-worn accessories may not always be supplied or available as options for some devices intended to be authorized for body-worn use. In this case, a test configuration where a separation distance between the back of the device and the flat phantom is used. All test position spacing are documented.

Transmitters that are designed to operate in front of a person's face, as in push-to-talk configurations, are tested for SAR compliance with the front of the device positioned to face the flat phantom. For devices that are carried next to the body such as a shoulder, waist or chest-worn transmitters, SAR compliance is tested with the accessory(ies), including headsets

and microphones, attached to the device and positioned against a flat phantom in a normal use configuration.

In all cases SAR measurements are performed to investigate the worst-case positioning. Worst-case positioning is then documented and used to perform Body SAR testing.

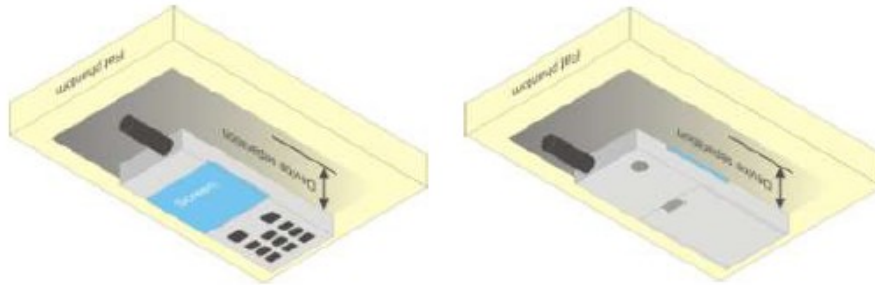

7 Measurement Uncertainty

The component of uncertainty may generally be categorized according to the methods used to evaluate them. The evaluation of uncertainty by the statistical analysis of a series of observations is termed a Type A evaluation of uncertainty. The evaluation of uncertainty by means other than the statistical analysis of a series of observation is termed a Type B evaluation of uncertainty. Each component of uncertainty, however evaluated, is represented by an estimated standard deviation, termed standard uncertainty, which is determined by the positive square root of the estimated variant

A Type A evaluation of standard uncertainty may be based on any valid statistical method for treating data. This includes calculating the standard deviation of the mean of a series of independent observations; using the method of least squares to fit a curve to the data in order to estimate the parameter of the curve and their standard deviations; or carrying out an analysis of variance in order to identify and quantify random effects in certain kinds of measurement.

A type B evaluation of standard uncertainty is typically based on scientific judgment using all of the relevant information available. These may include previous measurement data, experience and specification, data provided in calibration reports and uncertainties assigned to reference data taken from handbooks. Broadly speaking, the uncertainty is either obtained from an outdoor source or obtained from an assumed distribution, such as the normal distribution, rectangular or triangular distributions indicated in Table below:

<i>Uncertainty Distribution</i>	<i>Normal</i>	<i>Rectangle</i>	<i>Triangular</i>	<i>U Shape</i>
<i>Multi-plying Factor^(a)</i>	$1/k^{(b)}$	$1/\sqrt{3}$	$1/\sqrt{6}$	$1/\sqrt{2}$

(a) standard uncertainty is determined as the product of the multiplying factor and the estimated range of variations in the measured quantity

(b) κ is the coverage factor

Standard Uncertainty for Assumed Distribution

The combined standard uncertainty of the measurement result represents the estimated standard deviation of the result. It is obtained by combining the individual standard uncertainties of both Type A and Type B -sum-by taking the positive square root of the estimated variances.

Expanded uncertainty is a measure of uncertainty that defines an interval about the measurement result within which the measured value is confidently believed to lie. It is obtained by multiplying the combined standard uncertainty by a coverage factor. Typically, the coverage factor ranges from 2 to 3. Using a coverage factor allows the true value of a measured quantity to be specified with a defined probability within the specified uncertainty range. For purpose of this document, a coverage factor two is used, which corresponds to confidence interval of about 95 %.

The COMOSAR Uncertainty Budget is show in below table:

Uncertainty Budget of COMOSAR for frequency range 300 MHz to 6 GHz

Uncertainty Component	Tolerances %	Probability Distribution	Divisor	Ci (1g)	Ci (10g)	Uncertainty Y 1g(%)	Uncertainty Y 10g(%)
Measurement System Related							
Probe Calibration	6	N	1	1	1	6	6
Axial Isotropy	3	R	$\sqrt{3}$	$\sqrt{1-C_p}$	$\sqrt{1-C_p}$	1.22474	1.22474
Hemispherical Isotropy	4	R	$\sqrt{3}$	$\sqrt{C_p}$	$\sqrt{C_p}$	1.63299	1.63299
Boundary Effect	1	R	$\sqrt{3}$	1	1	0.57735	0.57735
Linearity	5	R	$\sqrt{3}$	1	1	2.88675	2.88675
System Detection Limits	1	R	$\sqrt{3}$	1	1	0.57735	0.57735
Readout Electronics	0.5	N	1	1	1	0.5	0.5
Response Time	0.2	R	$\sqrt{3}$	1	1	0.11547	0.11547
Integration Time	2	R	$\sqrt{3}$	1	1	1.1547	1.1547
RF Ambient Conditions	3	R	$\sqrt{3}$	1	1	1.73205	1.73205
Probe Positioner Mechanical Tolerances	2	R	$\sqrt{3}$	1	1	1.1547	1.1547
Probe Positioning with respect to Phantom Shell	1	R	$\sqrt{3}$	1	1	0.57735	0.57735
Extrapolation, Interpolation and integration Algorithms for Max. SAR Evaluation.	1.5	R	$\sqrt{3}$	1	1	0.86603	0.86603
Test Sample Related							
Test Sample Positioning	1.5	N	1	1	1	1.5	1.5
Device Holder Uncertainty	5	N	1	1	1	5	5
Output Power Variation – SAR Drift measurement	3	R	$\sqrt{3}$	1	1	1.73205	1.73205
Phantom and Tissue Parameters Related							
Phantom Uncertainty (Shape and thickness Tolerances)	4	R	$\sqrt{3}$	1	1	2.3094	2.394
Liquid Conductivity – deviation from target value	5	R	$\sqrt{3}$	0.64	0.43	1.84752	1.2413
Liquid Conductivity – Measurement Uncertainty	2.5	N	1	0.64	0.43	1.6	1.075
Liquid Permittivity – deviation from target value	3	R	$\sqrt{3}$	0.6	0.49	1.03923	0.8487
Liquid Permittivity – Measurement Uncertainty	2.5	N	1	0.6	0.49	1.5	1.225
Combined Standard Uncertainty						9.66051 %	9.52428 %
Expanded Standard Uncertainty (K=2 , confidence 95%)						18.9346 %	18.6676 %

8 Liquid Validation

8.1 Liquid Validation

The dielectric parameters were checked prior to assessment using the HP85070C dielectric probe kit. The dielectric parameters measured are reported in each correspondent section.

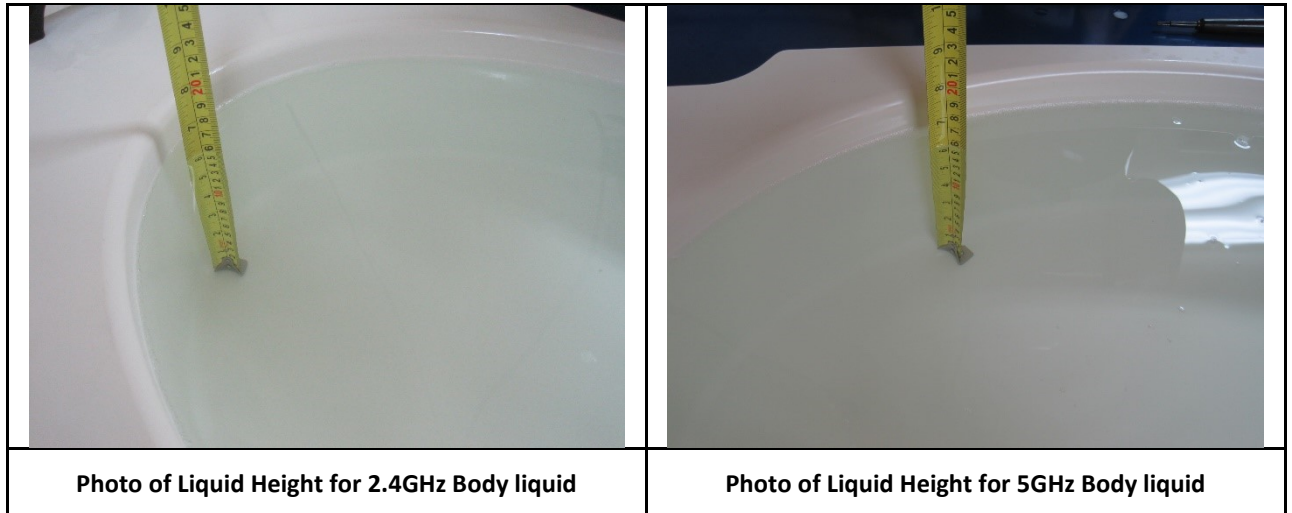

IEEE SCC-34/SC-2 P1528 recommended Tissue Dielectric Parameters

The head tissue dielectric parameters recommended by the IEEE SCC-34/SC-2 in P1528 have been incorporated in the following table. These head parameters are derived from planar layer models simulating the highest expected SAR for the dielectric properties and tissue thickness variations in a human head. Other head and body tissue parameters that have not been specified in P1528 are derived from the tissue dielectric parameters computed from the 4-Cole-Cole equations and extrapolated according to the head parameters specified in P1528

Target Frequency MHz	Head		Body	
	ϵ_r	σ (S/m)	ϵ_r	σ (S/m)
150	52.3	0.76	61.9	0.80
300	45.3	0.87	58.2	0.92
450	43.5	0.87	56.7	0.94
835	41.5	0.90	55.2	0.97
900	41.5	0.97	55.0	1.05
915	41.5	0.98	55.0	1.06
1450	40.5	1.20	54.0	1.30
1610	40.3	1.29	53.8	1.40
1800-2000	40.0	1.40	53.3	1.52
2450	39.2	1.80	52.7	1.95
3000	38.5	2.40	52.0	2.73
5800	35.3	5.27	48.2	6.00

Note: ϵ_r = relative permittivity, σ = conductivity and $\rho = 1000 \text{ kg/m}^3$

8.2 Liquid Confirmation Result

Measuring results for head tissue simulating liquid are shown as below.

Measure Date	Frequency (MHz)	Target Permittivity	Target Conductivity	Measured Permittivity	Measured Conductivity	Permittivity Deviation	Conductivity Deviation	Limit (%)
01/04/2023	2450	39.20	1.80	39.21	1.79	0.03	-0.56	10
01/05/2023	5200	36.00	4.66	35.24	4.73	-2.11	1.50	10
01/05/2023	5800	35.30	5.27	35.35	5.33	0.14	1.14	10
Remark	Temperature: 22 ~23 oC Relative Humidity: 58% Atmospheric Pressure: 1008 mbar							

Note:

1. The dielectric properties of the tissue-equivalent liquids shall be measured within 24 h before the SAR measurements.
2. The measured conductivity and relative permittivity shall be within 10 % of the target values.

9 System Validation and System Verification

9.1 System Validation

The dielectric parameters were checked prior to assessment using the HP85070C dielectric probe kit. The dielectric parameters measured are reported in each correspondent section.

The system validation procedure evaluates the system against reference SAR values and the performance of the probe, readout electronics, and software. The test setup utilizes a flat phantom and a reference dipole.

Thus, the system validation process does not include data scatter due to the use of anthropomorphic phantoms or uncertainty due to handset positioning variability. System validation should be performed annually, or when a new system is put into operation, or whenever modifications have been made to the system, such as a new software release, different readout electronics or different types of probes. The probe used in the test system to be validated should be properly calibrated.

System validation provides a means of system-level validation. The test system utilizes a flat phantom and a reference dipole. Thus, system validation verifies the system accuracy against its specifications but does not include the uncertainty due to the use of anthropomorphic phantoms, nor does it include the uncertainty due to handset positioning variability. This test is performed annually (e.g., after probe calibration), before measurements related to inter laboratory comparison and every time modifications have been made to the system, such as a new software release, different readout electronics, and for different types of probes.

System Validation procedure is at below,

- a) **SAR evaluation:** A complete 1 g or 10 g averaged SAR measurement is performed. The reference dipole input power is adjusted to produce a 1 g averaged SAR value falling in the range of 0.4–10 W/kg. The 1 g or 10 g averaged SAR is measured at frequencies in reference table within the range to be used in compliance tests. The results are normalized to 1 W forward input power and compared with the reference SAR values shown in reference value. The differences from the reference values should be less than the tolerance specified for the SAR measurement system by the manufacturer or designer, i.e., within the expanded uncertainty for the system validation.
- b) **Extrapolation routine:** Local SAR values are measured along a vertical axis directly above the reference dipole feed-point using the same test grid-point spacing as used for handset SAR evaluations. This measurement is repeated along another vertical axis with a 2 cm transverse offset from the reference dipole feed-point. SAR values at the phantom surface are extrapolated and compared with the numerical values given in reference table. The difference from the reference values should be less than the tolerance specified for the SAR measurement system by the manufacturer or designer, i.e., within the expanded uncertainty for system validation.
- c) **Probe linearity:** The measurement in step a) is repeated using different reference dipole input power levels. The power levels are selected for each frequency to produce 1 g averaged SAR values of approximately 10 W/kg, 2 W/kg, and 0.4 W/kg. The measured SAR values are normalized to 1 W forward input power and compared with the 1 W normalized value from step a). The difference between these values should be less than the tolerance specified for the SAR measurement system by the manufacturer or designer, i.e., within the expanded uncertainty for the linearity component.

- d) **Modulation response:** The measurements in step a) are repeated with pulse-modulated signals having a duty factor of 0.1 and pulse repetition rate of 10 Hz. The power is adjusted to produce a 1 g-averaged SAR of approximately 8 W/kg with the pulse modulated signal (corresponding to a peak spatial-average SAR of approximately 80 W/kg). The measured SAR values are normalized to 1 W forward input power and duty factor of 1, and compared with the 1 W normalized values from step a). The difference between these values should be less than the tolerance specified for the SAR measurement system by the manufacturer or designer, i.e., within the expanded uncertainty for system validation.
- e) **System offset:** The measurements in step a) are repeated with a reference dipole input forward power that produces a 1 g or 10 g averaged SAR of approximately 0.05 W/kg. The measured SAR values are normalized to 1 W forward input power and compared with the 1 W normalized values from step a). The difference between these values should be less than the tolerance specified for the SAR measurement system by the manufacturer or designer, i.e., within the expanded uncertainty for system validation.
- f) **Probe axial isotropy:** The center point of the probe's sensors is placed directly above the reference dipole center at a measurement distance of approximately 5–10 mm from the phantom inner surface. The probe (or reference dipole, if precise rotations are supported by the dipole fixture) is rotated around its axis $\pm 180^\circ$ in steps no larger than 15° . The maximum and minimum SAR readings are recorded. The difference between these values should be less than the tolerance specified for the SAR measurement system by the manufacturer or designer, i.e., within the expanded uncertainty for the axial isotropy component.

9.2 System Verification

9.2.1 Requirement(s):

The system performance check verifies that the system operates within its specifications. System and operator errors can be detected and corrected. It is recommended that the system performance check be performed prior to any usage of the system in order to guarantee reproducible results. The system performance check uses normal SAR measurements in a simplified setup with a well characterized source. This setup was selected to give a high sensitivity to all parameters that might fail or vary over time. The system check does not intend to replace the calibration of the components, but indicates situations where the system uncertainty is exceeded due to drift or failure.

In the simplified setup for system evaluation, the DUT is replaced by a calibrated dipole and the power source is replaced by a continuous wave that comes from a signal generator. The calibrated dipole must be placed beneath the flat phantom section of the SAM twin phantom with the correct distance holder. The distance holder should touch the phantom surface with a light pressure at the reference marking and be oriented parallel to the long side of the phantom. The equipment setup is shown below:

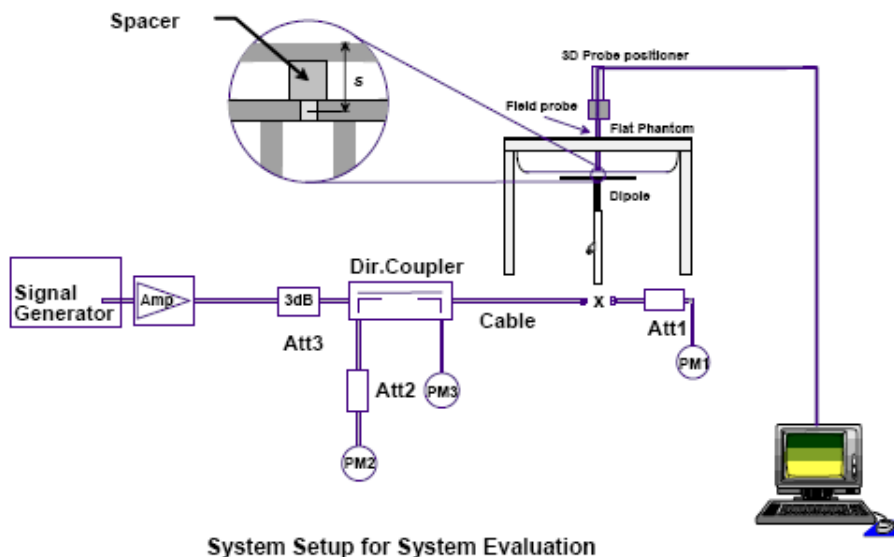

Note: Equipment description

1. Signal Generator
2. Amplifier
3. Directional Coupler
4. Power Meter
5. Calibrated Dipole

9.2.2 System Verification Results

Measure Date	Temp (oC)	Humidity (%)	Frequency (MHz)	Phantom /Liquid	Target SAR1g (W/kg)	Input Power (dBm)	Measured SAR1g (W/kg)	1W Normalized SAR1g (W/kg)	Deviation (%)
01/04/2023	22	58	2450	Head	52.4	15	1.65	52.18	-0.42
01/05/2023	22	58	5200	Head	159.0	15	4.75	150.21	-5.53
01/05/2023	22	58	5800	Head	181.2	15	5.63	178.04	-1.75

Note:

1. The system validation difference from the target value should be within $\pm 10\%$.
2. The system checks shall be performed daily or before every SAR measurement.

10 Measurement, Examination and Derived Results

10.1 Output Power Measurement Result

2.4GHz band

Mode	Channel	Frequency (MHz)	Data rate	Measured Output Power (dBm)	Tune-Up Power (dBm)
802.11b	1	2412	1Mbps	16.312	17.0
	6	2437	1Mbps	16.096	17.0
	11	2462	1Mbps	16.751	17.0
802.11g	1	2412	6Mbps	15.221	16.0
	6	2437	6Mbps	15.549	16.0
	11	2462	6Mbps	15.853	16.0
802.11n	1	2412	MCS0	15.110	16.0
	6	2437	MCS0	15.338	16.0
	11	2462	MCS0	15.787	16.0
802.11n40	3	2422	MCS0	14.708	15.0
	6	2437	MCS0	14.698	15.0
	9	2452	MCS0	14.782	15.0

5 GHz band

Output power measurement result

U-NII-1 Band

Mode	Channel	Frequency (MHz)	Data rate	Measured Output Power (dBm)	Tune-Up Power (dBm)
802.11a	36	5180	6Mbps	13.81	14.0
	40	5200	6Mbps	14.03	15.0
	48	5240	6Mbps	13.97	14.0
802.11n	36	5180	HT20-MCS0	13.84	14.0
	40	5200	HT20-MCS0	13.87	14.0
	48	5240	HT20-MCS0	13.96	14.0
802.11n40	38	5190	HT40-MCS0	12.73	13.0
	46	5230	HT40-MCS0	12.76	13.0
802.11ac80	42	5210	VHT80-MCS0	12.11	13.0

U-NII-2A Band

Mode	Channel	Frequency (MHz)	Data rate	Measured Output Power (dBm)	Tune-Up Power (dBm)
802.11a	52	5260	6Mbps	12.24	13.0
	56	5280	6Mbps	12.55	13.0
	64	5320	6Mbps	12.76	13.0
802.11n	52	5260	HT20-MCS0	12.08	13.0
	56	5280	HT20-MCS0	12.35	13.0
	64	5320	HT20-MCS0	12.39	13.0
802.11n40	54	5270	HT40-MCS0	12.72	13.0
	62	5310	HT40-MCS0	13.13	14.0
802.11ac80	58	5290	VHT80-MCS0	12.44	13.0

U-NII-2C Band

Mode	Channel	Frequency (MHz)	Data rate	Measured Output Power (dBm)	Tune-Up Power (dBm)
802.11a	100	5500	6Mbps	13.67	14.0
	116	5580	6Mbps	12.51	13.0
	140	5700	6Mbps	11.70	12.0
802.11n	100	5500	HT20-MCS0	13.59	14.0
	116	5580	HT20-MCS0	12.26	13.0
	140	5700	HT20-MCS0	11.68	12.0
802.11n40	102	5510	HT40-MCS0	14.13	15.0
	118	5590	HT40-MCS0	13.22	14.0
	134	5670	HT40-MCS0	12.53	13.0
802.11ac80	106	5530	HT40-MCS0	13.72	14.0
	122	5610	VHT80-MCS0	12.69	13.0

U-NII-3 Band

Mode	Channel	Frequency (MHz)	Data rate	Measured Output Power (dBm)	Tune-Up Power (dBm)
802.11a	149	5745	6Mbps	13.14	14.0
	157	5785	6Mbps	12.87	13.0
	165	5825	6Mbps	13.13	14.0
802.11n	149	5745	HT20-MCS0	13.13	14.0
	157	5785	HT20-MCS0	12.74	13.0
	165	5825	HT20-MCS0	13.05	14.0
802.11n40	151	5755	HT40-MCS0	13.65	14.0
	159	5795	HT40-MCS0	13.75	14.0
802.11ac80	155	5775	HT40-MCS0	13.13	14.0

10.2 SAR Measurement Result

10.2.1 Standalone SAR Test Result

Mode	Freq (MHz)	Position	Tune-Up Power (dBm)	Measured Output Power (dBm)	Raw SAR 1g(W/kg)	Power Drift (%)	Scaled SAR (W/kg)	1g SAR Limit (W/kg)
802.11b	2462	Front	17	16.751	0.0231	-0.79	0.0245	1.6
	2462	Left	17	16.751	0.0753	1.17	0.0797	1.6
802.11a	5200	Front	15	14.03	0.0852	-1.78	0.1065	1.6
	5200	Left	15	14.03	0.2507	-0.72	0.3134	1.6

Note:

1. Separation distance to phantom is 0 cm from all sides (direct touch position)
2. Only two sides that the antenna is close to the enclosure surface were tested. See the EUT external photos for reference.
 - a. EUT-External-Front side
 - b. EUT-External-Left Side

Test reduction table for 2.4GHz Band

Mode	Freq (MHz)	Position	Tested/Reduced
802.11b	2462	Front	Tested
802.11b	Remaining Channels	Front	Reduced (1)
802.11b	Remaining Channels	Front	Reduced (1)
802.11b	2462	Left	Tested
802.11b	Remaining Channels	Left	Reduced (1)
802.11g	All Channels	Front	Reduced (2)
802.11g	All Channels	Left	Reduced (2)
802.11n-20MHz	All Channels	Front	Reduced (2)
802.11n-20MHz	All Channels	Left	Reduced (2)
802.11n-40MHz	All Channels	Front	Reduced (2)
802.11n-40MHz	All Channels	Left	Reduced (2)

Note:

- (1) According to KDB 248227 Section 5.2.1, when the reported SAR of the highest measured maximum output power channel for the exposure configuration is ≤ 0.8 W/kg, no further SAR testing is required for 802.11b DSSS in that exposure configuration. When the reported SAR is > 0.8 W/kg, SAR is required for that exposure configuration using the next highest measured output power channel. When any reported SAR is > 1.2 W/kg, SAR is required for the third channel, i.e., all channels require testing.
- (2) According to 248227 Section 5.2.2, SAR is not required for the following 2.4 GHz OFDM condition, when the highest reported SAR for DSSS is adjusted by the ratio of OFDM to DSSS specified maximum output power and the adjusted SAR is ≤ 1.2 W/kg.

Test reduction table for 5 GHz band

Mode	Freq (MHz)	Position	Tested/Reduced
802.11a	5200	Front	Tested
802.11a	Remaining Channels	Front	Reduced (1)
802.11a	5200	Left	Tested
802.11a	Remaining Channels	Left	Reduced (1)
802.11n-20MHz	All Channels	Front	Reduced (2)(3)(4)
802.11n-20MHz	All Channels	Left	Reduced (2)(3)(4)
802.11n-40MHz	All Channels	Front	Reduced (2)(3)(4)
802.11n-40MHz	All Channels	Left	Reduced (2)(3)(4)
802.11ac-80MHz	All Channels	Front	Reduced (2)(3)(4)
802.11ac-80MHz	All Channels	Left	Reduced (2)(3)(4)

Note:

- (1) According to KDB 248227 Section 5.3.1, U-NII-1 and U-NII-2A bands, When different maximum output power is specified for the bands, begin SAR measurement in the band with higher specified maximum output power. The highest reported SAR for the tested configuration is adjusted by the ratio of lower to higher specified maximum output power for the two bands. When the adjusted SAR is ≤ 1.2 W/kg, SAR is not required for the band with lower maximum output power in that test configuration.
- (2) According to KDB 248227 Section 5.3.3, OFDM when the reported SAR of the initial test configuration is > 0.8 W/kg, SAR measurement is required for subsequent next highest measured output power channel(s) in the initial test configuration until reported SAR is ≤ 1.2 W/kg or all required channels are tested.
- (3) According to KDB 248227 Section 5.3.4 (b), when the highest reported SAR for the initial test configuration, according to the initial test position or fixed exposure position requirements, is adjusted by the ratio of the subsequent test configuration to initial test configuration specified maximum output power and the adjusted SAR is ≤ 1.2 W/kg, SAR is not required for that subsequent test configuration.
- (4) According to KDB 447498 Section 4.4.1, testing of other required channels within the operating mode of a frequency band is not required when the reported 1-g or 10-g SAR ≤ 0.8 W/kg or 2.0 W/kg, for 1-g or 10-g respectively, when the transmission band is ≤ 100 MHz.

10.2.2 Antenna Location & Separation distance

Antenna Location & Separation distance

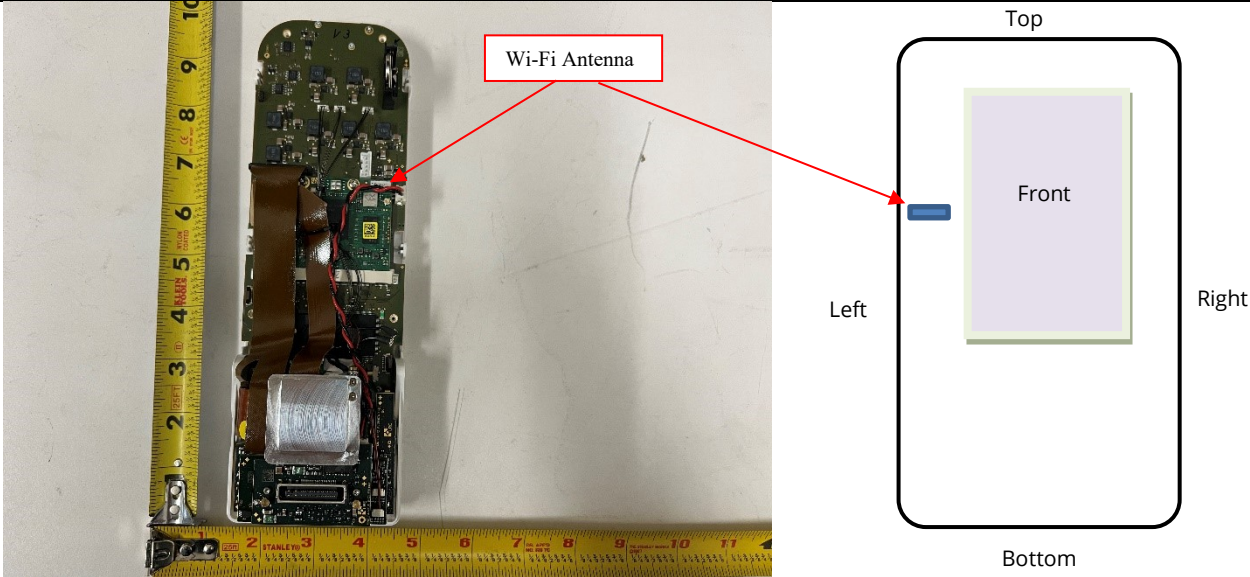
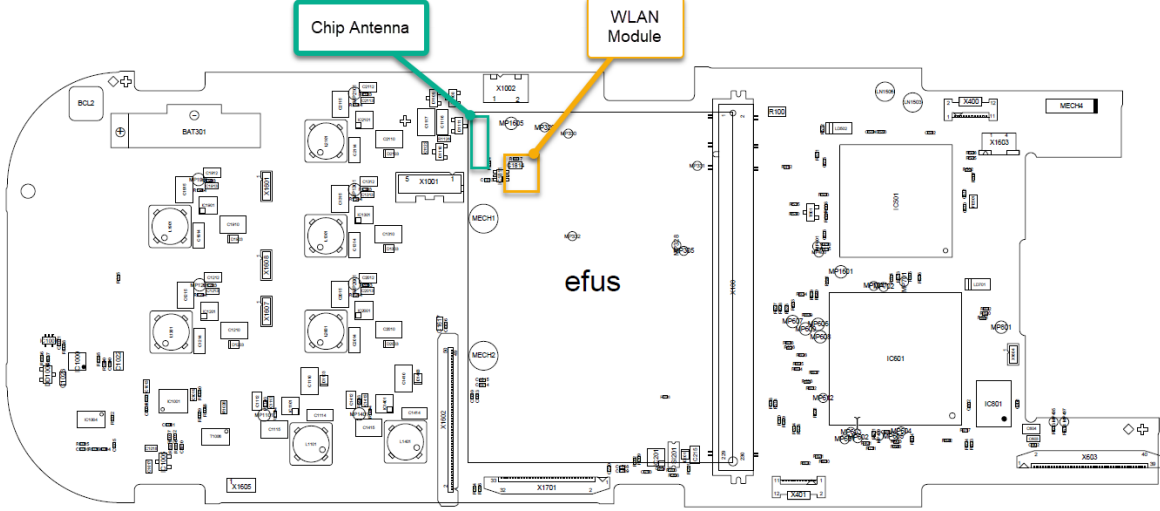
The separation distance for antenna to edge:

Antenna	To Top Side (mm)	To Bottom Side (mm)	To Left Side (mm)	To Right Side (mm)	To Front Side (mm)	To Rear Side (mm)
WLAN	95	155	15	70	20	30

Note: Only two sides that the antenna is close to the enclosure surface were tested. See the EUT external photos for reference.

- EUT-External-Front Side
- EUT-External-Left Side

10.2.3 SAR Test Plots of System verification

Test specification:	System Verification			Result:	Pass
Environ Conditions:	Temp(oC):	22			
	Humidity (%):	58			
	Atmospheric(mPa):	1008			
Mains Power:	N/A				
Test Date:	01/04/2023				
Tested by:	Devin Tai				
Remarks:	N/A				

Frequency (MHz)	2450.000000
Relative permittivity (real part)	39.214
Conductivity (S/m)	1.792
Probe SN	2715_EPGO259
Area Scan Resolution	8 mm
Zoom Scan Resolution	dx=8mm, dy=8mm, dz=5mm
Zoom Scan Size	32x32x34 mm
Measurement Drifts (%)	-0.110
Highest Extrapolated SAR (W/Kg)	2.5602
SAR 1g (W/Kg)	1.6520
Peak SAR Location	0mm(x),-6mm(y),4mm(z)

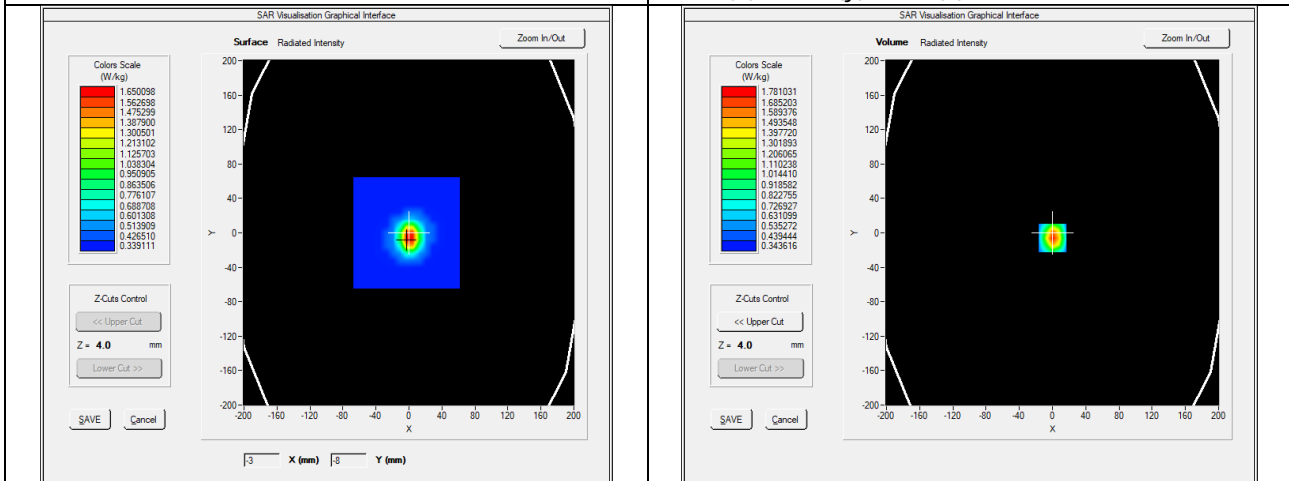

SURFACE SAR

VOLUME SAR

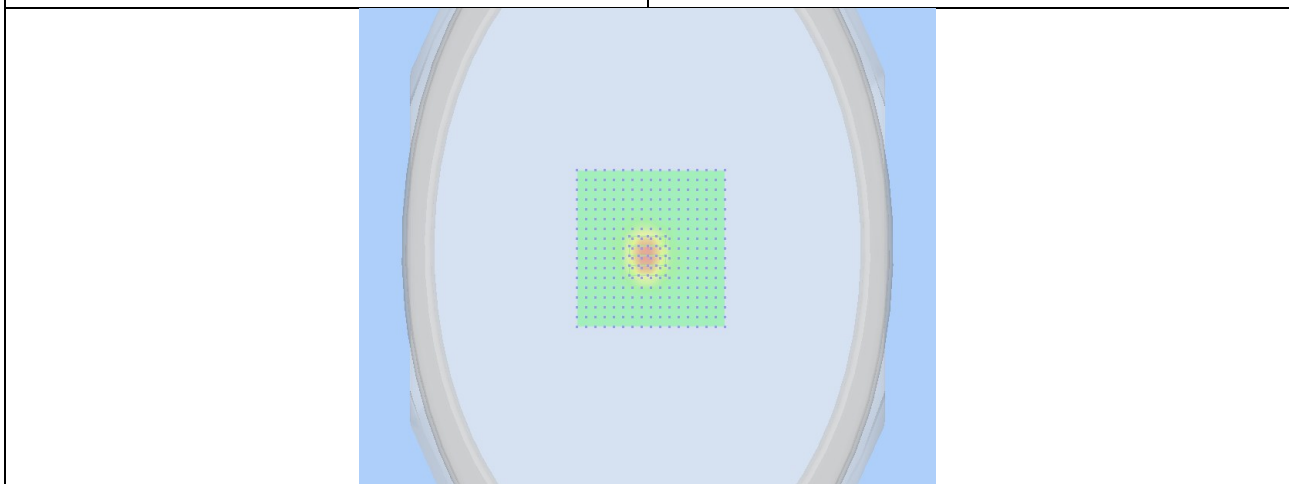

3D View Plot

Test specification:	System Verification			Result:	Pass
Environ Conditions:	Temp(oC):	22			
	Humidity (%):	58			
	Atmospheric(mPa):	1008			
Mains Power:	N/A				
Test Date:	01/05/2023				
Tested by:	Devin Tai				
Remarks:	N/A				

Frequency (MHz)	5200.000000
Relative permittivity (real part)	35.243
Conductivity (S/m)	4.732
Probe SN	2715_EPGO259
Area Scan Resolution	8 mm
Zoom Scan Resolution	dx=8mm, dy=8mm, dz=5mm
Zoom Scan Size	32x32x34 mm
Measurement Drifts (%)	0.132
Highest Extrapolated SAR (W/Kg)	5.514
SAR 1g (W/Kg)	4.748
Peak SAR Location	6mm(x),-6mm(y),4mm(z)

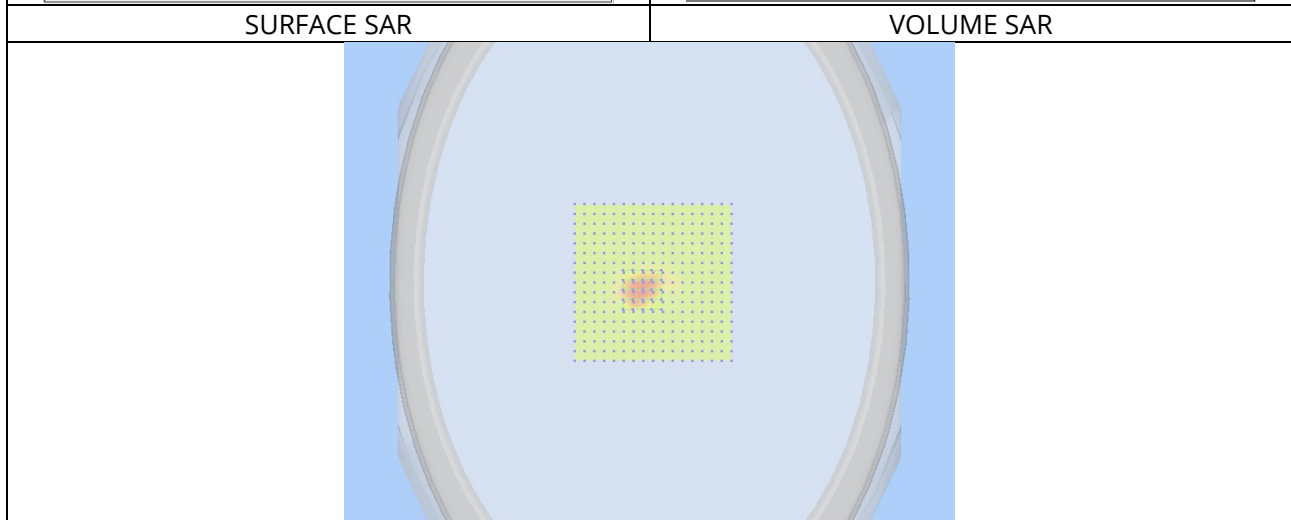
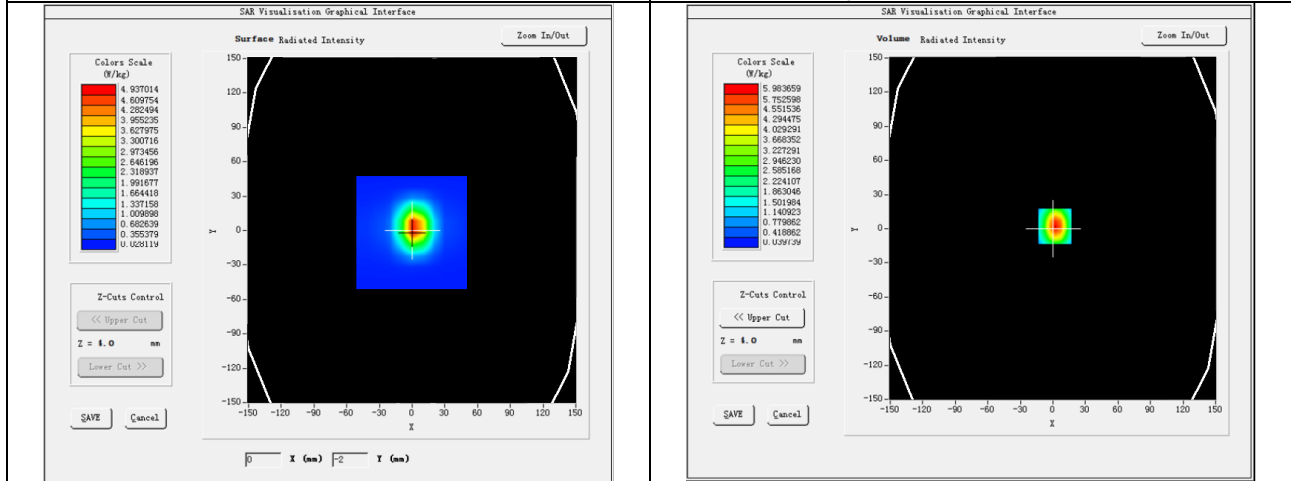

Test specification:	System Verification			Result:	Pass
Environ Conditions:	Temp(oC):	22			
	Humidity (%):	58			
	Atmospheric(mPa):	1008			
Mains Power:	N/A				
Test Date:	01/05/2023				
Tested by:	Devin Tai				
Remarks:	N/A				

Frequency (MHz)	5800.000000
Relative permittivity (real part)	35.351
Conductivity (S/m)	5.331
Probe SN	2715_EPGO259
Area Scan Resolution	8 mm
Zoom Scan Resolution	dx=8mm, dy=8mm, dz=5mm
Zoom Scan Size	32x32x34 mm
Measurement Drifts (%)	1.231
Highest Extrapolated SAR (W/Kg)	6.362
SAR 1g (W/Kg)	5.628

Peak SAR Location: 6mm(x), -6mm(y), 4mm(z)

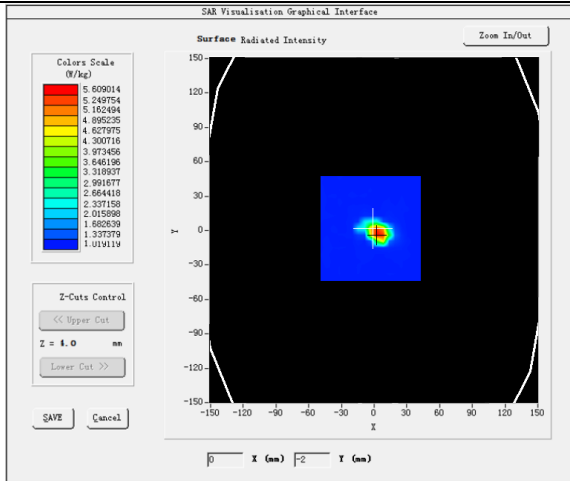

SURFACE SAR

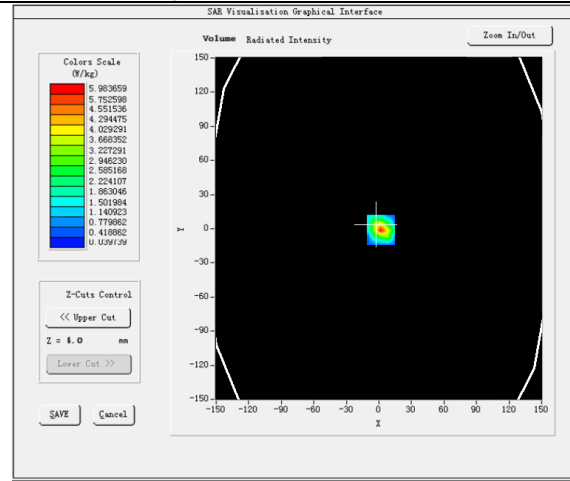

VOLUME SAR

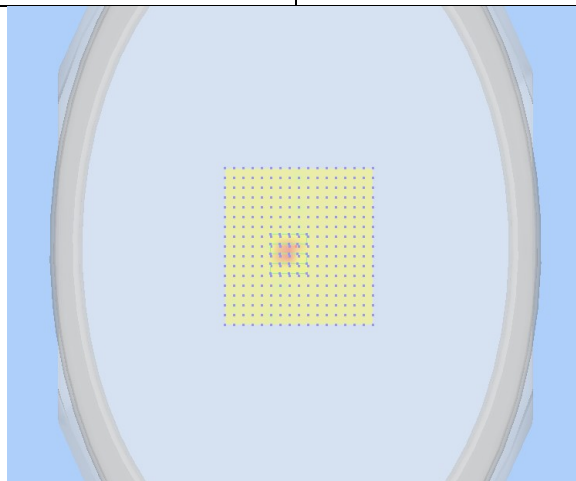

3D View Plot

10.2.4 SAR Test Plots of measurement result_2.4G Band

Test specification:	Plane_Body_Front_11b-2462MHz			Result:	Pass
Environ Conditions:	Temp(oC):	22			
	Humidity (%):	56			
	Atmospheric(mPa):	1008			
Mains Power:	14.8 VDC battery				
Test Date:	01/04/2023				
Tested by:	Devin Tai				
Remarks:	N/A				

Frequency (MHz)	2462.000000 (Channel 11)
Relative permittivity (real part)	39.214
Conductivity (S/m)	1.792
Probe SN	2715_EPGO259
Area Scan Resolution	8 mm
Zoom Scan Resolution	dx=8mm, dy=8mm, dz=5mm
Zoom Scan Size	32x32x34 mm
Measurement Drifts (%)	-0.790
Highest Extrapolated SAR (W/Kg)	0.0252
SAR 1g (W/Kg)	0.0231
Peak SAR Location	-80mm(x),-80mm(y),4mm(z)

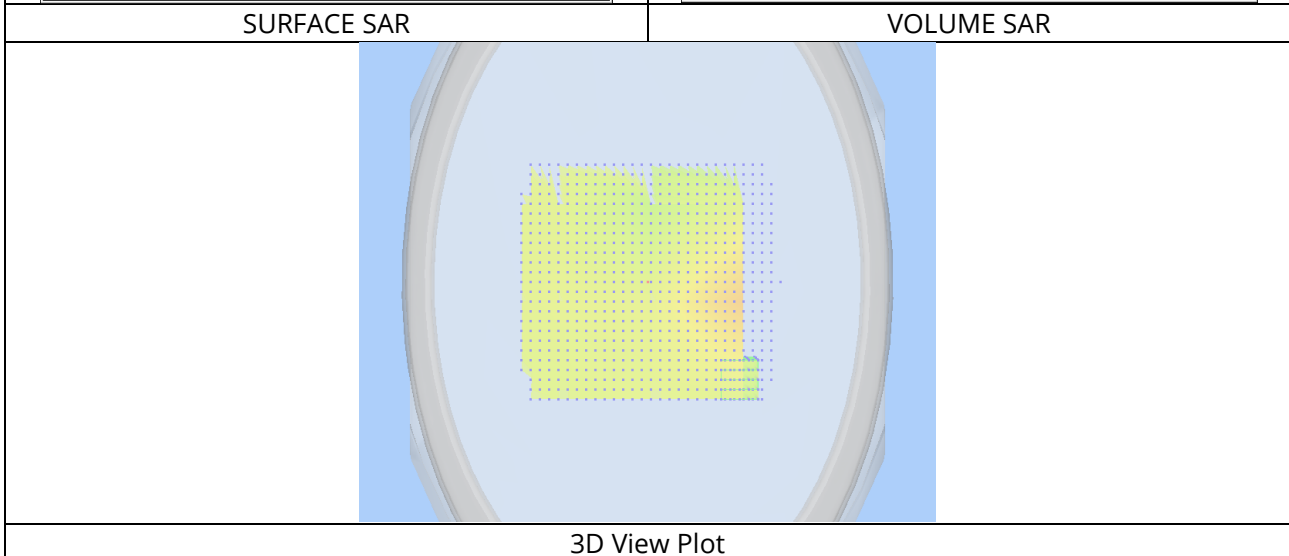
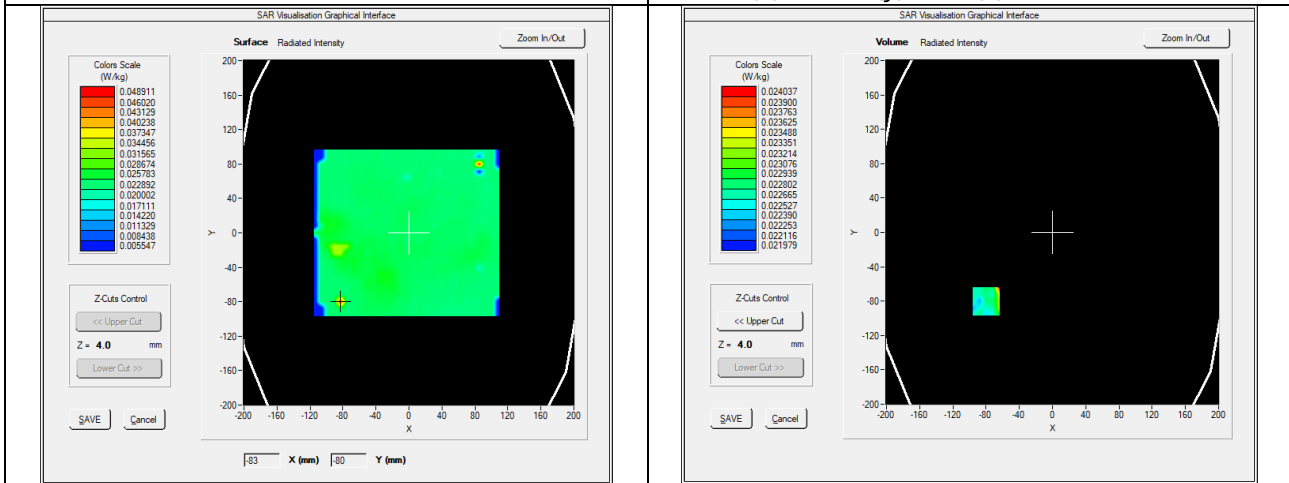

Test specification:	Plane_Body_Left-11b-2462MHz			Result:	Pass
Environ Conditions:	Temp(oC):	22			
	Humidity (%):	56			
	Atmospheric(mPa):	1008			
Mains Power:	14.8 VDC battery				
Test Date:	01/04/2023				
Tested by:	Devin Tai				
Remarks:	N/A				

Frequency (MHz)	2462.000000 (Channel 11)
Relative permittivity (real part)	39.233
Conductivity (S/m)	1.792
Probe SN	2715_EPGO259
Area Scan Resolution	8 mm
Zoom Scan Resolution	dx=8mm, dy=8mm, dz=5mm
Zoom Scan Size	32x32x34 mm
Measurement Drifts (%)	1.170
Highest Extrapolated SAR (W/Kg)	0.1145
SAR 1g (W/Kg)	0.0753
Peak SAR Location	-75mm(x),-8mm(y),4mm(z)

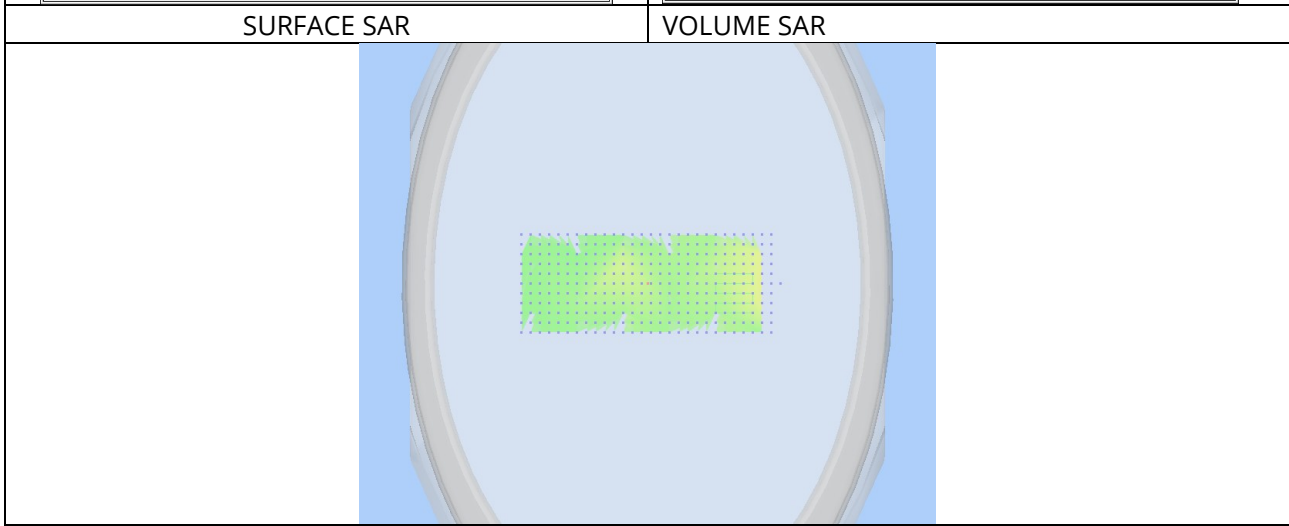
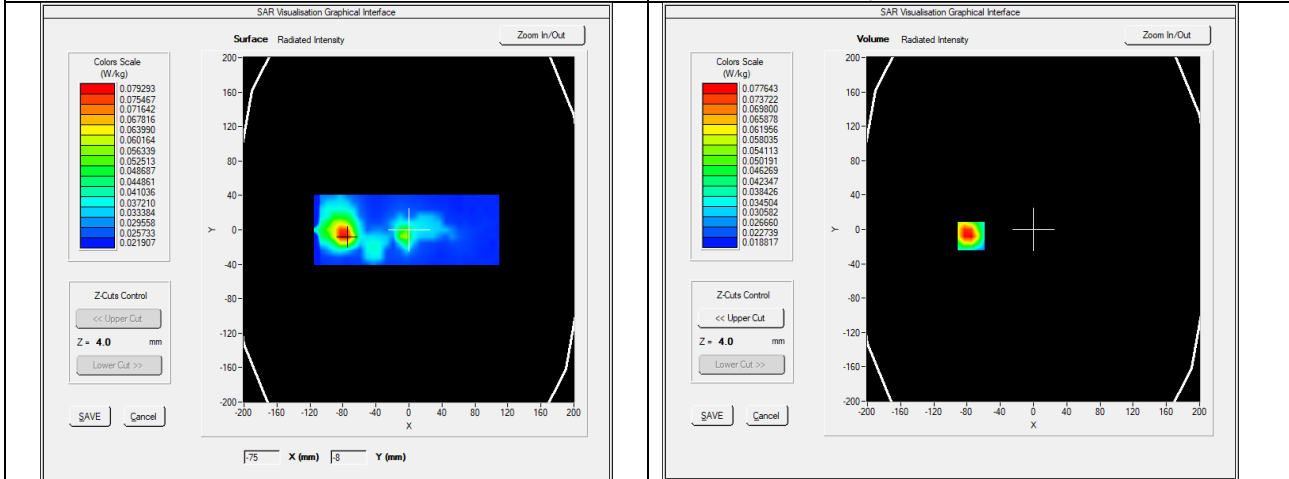

3D View Plot

10.2.5 SAR Test Plots of measurement result_5G Band

Test specification:	Plane_Body_Front-11a-5200MHz			Result:	Pass
Environ Conditions:	Temp(oC):	22			
	Humidity (%):	56			
	Atmospheric(mPa):	1008			
Mains Power:	14.8 VDC battery				
Test Date:	01/05/2023				
Tested by:	Devin Tai				
Remarks:	N/A				

Frequency (MHz)	5200.000000 (Channel 40)
Relative permittivity (real part)	35.243
Conductivity (S/m)	4.732
Probe SN	2715_EPGO259
Area Scan Resolution	8 mm
Zoom Scan Resolution	dx=8mm, dy=8mm, dz=5m m
Zoom Scan Size	32x32x34 mm
Measurement Drifts (%)	-1.780
Highest Extrapolated SAR (W/Kg)	0.1485
SAR 1g (W/Kg)	0.0852
Peak SAR Location	-16mm(x),38mm(y),4mm(z)

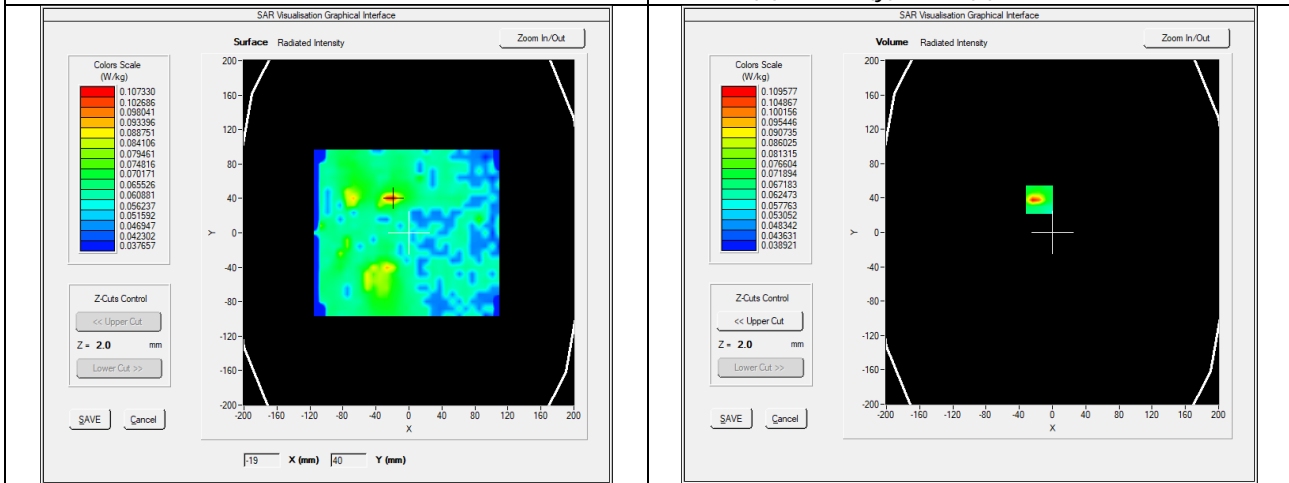

SURFACE SAR

VOLUME SAR

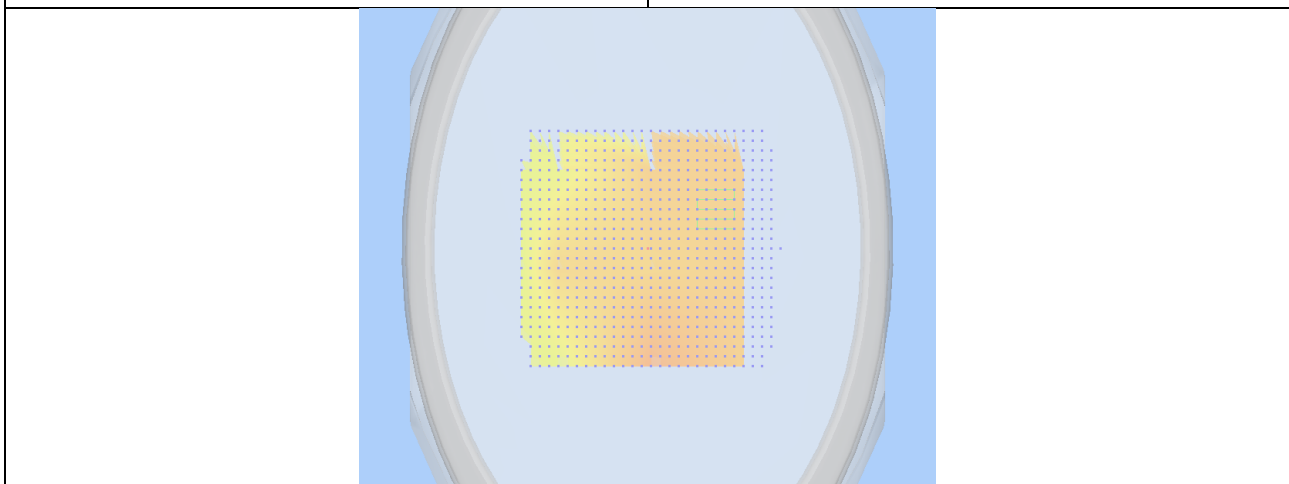

3D View Plot

Test specification:	Plane_Body_Left-11a-5200MHz		
Environ Conditions:	Temp(oC):	22	Result: Pass
	Humidity (%):	56	
	Atmospheric(mPa):	1008	
Mains Power:	14.8 VDC battery		
Test Date:	01/05/2023		
Tested by:	Devin Tai		
Remarks:	N/A		

Frequency (MHz)	5200.000000 (Channel 40)
Relative permittivity (real part)	35.243
Conductivity (S/m)	4.732
Probe SN	2715_EPGO259
Area Scan Resolution	8 mm
Zoom Scan Resolution	dx=8mm, dy=8mm, dz=5m m
Zoom Scan Size	32x32x34 mm
Measurement Drifts (%)	-0.720
Highest Extrapolated SAR (W/Kg)	0.6242
SAR 1g (W/Kg)	0.2507
Peak SAR Location	8mm(x),0mm(y),4mm(z)

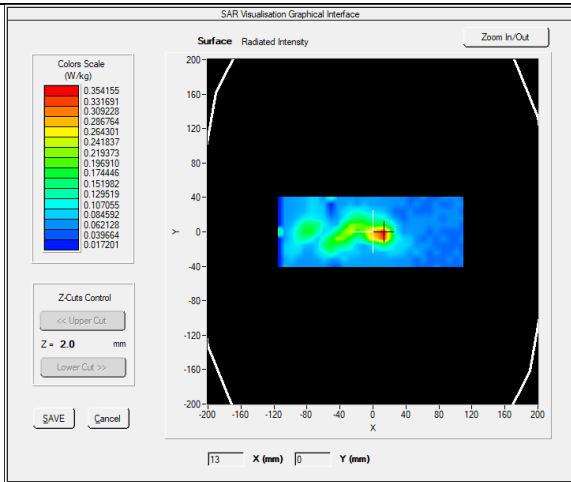

SURFACE SAR

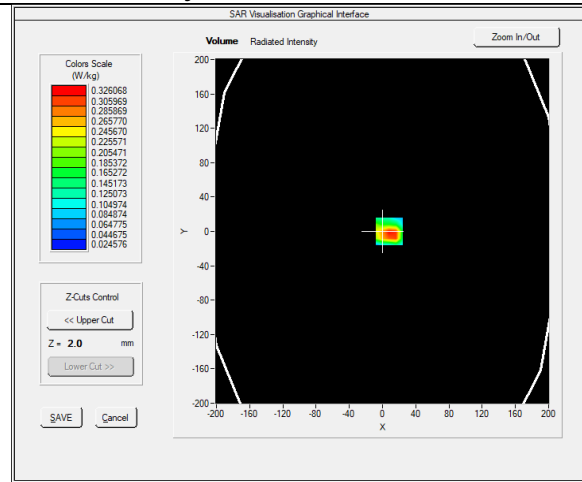

VOLUME SAR

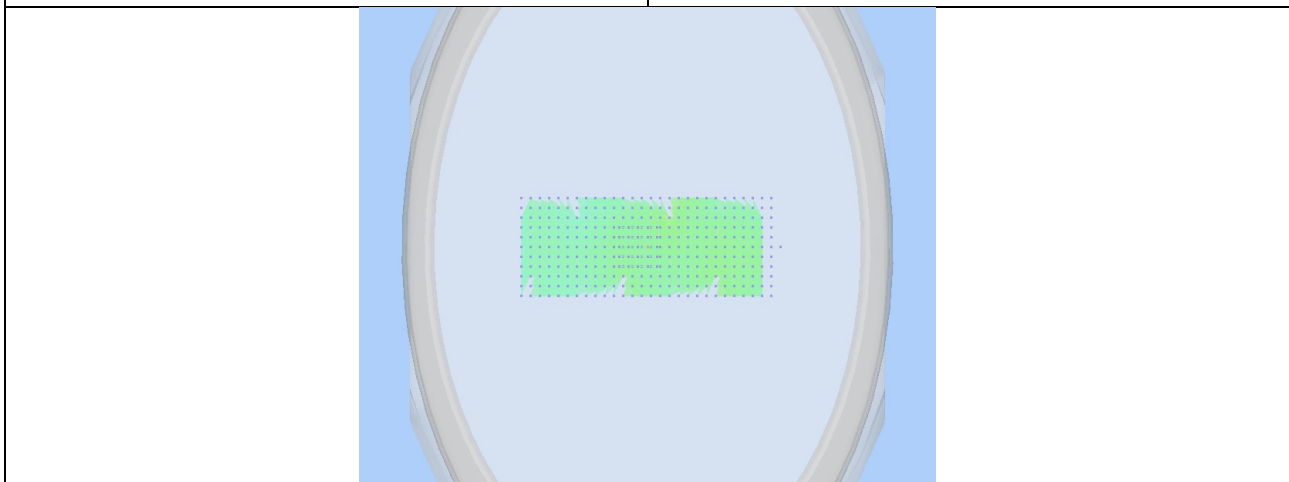

3D View Plot

11 EUT and Test Setup Photos

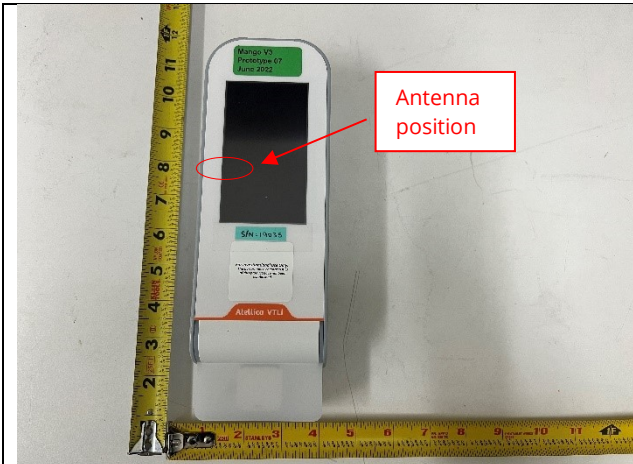

Host Product-External-Front (SAR test position)



Host Product-External-Back



Host Product-External-Top

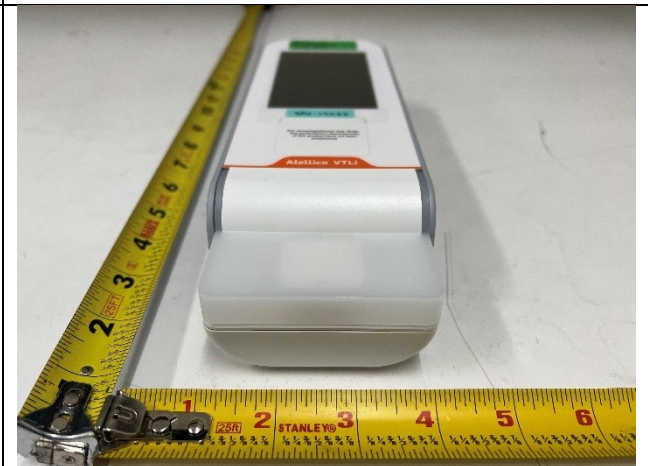

Host Product-External-Bottom



Host Product-External-Left (SAR test position)



Host Product-External-Right

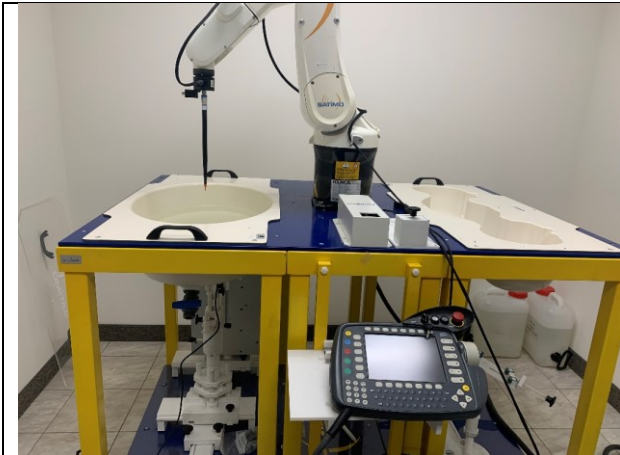

SAR Test System



Test Setup - System verification

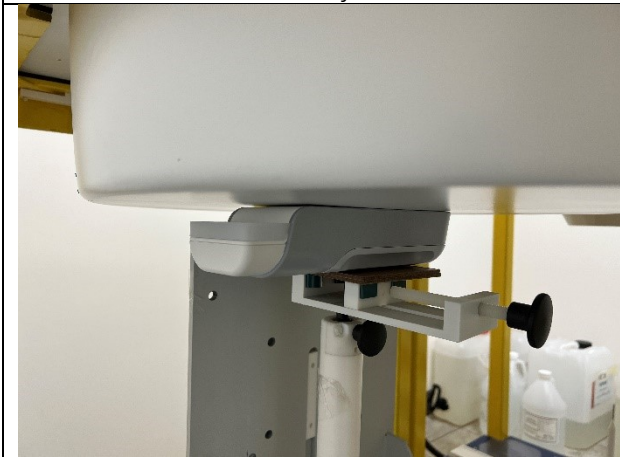

Test Setup - Front Position



Test Setup - Left Side Position

12 Test Instrument List

Equipment	Manufacturer	Model	Instrument Number	Cal. Date	Cal. Due
6 Axis Robot	KURA	KR5 KRC2sr	949319	N/A	N/A
MultiMeter	Keithley	MultiMeter 2000	1259033	06/07/2022	06/07/2023
E-Field Probe	SATIMO	SSE2	SN 27/15 EPGO259	07/21/2022	07/21/2024
Dipole 2450	SATIMO	DIPOLE 2450 MHz	SN 31/10 DIPJ138	07/21/2022	07/21/2024
Waveguide 5/6 GHz	SATIMO	Wave Guide 5/6 GHz	SN 31/10 DIPWGA13	07/21/2022	07/21/2024
T-Coil Porbe	SATIMO	TCP15	SN 31/10 TCP15	07/14/2021	07/14/2023
Laptop Positioning Device	SATIMO	LSH13	SN 31/10 LSH13	N/A	N/A
Mobile Phone Positioning Device	SATIMO	MSH63	SN 31/10 MSH63	N/A	N/A
COMOHAC TMFS	SATIMO	TMFS08	SN 31/10 TMFS08	N/A	N/A
SAM Phantom	SATIMO	SAM77	SN 31/10 SAM77	N/A	N/A
Elliptic Phantom	MVG	ELLI38	SN 03-16 ELLI38	N/A	N/A
Phantom Table	SATIMO	N/A	N/A	N/A	N/A
Reference tool for VPS	MVG	RT58	SN 03/16 RT 58	N/A	N/A
KUKA Roboter KRC2sr	KUKA	KRC2sr	2057	N/A	N/A
Elliptic Phantom	SATIMO	ELLI17	SN 31-10 ELLI17	N/A	N/A
Network Analyzer 30KHz-6GHz	Agilent	8753ES	US39170256	06/09/2022	06/09/2023
3.5mm Calibration Kit	Agilent	85033E	MY39205936	N/A	N/A
MXG Vector Signal Generator	Keysight	N5182A	US47080548	06/07/2022	06/07/2023
USB RF Power Sensor	ETS-Lindgren	7002-006	SN 00151268	06/07/2022	06/07/2023
EMC Test Receiver	R&S	ESL6	100230	06/07/2022	06/07/2023
Spectrum Analyzer	Keysight	N9020A	MY50110074	06/09/2022	06/09/2023

---END---