



Moving Health Forward

Raizer[®] II

User Manual



Raizer® II

The Raizer is a battery-powered mobile lifting chair which helps a lying person up to an almost standing position in a few minutes.

The Raizer can be operated by only a single assistant and requires minimal physical effort from the assistant aside from a helping hand.

The Raizer is simple to operate by means of the control panel mounted on the side of the seat, or with the remote control.

Contents

1. Indications/Contraindications for Use	04
2. Technical Specifications	05
3. Safety Instructions	08
4. Functionality	09
5. Prior to Use	09
6. Operation	10
7. Disassembly	14
8. Charging the Raizer	14
9. Maintenance	14
10. Service Inspections	16
11. Spare Parts & Accessories	17
12. Troubleshooting	20
13. Electrical Diagram	20
14. Disposal	21
15. Declaration	21
16. Regulatory Approvals	23

1. Indications/Contraindications for Use

1.1 Intended Use

The Raizer should only be used to bring a person lying on the floor to a seated or almost standing position, if the person is unable to do so by him-/herself. The person may require relocation from this position. A hygiene cover or a form of textile must be applied to the seat if the person to be lifted is NOT wearing clothes on areas in direct contact with the Raizer.

The max. load of the Raizer is stated on the CE mark on the rear of the seat. The Raizer can be used approx. 40 times at full load on a full charge. A charger is included with your Raizer.



Movable parts: Be careful not to get crushed. Service inspections must always be undertaken by a qualified service technician. The owner of the device is obliged to maintain it according to the maintenance guide in section 9. It is strictly forbidden to modify the product as this may endanger people's personal safety.



The Raizer's parts may be hot or cold to touch in case they have been stored in the baggage compartment of a car or in direct sunlight. Please consider this before using the device.



Lifting capacity: Max. 150 kg (330.7 lbs)



Do not push or transport the lifting chair while the person is sitting in it. The Raizer is not designed for transport of persons.



Do not stand on the lifting chair. The Raizer is not designed for transport of persons.



Never flush the lifting chair with water and never immerse it in water. General cleaning may only be done using a well-wrung cloth or sponge



Read the user manual thoroughly before using the lifting chair



Do not dispose of batteries, electrical or electronic equipment with unsorted household rubbish. When disposing of this device, ensure compliance with local ordinances and regulations.

2. Technical Specifications

2.1 Dimensional Drawings

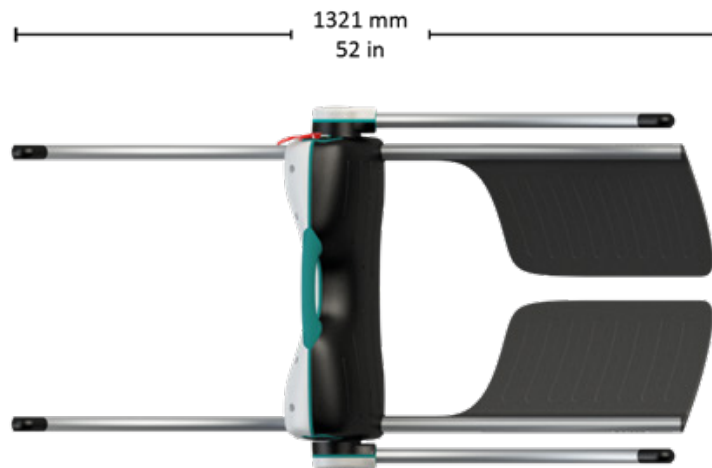
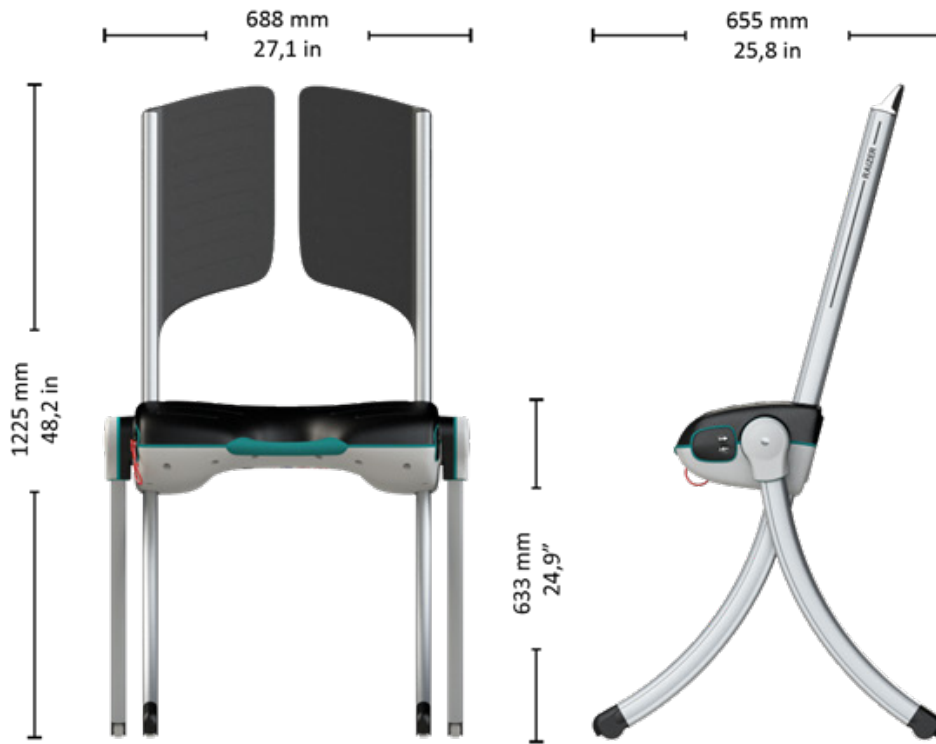

2.2 Specifications

Battery:	LiFePO ₄ , 12V, 5AH
Number of lifts on full charge:	40 with a max. load. Approx. 80 with an average load
Duty cycle:	1 min. / 5 min.
Charging time:	Up to 6 hours with the provided charger
Charging of depleted battery:	10-15 min. = 1 lift
Dimensions (L x W x H):	Standing - 655mm x 688mm x 1225mm Lying - 1321mm x 688mm x 277mm
Weight:	Motor unit/seat - 9.2kg Backrest and legs - 4.9kg Total weight - 14.1kg
Lifting capacity:	Max. 150 kg / 330.7 lbs
Lifting time:	20-30 sec.
Noise level:	<70dB(A)
Dust and water:	IP52
Operating forces of controls:	<3N (300g)
Working temperature:	+5°C to +40°C
Storage temperature:	-25°C to +70°C
Materials:	Motor unit/seat - Polycarbonate and ABS Backrests - Polycarbonate and ABS Legs - Aluminium

The Raizer meets the relevant requirements, notably the following standards:

EN/ISO 10535:2007	Hoists for the transfer for disabled persons
EN 12182:2012	Assistive products for persons with disability - General requirements and test methods
EN 60601-1:2006+Corr-1,-2:2008 +AC, A1:2013	Medical electrical equipment - Part 1
EN 60601-1-11:2015	Requirements for medical electrical equipment and medical electrical systems used in the home healthcare environment

2.3 Specifications USB Charger

USB Type A	Min. 5Volt 1 Ampere
------------	---------------------

2.4 Specifications Charger

Type 2241 4-cell LiFePO₄ Charger

Input voltage:	100-240V nom. Min. Max. 90-264 VAC
Power:	Max 15W
Output voltage:	14.6V
Dimensions (L x W x H):	120mm x 47mm x 70mm
Weight:	170g
Working temperature:	+5°C to +40°C
Storage temperature:	-25°C to +70°C

Dust and water: IP4X
 Expected service life: >5 years

2.5 Specifications Radio Components

All radio components comply with the following standards:

EU2014/53/EU	Radio Equipment Directive (RED)
FCC (USA)	CFR 47 Part 15
ISED (Industry Canada)	RSS-210
EN 62479:2010	Assessment of the compliance of low power electronic and electrical equipment with the basic restrictions related to human exposure to electromagnetic fields (10 MHz to 300 GHz)
EN 300 440, v2.1.1	Electromagnetic compatibility + Radio spectrum Matters
BS EN 60601-1-2:2015	Medical electrical equipment - Part 1-2: Electromagnetic disturbances
CISPR 11, Class B	Emission
BS EN 61000-4-2:2009	EMC - Testing and measurement techniques. Electrostatic discharge immunity test
EN 61000-4-3:2006+ A1:2008+IS1:2009+ A2:2010	EMC - Radiated, RF, electromagnetic field immunity test
EN 61000-4-8:2010	EMC - Power frequency magnetic field immunity test
AS/NZS 4268	Radio Equipment and Systems –Short Range devices
AS/NZS 2772.2	Radio Frequency Fields (mean power < 1 mW)

MODULE1:

2,4GHz Short Range device	Receiver Class 3; FCC ID:2A8IL-MODULE1, IC: 29071-MODULE1
Dimensions (L x W x H):	72mm x 33mm x 10mm
Weight:	10 g (0,035 lbs.)
Frequencies:	2.410GHz 2.435GHz and 2.460GHz
Duty cycle:	< 1%(only TX for pairing Remotes)
Power:	< 0.6mW Controlled environment
Supply:	5.6 Volt 30mA
Dust and water:	IP 52 (protected from limited dust ingress; protected from water spray)
Working temperature:	+5°C to+40°C
Storage temperature:	-25°C to +70°C
Expected service life:	>5 years

Handheld REMOTE:

2,4GHz Short Range device	Receiver Class 3; FCC ID:2A8IL-REMOTE1, IC: 29071-REMOTE1
Dimensions (L x W x H):	80mm x 60mm x 21mm
Weight:	47 g (0.10 lbs.)
Frequencies:	2.410GHz 2.435GHz and 2.460GHz
Duty cycle:	<1%
Power:	<0.6mW Controlled environment, Hold to run

Battery:	3 Volt CR2032
Dust and water:	IP 42
Operating forces of controls	< 3N (300g)
Working temperature:	+5°C to +40°C / 41°F to 104°F
Storage temperature:	-25°C to +70°C / 13°F to 158°F
Expected service life:	>5 years

3. Safety Instructions

3.1 Avoid Personal Injury



Even though the Raizer comes fitted with various safety features, never use it if persons or animals unintendedly are close by, as this may lead to the risk of crushing. Never allow children to play with the Raizer.

3.2 Personal safety

- To avoid personal injury, it is NOT permitted to use the lifting chair when someone or something is at risk of being injured by crushing, cutting, falling, slipping, or similar.
- It is important that the assistant ensures that the chair can move without putting anyone or anything at risk.
- Be extra careful when there are children and physically or mentally challenged people on or near the chair, as these groups cannot always be expected to be able to foresee the possible consequences of its movements.
- Never load more on the chair than the 150 kg (330.7 lbs) stated on the loading sign as the maximum load.
- Our recommendation is to never use the lifting chair if the person is not secured with the seat-fitted safety belt.

6.4 Safety belt

- The Raizer is fitted with a lap belt when delivered. The lap belt will offer safety and security and help keep the person in position during the lift. Several safety belts can be ordered as spares.
- However, it is important to note that the lap belt will not support the torso, so additional arrangements should be used if necessary.

6.5 Handling

The Raizer will normally be supplied by your dealer. The lifting chair is ready for use upon delivery. The Raizer can be transported in the 2 provided bags. One is a protective cover for the seat itself. The seat is carried in the turquoise handle.

The backrest and legs are carried in the bag by using carrying straps for hand or back (long strap for shoulders or two straps as a backpack).

Do not subject the Raizer to severe knocks or blows as this can affect product functionality.

Keep the accompanying remote control dry and do not subject it to severe blows, such as by throwing it or dropping it, etc. Cleaning may only be done using a well-wrung cloth.



Never use a high-pressure jet or running water to rinse the chair and never immerse it in water, as this can damage the product.



4. Functionality

The Raizer is a battery-powered mobile lifting chair which raises a fallen person up to an almost standing position in a few minutes. It can be operated by only a single assistant and requires no physical effort from the assistant aside from a helping hand.

The lifting chair works by the assistant assembling the Raizer around the fallen person and is operated by using the control panel on the seat or by means of the remote control. The assistant can raise the fallen person to a sitting or almost standing position ready for relocation.

To use the Raizer, hold down the button for the entire lift. The lifting will stop if the button is released.

5. Prior to Use



Make sure that the Raizer is always fully charged. A charger and an adapter cable for USB charging are supplied with the device, and we recommend that the Raizer always be charged and ready for use. You should check the Raizer for power at least once every 6 months and recharge if necessary. See also section 8.

5.1 Charging the Raizer

The Raizer must be charged for at least 6 hours prior to its first-time use, as required and as a minimum every 6 months with the provided charger).

It is advisable to check the battery indicator on the side of the lifting chair to verify the level of the charger.

Charging may also be done using the USB cable; however, this takes considerably longer than with the charger (approx. 20 hours for a full charge).

Check that the chair is charged prior to use. The battery indicator must not flash red.

The Raizer can be stored anywhere you like. However, lifting speed will be reduced if the battery temperature falls below 0°C. In practice, though, if charged, the Raizer will always be able to perform its task, even if stored in a vehicle in a severe frost (-15°C). However, you must bear in mind that components which are either very hot or cold, may be uncomfortable to touch.

5.2 Operating the Raizer

The control panel is situated on the right side of the seat.

To turn on the Raizer, press the on/off button or the UP/DOWN arrow keys on the side of the chair. Check that the chair is charged prior to use. The battery indicator must not flash red.

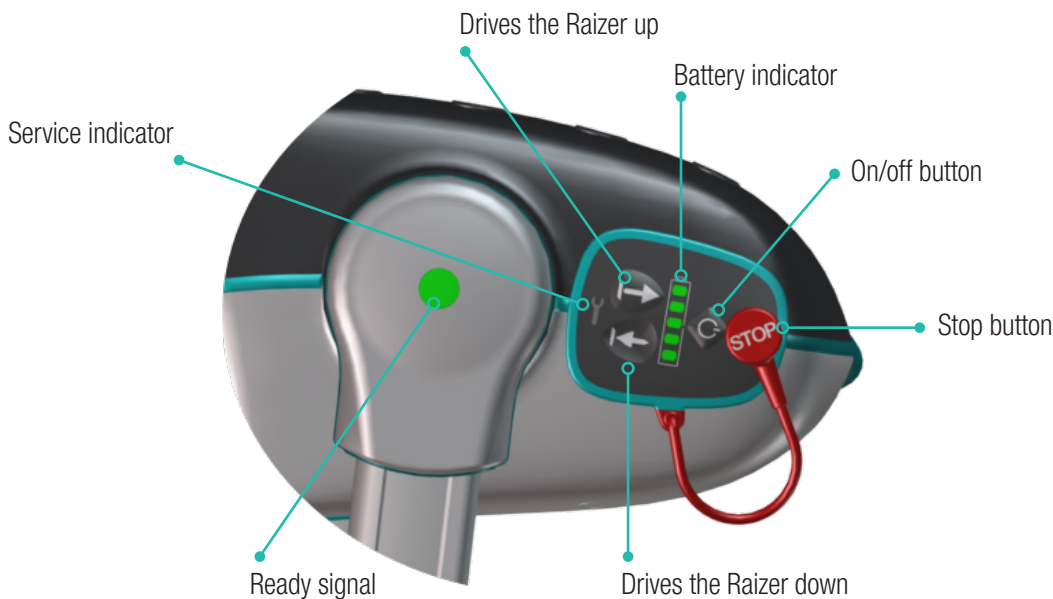

The Remote Control

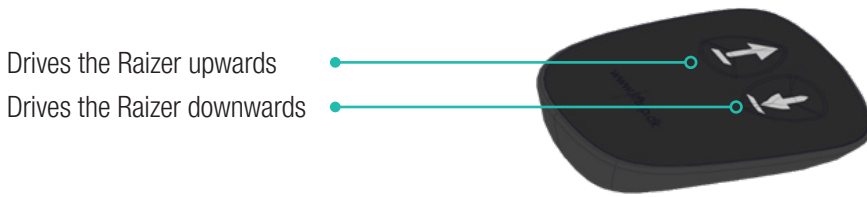

Drives the Raizer upwards

Drives the Raizer downwards

The remote control is placed in a pocket on the side of the seat and fixed with a magnet. It is released with a light push to the upper part of the remote control.

BE CAREFUL not to lose the remote control when releasing it from the Raizer.

1. Press the UP arrow to drive the lifting chair upwards.
2. The Raizer will only run for as long as the button is activated.

NOTE:

The Raizer must be turned on for the remote control to work (by a light push of the on/off button on the side of the chair).

1. The stop button is activated when it is required to stop any movement of the Raizer. Pull the button or the cord to release the button from its position. The Raizer can only be reactivated when the stop button has been remounted.

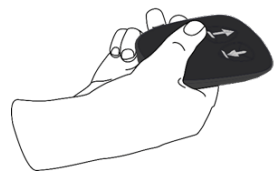
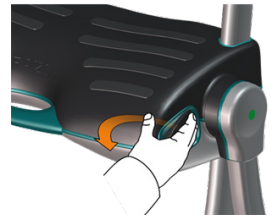

6. Operation

6.1 Assembling the Raizer



IMPORTANT!

Please observe that the backrest should be attached at first. If the legs are attached at first, it will disturb the fitting of the backrest. Fit one side at a time.

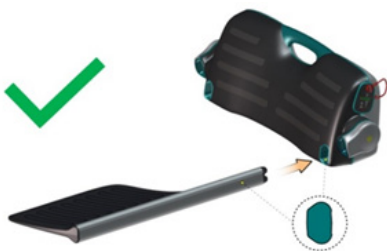

*Correct assembly
(first mount the backrest)*



*Incorrect assembly
(do not mount the legs first)*

6.2 Placing the Raizer

1. Arrival and approach.
You may place a pillow under the person's head for better comfort.
2. Place the seat on the floor next to the lying person. The person must lie on the back. Lift the thighs to an angle. Carefully push the seat under the thighs.

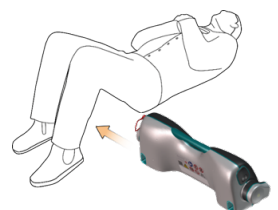
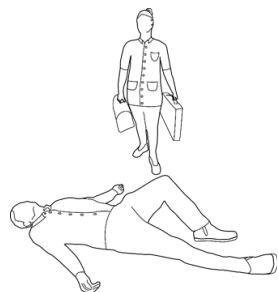

NOTE!

Always attach the backrest at first. If the legs are attached at first, it will disturb the fitting of the backrest.

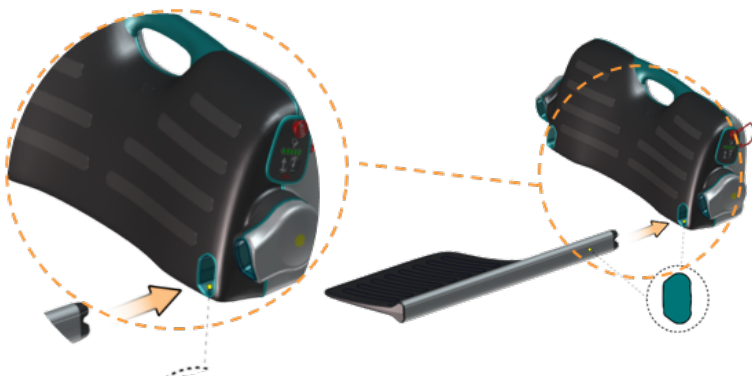

Take care that the backrest is attached into the correct hole

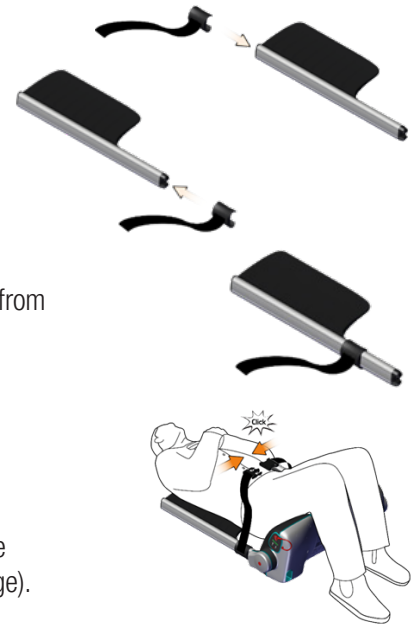

6.3 Mounting the Seat Belt

1. If the seat belt has not already been fitted on the backrest, mount it by pushing the fitting downwards over the backrest profile with a sliding movement. The fitting can be mounted from both ends (see illustrations).
2. Fasten the seat belt. A distinct click will be heard.



3. **WARNING!** Never lead the seat belt under the rear legs of the Raizer, as this may cause the person to be crushed. (The seat belt clip however will break off before any personal damage).



6.4 Mounting the Backrests

Left backrest

1. Lift the person carefully by the shoulder, with a light push to the elbow. Push the backrest carefully under the shoulder of the person.
2. Click the backrest into place in the seat with a sliding movement. If necessary, place your foot in front of the seat to stop it from slipping forward. A confirmation tone will sound, when the backrest has been correctly fitted.

Right backrest

1. Lift the person carefully by the shoulder, with a light push to the elbow. Push the backrest carefully under the shoulder of the person.
2. Click the backrest into place in the seat with a sliding movement. If necessary, place your foot in front of the seat to stop it from slipping forward. A confirmation tone will sound, when the backrest has been correctly fitted.

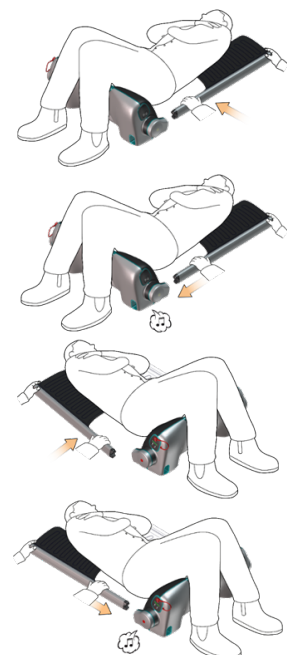

6.5 Mounting the Legs

NOTE! All 4 legs are identical and may be fitted in any sequence.

Left rear leg

Insert the leg carefully, until it clicks into place. A confirmation tone will sound when the leg has been correctly fitted.

Left front leg

Insert the leg carefully, until it clicks into place. A confirmation tone will sound when the leg has been correctly fitted.

Right rear leg

Insert the leg carefully, until it clicks into place. A confirmation tone will sound when the leg has been correctly fitted.

Right front leg

Insert the leg carefully, until it clicks into place. A double confirmation tone will sound when the last leg has been correctly fitted.

Ready signal

When all 4 legs have been fitted correctly, a double confirmation tone will follow.

The double alert signifies that the Raizer is ready to lift a person.

The LED light on the side of the Raizer now changes from yellow to green to demonstrate that the Raizer is ready for operation.

6.6 Headrest

We recommend supporting the neck and head of the person to be lifted as it may be hard to keep the head upright during the lift. In most cases, in connection with the Raizer II lifting chair, we recommend that the helper supports the person's neck with one hand during the lifting process while simultaneously operating the remote control with the other hand.

However, in cases where it is necessary or practical for the helper to have both hands free, a headrest (accessory) may be a great help.

To apply the headrest, push it under the neck of the lying person so that it slides between the two backrests.

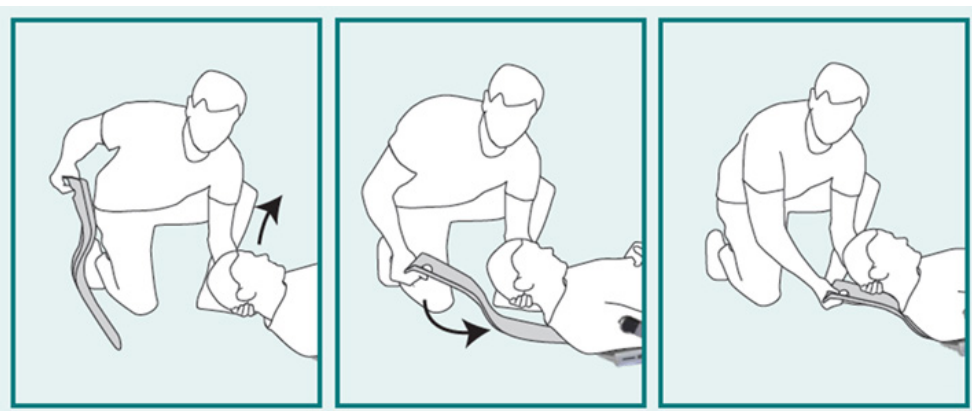
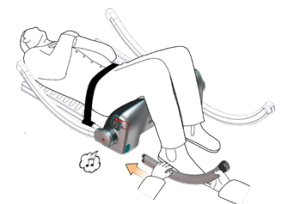
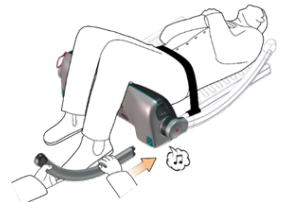

6.7 Alerts Prior to Lifting a Person

Positioning the person

Make sure that the shoulders of the person are placed suitably on the Raizer and that the arms are crossed over the chest, as the rear legs will move downwards towards the floor as soon as the UP arrow is pressed and may hit the person should shoulder/arms be in the way.

Rear legs

Please watch out for a potential crushing between the rear legs and the floor. Make sure to keep hands and feet at a safe distance from the movement of the legs.

Front legs

Take care that the person's legs are together and that feet/legs are not at risk of getting in under a front leg when the chair is raised, as the front legs move toward the floor before the chair begins to lift the person.

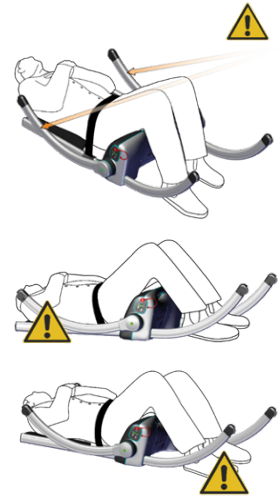

DO NOT run the chair up before you have made sure that the person's feet, arms, hands and other extremities will not be endangered by the movements of the lifting chair.

6.8 Lifting a Person

1. The Raizer is operated by using the control panel on the seat or by means of the remote control.
2. The remote control is placed in a pocket on the side of the seat and fixed with a magnet. It is released with a light push to the upper part of the remote control. BE CAREFUL not to lose the remote control when releasing it from the Raizer
3. The Raizer is now ready to lift the person. Before initiating the lift, make sure that the person is ready, and give a warning that the lift will begin.
4. Support the neck of the person with one hand or apply a headrest (accessory). Press the "UP arrow" on the side panel or the remote control.
5. Press the UP arrow until the person has reached the requested position.
6. The Raizer will automatically stop when reaching its top position and the person is in an upright sitting position.

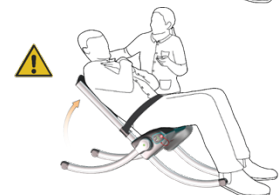
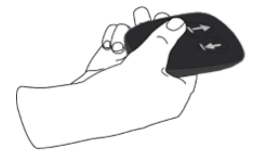
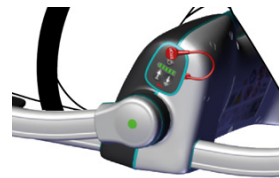

NOTE:

The Raizer is safeguarded against running too high and therefore stops automatically in its top position. A confirmation tone will sound, indicating that the Raizer has reached its top position.



NEVER push the Raizer when a person is sitting on it. The wheels of the legs are only meant to avoid scratches to the floor in connection with the lifting procedure. The Raizer is not designed for transport of persons.

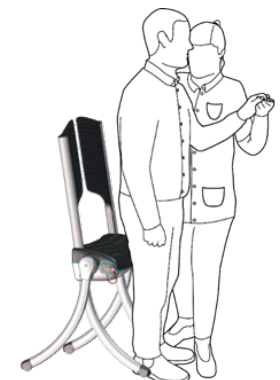

7. Disassembly



IMPORTANT! Always run the Raizer to the horizontal position prior to disassembly (otherwise the next assembly of the Raizer will be upset).

When the Raizer has been run into the horizontal position and is ready for disassembly, place the remote control in its pocket at the side of the seat. If all legs are dismantled and the remote control has not been put back into its pocket, the Raizer will begin to 'call out' for the remote control with a warning tone (a vibrant tone). As soon as the remote control is in place, the warning tone will cease.

Always run the Raizer to the horizontal position (until it stops with a distinct sound), prior to disassembly (otherwise the next assembly of the Raizer will be upset).

The Raizer is disassembled by pulling all legs (4) and backrests (2) out.

Do not forget to place the remote control in its pocket, as otherwise a vibrant warning tone will sound when all legs have been dismantled.

When the Raizer has been disassembled, all parts are stowed away in the transport bag.



8. Charging the Raizer

The battery indicator (LED) lights green when the battery is fully charged.

The battery indicator (LED) flashes red to show that the battery capacity is below 10% and the Raizer must be recharged.

NOTE:

The indicator only lights up when the lifting chair is turned on.

The charger socket is situated in the same place as the red stop button.

1. Remove the stop button and plug the charger cable into the socket. The plug is mounted with a magnet and will snap into place by itself.
2. Connect the provided charger to the socket on the Raizer. Or use the provided USB cable.

NOTE: Charging with the USB cable takes considerably longer than with the charger.



The Raizer must be charged for at least 6 hours prior to its first-time use, as required and as a minimum every 6 months (with the provided charger). Approx. 10-15 minutes' charging is sufficient for 1 lift. A full charge gives approx. 40 lifts at room temperature. The number of lifts will be reduced at lower temperatures.



9. Maintenance

9.1 Cleaning

IMPORTANT: General cleaning may only be done using a well-wrung cloth or sponge.

The Raizer is **NOT** waterproof and therefore must not be immersed in water or flushed with running water. It is however acceptable to clean the Raizer with a damp cloth.



The Raizer must **NOT** be flushed with water



The Raizer must **NOT** be immersed in water

You can disinfect your Raizer by using the below disinfectants recommended:

Hydrogen Peroxide Aq.: 1,0% (max.) (diluted hydrogen peroxide)

Ethanol based products: 70-85 v/v%. alcohol

Soap solutions: PH value max. 9



NEVER use a high-pressure cleaner or other power flushing or running water, as this may cause permanent damage to the lifting chair.

9.2 Mechanical Maintenance

The mechanical maintenance of the Raizer shall normally only be undertaken in connection with the regular annual service inspection. This is to be undertaken by a qualified service technician in accordance with section 10.

Should unexpected errors or unusual sounds occur, contact DHG.

9.3 Maintenance of the Transport Bags

The provided transport bags may be cleaned with a well-wrung cloth or in the washing machine at max. 30°C. You can disinfect the bags by using alcohol-based disinfectants at a concentration of 70–85 v/v%.



Wash at max. 30°C



No tumble drying



No ironing



No bleach

9.4 Pairing the Transmitter and the Receiver (Remote Control)

1. The Raizer battery must be fully charged, see section 8.
2. The Raizer must be switched off either using the on/off button or await the Raizer switching off automatically after 10 minutes without activity.
3. Press the UP and DOWN arrows of the remote control at the same time and keep them pressed for approx. 5 seconds until the control LED on the remote control begins to flash slowly. The remote control is now in installation mode for 2 minutes.
4. Within these 2 minutes, switch on the lifting chair you require paired/associated with the remote control by pressing the UP/DOWN arrows on the side of the chair simultaneously.
5. The control LED on the remote control is paired/associated with the lifting chair when it stops flashing.
6. Test the system to make sure that the pairing has been performed correctly; if not, repeat steps 1-5 above.

Resetting the transmitter and the receiver:

To reset a remote control so that it is no longer paired/associated with the Raizer, do the following:

1. Press the UP and DOWN arrows at the same time and keep them pressed down for approx. 5 seconds until the control LED begins to flash slowly. The remote control is now in installation mode for 2 minutes.
2. Within the 2 minutes, perform the following sequence:

Press: UP, UP, DOWN, DOWN, UP, DOWN, UP, DOWN

When the control LED starts to flash quickly, the remote control is no longer associated/paired with the Raizer.

Alternatively:

If the remote control is open, you may push “reset” to restore the initial state.



9.5 The Remote Control

A CR2032 battery is installed in the remote control.

 In order to ensure reliable function, swap the battery every 2 years

 Be careful not to swallow the coin cell

 Keep batteries out of reach of small children. Should a child swallow a battery, consult a physician immediately

 Do not dispose of batteries, electrical or electronic equipment with unsorted household rubbish. When disposing of this device, ensure compliance with local ordinances and regulations.

Replacing the remote control battery:

1. Loosen the screw (Torx TX 6) on the rear of the remote control.
2. Remove the back panel
3. Swap the battery
4. Refit the back panel and make sure that the remote control is working correctly

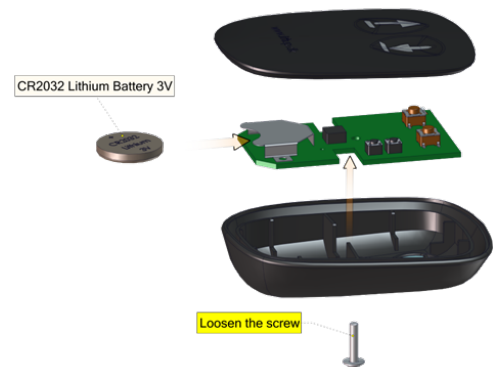

10. Service Inspections

Under normal conditions of operation, a service life of >5 years may be expected, provided that the product is maintained in accordance with the guidelines of the producer. In addition to the general maintenance described in section 9, we recommend routine annual inspections (+/- one month) performed by a qualified service technician.

For models with the automatic service indicator activated, the Raizer will begin to flash a service message when it is time for the service inspection. Also, an acoustic alarm will sound to remind you that service is due.

In case the automatic service indicator has been deactivated, a label on the product will inform you accordingly, and service intervals may be arranged with the local dealer at your discretion.

The dealer you have bought the Raizer from will offer this service, but if you wish to use another service provider, you as the owner of the Raizer are responsible for ensuring that the chosen service technician is suitably qualified in the product in question.



For safety reasons it is very important that these inspections are maintained, since lacking or improperly performed inspections may result in personal injury.

All service inspections performed must be logged in the service logbook.





11. Spare Parts & Accessories



IMPORTANT: It is important to use only original spare parts. Replacement of parts may only be undertaken by a qualified service technician. The use of non-original spare parts may void the right of complaint. Furthermore, product safety may be compromised, which may pose a risk to personal safety.

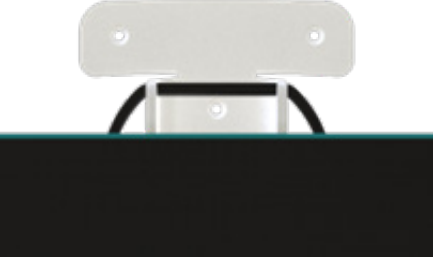

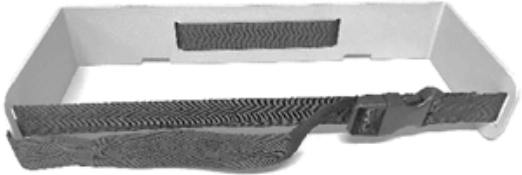
Part No.	Description	Photo
105192	Battery Charger, 15W, Magnetic Male	
105082	Charger Cable USB	
107463	Carry Case (Including Quick Guides)	

<p>107240</p>	<p>Cover for Seat</p>	
<p>107693</p>	<p>Wall Bracket (Optional Equipment)</p>	
<p>107273</p>	<p>Trolley (Optional Equipment)</p>	
<p>107374</p>	<p>Clip and Belt</p>	
<p>104913</p>	<p>Hanger for Trolley</p>	

<p>103314</p>	<p>Triple Wheel for Trolley, 2 pcs. (Optional Equipment)</p>	
<p>103313</p>	<p>Bike Bracket Kit, Trolley (Optional Equipment)</p>	
<p>103741</p>	<p>Disposable Hygiene Cover (10 pcs.) (Optional Equipment)</p>	
<p>102890</p>	<p>Battery 12V 5Ah LifFePo4 Raizer</p>	
<p>107230</p>	<p>Stop Device for Raizer II</p>	

12. Troubleshooting

You can find helpful videos which will provide you with information on signals and troubleshooting, assembly and disassembly at our DHG website: www.dhg-healthcare.com

13. Electrical Diagram

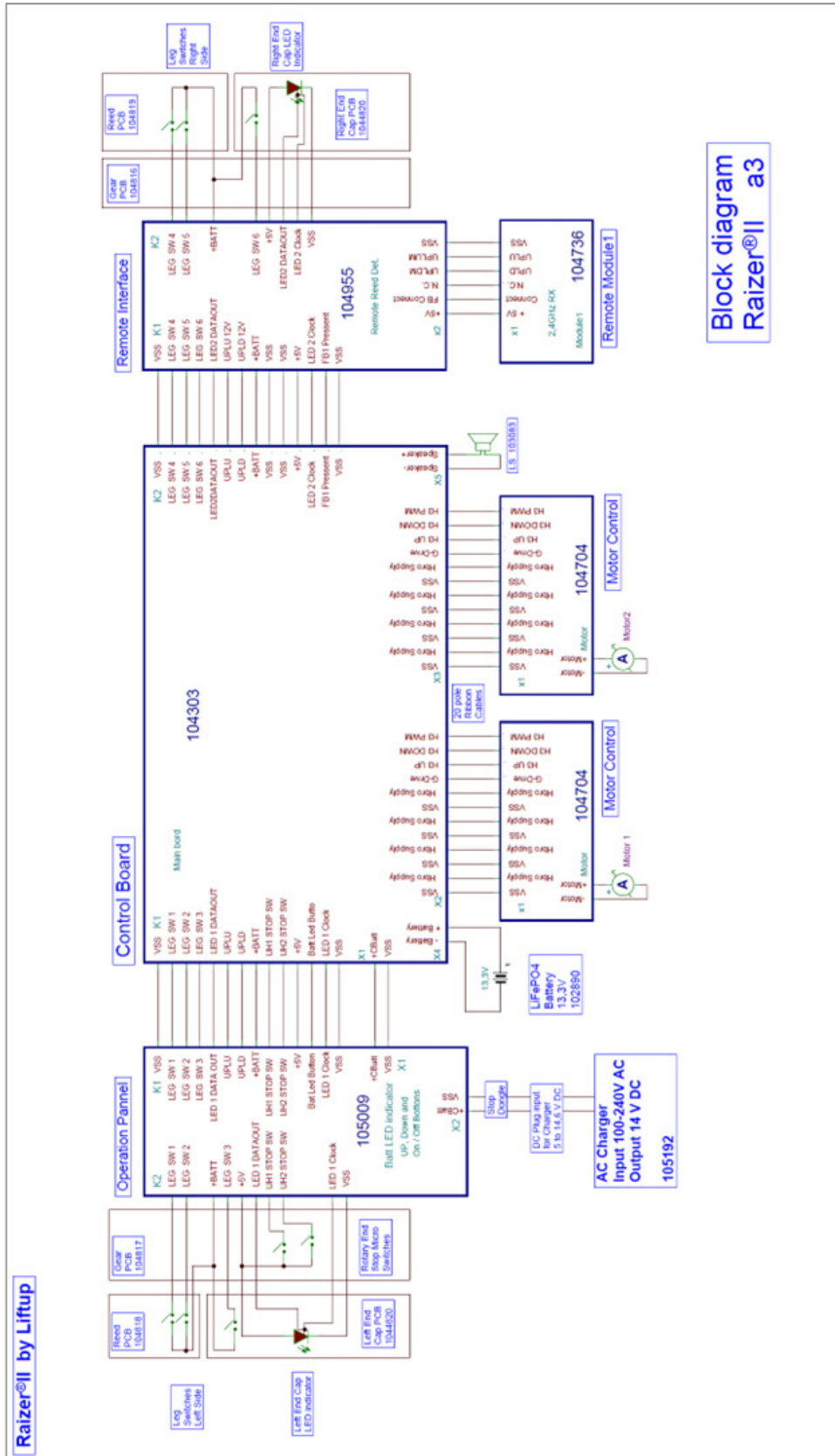

Block diagram
Raizer®II a3

14. Disposal

It is the duty of the owner to dispose of the product in accordance with the regulations applicable at the time. Please note that the control unit and remote control contain batteries, which must be disposed of separately.



NOTE: Do not dispose of batteries or electrical or electronic equipment with unsorted household rubbish. When disposing of this device, ensure compliance with local ordinances and regulations.

15. Declaration

Legal Manufacturer:

Direct Healthcare Group Ltd
 Withey Court, Western Industrial Estate
 Caerphilly, United Kingdom
 CF83 1BF
 T: +44 (0) 800 043 0881
 F: +44 (0) 845 459 9832
 E: info@directhealthcaregroup.com

Product Limited Warranty

Subject to the terms and conditions set forth herein, Direct Healthcare Group Ltd. (“DHG”) makes the following warranty only to its Resellers who purchase the Raizer II hardware product (“Product”) directly from DHG: for a period of one (1) year from the date of shipment from DHG, the Product will substantially conform to DHG’s standard published specifications for the Product and the Product hardware will be substantially free from defects in materials and workmanship. The foregoing warranty shall not apply to embedded software/firmware components.

THIS PRODUCT LIMITED WARRANTY IS PROVIDED TO RESELLERS AND TO RESELLERS ONLY. RESELLER IS SOLELY RESPONSIBLE FOR ANY AND ALL WARRANTIES MADE TO ITS CUSTOMERS, AND DHG MAKES NO WARRANTIES, EXPRESS OR IMPLIED, AND SHALL HAVE NO OBLIGATIONS OR LIABILITY TO RESELLER’S CUSTOMERS OR END-USERS OF THE PRODUCT. RESELLER SHALL NOT MAKE ANY REPRESENTATIONS OR WARRANTIES ON DHG’S BEHALF, AND SHALL FULLY INDEMNIFY, DEFEND AND HOLD DHG HARMLESS FROM ANY BREACH OF THE FOREGOING. IF RESELLER DISTRIBUTES PRODUCT TO END-USER CUSTOMERS, RESELLER SHALL BE SOLELY RESPONSIBLE FOR PREPARING AND PROVIDING PRODUCT WARRANTIES AND PRODUCT LITERATURE TO END-USERS.

Warranty Remedies

If the Product fails during the warranty period for reasons covered by this Product Limited Warranty and Reseller notifies DHG of such failure during the warranty period, DHG at its option will repair OR replace the nonconforming Product, OR refund the purchase price paid by Reseller for the Product, provided that Reseller returns the Product to DHG in accordance with DHG’s standard return material authorization procedures or as otherwise instructed by DHG.

Warranty Exclusions and Disclaimers

The foregoing Product Limited Warranty shall only apply in the event and to the extent that (i) the Product is properly and correctly installed, configured, interfaced, maintained, stored and operated in accordance with DHG’s specifications, and (ii) the Product is not modified or misused. This Product Limited Warranty shall not apply to, and DHG shall not be responsible for, defects or performance problems resulting from: (a) the combination or utilization of the Product with hardware or software products, information, data, systems, interfaces, services or devices not made, supplied or specified by DHG; (b) the operation of the Product under any specifications other than, or in addition to, DHG’s standard published specifications for the Product; (c) the unauthorized installation, modification or use of the Product; (d) damage caused by:

accident, lightning or other electrical discharge, water immersion or spray, or exposure to environmental conditions for which the Product is not intended; or (e) normal wear and tear on consumable parts, including by way of example and without limitation, batteries.

DHG DOES NOT WARRANT OR GUARANTEE THE RESULTS OBTAINED THROUGH THE USE OF THE PRODUCT. THE FOREGOING TERMS OF THE PRODUCT LIMITED WARRANTY STATE DHG'S ENTIRE LIABILITY, AND RESELLER'S EXCLUSIVE REMEDIES, RELATING TO THE USE AND PERFORMANCE OF THE PRODUCT EXCEPT AS OTHERWISE EXPRESSLY PROVIDED FOR IN THIS PRODUCT LIMITED WARRANTY, THE PRODUCT, ACCOMPANYING DOCUMENTATION AND MATERIALS, AND/OR ANY EMBEDDED SOFTWARE/FIRMWARE AND UPDATES THERETO ARE PROVIDED "AS-IS" AND WITHOUT EXPRESS OR IMPLIED WARRANTIES OF ANY KIND, BY EITHER DHG OR ANYONE WHO HAS BEEN INVOLVED IN ITS CREATION, PRODUCTION, INSTALLATION OR DISTRIBUTION, INCLUDING, BUT NOT LIMITED TO, THE IMPLIED WARRANTIES OF MERCHANTABILITY AND FITNESS FOR A PARTICULAR PURPOSE, TITLE AND NONINFRINGEMENT. THE STATED EXPRESS WARRANTIES ARE IN LIEU OF ALL OBLIGATIONS OR LIABILITIES ON THE PART OF DHG ARISING OUT OF, OR IN CONNECTION WITH, THE PRODUCT. WITHOUT LIMITING THE GENERALITY OF THE FOREGOING:

THE PRODUCT MAY CONTAIN TECHNOLOGY THAT IS NOT FAULT TOLERANT AND IS NOT DESIGNED, MANUFACTURED OR INTENDED FOR USE IN ENVIRONMENTS OR APPLICATIONS IN WHICH THE FAILURE OF THE PRODUCT WOULD LEAD TO DEATH, PERSONAL INJURY OR SEVERE PHYSICAL OR ENVIRONMENTAL DAMAGE OR SEVERE FINANCIAL LOSS. ANY USE OR DISTRIBUTION BY RESELLER OR ITS CUSTOMERS IN CONNECTION WITH ANY SUCH ENVIRONMENT OR APPLICATION SHALL BE AT RESELLER'S AND ITS CUSTOMERS' SOLE RISK, AND DHG SHALL HAVE NO LIABILITY WHATSOEVER IN CONNECTION THEREWITH. RESELLER SHALL INDEMNIFY AND HOLD DHG AND ITS SUPPLIERS HARMLESS FROM ANY CLAIM BROUGHT AGAINST DHG WHICH ARISES FROM RESELLER'S USE OR DISTRIBUTION OF THE PRODUCT IN CONNECTION WITH SUCH ENVIRONMENTS OR APPLICATIONS. SOME STATES AND JURISDICTIONS DO NOT ALLOW LIMITATIONS ON DURATION OR THE EXCLUSION OF AN IMPLIED WARRANTY, SO CERTAIN OF THE ABOVE LIMITATIONS MAY NOT APPLY TO EVERY RESELLER.

Embedded Software/Firmware

The Product and associated tools, if any, may contain embedded software/firmware, which is licensed, not sold, and is only for use within the Product as an integral part thereof. Such embedded software/firmware (which includes all updates thereto) contains valuable trade secrets and is proprietary to DHG and its suppliers. To the greatest extent permitted by law, such embedded software/firmware may not be modified, copied, disassembled, decompiled or reverse engineered. DHG reserves all other rights.

Limitation of Liability

DHG'S ENTIRE LIABILITY REGARDING THE PRODUCT SHALL BE LIMITED TO THE AMOUNT ACTUALLY PAID BY RESELLER FOR THE PRODUCT. TO THE MAXIMUM EXTENT PERMITTED BY APPLICABLE LAW, IN NO EVENT SHALL DHG OR ITS SUPPLIERS BE LIABLE FOR ANY INDIRECT, SPECIAL, INCIDENTAL OR CONSEQUENTIAL DAMAGES WHATSOEVER UNDER ANY CIRCUMSTANCE OR LEGAL THEORY RELATING IN ANY WAY TO THE PRODUCTS, ACCOMPANYING DOCUMENTATION AND MATERIALS, AND ANY EMBEDDED SOFTWARE/FIRMWARE AND UPDATES THERETO (INCLUDING, WITHOUT LIMITATION, DAMAGES FOR LOSS OF BUSINESS PROFITS,

BUSINESS INTERRUPTION, LOSS OF DATA OR ANY OTHER PECUNIARY LOSS), REGARDLESS OF WHETHER DHG HAS BEEN ADVISED OF THE POSSIBILITY OF ANY SUCH LOSS AND REGARDLESS OF THE COURSE OF DEALING BETWEEN DHG AND RESELLER. BECAUSE SOME STATES AND JURISDICTIONS DO NOT ALLOW THE EXCLUSION OR LIMITATION OF LIABILITY FOR CONSEQUENTIAL OR INCIDENTAL DAMAGES, THE ABOVE LIMITATION MAY NOT APPLY TO EVERY RESELLER.

Notices

Class B Statement – Notice to Users. This equipment has been tested and found to comply with the limits for a Class B digital device, pursuant to Part 15 of the FCC rules. These limits are designed to provide reasonable protection against harmful interference in a residential installation. This equipment generates,

uses, and can radiate radio frequency energy and, if not installed and used in accordance with the instructions, may cause harmful interference to radio communication. However, there is no guarantee that interference will not occur in a particular installation. If this equipment does cause harmful interference to radio or television reception, which can be determined by turning the equipment off and on, the user is encouraged to try to correct the interference by one or more of the following measures:

- Reorient or relocate the receiving antenna.
- Increase the separation between the equipment and the receiver.
- Consult the dealer or an experienced radio/TV technician for help.

Changes and modifications not expressly approved by the manufacturer or registrant of this equipment can void your authority to operate this equipment under Federal Communications Commission rules.

16. Regulatory Approvals

CE

The Raizer II product comply with the essential requirements of the RED Directive 2014/53/EU as stated by the EU Declaration of Conformity (CE). The Raizer II product comply with the European Telecommunications Standards Institute Specifications EN 300 440 operating in 2.400 GHz to 2.483 GHz band for Radio Equipment and Systems).

EU/ International

The Raizer II complies with the essential requirements of the 2011/65/EU directive on the restriction of the use of certain hazardous substances in electrical and electronic equipment (ROHS 2).

Complies with the essential requirements of the EU 1907/2006 regulation concerning the Registration, Evaluation, Authorization and Restriction of Chemicals (REACH).

Complies with the requirements of the 2002/96/EU directive on waste electrical and electronic equipment and directive 2006/66/EU on batteries and accumulators and waste batteries and accumulators (WEEE).

FCC/IC

The Raizer II and REMOTE products comply with the FCC Part 15.249 and the Innovation, Science and Economic Development (ISED) Canada requirements RSS-210

The Raizer II and REMOTE products comply with Part 15 of the FCC rules and with ISED license exempt standard(s). Operation is subject to the following two conditions:

1. This device may not cause harmful interference, and
2. This device must accept any interference received, including interference that may cause undesired operation.

The Raizer II and REMOTE products are SAR test excluded according to FCC KDB 447498, RSS102 and EN 62479 at separation distances larger than 5 mm and less than 50 mm.

With respect to radiofrequency radiation exposure Information, it is declared; that this equipment complies with FCC radiation exposure limits set forth for an uncontrolled environment. This gives an extra margin, since the remote control normally, only is used in “controlled environment” for approx. 30 seconds when lifting, and typically only a few times a day.

ACMA (AUS/NZ)

The Raizer II product complies with the Australian/New Zealand Radio communication Act for operation in 2400-2483 MHz.

Raizer II

Contains FCC ID: 2A8IL-MODULE1

Remote

2A8IL-REMOTE1

Contains IC: 29071-MODULE1
 HVIN: 103736

29071-REMOTE1
 HVIN: 105026

EU Declaration of Conformity: CE
 (RED and Medical Device Directive)

FCC and IC Statements

The Raizer II, Remote products contains radio transmitters that comply with CFR 47 Part 15.249 of the FCC rules and with RSS-102 and RSS-247 of Industry Canada requirements.

Notice statements according to CFR 47 Part 15.19 / RSS-GEN:

The Raizer II, Remote products complies with Part 15 of the FCC rules and with ISED license exempt standard(s). Operation is subject to the following two conditions:

- (1) This device may not cause harmful interference, and
- (2) This device must accept any interference received, including interference that may cause undesired operation.

Déclarations selon le RSS-GEN:

Le présent Raizer II, Remote appareil est conforme aux CNR, Innovation, Sciences et Développement économique Canada applicables aux appareils radio exempts de licence. L'exploitation est autorisée aux deux conditions suivantes:

- (1) l'appareil ne doit pas produire de brouillage, et
- (2) l'utilisateur de l'appareil doit accepter tout brouillage radioélectrique subi, même si le brouillage est susceptible d'en compromettre le fonctionnement.

NOTICE statements according to CFR 47 Part 15.21:

Changes or modifications made to this equipment not expressly approved by DHG Ltd. may void the FCC authorization to operate this equipment.

Statements according to CFR 47 Part 2.1091/2.1093 and OET bulletin 65/RSS-102:

The Raizer II and REMOTE products are SAR test excluded according to FCC KDB 447498, RSS102 and EN 62479 at separation distances larger than 5 mm and less than 50 mm with respect to the human body as the maximal radiated power is below the limits.

The Raizer II and REMOTE products are by declaration of RF Exposure Compliance for Exemption from Routine Evaluation Limits according to RSS-102

ATTESTATION:

It is attested that the radio communication apparatus meets the exemption from the routine evaluation limits in RSS-102 Section 2.5 of this standard; that the Technical Brief was prepared, and the information contained therein is correct; that applicable measurement methods and evaluation methodologies have been followed; and that the device meets the SAR and/or RF field strength limits of RSS-102.

This transmitter must not be co-located or operating in conjunction with any other antenna or transmitter.

SAR test exclusion according to EN 62479

The Raizer II and REMOTE products are compliant according to EN 62479 as the output power is less than 20 mW.

AUS/NZ:

The Raizer II complies with the AS/NZS 4268 requirements for 2.4 GHz transceiver.

This Page is Left Intentionally Blank

This Page is Left Intentionally Blank

This Page is Left Intentionally Blank



Moving Health Forward

PRESSURE ULCER PREVENTION
SAFE MOVING & HANDLING
SPECIALIST THERAPIES
BATHROOM SAFETY
RENTAL & SERVICE SOLUTIONS



Direct Healthcare Group Ltd
Withey Court, Western Industrial Estate
Caerphilly, United Kingdom
CF83 1BF

T: +44 (0) 800 043 0881
F: +44 (0) 845 459 9832
E: info@directhealthcaregroup.com

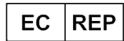

Direct Healthcare Group Sverige AB
Torshamnsgatan 35, SE-164
Kista, Sweden

T: +46 (0) 8 557 62 200



LIT-00155 Issue 01
Date: August 2022

DHG-HEALTHCARE.COM