

正面

INSPIROY DIAL 2

Q630M

- Quick Start Guide
- Guide de démarrage rapide
- Schnellstartanleitung
- クイックスタートガイド
- 빠른 시작 안내서
- Guida rapida
- Guía de inicio rápido
- Guia de inicio rápido
- Краткое руководство пользователя
- Przewodnik szybkiego startu
- Panduan Singkat

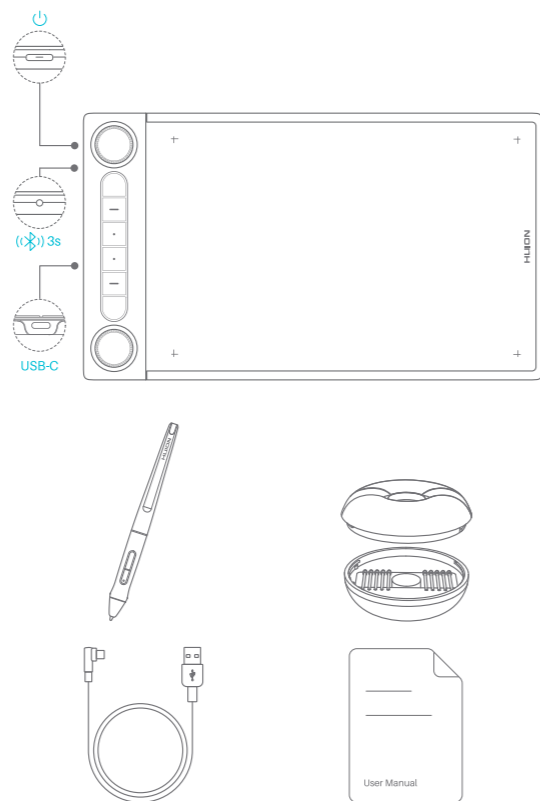
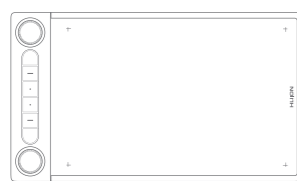

- 1** Wired Connection
- | | |
|---------------------------|----------------------|
| Connexion filaire | Conexión Por Cable |
| Kabelgebundene Verbindung | Conexão por Fio |
| 有線接続 | Проводное соединение |
| 유선 연결 | Połączenie Kablowe |
| Connessione cablata | Koneksi dengan Kabel |

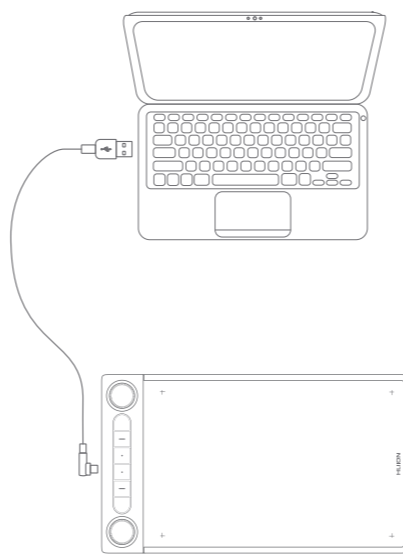

- 2** Bluetooth Connection
- | | |
|-----------------------|-----------------------|
| Connexion Bluetooth | Conexión Bluetooth |
| Bluetooth Verbindung | Conexão Bluetooth |
| Bluetooth-Verbindung | Подключение Bluetooth |
| 블루투스 연결 | Połączenie Bluetooth |
| Connessione Bluetooth | Koneksi Bluetooth |



3 www.huion.com/download

- Install Driver
- Installation du Pilote
- Installieren des Treibers
- ドライバーのインストール
- 드라이버 설치
- Installazione dei Driver
- Instalar el Driver
- Instalação do Driver
- Установка драйвера
- Instalacja sterownika
- Cara instalasi driver

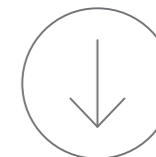

- User Manual
- Manuel de l'utilisateur
- Benutzerhandbuch
- ユーザーマニュアル
- 사용자 매뉴얼
- Manuale d'uso
- Manual de usuario
- Instrukcja obsługi
- Руководство пользователя
- Instrukcja obsługi
- Panduan pengguna



- 4** Replace the Pen Nib
- Remplacer la Pointe du Stylet
 - Wechseln der Stiftspitze
 - ペン先の交換
 - 펜촉 교체
 - Sostituzione del pennino
 - Recambio la Punta del Bolígrafo
 - Substituir a Ponta da Caneta
 - Замена наконечника пера
 - Wymiana końcówki pióra
 - Cara Mengganti Mata Pen (Nib)

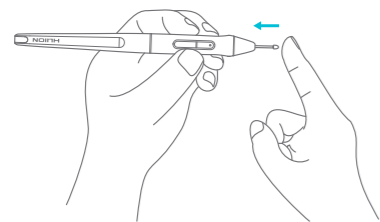
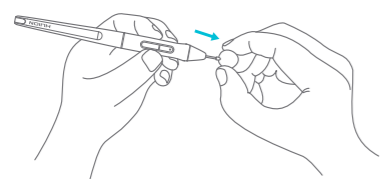
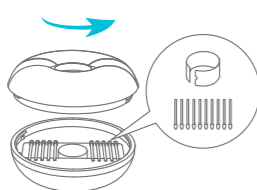

FCC Warning

This device complies with part 15 of the FCC Rules. Operation is subject to the following two conditions: (1) This device may not cause harmful interference, and (2) this device must accept any interference received, including interference that may cause undesired operation.

Any Changes or modifications not expressly approved by the party responsible for compliance could void the user's authority to operate the equipment.

Note: This equipment has been tested and found to comply with the limits for a Class B digital device, pursuant to part 15 of the FCC Rules. These limits are designed to provide reasonable protection against harmful interference in a residential installation. This equipment generates uses and can radiate radio frequency energy and, if not installed and used in accordance with the instructions, may cause harmful interference to radio communications. However, there is no guarantee that interference will not occur in a particular installation. If this equipment does cause harmful interference to radio or television reception, which can be determined by turning the equipment off and on, the user is encouraged to try to correct the interference by one or more of the following measures:

- Reorient or relocate the receiving antenna.
- Increase the separation between the equipment and receiver.
- Connect the equipment into an outlet on a circuit different from that to which the receiver is connected.
- Consult the dealer or an experienced radio/TV technician for help.

The device has been evaluated to meet general RF exposure requirement. The device can be used in portable exposure condition without restriction.

This device complies with part 15 of the FCC Rules. Operation is subject to the following two conditions:

- (1) This device may not cause harmful interference, and
- (2) this device must accept any interference received, including interference that may cause undesired operation.

FCC ID: 2A8IG-T221

IC Warning

This device complies with Industry Canada's licence-exempt RSSs. Operation is subject to the following two conditions:

- (1) This device may not cause interference; and
- (2) This device must accept any interference, including interference that may cause undesired operation of the device.

The device has been evaluated to meet general RF exposure requirement. The device can be used in portable exposure condition without restriction.

Cet appareil est conforme aux CNR exemptes de licence d'Industrie Canada. Son fonctionnement est soumis aux deux conditions suivantes:

- (1) Ce dispositif ne peut causer d'interférences; et
- (2) Ce dispositif doit accepter toute interférence, y compris les interférences qui peuvent causer un mauvais fonctionnement de l'appareil.

Le dispositif a été conçu pour répondre à la demande générale de radioexposition.

IC:29018-T221

CE Maintenance

- 1.Risk of explosion if battery is replaced by an incorrect type. Dispose of used batteries according to the instructions.
- 2.The product shall only be connected to a USB interface of version USB2.0.
- 3.EUT Operating temperature range:-10° C to 40° C .
- 4.The device complies with RF specifications when the device used at 0mm from your body.

Declaration of Conformity

Shenzhen Huion Animation Technology Co., Ltd. hereby declares that this Creative Pen Tablet is in compliance with the essential requirements and other relevant provisions of Directive 2014/53/EU.In accordance with Article 10(2) and Article 10(10), This product is allowed to be used in all EU member states.



IM.Q630M0-0-EN0000-0

Shenzhen Huion Trend Technology Co., Ltd.
 ☎ +86-755-32998548
 ✉ service@huion.com
 ● www.huion.com
 ○ www.huion.com/support

Warranty Card

Product Information

Product Name _____
 Buying Date _____
 Model _____

Dealer Information

Name _____
 Sale Date _____
 Phone _____
 Address _____

User Information

Name _____
 Email _____
 Phone _____
 Address _____

背面

设计说明		变更料号从X版升级为X版		深圳绘王趋势科技股份有限公司 Shenzhen Huion Trend Technology Co., Ltd.	
型号	Q630M 快速指南	第一版		部门	产品中心
尺寸	90(*5)x120mm (公差+/-1mm)	第二版		料号	IM.Q630M0-0-EN0000-0
材质	157G双铜纸	第三版		制图	李世彬
印刷	四色双面印刷	第四版		审核	倪庆
工艺	过哑胶	第五版		时间	2022.09.06
备注	风琴折页	第六版			