

FCC TEST REPORT

FCC ID: 2A8I3-BRPV4

Report Number: ZKT-220406L2203-02
Date of Test: Mar. 16, 2022 to Aug.30, 2022
Date of issue: Aug.30, 2022
Total number of pages.....: 57
Test Result: PASS

Testing Laboratory: Shenzhen ZKT Technology Co., Ltd.
Address: 1/F, No. 101, Building B, No. 6, Tangwei Community Industrial
Avenue, Fuhai Street, Bao'an District, Shenzhen, China

Applicant's name: Laser Tag Pro Inc.
Address: 9100 S. Nicholson Rd. Oak Creek, WI 53154 USA

Manufacturer's name: Dongguan Drosun Co., Ltd.
Address: No.20, Yewu 1st Road, Shipai Town, Dongguan City, Guangdong
Province

Test specification:
Standard.....: FCC CFR Title 47 Part 15 Subpart C Section 15.247
ANSI C63.10:2013
KDB558074 D0115.247 Meas Guidance v 05r02
Test procedure: /

Test Report Form No......: TRF-EL-110_V0

Test Report Form(s) Originator: ZKT Testing

Master TRF: Dated: 2020-01-06

This device described above has been tested by ZKT, and the test results show that the equipment under test (EUT) is in compliance with the FCC requirements. And it is applicable only to the tested sample identified in the report.

This report shall not be reproduced except in full, without the written approval of ZKT, this document may be altered or revised by ZKT, personal only, and shall be noted in the revision of the document.

Product name: Battle Rifle Pro
Trademark: N/A
Model/Type reference: BRP-V4
Ratings.....: DC7.4V from battery
AC 120V 60Hz

Testing procedure and testing location:

Testing Laboratory: **Shenzhen ZKT Technology Co., Ltd.**

Address: 1/F, No. 101, Building B, No. 6, Tangwei Community
Industrial Avenue, Fuhai Street, Bao'an District,
Shenzhen, China

Tested by (name + signature): Alen He 

Reviewer (name + signature).....: Joe Liu 

Approved (name + signature): Lake Xie 

Table of Contents

	Page
1. VERSION	5
2. SUMMARY OF TEST RESULTS	6
2.1 TEST FACILITY	6
2.2 MEASUREMENT UNCERTAINTY	7
3. GENERAL INFORMATION	7
3.1 GENERAL DESCRIPTION OF EUT	7
3.2 DESCRIPTION OF TEST MODES	9
3.3 BLOCK DIGRAM SHOWING THE CONFIGURATION OF SYSTEM TESTED	10
3.4 DESCRIPTION OF SUPPORT UNITS(CONDUCTED MODE)	10
3.5EQUIPMENTS LIST FOR ALL TEST ITEMS	11
4. EMC EMISSION TEST	12
4.1 CONDUCTED EMISSION MEASUREMENT	12
4.1.1 POWER LINE CONDUCTED EMISSION LIMITS	12
4.1.2 TEST PROCEDURE	12
4.1.3 DEVIATION FROM TEST STANDARD	12
4.1.4 TEST SETUP	13
4.1.5 EUT OPERATING CONDITIONS	13
4.1.6 TEST RESULT	14
4.2 RADIATED EMISSION MEASUREMENT	16
4.2.1 RADIATED EMISSION LIMITS	16
4.2.2 TEST PROCEDURE	17
4.2.3 DEVIATION FROM TEST STANDARD	17
4.2.4 TEST SETUP	18
4.2.5 EUT OPERATING CONDITIONS	19
4.2.6 TEST RESULTS	20
5.RADIATED BAND EMISSIONMEASUREMENT	27
5.1 TEST REQUIREMENT:	27
5.2 TEST PROCEDURE	27
5.3 DEVIATION FROM TEST STANDARD	28
5.4 TEST SETUP	28
5.5 EUT OPERATING CONDITIONS	28
5.6 TEST RESULT	29
6.POWER SPECTRAL DENSITY TEST	31
6.1 APPLIED PROCEDURES / LIMIT	31

6.2 TEST PROCEDURE	31
6.3 DEVIATION FROM STANDARD	31
6.4 TEST SETUP	31
6.5 EUT OPERATION CONDITIONS	31
6.6 TEST RESULT	32
7. -6DB CHANNEL BANDWIDTH	38
7.1 APPLIED PROCEDURES / LIMIT	38
7.2 TEST PROCEDURE	38
7.3 DEVIATION FROM STANDARD	38
7.4 TEST SETUP	38
7.5 EUT OPERATION CONDITIONS	38
7.6 TEST RESULT	39
8.OUTPUT POWER TEST	42
8.1 APPLIED PROCEDURES/LIMIT	42
8.2 TEST PROCEDURE	42
8.3 DEVIATION FROM STANDARD	42
8.4 TEST SETUP	42
8.5 EUT OPERATION CONDITIONS	42
8.6 TEST RESULT	43
9. CONDUCTED BAND EDGE AND SPURIOUS EMISSION	44
9.1 APPLICABLE STANDARD	44
9.2 TEST PROCEDURE	44
9.3 DEVIATION FROM STANDARD	44
9.4 TEST SETUP	44
9.5 EUT OPERATION CONDITIONS	44
9.6 TEST RESULTS	44
10. ANTENNA REQUIREMENT	56
11. TEST SETUP PHOTO	57
12. EUT CONSTRUCTIONAL DETAILS	57

1. VERSION

ReportNo.	Version	Description	Approved
ZKT-220406L2203-02	Rev.01	Initial issue of report	Aug.30, 2022

2. SUMMARY OF TEST RESULTS

Test procedures according to the technical standards:

FCC Part15 (15.247) , Subpart C			
Standard Section	Test Item	Result	Remark
FCC part 15.203/15.247 (c)	Antenna requirement	PASS	
FCC part 15.207	AC Power Line Conducted Emission	PASS	
FCC part 15.247 (b)(3)	Conducted Peak Output Power	PASS	
FCC part 15.247 (a)(2)	-6dB Channel Bandwidth& 99% OCB	PASS	
FCC part 15.247 (e)	Power Spectral Density	PASS	
FCC part 15.247(d)	Band Edge	PASS	
FCC part 15.205/15.209	Spurious Emission	PASS	

NOTE:

(1) "N/A" denotes test is not applicable in this Test Report

2.1 TEST FACILITY

Shenzhen ZKT Technology Co., Ltd.

Add. : 1/F, No. 101, Building B, No. 6, Tangwei Community Industrial Avenue, Fuhai Street, Bao'an District, Shenzhen, China

FCC Test Firm Registration Number: 692225

Designation Number: CN1299

IC Registered No.: 27033

2.2 MEASUREMENT UNCERTAINTY

The reported uncertainty of measurement $y \pm U$, where expanded uncertainty U is based on a standard uncertainty multiplied by a coverage factor of $k=2$, providing a level of confidence of approximately 95 %.

No.	Item	Uncertainty
1	Conducted Emission Test	$\pm 1.38\text{dB}$
2	RF powerconducted	$\pm 0.16\text{dB}$
3	Spurious emissionsconducted	$\pm 0.21\text{dB}$
4	All emissionsradiated(<1G)	$\pm 4.68\text{dB}$
5	All emissionsradiated(>1G)	$\pm 4.89\text{dB}$
6	Temperature	$\pm 0.5\text{C}$
7	Humidity	$\pm 2\%$

3. GENERAL INFORMATION

3.1 GENERAL DESCRIPTION OF EUT

Product Name:	Battle Rifle Pro
Model No.:	BRP-V4
Serial No.:	N/A
Hardware Version:	V2.0
Software Version:	V1.0
Sample(s) Status:	Engineer sample
Channel numbers:	802.11b/802.11g /802.11n(HT20):11
Channel separation:	5MHz
Modulation technology:	802.11b: Direct Sequence Spread Spectrum(DSSS) 802.11g/802.11n(H20): Orthogonal Frequency Division Multiplexing(OFDM)
Antenna Type:	FPC antenna
Antenna gain:	1.33 dBi
Power supply:	DC7.4V from battery AC 120V 60Hz
POWER ADAPTER:	Model: XSC-0901200S Input: 100-240V~50/60Hz 0.4 A Output: 9V \equiv 1200mA

Operation Frequency each of channel							
Channel	Frequency	Chann el	Frequency	Chann el	Frequency	Chann el	Frequency
1	2412MHz	4	2427MHz	7	2442MHz	10	2457MHz
2	2417MHz	5	2432MHz	8	2447MHz	11	2462MHz
3	2422MHz	6	2437MHz	9	2452MHz	X	

Note:

In section 15.31(m), regards to the operating frequency range over 10 MHz, the Lowest frequency, the middle frequency, and the highest frequency of channel were selected to perform the test, and the selected channel see below:

Test channel	Frequency (MHz)
	802.11b/802.11g/802.11n(HT20)
Lowest channel	2412MHz
Middle channel	2437MHz
Highest channel	2462MHz

3.2 DESCRIPTION OF TEST MODES

Transmitting mode	Keep the EUT in continuously transmitting mode
Remark: During the test, the duty cycle >98%, the test voltage was tuned from 85% to 115% of the nominal rated supply voltage, and found that the worst case was under the nominal rated supply condition. So the report just shows that condition's data.	

We have verified the construction and function in typical operation. All the test modes were carried out with the EUT in transmitting operation, which was shown in this test report and defined as follows:			
Pre-scan all kind of data rate in lowest channel, and found the follow list which it was worst case.			
Mode	802.11b	802.11g	802.11n(HT20)
Data rate	1Mbps	6Mbps	MCS0

Test Software	Realtek Test Tool
Powerlevelsetup	<20dBm

3.3 BLOCK DIGRAM SHOWING THE CONFIGURATION OF SYSTEM TESTED

Conducted Emission

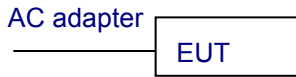

Radiated Emission

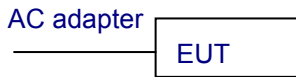

Conducted Spurious

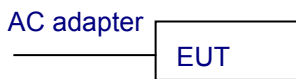

3.4 DESCRIPTION OF SUPPORT UNITS(CONDUCTED MODE)

The EUT has been tested as an independent unit together with other necessary accessories or support units. The following support units or accessories were used to form a representative test configuration during the tests.

Item	Equipment	Mfr/Brand	Model/Type No.	Series No.	Note
1	adapter	/	Model: XSC-0901200S Input: 100-240V~50/60Hz 0.4 A Output: 9V \equiv 1200mA	N/A	Provide by client

Item	Shielded Type	Ferrite Core	Length	Note

Note:

- (1) The support equipment was authorized by Declaration of Confirmation.
- (2) For detachable type I/O cable should be specified the length in cm in 『Length』 column.

3.5EQUIPMENTS LIST FOR ALL TEST ITEMS

Radiation Test equipment

Item	Equipment	Manufacturer	Type No.	Serial No.	Last calibration	Calibrated until
1	Spectrum Analyzer (9kHz-26.5GHz)	KEYSIGHT	9020A	MY45109572	Sep. 21, 2021	Sep. 20, 2022
2	Spectrum Analyzer (1GHz-40GHz)	Agilent	E4446A	100363	Sep. 21, 2021	Sep. 20, 2022
3	Test Receiver (9kHz-7GHz)	R&S	ESC17	101169	Sep. 21, 2021	Sep. 20, 2022
4	Bilog Antenna (30MHz-1400MHz)	Schwarzbeck	VULB9168	00877	Sep. 21, 2021	Sep. 20, 2022
5	Horn Antenna (1GHz-18GHz)	SCHWARZBEC K	BBHA9120D	1541	Sep. 21, 2021	Sep. 20, 2022
6	Horn Antenna (18GHz-40GHz)	A.H. System	SAS-574	588	Sep. 21, 2021	Sep. 20, 2022
7	Amplifier (30-1000MHz)	EM Electronics	EM330 Amplifier	N/A	Sep. 21, 2021	Sep. 20, 2022
8	Amplifier (1GHz-40GHz)	QUANJUDA	DLE-161	097	Sep. 21, 2021	Sep. 20, 2022
9	Loop Antenna (9KHz-30MHz)	SCHWARZBEC K	FMZB1519B	014	Sep. 21, 2021	Sep. 20, 2022
10	RF cables1 (9kHz-30MHz)	N/A	9kHz-30MHz	N/A	Sep. 21, 2021	Sep. 20, 2022
11	RF cables2 (30MHz-1GHz)	N/A	30MHz-1GHz	N/A	Sep. 21, 2021	Sep. 20, 2022
12	RF cables3 (1GHz-40GHz)	N/A	1GHz-40GHz	N/A	Sep. 21, 2021	Sep. 20, 2022
13	CMW500 Test	R&S	CMW500	106504	Sep. 21, 2021	Sep. 20, 2022
14	ESG Signal Generator	Agilent	E4421B	GB40051203	Sep. 21, 2021	Sep. 20, 2022
15	Signal Generator	Agilent	N5182A	MY47420215	Sep. 21, 2021	Sep. 20, 2022
16	D.C. Power Supply	LongWei	TPR-6405D	\	\	\
17	Software	Frad	EZ-EMC	FA-03A2 RE	\	\

Conduction Test equipment

Item	Kind of Equipment	Manufacturer	Type No.	Serial No.	Last calibration	Calibrated until
1	LISN	R&S	ENV216	101471	Sep. 21, 2021	Sep. 20, 2022
2	LISN	CYBERTEK	EM5040A	E1850400149	Sep. 21, 2021	Sep. 20, 2022
3	Test Cable	N/A	C01	N/A	Sep. 21, 2021	Sep. 20, 2022
4	Test Cable	N/A	C02	N/A	Sep. 21, 2021	Sep. 20, 2022
5	EMI Test Receiver	R&S	ESRP3	101946	Sep. 21, 2021	Sep. 20, 2022
6	Absorbing Clamp	DZ	ZN23201	N/A	Sep. 21, 2021	Sep. 20, 2022

4. EMC EMISSION TEST

4.1 CONDUCTED EMISSION MEASUREMENT

Test Requirement:	FCC Part15 C Section 15.207
Test Method:	ANSI C63.10:2013
Test Frequency Range:	150KHz to 30MHz
Receiver setup:	RBW=9KHz, VBW=30KHz, Sweep time=auto

4.1.1 POWER LINE CONDUCTED EMISSION LIMITS

FREQUENCY (MHz)	Limit (dBuV)		Standard
	Quasi-peak	Average	
0.15 -0.5	66 - 56 *	56 - 46 *	FCC
0.50 -5.0	56.00	46.00	FCC
5.0 -30.0	60.00	50.00	FCC

Note:

(1) *Decreases with the logarithm of the frequency.

4.1.2 TEST PROCEDURE

1. The equipment was set up as per the test configuration to simulate typical actual usage per the user's manual. The EUT is a tabletop system; a wooden table with a height of 0.8 meters is used and is placed on the ground plane as per ANSI C63.10:2013.
2. Support equipment, if needed, was placed as per ANSI C63.10:2013
3. All I/O cables were positioned to simulate typical actual usage as per ANSI C63.10:2013.
4. The adapter received AC120V/60Hz power through a Line Impedance Stabilization Network (LISN) which supplied power source and was grounded to the ground plane.
5. All support equipments received AC power from a second LISN, if any.
6. The EUT test program was started. Emissions were measured on each current carrying line of the EUT using a spectrum Analyzer / Receiver connected to the LISN powering the EUT. The LISN has two monitoring points: Line 1 (Hot Side) and Line 2 (Neutral Side). Two scans were taken: one with Line 1 connected to Analyzer / Receiver and Line 2 connected to a 50 ohm load; the second scan had Line 1 connected to a 50 ohm load and Line 2 connected to the Analyzer / Receiver.
7. Analyzer / Receiver scanned from 150 KHz to 30MHz for emissions in each of the test modes.e.
- 8 For the actual test configuration, please refer to the related Item –EUT Test Photos.

4.1.3 DEVIATION FROM TEST STANDARD

No deviation

4.1.4 TEST SETUP

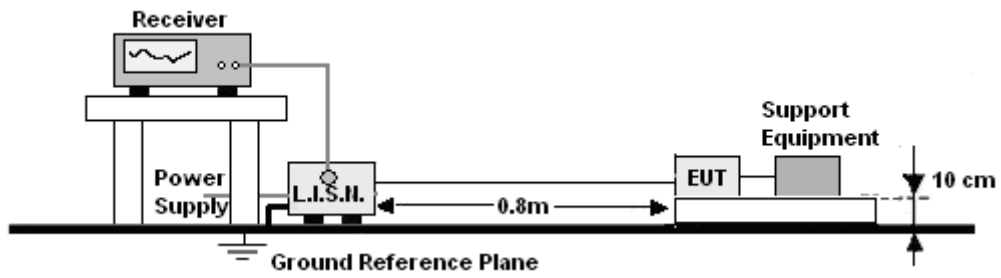

4.1.5 EUT OPERATING CONDITIONS

The EUT was configured for testing in a typical fashion (as a customer would normally use it). The EUT has been programmed to continuously transmit during test. This operating condition was tested and used to collect the included data.

We pretest AC 120V, the worst voltage was AC 120V and the data recording in the report.

4.1.6 TEST RESULT

Temperature :	26°C	Relative Humidity:	54%
Pressure :	101kPa	Phase :	L
Test Voltage :	AC 120V/60Hz		

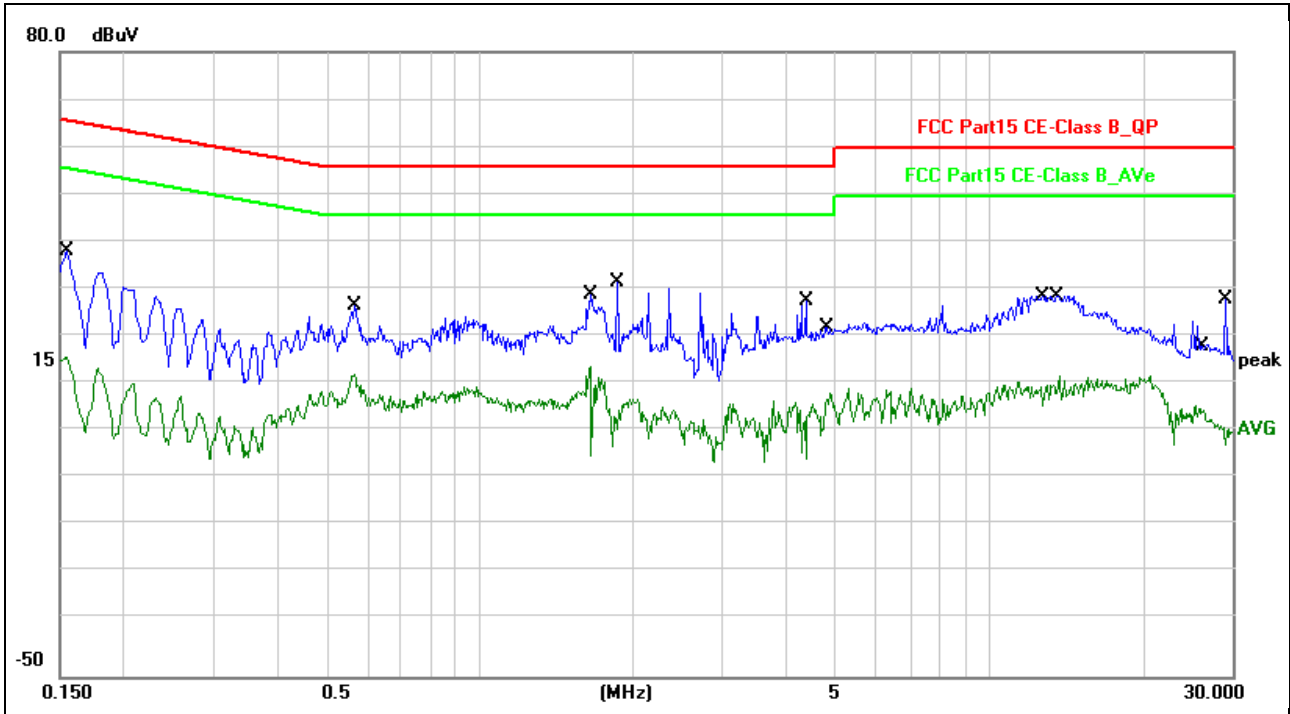

No.	Mk.	Freq. MHz	Reading Level dBuV	Correct Factor dB	Measure- ment dBuV	Limit dBuV	Over dB	Detector	Comment
1		0.1544	28.67	10.03	38.70	65.75	-27.05	QP	
2		0.1544	6.46	10.03	16.49	55.75	-39.26	AVG	
3		0.5685	17.29	10.03	27.32	56.00	-28.68	QP	
4		0.5685	2.83	10.03	12.86	46.00	-33.14	AVG	
5		1.6485	4.44	10.05	14.49	46.00	-31.51	AVG	
6	*	1.8600	22.02	10.05	32.07	56.00	-23.93	QP	
7		4.3665	18.02	10.08	28.10	56.00	-27.90	QP	
8		4.8570	-1.15	10.09	8.94	46.00	-37.06	AVG	
9		12.7500	18.99	10.15	29.14	60.00	-30.86	QP	
10		13.7355	2.29	10.15	12.44	50.00	-37.56	AVG	
11		26.1060	-4.31	10.11	5.80	50.00	-44.20	AVG	
12		29.1030	18.43	10.09	28.52	60.00	-31.48	QP	

Notes:

1. An initial pre-scan was performed on the line and neutral lines with peak detector.
2. Quasi-Peak and Average measurement were performed at the frequencies with maximized peak emission.
3. Measurement Level = Reading level + Correct Factor

Temperature :	26°C	Relative Humidity:	54%
Pressure :	101kPa	Phase :	N
Test Voltage :	AC 120V/60Hz		

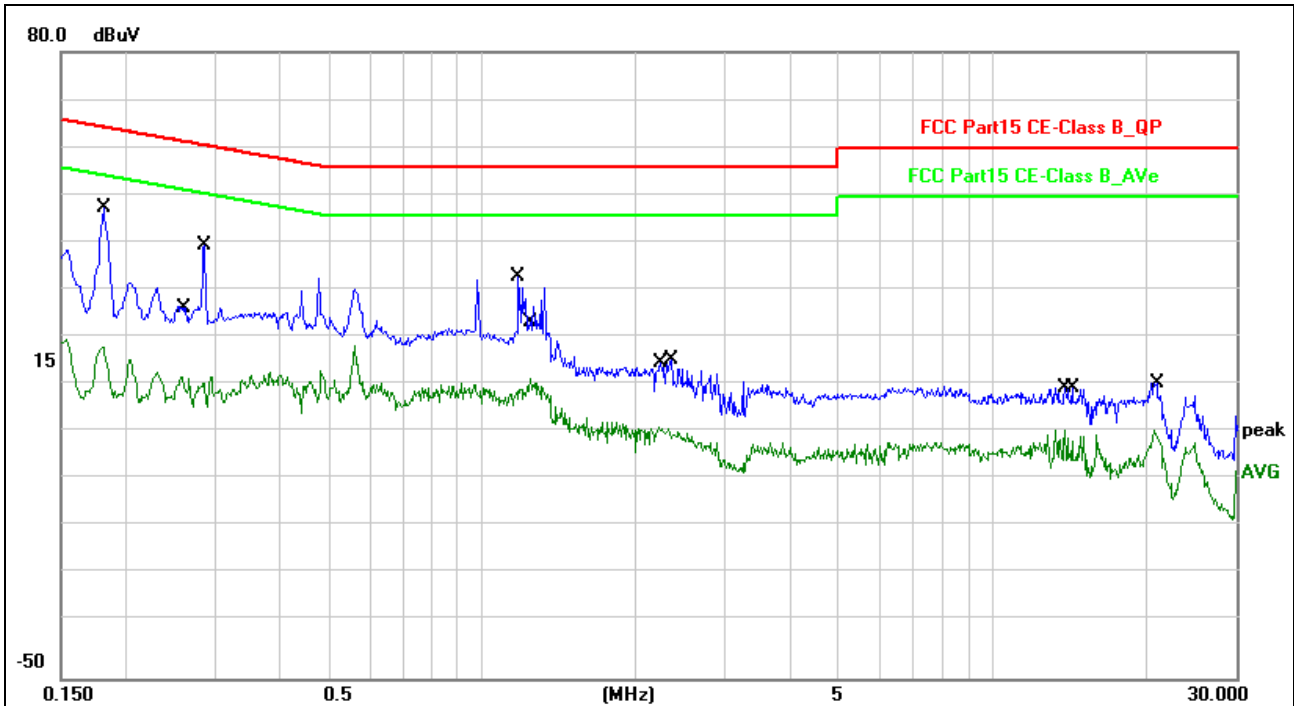

No.	Mk.	Freq. MHz	Reading Level dBuV	Correct Factor dB	Measure- ment dBuV	Limit dBuV	Over dB	Detector	Comment
1	*	0.1814	37.76	10.00	47.76	64.42	-16.66	QP	
2		0.1814	8.90	10.00	18.90	54.42	-35.52	AVG	
3		0.2580	2.48	10.00	12.48	51.49	-39.01	AVG	
4		0.2847	29.74	10.00	39.74	60.68	-20.94	QP	
5		1.1805	23.41	10.01	33.42	56.00	-22.58	QP	
6		1.2435	2.32	10.01	12.33	46.00	-33.67	AVG	
7		2.2334	-7.86	10.02	2.16	46.00	-43.84	AVG	
8		2.3549	6.12	10.02	16.14	56.00	-39.86	QP	
9		13.9062	-8.54	10.11	1.57	50.00	-48.43	AVG	
10		14.3070	0.20	10.12	10.32	60.00	-49.68	QP	
11		20.7912	-8.74	10.11	1.37	50.00	-48.63	AVG	
12		20.9939	1.24	10.11	11.35	60.00	-48.65	QP	

Notes:

- 1.An initial pre-scan was performed on the line and neutral lines with peak detector.
- 2.Quasi-Peak and Average measurement were performed at the frequencies with maximized peak emission.
- 3.Measurement Level = Reading level + Correct Factor

4.2 RADIATED EMISSION MEASUREMENT

Test Requirement:	FCC Part15 C Section 15.209				
Test Method:	ANSI C63.10:2013				
Test Frequency Range:	9kHz to 25GHz				
Test site:	Measurement Distance: 3m				
Receiver setup:	Frequency	Detector	RBW	VBW	Value
	9KHz-150KHz	Quasi-peak	200Hz	600Hz	Quasi-peak
	150KHz-30MHz	Quasi-peak	9KHz	30KHz	Quasi-peak
	30MHz-1GHz	Quasi-peak	120KHz	300KHz	Quasi-peak
	Above 1GHz	Peak	1MHz	3MHz	Peak
		Peak	1MHz	10Hz	Average

4.2.1 RADIATED EMISSION LIMITS

Frequencies (MHz)	Field Strength (micorvolts/meter)	Measurement Distance (meters)
0.009~0.490	2400/F(KHz)	300
0.490~1.705	24000/F(KHz)	30
1.705~30.0	30	30
30~88	100	3
88~216	150	3
216~960	200	3
Above 960	500	3

LIMITS OF RADIATED EMISSION MEASUREMENT

FREQUENCY (MHz)	Limit (dBuV/m) (at 3M)	
	PEAK	AVERAGE
Above 1000	74	54

Notes:

- (1) The limit for radiated test was performed according to FCC PART 15C.
- (2) The tighter limit applies at the band edges.
- (3) Emission level (dBuV/m)=20log Emission level (uV/m).

4.2.2 TEST PROCEDURE

Below 1GHz test procedure as below:

- a. The EUT was placed on the top of a rotating table 0.1 meters above the ground at a 3 meter semi-anechoic chamber. The table was rotated 360 degrees to determine the position of the highest radiation.
- b. The EUT was set 3 meters away from the interference-receiving antenna, which was mounted on the top of a variable-height antenna tower.
- c. The antenna height is varied from one meter to four meters above the ground to determine the maximum value of the field strength. Both horizontal and vertical polarizations of the antenna are set to make the measurement.
- d. For each suspected emission, the EUT was arranged to its worst case and then the antenna was tuned to heights from 1 meter to 4 meters (for the test frequency of below 30MHz, the antenna was tuned to heights 1 meter) and the rotatable table was turned from 0 degrees to 360 degrees to find the maximum reading.
- e. The test-receiver system was set to Peak Detect Function and Specified Bandwidth with Maximum Hold Mode.
- f. If the emission level of the EUT in peak mode was 10dB lower than the limit specified, then testing could be stopped and the peak values of the EUT would be reported. Otherwise the emissions that did not have 10dB margin would be re-tested one by one using peak, quasi-peak or average method as specified and then reported in a data sheet.

Above 1GHz test procedure as below:

- g. Different between above is the test site, change from Semi- Anechoic Chamber to fully Anechoic Chamber and change from table 0.8 metre to 1.5 metre (Above 18GHz the distance is 1 meter and table is 1.5 metre).
- h. Test the EUT in the lowest channel, the middle channel, the Highest channel
Note:
Both horizontal and vertical antenna polarities were tested
and performed pretest to three orthogonal axis. The worst case emissions were reported

4.2.3 DEVIATION FROM TEST STANDARD

No deviation

4.2.4 TEST SETUP

(A) Radiated Emission Test-Up Frequency Below 30MHz

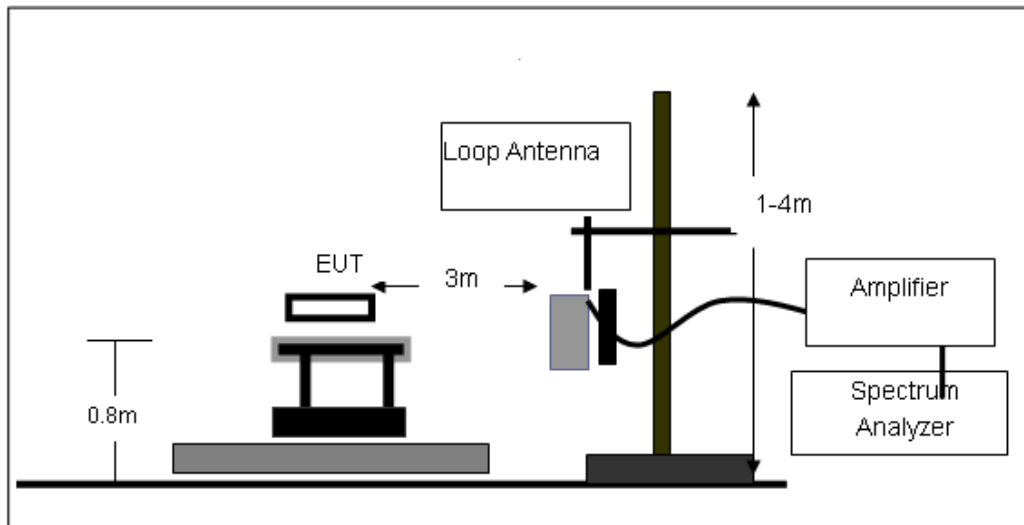

(B) Radiated Emission Test-Up Frequency 30MHz~1GHz

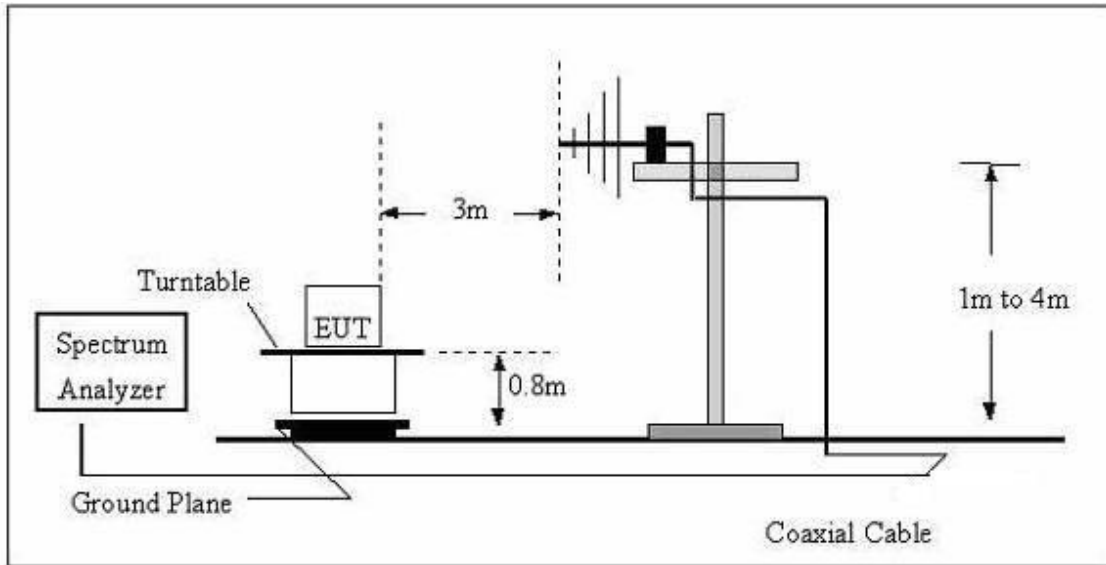

(C) Radiated Emission Test-Up Frequency Above 1GHz

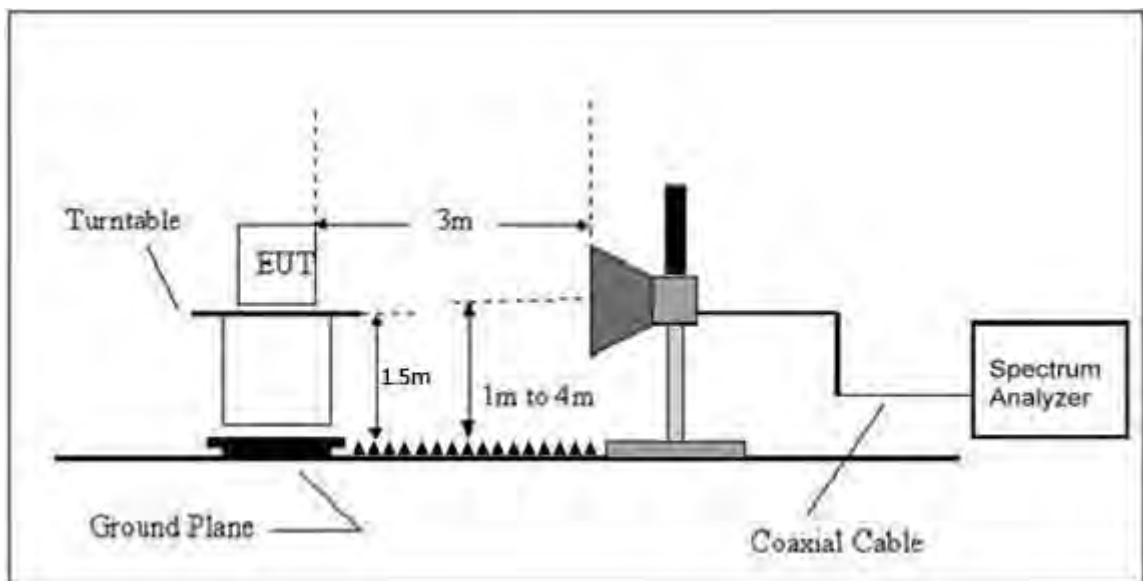

4.2.5 EUT OPERATING CONDITIONS

The EUT tested system was configured as the statements of 2.4 Unless otherwise a special operating condition is specified in the follows during the testing.

4.2.6 TEST RESULTS

Between 9KHz – 30MHz

The emission from 9 kHz to 30MHz was pre-tested and found the result was 20dB lower than the limit, and according to 15.31(o) & RSS-Gen 6.13, the test result no need to reported.

Between 30MHz – 1GHz

Temperature:	26°C	Relative Humidity:	54%
Pressure:	101 kPa	Polarization:	Horizontal
Test Voltage:	AC 120V/60Hz		

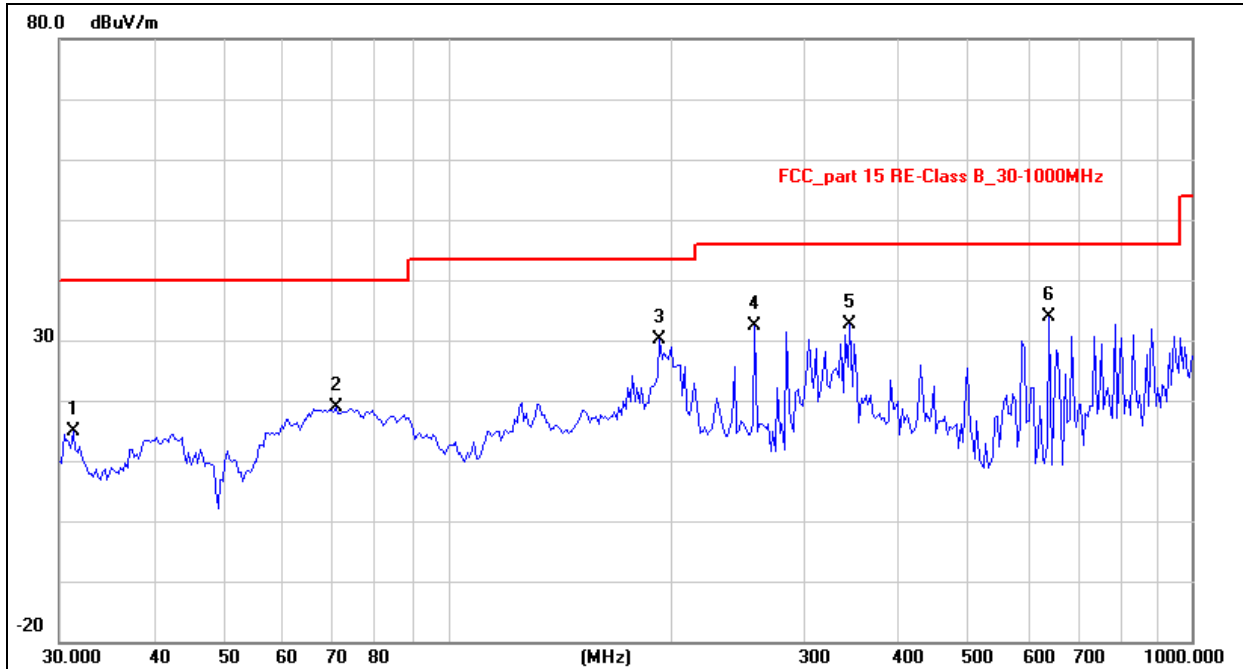

No.	Mk.	Freq. MHz	Reading Level dBuV	Correct Factor dB/m	Measure- ment dBuV/m	Limit dBuV/m	Over dB	Antenna Height cm	Table Degree	Comment
1		31.2892	31.89	-17.11	14.78	40.00	-25.22	QP	100	130
2		70.5835	37.56	-18.77	18.79	40.00	-21.21	QP	100	130
3		192.4183	49.05	-18.90	30.15	43.50	-13.35	QP	100	130
4		258.3263	49.35	-17.04	32.31	46.00	-13.69	QP	100	130
5		346.8091	46.95	-14.41	32.54	46.00	-13.46	QP	100	130
6	*	642.8612	41.13	-7.17	33.96	46.00	-12.04	QP	100	130

Temperature:	26°C	Relative Humidity:	54%
Pressure:	101kPa	Polarization:	Vertical
Test Voltage:	AC 120V/60Hz		

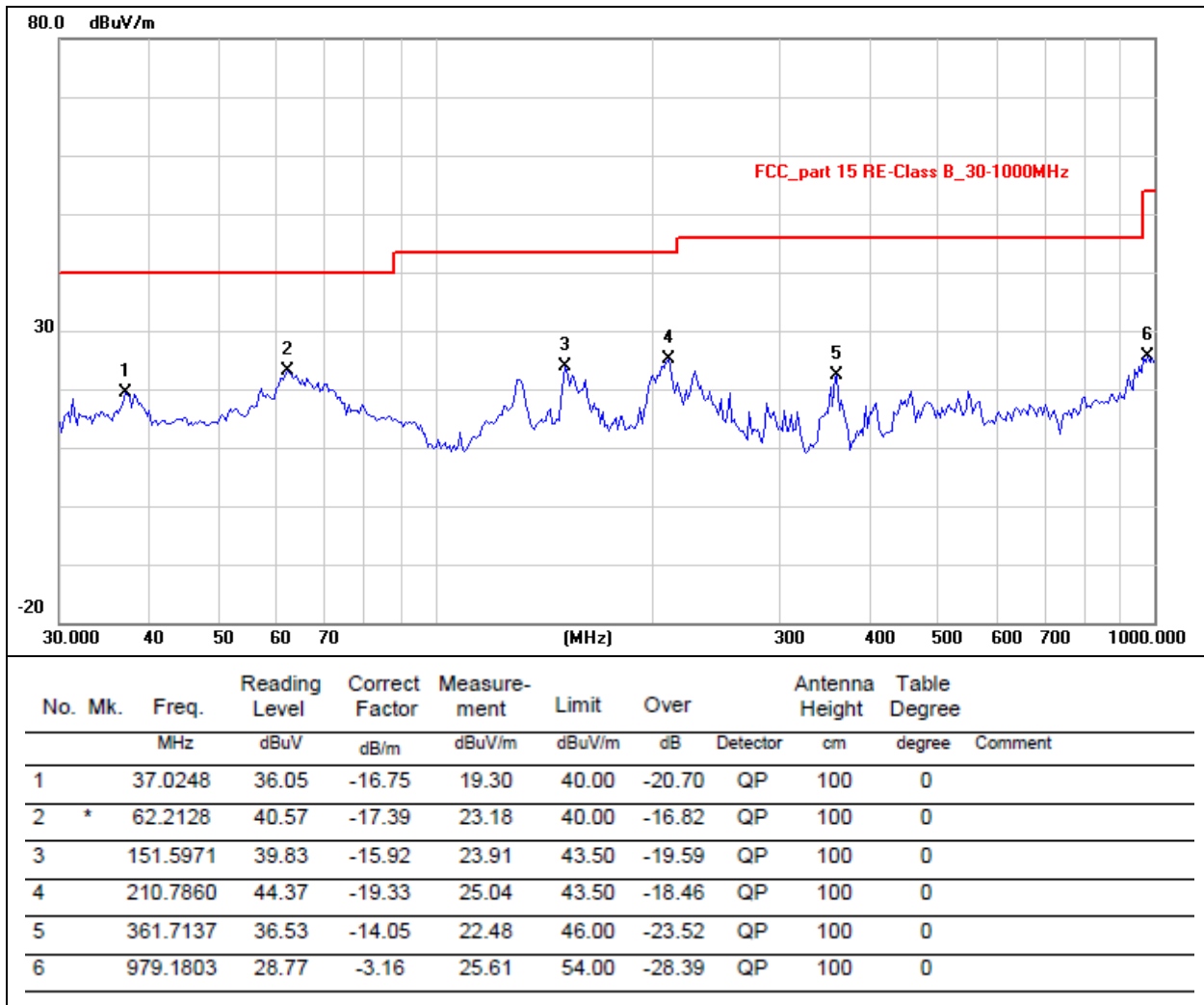

Remarks:

1. Final Level = Receiver Read level + Antenna Factor + Cable Loss – Preamplifier Factor
2. The emission levels of other frequencies are very lower than the limit and not show in test report.
3. The test data shows only the worst case 802.11b mode

1GHz~25GHz

802.11b

Polar (H/V)	Frequency	Meter Reading	Pre-ampl ifier	Cable Loss	Antenna Factor	Emission Level	Limits	Margin	Detect or Type
	(MHz)	(dBuV)	(dB)	(dB)	(dB)	(dBuV/m)	(dBuV/m)	(dB)	
Low Channel:2412MHz									
V	4824	55.68	30.55	5.77	24.66	55.56	74.00	-18.44	PK
V	4824	44.40	30.55	5.77	24.66	44.28	54.00	-9.72	AV
V	7236	56.27	30.33	6.32	24.55	56.81	74.00	-17.19	PK
V	7236	47.34	30.33	6.32	24.55	47.88	54.00	-6.12	AV
V	9648	44.41	30.85	7.45	24.69	45.70	74.00	-28.30	PK
V	9648	45.41	30.85	7.45	24.69	46.70	54.00	-7.30	AV
H	4824	46.29	31.02	8.99	25.57	49.83	74.00	-24.17	PK
H	4824	44.92	31.02	8.99	25.57	48.46	54.00	-5.54	AV
H	7236	46.49	30.55	5.77	24.66	46.37	74.00	-27.63	PK
H	7236	46.29	30.55	5.77	24.66	46.17	54.00	-7.83	AV
H	9648	43.93	30.33	6.32	24.55	44.47	74.00	-29.53	PK
H	9648	44.65	30.33	6.32	24.55	45.19	54.00	-8.81	AV

Polar (H/V)	Frequency	Meter Reading	Pre-ampl ifier	Cable Loss	Antenna Factor	Emission Level	Limits	Margin	Detect or Type
	(MHz)	(dBuV)	(dB)	(dB)	(dB)	(dBuV/m)	(dBuV/m)	(dB)	
Middle Channel:2437MHz									
V	4874	56.06	30.55	5.77	24.66	55.94	74.00	-18.06	PK
V	4874	43.16	30.55	5.77	24.66	43.04	54.00	-10.96	AV
V	7311	55.13	30.33	6.32	24.55	55.67	74.00	-18.33	PK
V	7311	47.07	30.33	6.32	24.55	47.61	54.00	-6.39	AV
V	9748	45.90	30.85	7.45	24.69	47.19	74.00	-26.81	PK
V	9748	44.84	30.85	7.45	24.69	46.13	54.00	-7.87	AV
H	4874	45.31	31.02	8.99	25.57	48.85	74.00	-25.15	PK
H	4874	45.26	31.02	8.99	25.57	48.80	54.00	-5.20	AV
H	7311	44.07	30.55	5.77	24.66	43.95	74.00	-30.05	PK
H	7311	45.79	30.55	5.77	24.66	45.67	54.00	-8.33	AV
H	9748	46.44	30.33	6.32	24.55	46.98	74.00	-27.02	PK
H	9748	46.37	30.33	6.32	24.55	46.91	54.00	-7.09	AV

Polar (H/V)	Frequency	Meter Reading	Pre-ampl ifier	Cable Loss	Antenna Factor	Emission Level	Limits	Margin	Detect or Type
	(MHz)	(dBuV)	(dB)	(dB)	(dB)	(dBuV/m)	(dBuV/m)	(dB)	
High Channel:2462MHz									
V	4924	57.53	30.55	5.77	24.66	57.41	74.00	-16.59	PK
V	4924	43.89	30.55	5.77	24.66	43.77	54.00	-10.23	AV
V	7386	56.79	30.33	6.32	24.55	57.33	74.00	-16.67	PK
V	7386	46.30	30.33	6.32	24.55	46.84	54.00	-7.16	AV
V	9848	46.23	30.85	7.45	24.69	47.52	74.00	-26.48	PK
V	9848	43.97	30.85	7.45	24.69	45.26	54.00	-8.74	AV
H	4924	45.89	31.02	8.99	25.57	49.43	74.00	-24.57	PK
H	4924	46.02	31.02	8.99	25.57	49.56	54.00	-4.44	AV

H	7386	43.86	30.55	5.77	24.66	43.74	74.00	-30.26	PK
H	7386	46.38	30.55	5.77	24.66	46.26	54.00	-7.74	AV
H	9848	44.12	30.33	6.32	24.55	44.66	74.00	-29.34	PK
H	9848	44.73	30.33	6.32	24.55	45.27	54.00	-8.73	AV

Remark:

1. Emission Level = Meter Reading + Antenna Factor + Cable Loss – Pre-amplifier, Margin= Emission Level - Limit
2. If peak below the average limit, the average emission was no test.
3. The amplitude of spurious emissions which are attenuated by more than 20dB below the permissible value has no need to be reported.

802.11g

Polar (H/V)	Frequency	Meter Reading	Pre-amplifier	Cable Loss	Antenna Factor	Emission Level	Limits	Margin	Detect or Type
	(MHz)	(dBuV)	(dB)	(dB)	(dB)	(dBuV/m)	(dBuV/m)	(dB)	
Low Channel:2412MHz									
V	4824	57.95	30.55	5.77	24.66	57.83	74.00	-16.17	PK
V	4824	42.60	30.55	5.77	24.66	42.48	54.00	-11.52	AV
V	7236	55.36	30.33	6.32	24.55	55.90	74.00	-18.10	PK
V	7236	44.62	30.33	6.32	24.55	45.16	54.00	-8.84	AV
V	9648	46.42	30.85	7.45	24.69	47.71	74.00	-26.29	PK
V	9648	44.04	30.85	7.45	24.69	45.33	54.00	-8.67	AV
H	4824	43.91	31.02	8.99	25.57	47.45	74.00	-26.55	PK
H	4824	45.35	31.02	8.99	25.57	48.89	54.00	-5.11	AV
H	7236	44.84	30.55	5.77	24.66	44.72	74.00	-29.28	PK
H	7236	44.29	30.55	5.77	24.66	44.17	54.00	-9.83	AV
H	9648	45.58	30.33	6.32	24.55	46.12	74.00	-27.88	PK
H	9648	43.69	30.33	6.32	24.55	44.23	54.00	-9.77	AV

Polar (H/V)	Frequency	Meter Reading	Pre-amplifier	Cable Loss	Antenna Factor	Emission Level	Limits	Margin	Detect or Type
	(MHz)	(dBuV)	(dB)	(dB)	(dB)	(dBuV/m)	(dBuV/m)	(dB)	
Middle Channel:2437MHz									
V	4874	53.59	30.55	5.77	24.66	53.47	74.00	-20.53	PK
V	4874	43.24	30.55	5.77	24.66	43.12	54.00	-10.88	AV
V	7311	55.64	30.33	6.32	24.55	56.18	74.00	-17.82	PK
V	7311	44.85	30.33	6.32	24.55	45.39	54.00	-8.61	AV
V	9748	46.01	30.85	7.45	24.69	47.30	74.00	-26.70	PK
V	9748	46.03	30.85	7.45	24.69	47.32	54.00	-6.68	AV
H	4874	45.00	31.02	8.99	25.57	48.54	74.00	-25.46	PK
H	4874	45.94	31.02	8.99	25.57	49.48	54.00	-4.52	AV
H	7311	46.11	30.55	5.77	24.66	45.99	74.00	-28.01	PK
H	7311	45.64	30.55	5.77	24.66	45.52	54.00	-8.48	AV
H	9748	45.40	30.33	6.32	24.55	45.94	74.00	-28.06	PK
H	9748	43.94	30.33	6.32	24.55	44.48	54.00	-9.52	AV

Polar (H/V)	Frequency	Meter Reading	Pre-amplifier	Cable Loss	Antenna Factor	Emission Level	Limits	Margin	Detect or Type
	(MHz)	(dBuV)	(dB)	(dB)	(dB)	(dBuV/m)	(dBuV/m)	(dB)	
High Channel:2462MHz									
V	4924	52.70	30.55	5.77	24.66	52.58	74.00	-21.42	PK
V	4924	43.54	30.55	5.77	24.66	43.42	54.00	-10.58	AV
V	7386	56.38	30.33	6.32	24.55	56.92	74.00	-17.08	PK
V	7386	45.45	30.33	6.32	24.55	45.99	54.00	-8.01	AV
V	9848	44.51	30.85	7.45	24.69	45.80	74.00	-28.20	PK
V	9848	45.94	30.85	7.45	24.69	47.23	54.00	-6.77	AV
H	4924	45.02	31.02	8.99	25.57	48.56	74.00	-25.44	PK
H	4924	44.24	31.02	8.99	25.57	47.78	54.00	-6.22	AV
H	7386	45.39	30.55	5.77	24.66	45.27	74.00	-28.73	PK
H	7386	44.06	30.55	5.77	24.66	43.94	54.00	-10.06	AV
H	9848	46.59	30.33	6.32	24.55	47.13	74.00	-26.87	PK
H	9848	45.05	30.33	6.32	24.55	45.59	54.00	-8.41	AV

Remark:

1. Emission Level = Meter Reading + Antenna Factor + Cable Loss – Pre-amplifier, Margin= Emission Level - Limit
2. If peak below the average limit, the average emission was no test.
3. The amplitude of spurious emissions which are attenuated by more than 20dB below the permissible value has no need to be reported.

802.11n20

Polar (H/V)	Frequency	Meter Reading	Pre-amplifier	Cable Loss	Antenna Factor	Emission Level	Limits	Margin	Detect or Type
	(MHz)	(dBuV)	(dB)	(dB)	(dB)	(dBuV/m)	(dBuV/m)	(dB)	
Low Channel:2412MHz									
V	4824	57.48	30.55	5.77	24.66	57.36	74.00	-16.64	PK
V	4824	43.52	30.55	5.77	24.66	43.40	54.00	-10.60	AV
V	7236	57.57	30.33	6.32	24.55	58.11	74.00	-15.89	PK
V	7236	44.77	30.33	6.32	24.55	45.31	54.00	-8.69	AV
V	9648	45.97	30.85	7.45	24.69	47.26	74.00	-26.74	PK
V	9648	44.85	30.85	7.45	24.69	46.14	54.00	-7.86	AV
H	4824	44.76	31.02	8.99	25.57	48.30	74.00	-25.70	PK
H	4824	43.77	31.02	8.99	25.57	47.31	54.00	-6.69	AV
H	7236	46.26	30.55	5.77	24.66	46.14	74.00	-27.86	PK
H	7236	45.59	30.55	5.77	24.66	45.47	54.00	-8.53	AV
H	9648	46.08	30.33	6.32	24.55	46.62	74.00	-27.38	PK
H	9648	44.20	30.33	6.32	24.55	44.74	54.00	-9.26	AV

Polar (H/V)	Frequency	Meter Reading	Pre-amplifier	Cable Loss	Antenna Factor	Emission Level	Limits	Margin	Detect or Type
	(MHz)	(dBuV)	(dB)	(dB)	(dB)	(dBuV/m)	(dBuV/m)	(dB)	
Middle Channel:2437MHz									
V	4874	58.33	30.55	5.77	24.66	58.21	74.00	-15.79	PK
V	4874	44.78	30.55	5.77	24.66	44.66	54.00	-9.34	AV
V	7311	56.01	30.33	6.32	24.55	56.55	74.00	-17.45	PK
V	7311	45.01	30.33	6.32	24.55	45.55	54.00	-8.45	AV
V	9748	45.51	30.85	7.45	24.69	46.80	74.00	-27.20	PK
V	9748	45.18	30.85	7.45	24.69	46.47	54.00	-7.53	AV

H	4874	43.78	31.02	8.99	25.57	47.32	74.00	-26.68	PK
H	4874	45.31	31.02	8.99	25.57	48.85	54.00	-5.15	AV
H	7311	44.45	30.55	5.77	24.66	44.33	74.00	-29.67	PK
H	7311	44.29	30.55	5.77	24.66	44.17	54.00	-9.83	AV
H	9748	45.17	30.33	6.32	24.55	45.71	74.00	-28.29	PK
H	9748	46.56	30.33	6.32	24.55	47.10	54.00	-6.90	AV

Polar (H/V)	Frequency	Meter Reading	Pre-ampl ifier	Cable Loss	Antenna Factor	Emission Level	Limits	Margin	Detect or Type
	(MHz)	(dBuV)	(dB)	(dB)	(dB)	(dBuV/m)	(dBuV/ m)	(dB)	
High Channel:2462MHz									
V	4924	55.41	30.55	5.77	24.66	55.29	74.00	-18.71	PK
V	4924	45.23	30.55	5.77	24.66	45.11	54.00	-8.89	AV
V	7386	56.31	30.33	6.32	24.55	56.85	74.00	-17.15	PK
V	7386	47.13	30.33	6.32	24.55	47.67	54.00	-6.33	AV
V	9848	45.71	30.85	7.45	24.69	47.00	74.00	-27.00	PK
V	9848	45.26	30.85	7.45	24.69	46.55	54.00	-7.45	AV
H	4924	44.44	31.02	8.99	25.57	47.98	74.00	-26.02	PK
H	4924	43.62	31.02	8.99	25.57	47.16	54.00	-6.84	AV
H	7386	43.96	30.55	5.77	24.66	43.84	74.00	-30.16	PK
H	7386	44.14	30.55	5.77	24.66	44.02	54.00	-9.98	AV
H	9848	45.33	30.33	6.32	24.55	45.87	74.00	-28.13	PK
H	9848	44.50	30.33	6.32	24.55	45.04	54.00	-8.96	AV

Remark:

1. Emission Level = Meter Reading + Antenna Factor + Cable Loss – Pre-amplifier,
Margin= Emission Level - Limit
2. If peak below the average limit, the average emission was no test.
3. The amplitude of spurious emissions which are attenuated by more than 20dB below the permissible value has no need to be reported.

5. RADIATED BAND EMISSION MEASUREMENT

5.1 TEST REQUIREMENT:

Test Requirement:	FCC Part15 C Section 15.209 and 15.205				
Test Method:	ANSI C63.10: 2013				
Test Frequency Range:	All of the restrict bands were tested, only the worst band's (2310MHz to 2500MHz) data was showed.				
Test site:	Measurement Distance: 3m				
Receiver setup:	Frequency	Detector	RBW	VBW	Value
	Above 1GHz	Peak	1MHz	3MHz	Peak
		Average	1MHz	3MHz	Average

LIMITS OF RADIATED EMISSION MEASUREMENT (Above 1000MHz)

FREQUENCY (MHz)	Class B (dBuV/m) (at 3M)	
	PEAK	AVERAGE
Above 1000	74	54

Notes:

- (1) The limit for radiated test was performed according to FCC PART 15C.
- (2) The tighter limit applies at the band edges.
- (3) Emission level (dBuV/m)=20log Emission level (uV/m).

5.2 TEST PROCEDURE

Above 1GHz test procedure as below:

- a. 1. The EUT was placed on the top of a rotating table 1.5 meters above the ground at a 3 meter camber. The table was rotated 360 degrees to determine the position of the highest radiation.
- b. The EUT was set 3 meters away from the interference-receiving antenna, which was mounted on the top of a variable-height antenna tower.
- c. The antenna height is varied from one meter to four meters above the ground to determine the maximum value of the field strength. Both horizontal and vertical polarizations of the antenna are set to make the measurement.
- d. For each suspected emission, the EUT was arranged to its worst case and then the antenna was tuned to heights from 1 meter to 4 meters and the rota table was turned from 0 degrees to 360 degrees to find the maximum reading.
- e. The test-receiver system was set to Peak Detect Function and Specified Bandwidth with Maximum Hold Mode.

f. If the emission level of the EUT in peak mode was 10dB lower than the limit specified, then testing could be stopped and the peak values of the EUT would be reported. Otherwise the emissions that did not have 10dB margin would be re-tested one by one using peak, quasi-peak or average method as specified and then reported in a data sheet.

g. Test the EUT in the lowest channel, the Highest channel

Note:

Both horizontal and vertical antenna polarities were tested

and performed pretest to three orthogonal axis. The worst case emissions were reported

5.3 DEVIATION FROM TEST STANDARD

No deviation

5.4 TEST SETUP

Radiated Emission Test-Up Frequency Above 1GHz

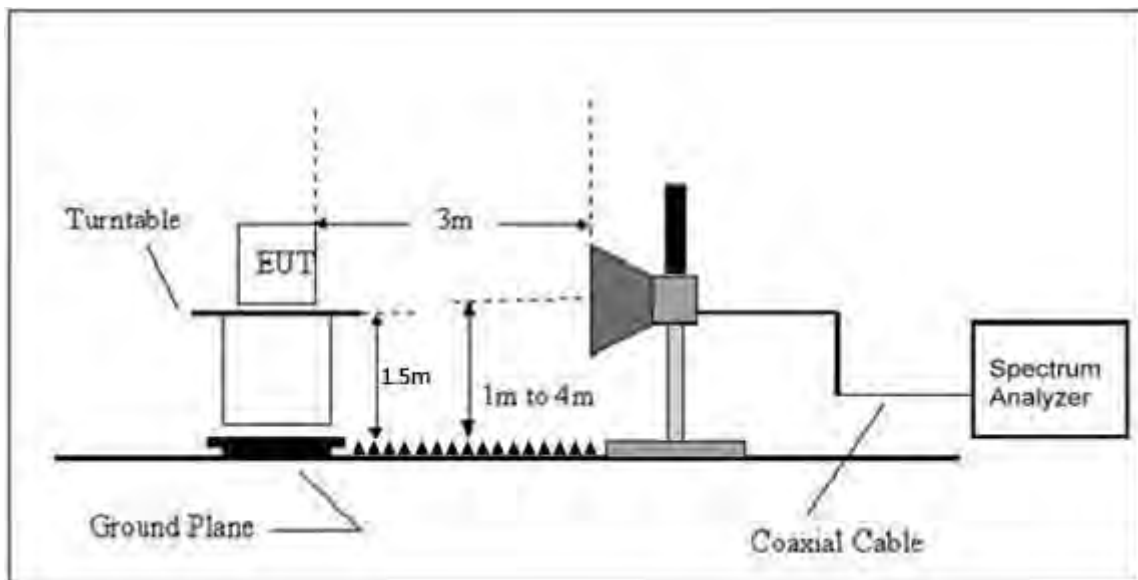

5.5 EUT OPERATING CONDITIONS

The EUT tested system was configured as the statements of 2.3 Unless otherwise a special operating condition is specified in the follows during the testing.

5.6 TEST RESULT

	Polar (H/V)	Frequenc y (MHz)	Meter Reading (dBuV)	Pre-amplifier (dB)	Cable Loss (dB)	Antenna Factor (dB/m)	Emission level (dBuV/m)	Limit (dBuV /m)	Detec tor Type	Result
802.11b	LowChannel 2412MHz									
	H	2390.00	55.39	30.22	4.85	23.98	54.00	74.00	PK	PASS
	H	2390.00	45.43	30.22	4.85	23.98	44.04	54.00	AV	PASS
	H	2400.00	56.44	30.22	4.85	23.98	55.05	74.00	PK	PASS
	H	2400.00	47.21	30.22	4.85	23.98	45.82	54.00	AV	PASS
	V	2390.00	55.69	30.22	4.85	23.98	54.30	74.00	PK	PASS
	V	2390.00	42.62	30.22	4.85	23.98	41.23	54.00	AV	PASS
	V	2400.00	56.75	30.22	4.85	23.98	55.36	74.00	PK	PASS
	V	2400.00	46.03	30.22	4.85	23.98	44.64	54.00	AV	PASS
	HighChannel 2462MHz									
	H	2483.50	56.97	30.22	4.85	23.98	55.58	74.00	PK	PASS
	H	2485.50	44.07	30.22	4.85	23.98	42.68	54.00	AV	PASS
	H	2500.00	54.98	30.22	4.85	23.98	53.59	74.00	PK	PASS
	H	2500.00	45.50	30.22	4.85	23.98	44.11	54.00	AV	PASS
	V	2483.50	57.89	30.22	4.85	23.98	56.50	74.00	PK	PASS
	V	2485.50	44.45	30.22	4.85	23.98	43.06	54.00	AV	PASS
	V	2500.00	57.34	30.22	4.85	23.98	55.95	74.00	PK	PASS
	V	2500.00	46.42	30.22	4.85	23.98	45.03	54.00	AV	PASS

802.11g	LowChannel 2412MHz									
	H	2390.00	57.41	30.22	4.85	23.98	56.02	74.00	PK	PASS
	H	2390.00	44.03	30.22	4.85	23.98	42.64	54.00	AV	PASS
	H	2400.00	57.23	30.22	4.85	23.98	55.84	74.00	PK	PASS
	H	2400.00	45.57	30.22	4.85	23.98	44.18	54.00	AV	PASS
	V	2390.00	53.55	30.22	4.85	23.98	52.16	74.00	PK	PASS
	V	2390.00	42.95	30.22	4.85	23.98	41.56	54.00	AV	PASS
	V	2400.00	57.00	30.22	4.85	23.98	55.61	74.00	PK	PASS
	V	2400.00	46.86	30.22	4.85	23.98	45.47	54.00	AV	PASS
	High Channel 2462MHz									
	H	2483.50	52.96	30.22	4.85	23.98	51.57	74.00	PK	PASS
	H	2485.50	42.93	30.22	4.85	23.98	41.54	54.00	AV	PASS
	H	2500.00	55.18	30.22	4.85	23.98	53.79	74.00	PK	PASS
	H	2500.00	45.18	30.22	4.85	23.98	43.79	54.00	AV	PASS
	V	2483.50	58.58	30.22	4.85	23.98	57.19	74.00	PK	PASS
	V	2485.50	45.12	30.22	4.85	23.98	43.73	54.00	AV	PASS
	V	2500.00	55.83	30.22	4.85	23.98	54.44	74.00	PK	PASS
	V	2500.00	44.73	30.22	4.85	23.98	43.34	54.00	AV	PASS

		LowChannel 2412MHz									
		H	2390.00	54.42	30.22	4.85	23.98	53.03	74.00	PK	PASS
802.11 n20	H	2390.00	44.97	30.22	4.85	23.98	43.58	54.00	AV	PASS	
	H	2400.00	56.09	30.22	4.85	23.98	54.70	74.00	PK	PASS	
	H	2400.00	46.10	30.22	4.85	23.98	44.71	54.00	AV	PASS	
	V	2390.00	55.44	30.22	4.85	23.98	54.05	74.00	PK	PASS	
	V	2390.00	45.58	30.22	4.85	23.98	44.19	54.00	AV	PASS	
	V	2400.00	56.90	30.22	4.85	23.98	55.51	74.00	PK	PASS	
	V	2400.00	47.01	30.22	4.85	23.98	45.62	54.00	AV	PASS	
			High Channel 2462MHz								
	H	2483.50	53.48	30.22	4.85	23.98	52.09	74.00	PK	PASS	
	H	2485.50	43.83	30.22	4.85	23.98	42.44	54.00	AV	PASS	
	H	2500.00	56.71	30.22	4.85	23.98	55.32	74.00	PK	PASS	
	H	2500.00	46.39	30.22	4.85	23.98	45.00	54.00	AV	PASS	
	V	2483.50	55.12	30.22	4.85	23.98	53.73	74.00	PK	PASS	
	V	2485.50	45.56	30.22	4.85	23.98	44.17	54.00	AV	PASS	
	V	2500.00	55.77	30.22	4.85	23.98	54.38	74.00	PK	PASS	
	V	2500.00	45.70	30.22	4.85	23.98	44.31	54.00	AV	PASS	

Remark:

1. Emission Level = Meter Reading + Antenna Factor + Cable Loss – Pre-amplifier, Margin= Emission Level - Limit

6. POWER SPECTRAL DENSITY TEST

Test Requirement:	FCC Part15 C Section 15.247 (e)
Test Method:	KDB558074 D0115.247 Meas Guidancev05r02

6.1 APPLIED PROCEDURES / LIMIT

FCC Part15 (15.247) , Subpart C				
Section	Test Item	Limit	Frequency Range (MHz)	Result
15.247	Power Spectral Density	8dBm/3kHz	2400-2483.5	PASS

6.2 TEST PROCEDURE

1. Set analyzer center frequency to DTS channel center frequency.
2. Set the span to 1.5 times the DTS bandwidth.
3. Set the RBW to: $3 \text{ kHz} \leq \text{RBW} \leq 100 \text{ kHz}$.
4. Set the VBW $\geq 3 \times \text{RBW}$.
5. Detector = peak.
6. Sweep time = auto couple.
7. Trace mode = max hold.
8. Allow trace to fully stabilize.
9. Use the peak marker function to determine the maximum amplitude level within the RBW.
10. If measured value exceeds limit, reduce RBW (no less than 3 kHz) and repeat.

6.3 DEVIATION FROM STANDARD

No deviation.

6.4 TEST SETUP



6.5 EUT OPERATION CONDITIONS

The EUT tested system was configured as the statements of 2.1 Unless otherwise a special operating condition is specified in the follows during the testing.

6.6 TEST RESULT

Temperature :	26°C	Relative Humidity :	54%
Pressure :	101kPa	Test Voltage :	DC 7.4V
Test Mode :	TX b Mode		

Frequency	Power Spectral Density (dBm/3kHz)	Limit (dBm/3kHz)	Result
2412 MHz	-19.229	8	PASS
2437 MHz	-20.640	8	PASS
2462 MHz	-18.411	8	PASS

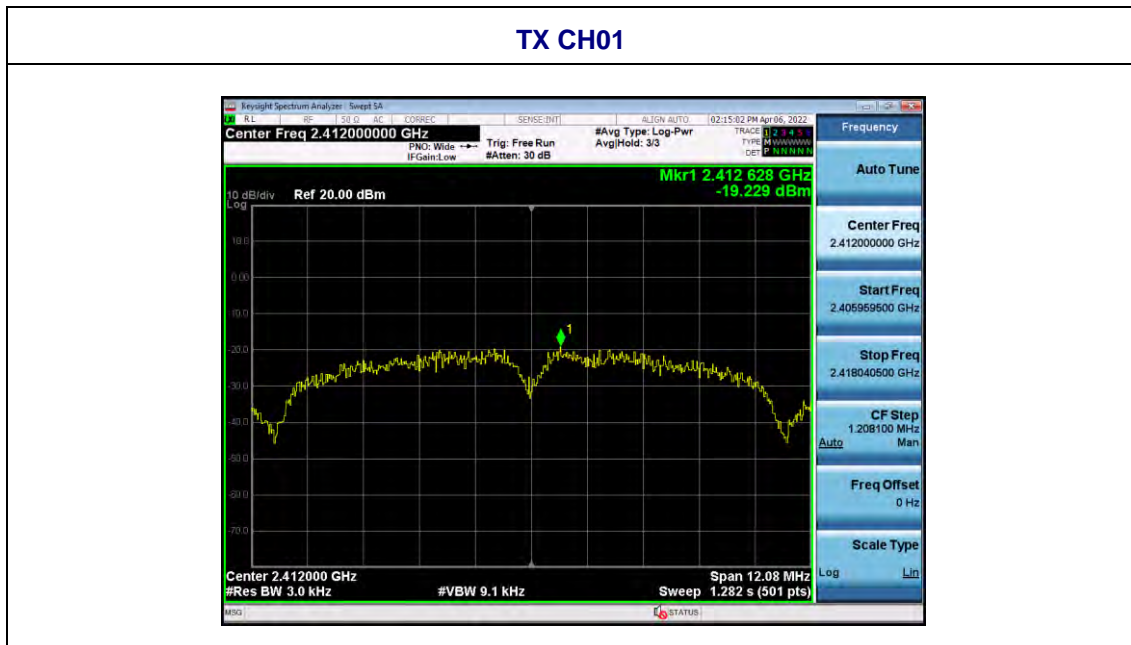

TX CH06



TX CH11



Temperature :	26°C	Relative Humidity :	54%
Pressure :	101kPa	Test Voltage :	DC 7.4V
Test Mode :	TX g Mode		

Frequency	Power Spectral Density (dBm/3kHz)	Limit (dBm/3kHz)	Result
2412 MHz	-24.932	8	PASS
2437 MHz	-25.138	8	PASS
2462 MHz	-26.038	8	PASS

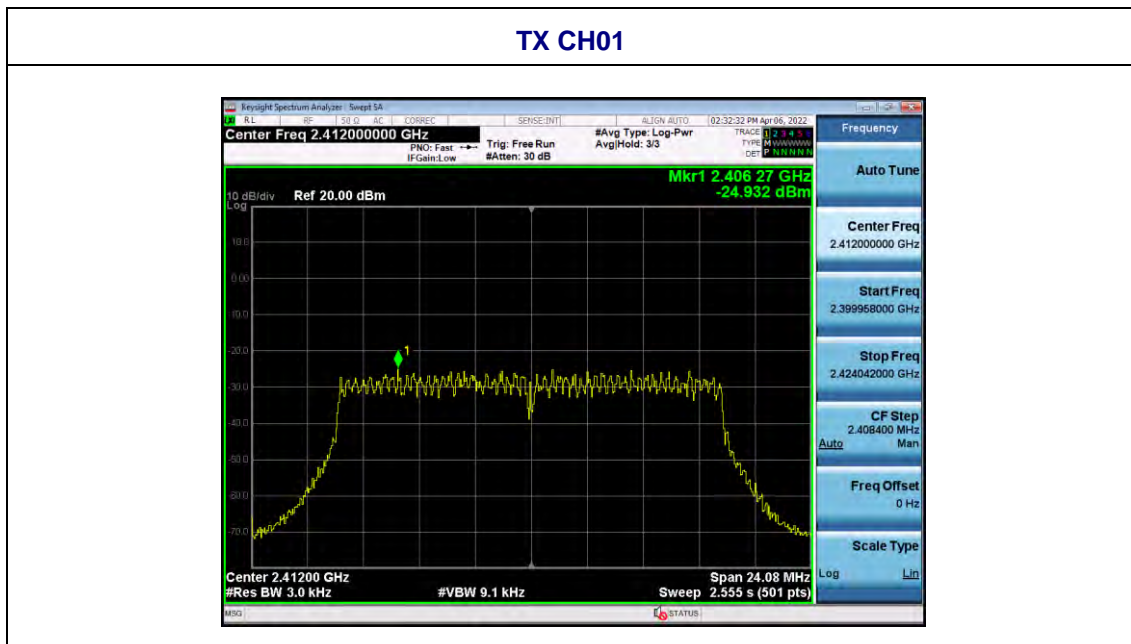

TX CH06

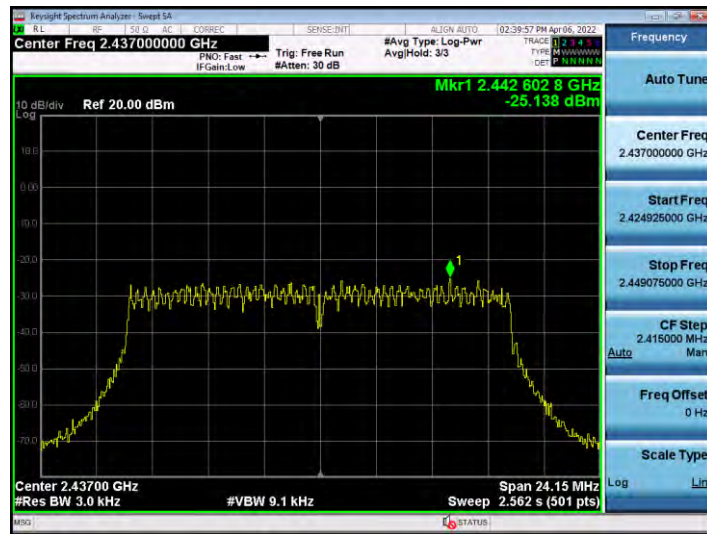

TX CH11

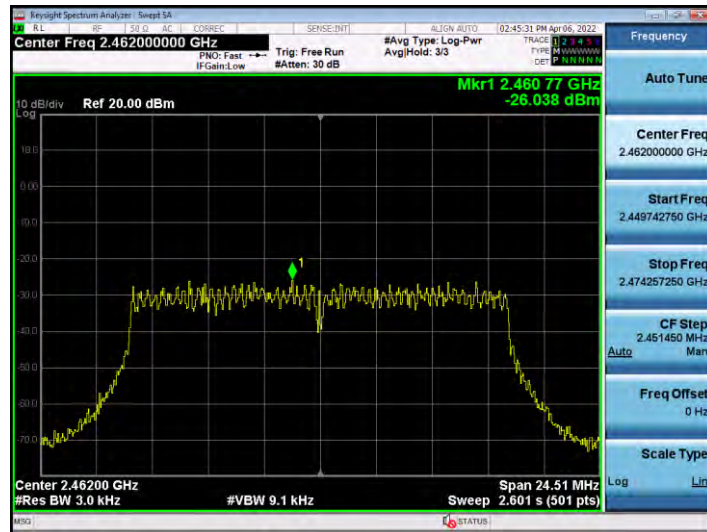

Temperature :	26°C	Relative Humidity :	54%
Pressure :	101kPa	Test Voltage :	DC 7.4V
Test Mode :	TX n Mode(20M)		

Frequency	Power Spectral Density (dBm/3kHz)	Limit (dBm/3kHz)	Result
2412 MHz	-25.742	8	PASS
2437 MHz	-25.604	8	PASS
2462 MHz	-25.923	8	PASS

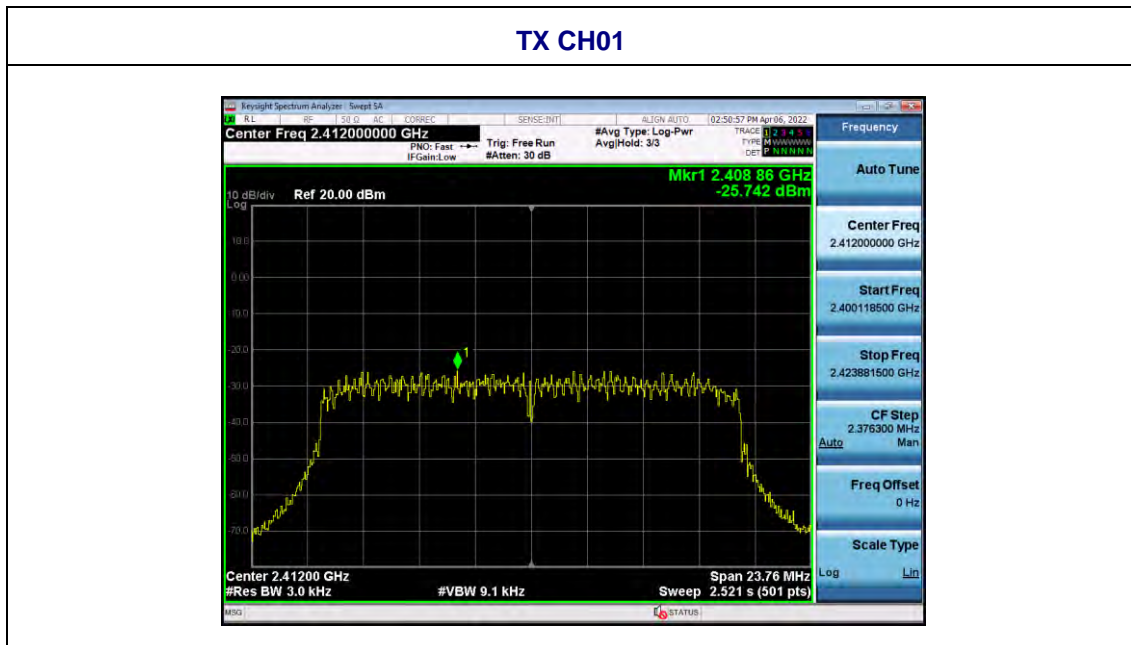

TX CH06

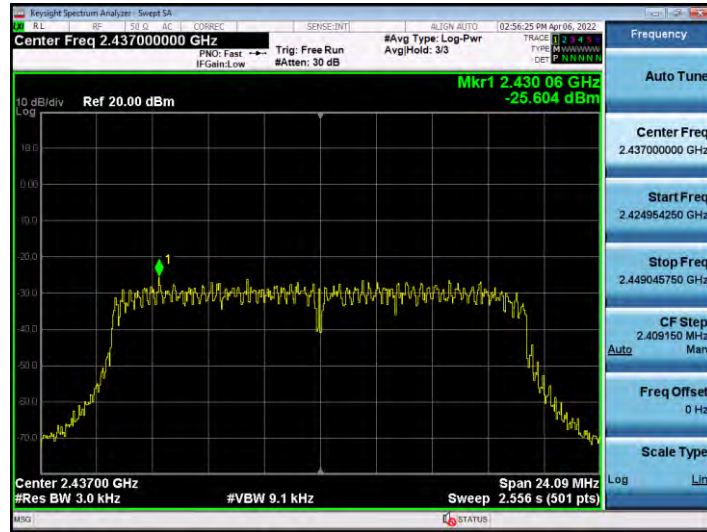

TX CH11

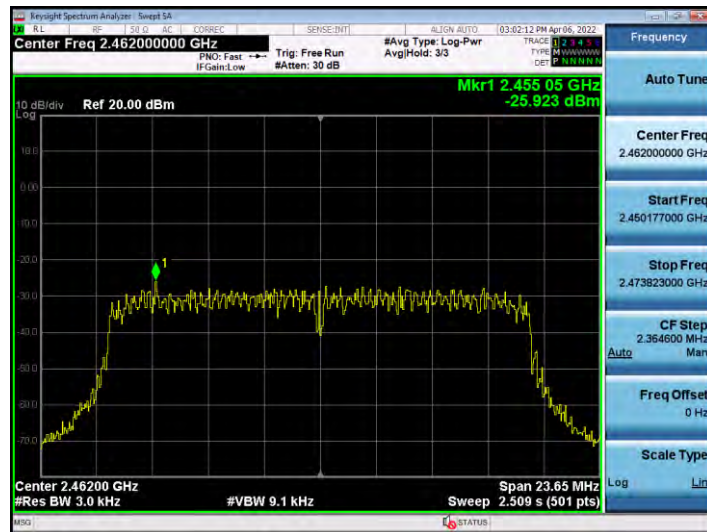

7. -6DB CHANNEL BANDWIDTH

Test Requirement:	FCC Part15 C Section 15.247 (a)(2)
Test Method:	KDB558074 D0115.247 Meas Guidancev05r02

7.1 APPLIED PROCEDURES / LIMIT

FCC Part15 (15.247) , Subpart C				
Section	Test Item	Limit	Frequency Range (MHz)	Result
15.247(a)(2)	Bandwidth	$\geq 500\text{KHz}$ (6dB bandwidth)	2400-2483.5	PASS

7.2 TEST PROCEDURE

1. Set RBW = 100 kHz.
2. Set the video bandwidth (VBW) $\geq 3 \times \text{RBW}$.
3. Detector = Peak.
4. Trace mode = max hold.
5. Sweep = auto couple.
6. Allow the trace to stabilize.
7. Measure the maximum width of the emission that is constrained by the frequencies associated with the two outermost amplitude points (upper and lower frequencies) that are attenuated by 6 dB relative to the maximum level measured in the fundamental emission.

7.3 DEVIATION FROM STANDARD

No deviation.

7.4 TEST SETUP

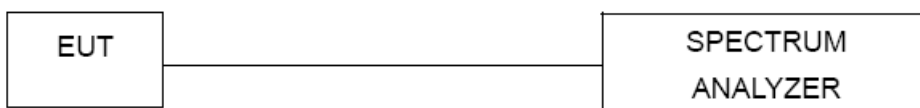

7.5 EUT OPERATION CONDITIONS

The EUT tested system was configured as the statements of 2.4 Unless otherwise a special operating condition is specified in the follows during the testing.

7.6 TEST RESULT

Temperature :	26°C	Relative Humidity :	54%
Pressure :	101kPa	Test Voltage :	DC 7.4V
Test Mode :	TX Mode		

Test CH	-6dB Channel Bandwidth (MHz)			Limit(KHz)	Result
	802.11b	802.11g	802.11n(HT20)		
Lowest	8.054	16.06	15.84	>500	Pass
Middle	8.553	16.10	16.06		
Highest	8.070	16.34	15.76		

Test plot as follows:

802.11b

802.11g

Lowest channel

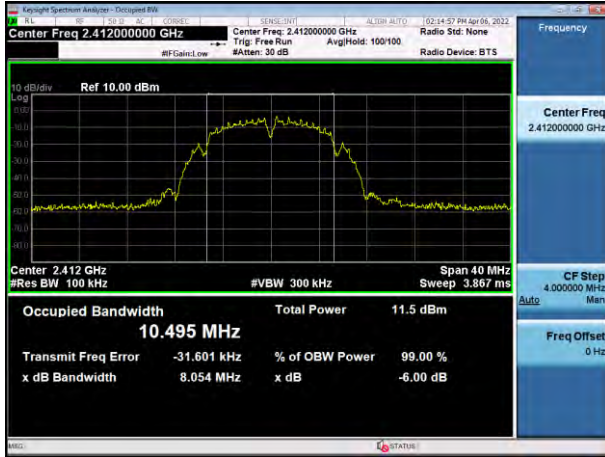

Middle channel

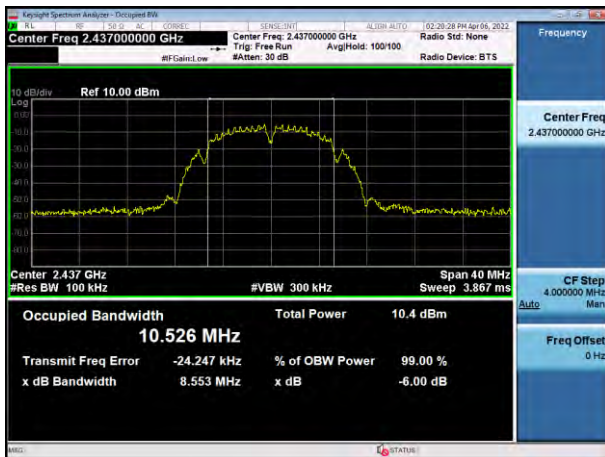

Highest channel

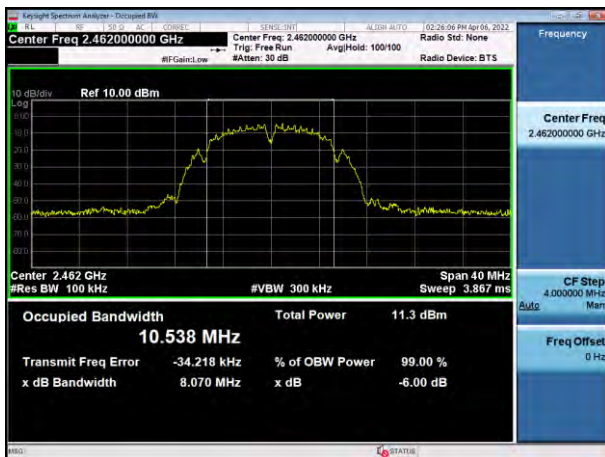

802.11n20

Lowest channel

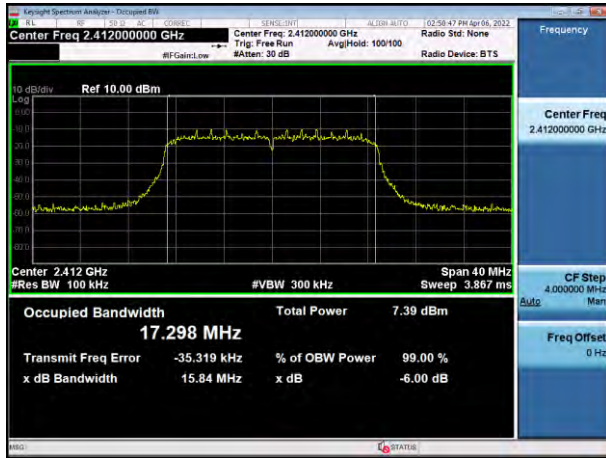

Middle channel

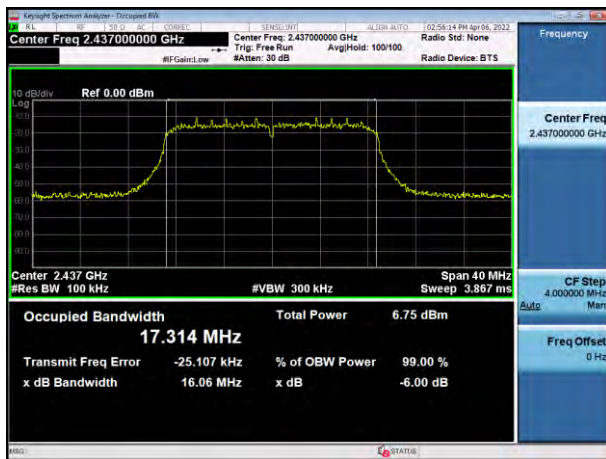

Highest channel

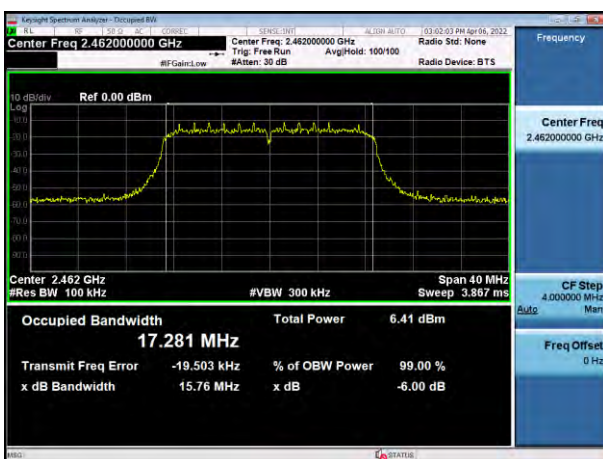

8.OUTPUT POWER TEST

Test Requirement:	FCC Part15 C Section 15.247 (b)(3)
Test Method:	KDB558074 D0115.247 Meas Guidancev05r02

8.1 APPLIED PROCEDURES/LIMIT

FCC Part15 (15.247) , Subpart C				
Section	Test Item	Limit	Frequency Range (MHz)	Result
15.247(b)(3)	Peak Output Power	1 watt or 30dBm	2400-2483.5	PASS

8.2 TEST PROCEDURE

- a. The EUT was directly connected to the Power meter

8.3 DEVIATION FROM STANDARD

No deviation.

8.4 TEST SETUP



8.5 EUT OPERATION CONDITIONS

The EUT tested system was configured as the statements of 2.4 Unless otherwise a special operating condition is specified in the follows during the testing.

8.6 TEST RESULT

Temperature :	26°C	Relative Humidity :	54%
Pressure :	101kPa	Test Voltage :	DC 7.4V

Test CH	Peak Output Power (dBm)			Limit(dBm)	Result
	802.11b	802.11g	802.11n(HT20)		
Lowest	7.668	8.237	8.140	30.00	Pass
Middle	6.861	7.648	7.312		
Highest	7.388	7.332	7.254		

9. CONDUCTED BAND EDGE AND SPURIOUS EMISSION

Test Requirement:	FCC Part15 C Section 15.247 (d)
Test Method:	KDB558074 D0115.247 Meas Guidancev05r02

9.1 APPLICABLE STANDARD

in any 100 kHz bandwidth outside the frequency bands in which the spread spectrum intentional radiator is operating, the radio frequency power that is produced by the intentional radiator shall be at least 20dB below that in the 100kHz bandwidth within the band that contains the highest level of the desired power, In addition, radiated emissions which fall in the restricted bands, as defined in§15.205(a), must also comply with the radiated emission limits specified in15.209(a).

9.2 TEST PROCEDURE

Using the following spectrum analyzer setting:

- A) Set the RBW = 100KHz.
- B) Set the VBW = 300KHz.
- C) Sweep time = auto couple.
- D) Detector function = peak.
- E) Trace mode = max hold.
- F) Allow trace to fully stabilize.

9.3 DEVIATION FROM STANDARD

No deviation.

9.4 TEST SETUP



9.5 EUT OPERATION CONDITIONS

The EUT tested system was configured as the statements of 2.4 Unless otherwise a special operating condition is specified in the follows during the testing.

9.6 TEST RESULTS

Test plot as follows:

Test mode: 802.11b

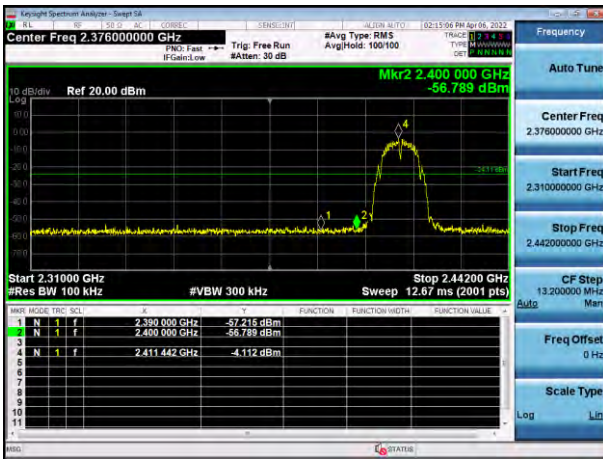

Lowest channel

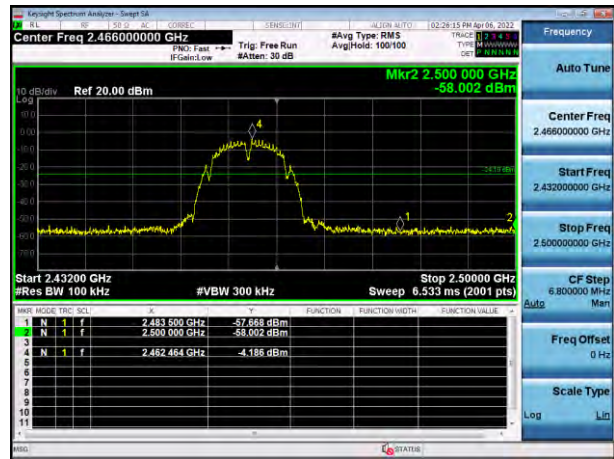

Highest channel

Test mode: 802.11g

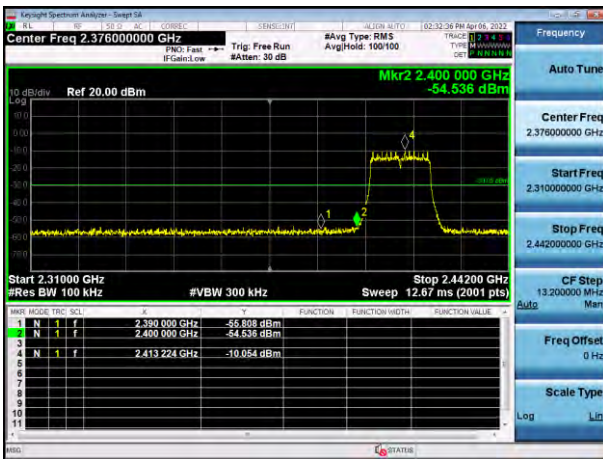

Lowest channel

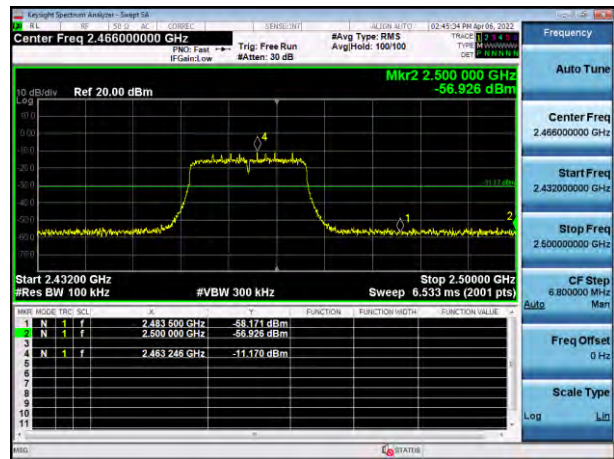

Highest channel

Test mode:

802.11n(HT20)

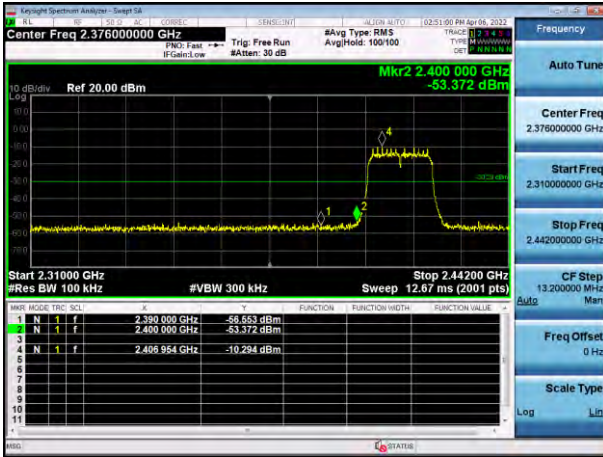

Lowest channel

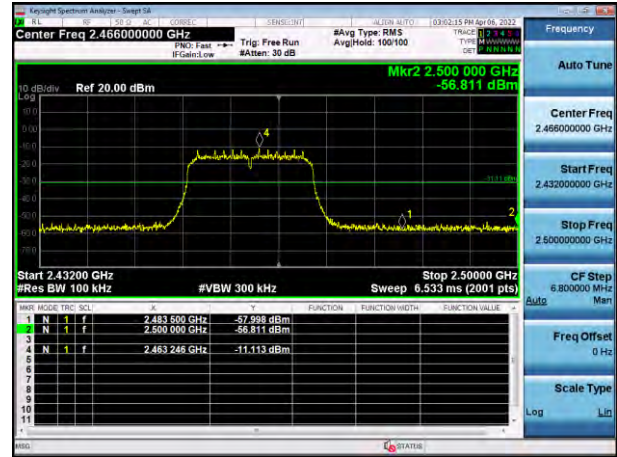

Highest channel

Test plot as follows:

802.11bLowest channel

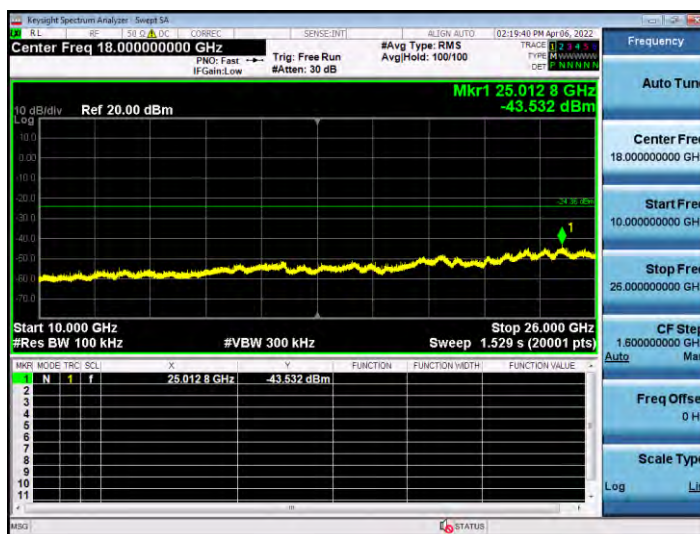
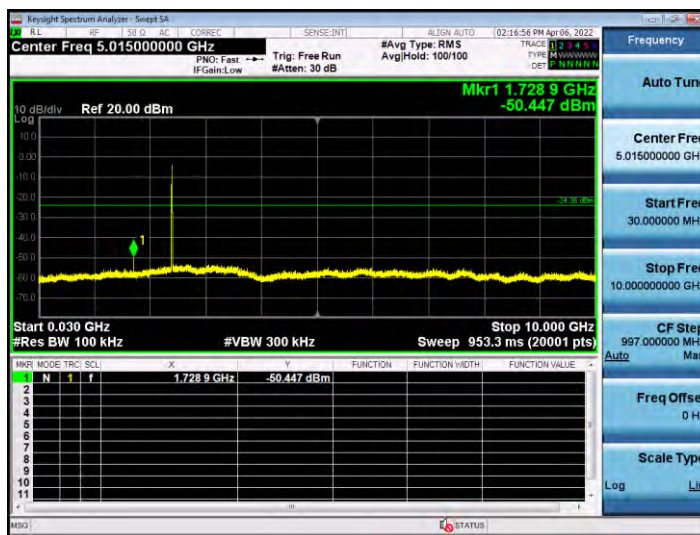
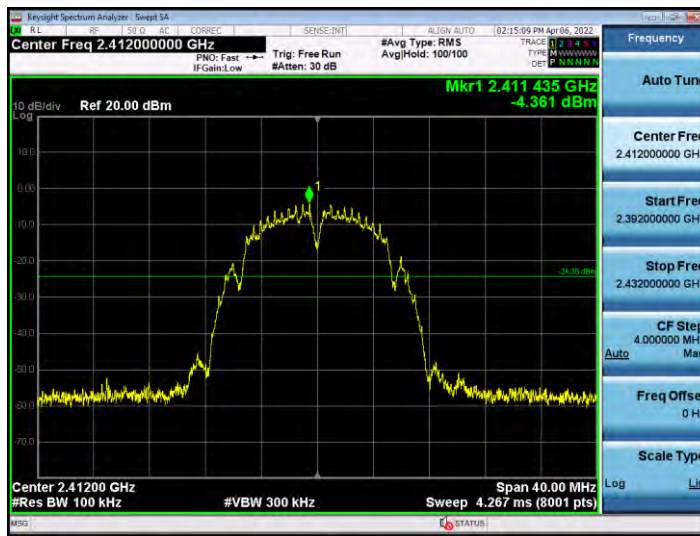

802.11b Middle channel

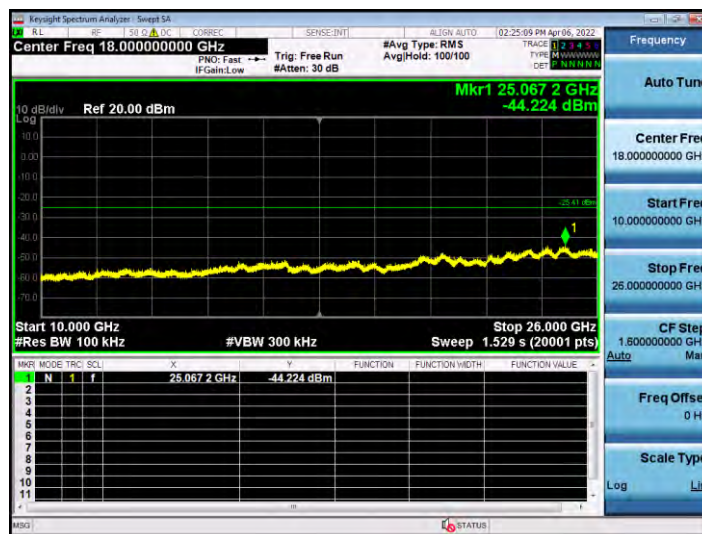
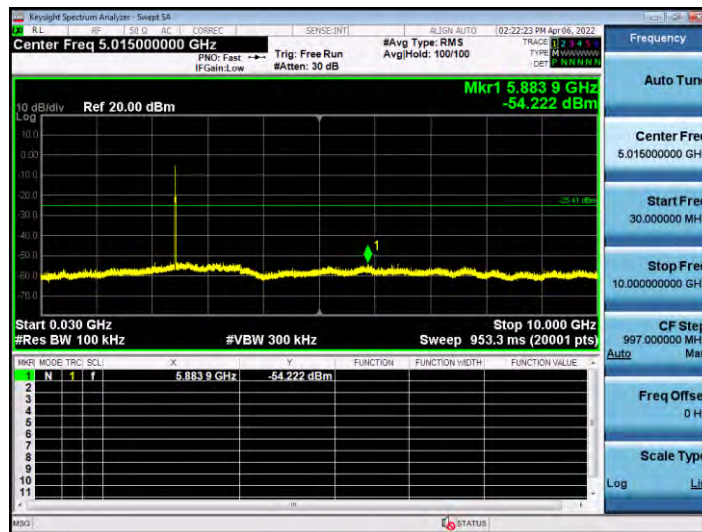
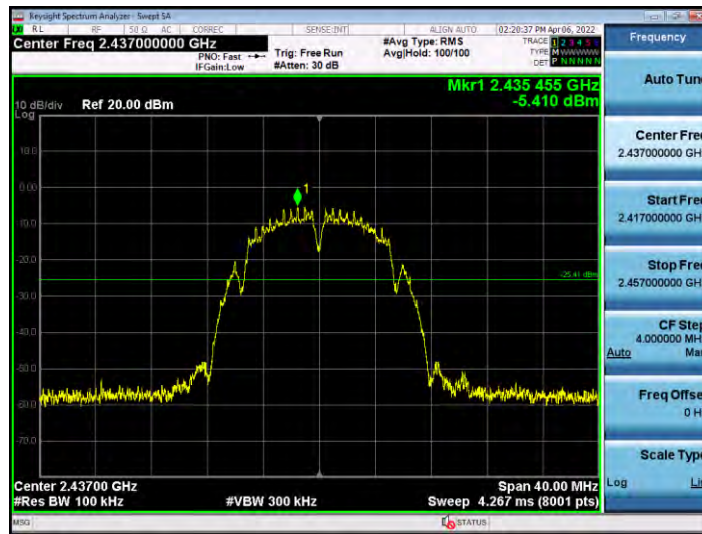

802.11b Highest channel

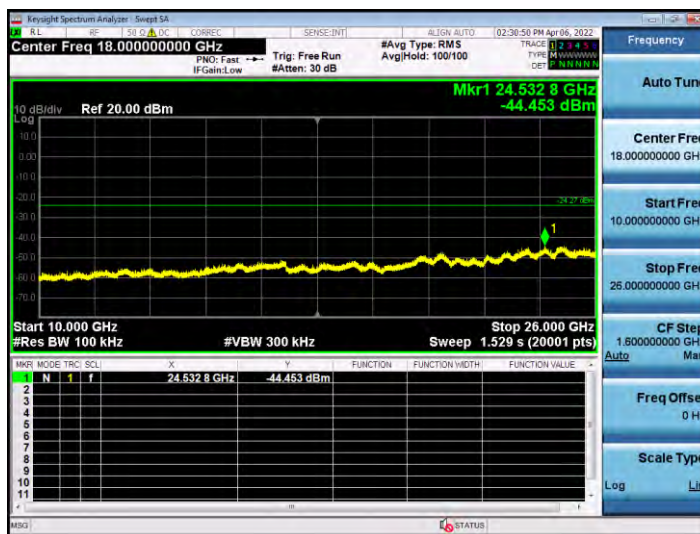
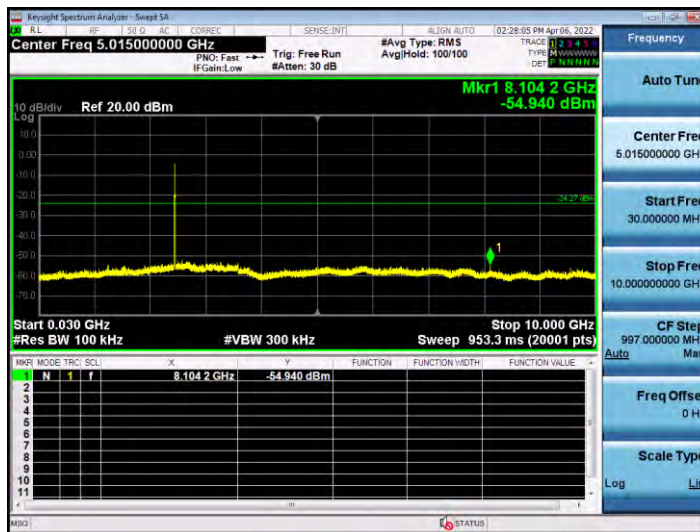
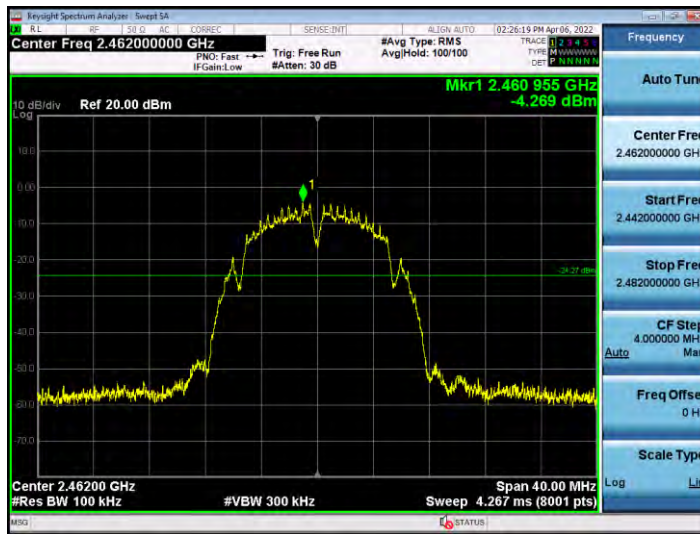

802.11gLowest channel

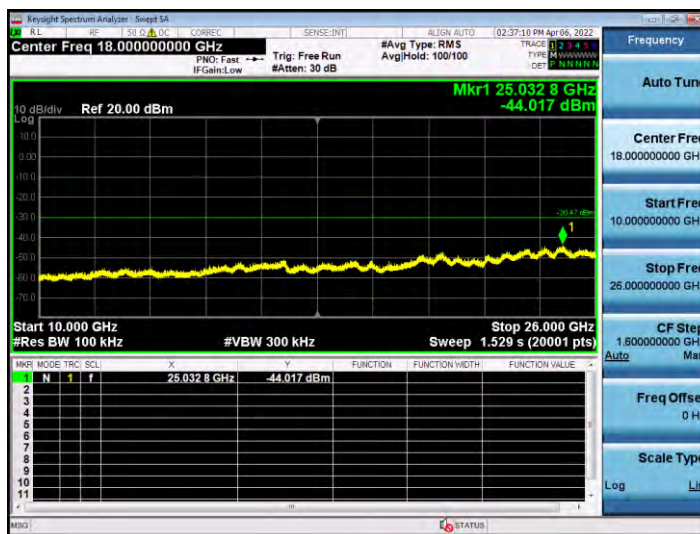
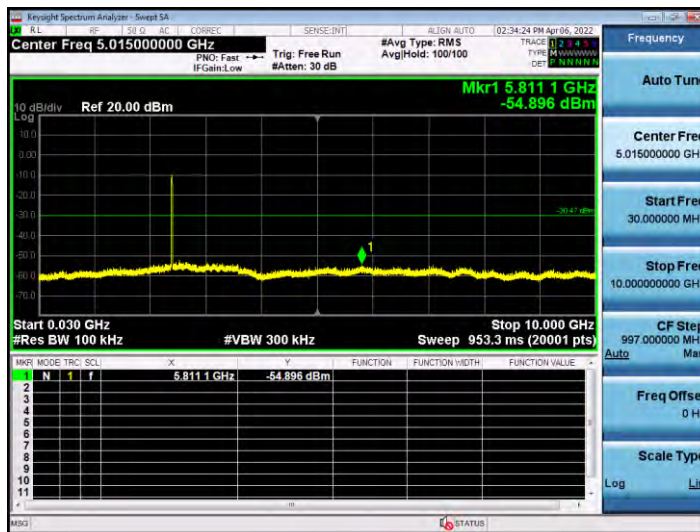
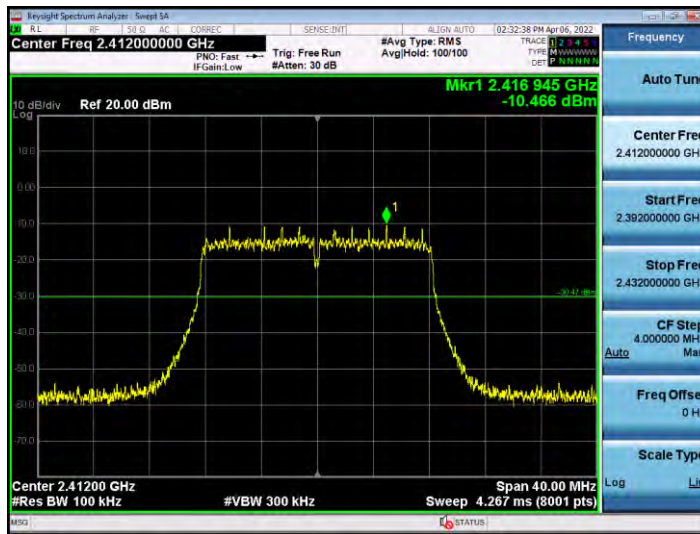

802.11g Middle channel

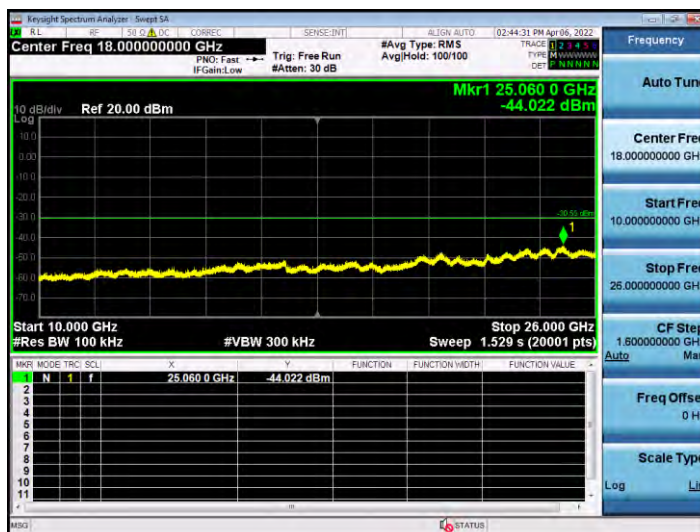
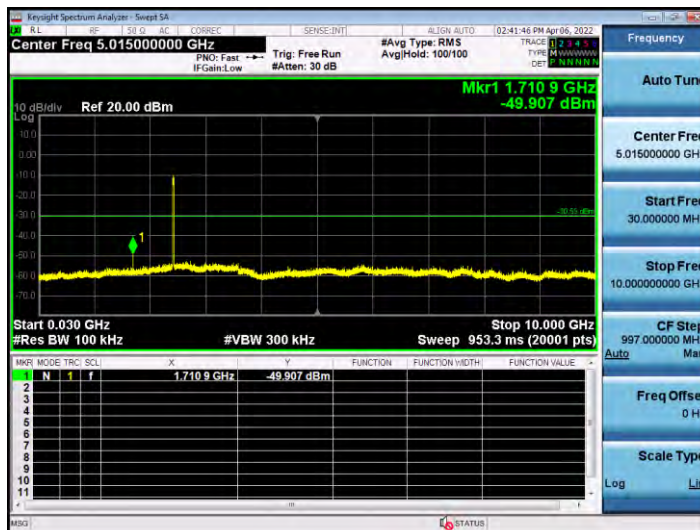
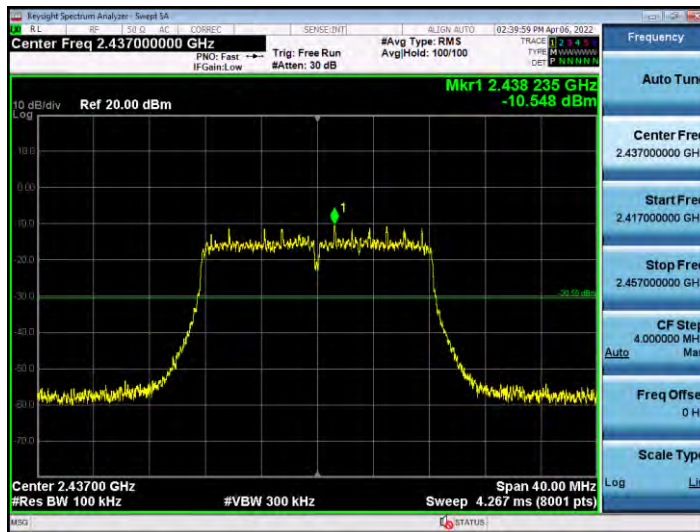

802.11g Highest channel

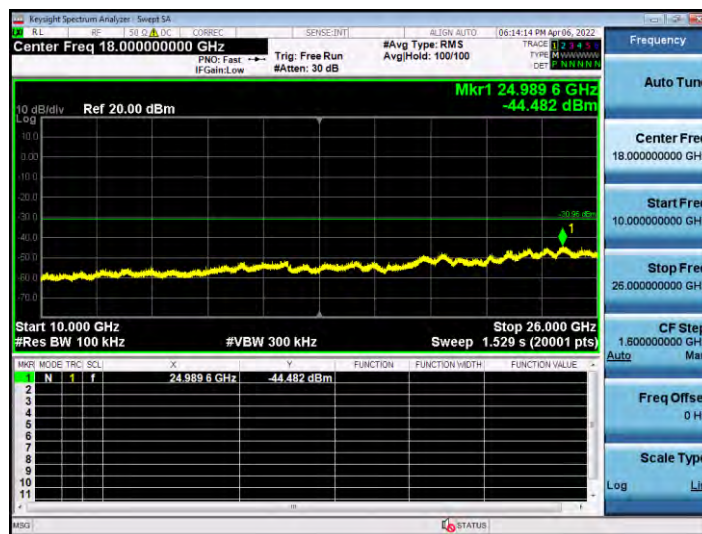
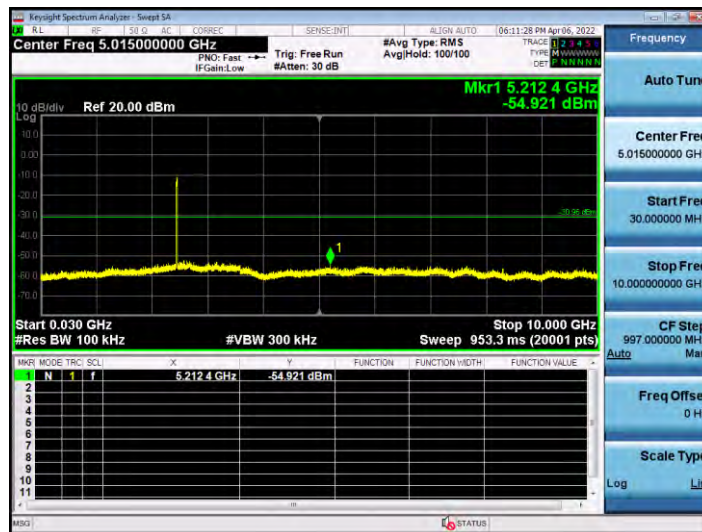
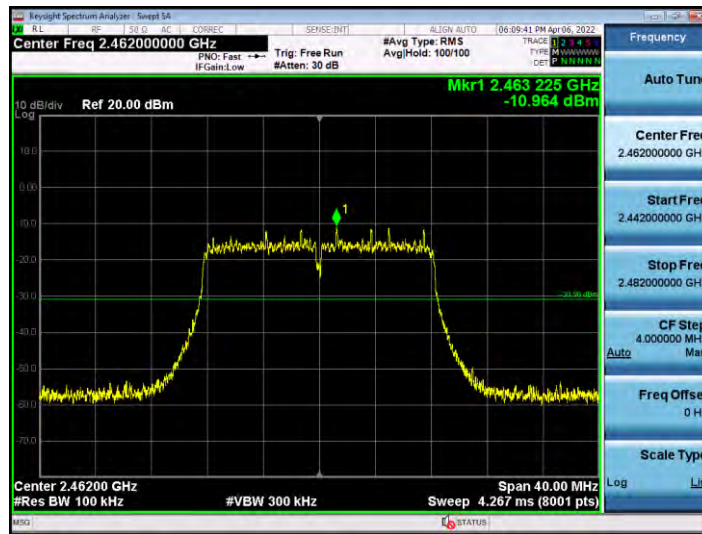

802.11n(HT20)Lowest channel

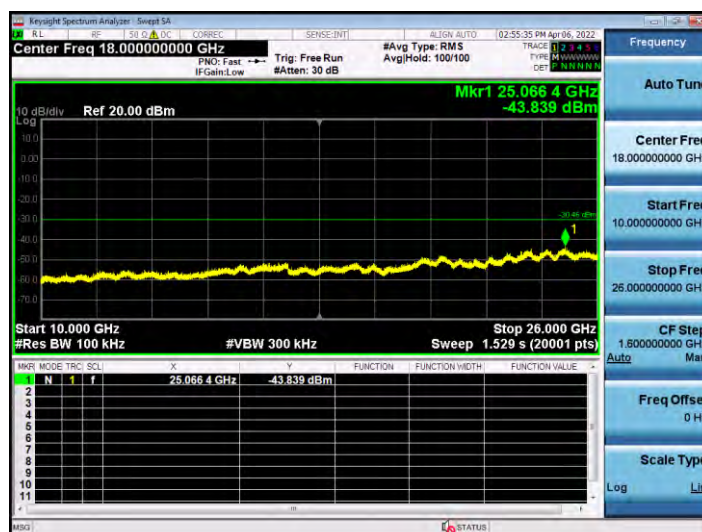
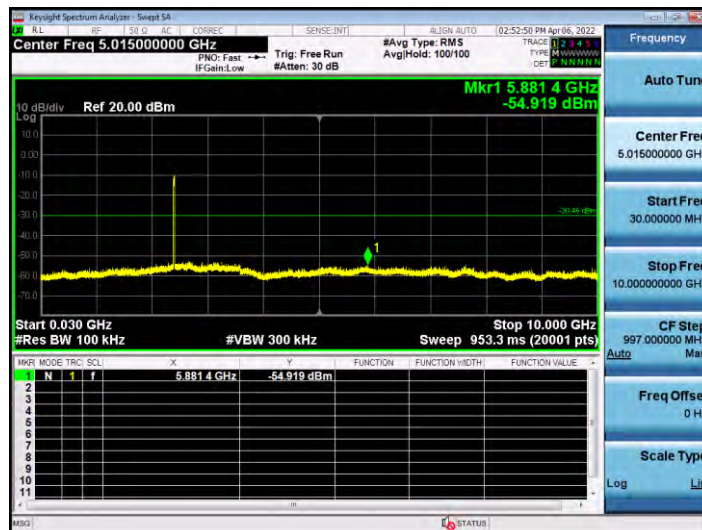
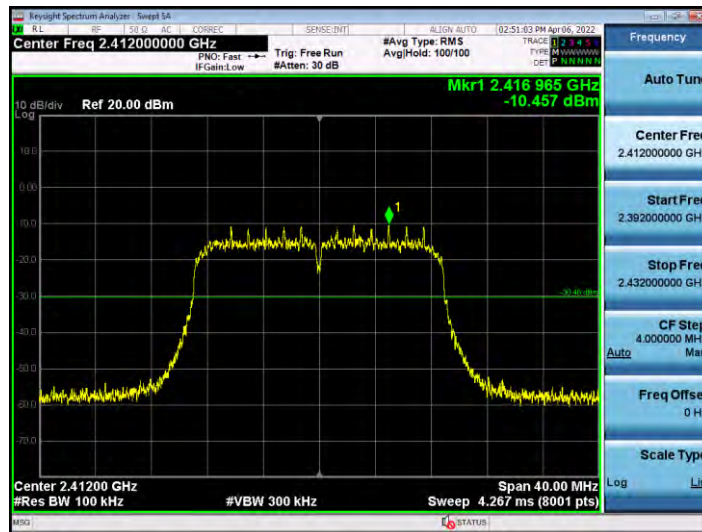

802.11n(HT20)Middle channel

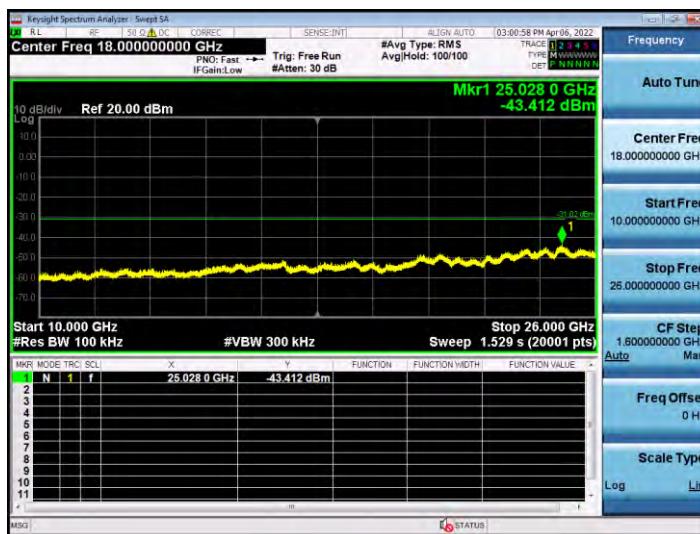
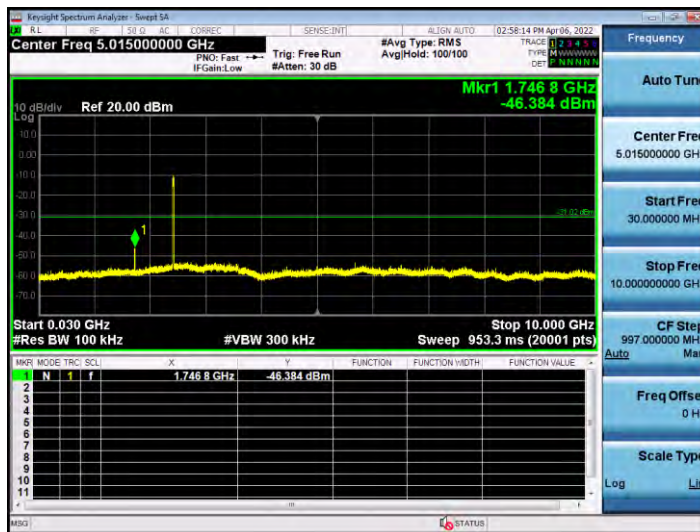
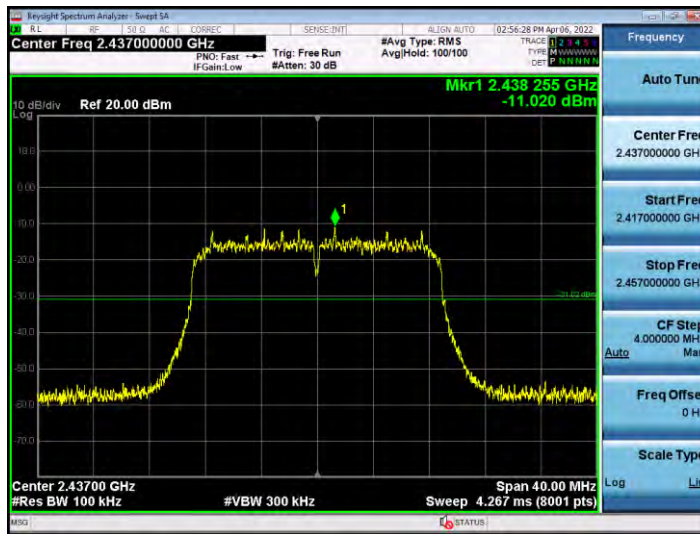

802.11n(HT20)Highest channel

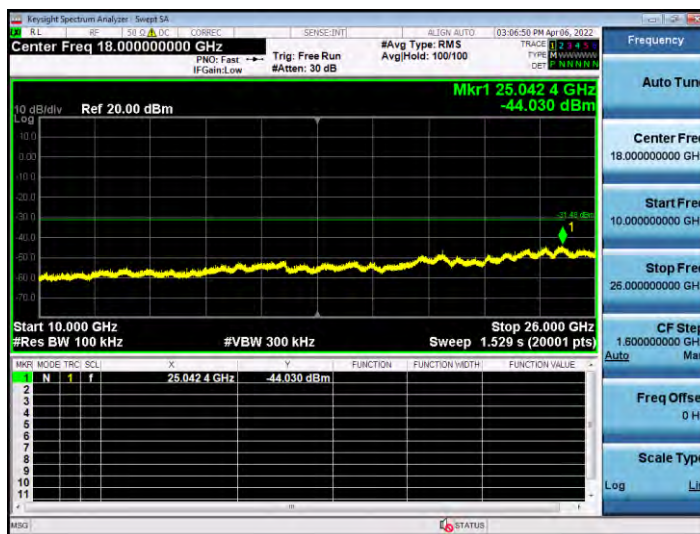
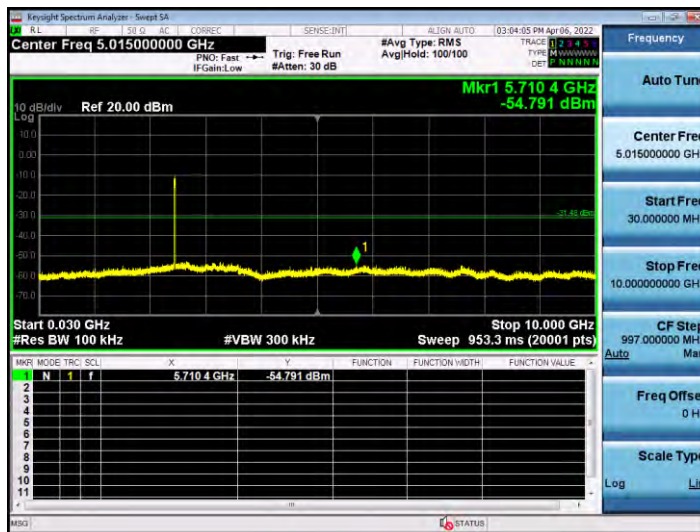
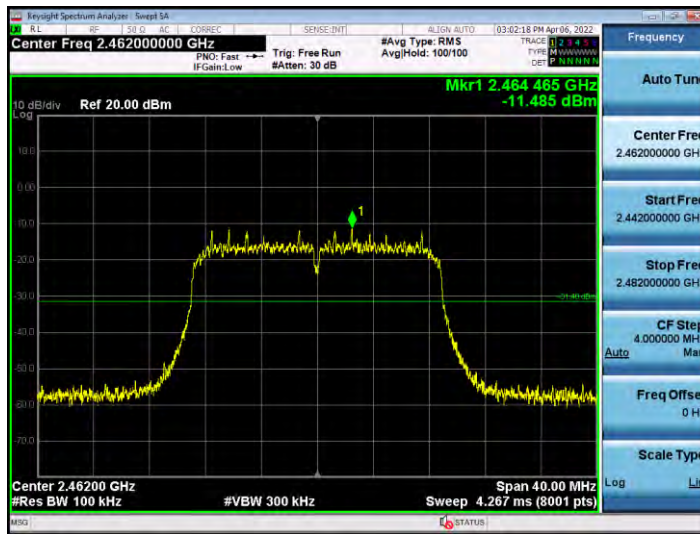

10. ANTENNA REQUIREMENT

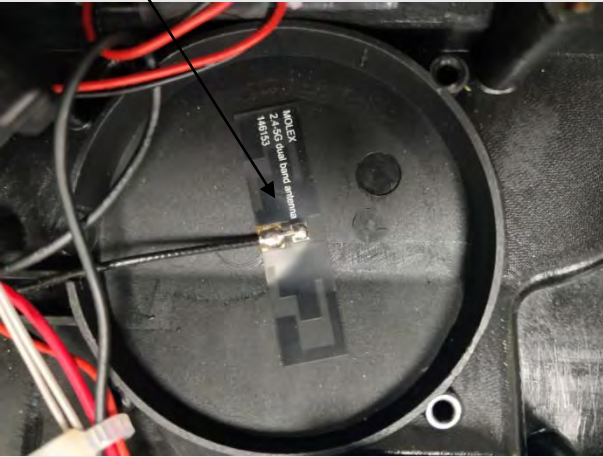
Standard requirement:	FCC Part15 C Section 15.203 /247(c)
<p>For intentional device, according to FCC 47 CFR Section 15.203, an intentional radiator shall be designed to ensure that no antenna other than that furnished by the responsible party shall be used with the device. And according to FCC 47 CFR Section 15.247, if transmitting antennas of directional gain greater than 6dBi are used, the power shall be reduced by the amount in dB that the directional gain of the antenna exceeds 6dBi.</p> <p>Refer to statement below for compliance.</p> <p>The manufacturer may design the unit so that the user can replace a broken antenna, but the use of a standard antenna jack or electrical connector is prohibited. Further, this requirement does not apply to intentional radiators that must be professionally installed.</p> <p>Antenna Connected Construction</p> <p>The FPC antenna used in the product is a permanently connected antenna that complies with the provisions of part 15.203 requirement in this section. The antenna used in this product is a FPC antenna, The directional gains of antenna used for transmitting is 1.33 dBi.</p>	
<p>FPC Antenna:</p> 	

11. TEST SETUP PHOTO

Please refer to the report NO.: ZKT-220406L2203-01

12. EUT CONSTRUCTIONAL DETAILS

Please refer to external photos file and internal photos file

※※※※※ END OF REPORT ※※※※※