



Shenzhen CTL Testing Technology Co., Ltd.
Tel: +86-755-89486194 E-mail: ctl@ctl-lab.com

TEST REPORT

FCC PART 15.247

Report Reference No. : CTL2207272062-WF

Compiled by: Happy Guo
(position+printed name+signature) (File administrators)

Tested by: Gray Gao
(position+printed name+signature) (Test Engineer)

Approved by: Ivan Xie
(position+printed name+signature) (Manager)



Product Name : Wireless RV Leveling System

Model/Type reference : GN-100

List Model(s)..... : N/A

Trade Mark..... : N/A

FCC ID..... : 2A8G2-GN100

Applicant's name : Huzhou Ancestor Electronic Technology Co., Ltd

Address of applicant : 4FL 15# Antong Zhihuigu,Wuxing District Huzhou City, Zhejiang Province, China

Test Firm..... : Shenzhen CTL Testing Technology Co., Ltd.

Address of Test Firm : Floor 1-A, Baisha Technology Park, No.3011, Shahexi Road, Nanshan District, Shenzhen, China 518055

Test specification..... :

Standard : FCC Part 15.247: Operation within the bands 902-928 MHz, 2400-2483.5 MHz and 5725-5850 MHz.

TRF Originator : Shenzhen CTL Testing Technology Co., Ltd.

Master TRF..... : Dated 2011-01

Date of receipt of test item : Aug. 05, 2022

Date of Test Date..... : Aug. 05, 2022-Aug. 29, 2022

Date of Issue : Aug. 30, 2022

Result..... : Pass

Shenzhen CTL Testing Technology Co., Ltd. All rights reserved.

This publication may be reproduced in whole or in part for non-commercial purposes as long as the Shenzhen CTL Testing Technology Co., Ltd. is acknowledged as copyright owner and source of the material. Shenzhen CTL Testing Technology Co., Ltd. takes no responsibility for and will not assume liability for damages resulting from the reader's interpretation of the reproduced material due to its placement and context.

TEST REPORT

Test Report No. :	CTL2207272062-WF	Aug. 30, 2022 ----- Date of issue
--------------------------	-------------------------	---

Equipment under Test : Wireless RV Leveling System

Sample No : CTL220727206-1-S001

Model /Type : GN-100

Listed Models : N/A

Applicant : **Huzhou Ancestor Electronic Technology Co., Ltd**

Address : 4FL 15# Antong Zhihuigu,Wuxing District Huzhou City,
Zhejiang Province, China

Manufacturer : **Huzhou Ancestor Electronic Technology Co., Ltd**

Address : 4FL 15# Antong Zhihuigu,Wuxing District Huzhou City,
Zhejiang Province, China

Test result	Pass *
--------------------	---------------

* In the configuration tested, the EUT complied with the standards specified page 5.

The test results presented in this report relate only to the object tested.

This report shall not be reproduced, except in full, without the written approval of the issuing testing laboratory.

Table of Contents

Page

1. SUMMARY	5
1.1. TEST STANDARDS	5
1.2. TEST DESCRIPTION	5
1.3. TEST FACILITY	6
1.4. STATEMENT OF THE MEASUREMENT UNCERTAINTY	7
2. GENERAL INFORMATION	8
2.1. ENVIRONMENTAL CONDITIONS	8
2.2. GENERAL DESCRIPTION OF EUT	8
2.3. DESCRIPTION OF TEST MODES AND TEST FREQUENCY	9
2.4. EQUIPMENTS USED DURING THE TEST	10
2.5. RELATED SUBMITTAL(S) / GRANT (S)	10
2.6. MODIFICATIONS	10
3. TEST CONDITIONS AND RESULTS	11
3.1. RADIATED EMISSIONS AND BAND EDGE	11
3.2. MAXIMUM CONDUCTED OUTPUT POWER	21
3.3. POWER SPECTRAL DENSITY	22
3.4. 6DB BANDWIDTH	23
3.5. OUT-OF-BAND EMISSIONS	24
3.6. ANTENNA REQUIREMENT	25
4. TEST SETUP PHOTOS OF THE EUT	26
5. PHOTOS OF THE EUT	27

1. SUMMARY

1.1. TEST STANDARDS

The tests were performed according to following standards:

[FCC Rules Part 15.247](#): Frequency Hopping, Direct Spread Spectrum and Hybrid Systems that are in operation within the bands of 902-928 MHz, 2400-2483.5 MHz, and 5725-5850 MHz

[ANSI C63.10: 2013](#): American National Standard for Testing Unlicensed Wireless Devices

[KDB 558074 D01 v05r02](#): KDB558074 D01 15.247 Meas Guidance v05r02

1.2. Test Description

FCC PART 15.247		
FCC Part 15.207	AC Power Conducted Emission	N/A
FCC Part 15.247(a)(2)	6dB Bandwidth	PASS
FCC Part 15.247(d)	Spurious RF Conducted Emission	PASS
FCC Part 15.247(b)	Maximum Conducted Output Power	PASS
FCC Part 15.247(e)	Power Spectral Density	PASS
FCC Part 15.109/ 15.205/ 15.209	Radiated Emissions	PASS
FCC Part 15.247(d)	Band Edge	PASS
FCC Part 15.203/15.247 (b)	Antenna Requirement	PASS

1.3. Test Facility

1.3.1 Address of the test laboratory

Shenzhen CTL Testing Technology Co.,Ltd.

Floor 1-A, Baisha Technology Park, No. 3011, Shahexi Road, Nanshan, Shenzhen 518055 China

There is one 3m semi-anechoic chamber and two line conducted labs for final test. The Test Sites meet the requirements in documents ANSI C63.10 and CISPR 32/EN 55032 requirements.

1.3.2 Laboratory accreditation

The test facility is recognized, certified, or accredited by the following organizations:

CNAS-Lab Code: L7497

Shenzhen CTL Testing Technology Co., Ltd. has been assessed and proved to be in compliance with CNAS-CL01 Accreditation Criteria for Testing and Calibration Laboratories (identical to ISO/IEC 17025: 2005 General Requirements) for the Competence of Testing and Calibration Laboratories.

A2LA-Lab Cert. No. 4343.01

Shenzhen CTL Testing Technology Co., Ltd, EMC Laboratory has been accredited by A2LA for technical competence in the field of electrical testing, and proved to be in compliance with ISO/IEC 17025: 2005 General Requirements for the Competence of Testing and Calibration Laboratories and any additional program requirements in the identified field of testing.

IC Registration No.: 9618B

CAB identifier: CN0041

The 3m alternate test site of Shenzhen CTL Testing Technology Co., Ltd. EMC Laboratory has been registered by Innovation, Science and Economic Development Canada to test to Canadian radio equipment requirements with Registration No.: 9618B on Jan. 22, 2019.

FCC-Registration No.: 399832

Designation No.: CN1216

Shenzhen CTL Testing Technology Co., Ltd. EMC Laboratory has been registered and fully described in a report filed with the (FCC) Federal Communications Commission. The acceptance letter from the FCC is maintained in our files. Registration 399832, December 08, 2017.

1.4. Statement of the measurement uncertainty

The data and results referenced in this document are true and accurate. The reader is cautioned that there may be errors within the calibration limits of the equipment and facilities. The measurement uncertainty was calculated for all measurements listed in this test report acc. to CISPR 16 - 4 "Specification for radio disturbance and immunity measuring apparatus and methods – Part 4: Uncertainty in EMC Measurements" and is documented in the Shenzhen CTL Testing Technology Co., Ltd. quality system acc. to DIN EN ISO/IEC 17025. Furthermore, component and process variability of devices similar to that tested may result in additional deviation. The manufacturer has the sole responsibility of continued compliance of the device.

Hereafter the best measurement capability for CTL laboratory is reported:

Test	Measurement Uncertainty	Notes
Transmitter power conducted	±0.57 dB	(1)
Transmitter power Radiated	±2.20 dB	(1)
Conducted spurious emission 9KHz-40 GHz	±1.60 dB	(1)
Occupied Bandwidth	±0.20ppm	(1)
Radiated Emission 9KHz~30MHz	±3.66dB	(1)
Radiated Emission 30~1000MHz	±4.10dB	(1)
Radiated Emission Above 1GHz	±4.32dB	(1)
Conducted Disturbance 0.15~30MHz	±3.20dB	(1)
Power Spectral Density	±0.57 dB	(1)

- (1) This uncertainty represents an expanded uncertainty expressed at approximately the 95% confidence level using a coverage factor of k=2.

2. GENERAL INFORMATION

2.1. Environmental conditions

During the measurement the environmental conditions were within the listed ranges:

Normal Temperature:	25°C
Relative Humidity:	55 %
Air Pressure:	101 kPa

2.2. General Description of EUT

Product Name:	Wireless RV Leveling System
Model/Type reference:	GN-100
Power supply:	DC 3.0V from Battery
Bluetooth LE	
Supported type:	Bluetooth Low Energy
Modulation:	GFSK
Operation frequency:	2402MHz to 2480MHz
Channel number:	40
Channel separation:	1MHz
Antenna type:	PCB Antenna
Antenna gain:	0.944dBi

Note1: For more details, please refer to the user's manual of the EUT.

Note2: Antenna gain provided by the applicant.

2.3. Description of Test Modes and Test Frequency

The Applicant provides communication tools software to control the EUT for staying in continuous transmitting and receiving mode for testing.

There are 40 channels provided to the EUT and Channel 00/19/39 were selected for BLE test.

Operation Frequency List :

Channel	Frequency (MHz)
00	2402
02	2404
03	2406
⋮	⋮
19	2440
⋮	⋮
37	2476
38	2478
39	2480

Note: The line display in grey were the channel selected for testing

2.4. Equipments Used during the Test

Test Equipment	Manufacturer	Model No.	Serial No.	Calibration Date	Calibration Due Date
LISN	R&S	ESH2-Z5	860014/010	2022/05/07	2023/05/06
Double cone logarithmic antenna	Schwarzbeck	VULB 9168	824	2020/04/07	2023/04/06
Horn Antenna	Ocean Microwave	OBH100400	26999002	2019/11/28	2022/11/27
EMI Test Receiver	R&S	ESCI	1166.5950.03	2022/05/07	2023/05/06
Spectrum Analyzer	Agilent	E4407B	MY41440676	2022/05/07	2023/05/06
Spectrum Analyzer	Agilent	N9020A	US46220290	2022/05/07	2023/05/06
Spectrum Analyzer	Keysight	N9020A	MY53420874	2022/05/07	2023/05/06
Horn Antenna	Sunol Sciences Corp.	DRH-118	A062013	2021/12/23	2024/12/22
Active Loop Antenna	Da Ze	ZN30900A	/	2021/05/13	2024/05/12
Amplifier	Agilent	8449B	3008A02306	2022/05/07	2023/05/06
Amplifier	Agilent	8447D	2944A10176	2022/05/06	2023/05/05
Amplifier	MRT	MRT-AP01M06	S-001	2022/05/07	2023/05/06
Amplifier	Brief&Smart	LNA-4018	2104197	2022/05/07	2023/05/06
Temperature/Humidity Meter	Ji Yu	MC501	/	2022/05/07	2023/05/06
Power Sensor	Agilent	U2021XA	MY55130004	2022/05/07	2023/05/06
Power Sensor	Agilent	U2021XA	MY55130006	2022/05/07	2023/05/06
Power Sensor	Agilent	U2021XA	MY54510008	2022/05/07	2023/05/06
Power Sensor	Agilent	U2021XA	MY55060003	2022/05/07	2023/05/06
Spectrum Analyzer	RS	FSP	1164.4391.38	2022/05/07	2023/05/06
Test Software					
Name of Software			Version		
TST-PASS			V1.1.0		
EZ_EMG(Below 1GHz)			V1.1.4.2		
EZ_EMG((Above 1GHz)			V1.1.4.2		

The calibration interval was one year

2.5. Related Submittal(s) / Grant (s)

This submittal(s) (test report) is intended to comply with Section 15.247 of the FCC Part 15, Subpart C Rules.

2.6. Modifications

No modifications were implemented to meet testing criteria.

3. TEST CONDITIONS AND RESULTS

3.1. Radiated Emissions and Band Edge

Limit

For intentional device, according to § 15.209(a), the general requirement of field strength of radiated emission out of authorized band shall not exceed the following table at a 3 meters measurement distance.

In addition, radiated emissions which fall in the restricted bands, as defined in §15.205(a), must also comply with the radiated emission limits specified in §15.209(a)

Radiated emission limits

Frequency (MHz)	Distance (Meters)	Radiated (dBµV/m)	Radiated (µV/m)
0.009-0.49	3	$20\log(2400/F(\text{KHz})) + 40\log(300/3)$	$2400/F(\text{KHz})$
0.49-1.705	3	$20\log(24000/F(\text{KHz})) + 40\log(30/3)$	$24000/F(\text{KHz})$
1.705-30	3	$20\log(30) + 40\log(30/3)$	30
30-88	3	40.0	100
88-216	3	43.5	150
216-960	3	46.0	200
Above 960	3	54.0	500

TEST CONFIGURATION

(A) Radiated Emission Test Set-Up, Frequency Below 30MHz

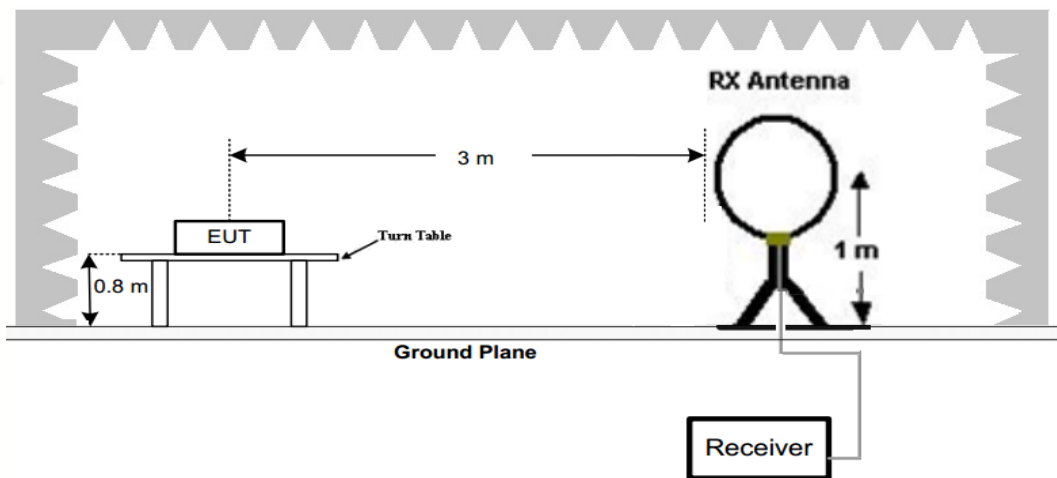

(B) Radiated Emission Test Set-Up, Frequency below 1000MHz

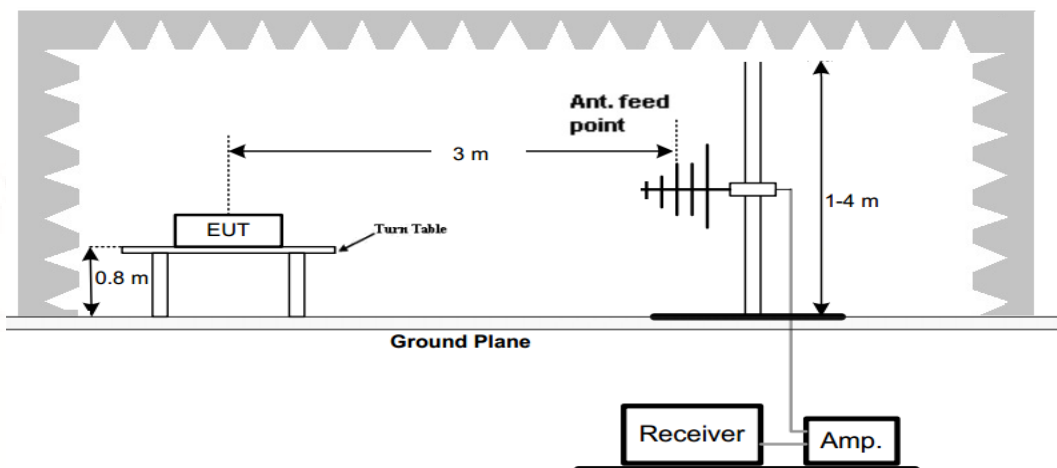

(C) Radiated Emission Test Set-Up, Frequency above 1000MHz

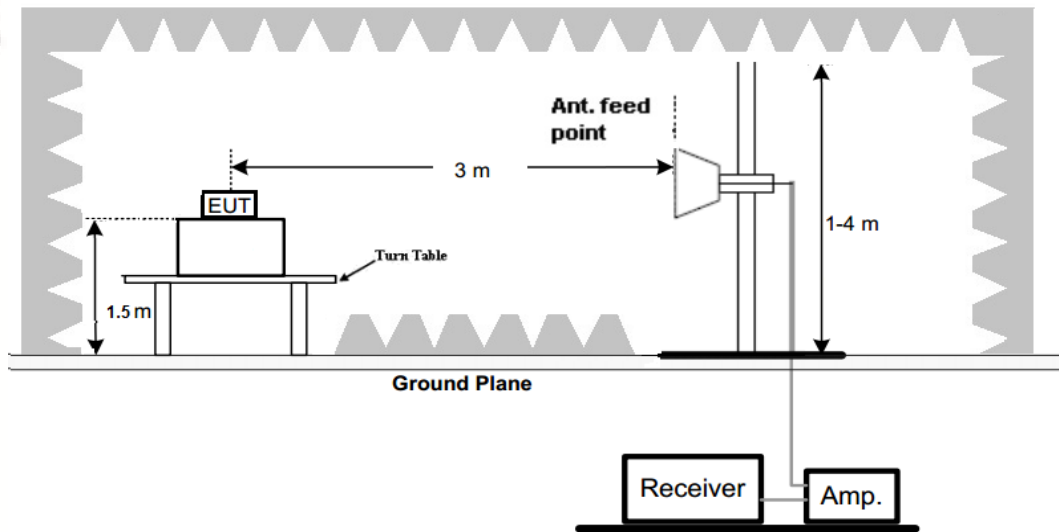

Test Procedure

1. Below 1GHz measurement the EUT is placed on a turntable which is 0.8m above ground plane, and above 1GHz measurement EUT was placed on a low permittivity and low loss tangent turn table which is 1.5m above ground plane.
2. Maximum procedure was performed by raising the receiving antenna from 1m to 4m and rotating the turn table from 0° to 360° to acquire the highest emissions from EUT
3. And also, each emission was to be maximized by changing the polarization of receiving antenna both horizontal and vertical.
4. Repeat above procedures until all frequency measurements have been completed.
5. The EUT was pretested with 3 orientations placed on the table for the radiated emission measurement –X, Y, and Z-plane. The X-plane results were found as the worst case and were shown in this report.

TEST RESULTS

Remark:

1. For below 1GHz testing recorded worst at BLE low channel.
2. Radiated emission test from 9 KHz to 10th harmonic of fundamental was verified, Found the emission level are attenuated 20dB below the limits from 9 kHz to 30MHz, so it does not recorded in report.

For 30MHz-1GHz

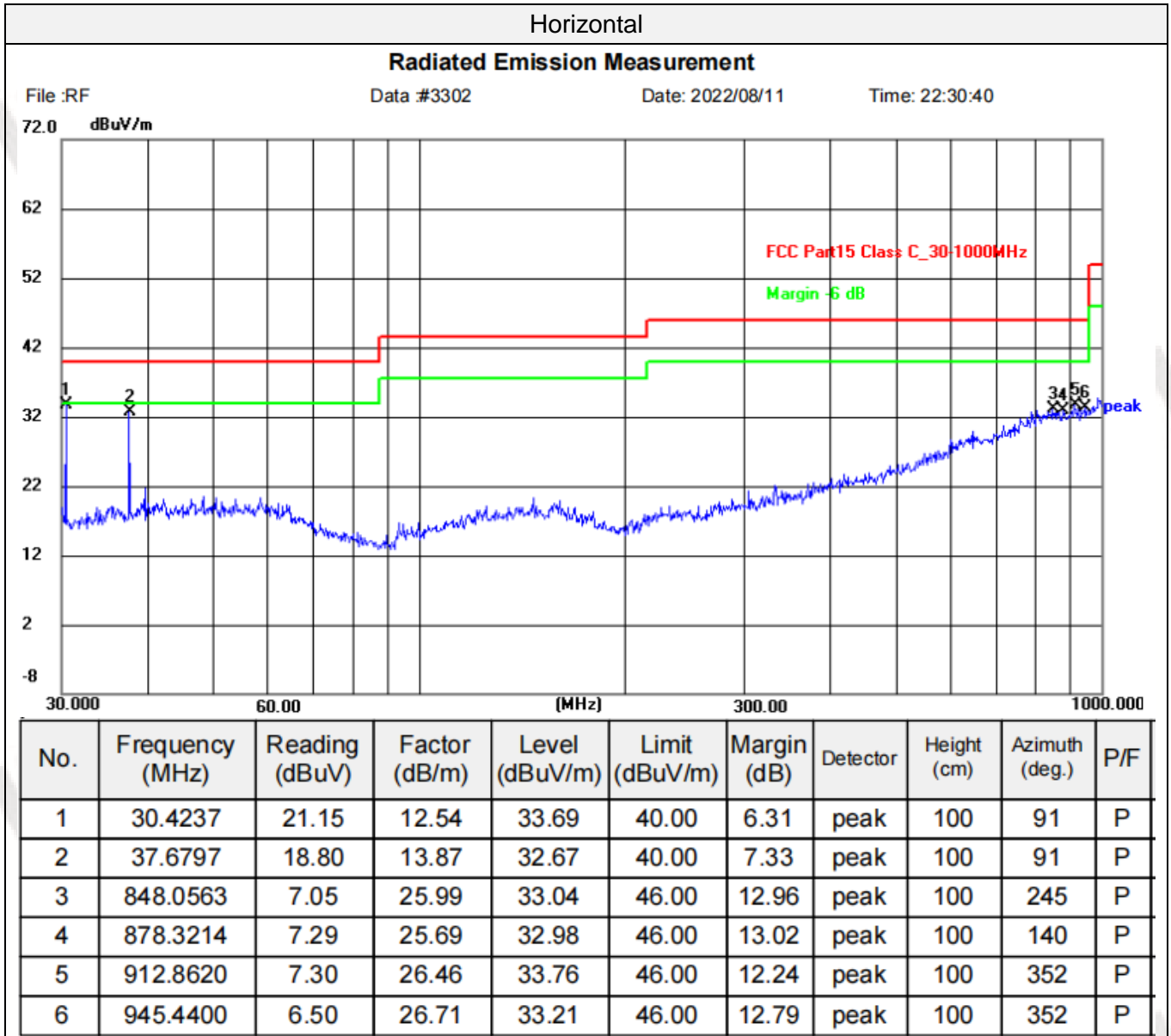

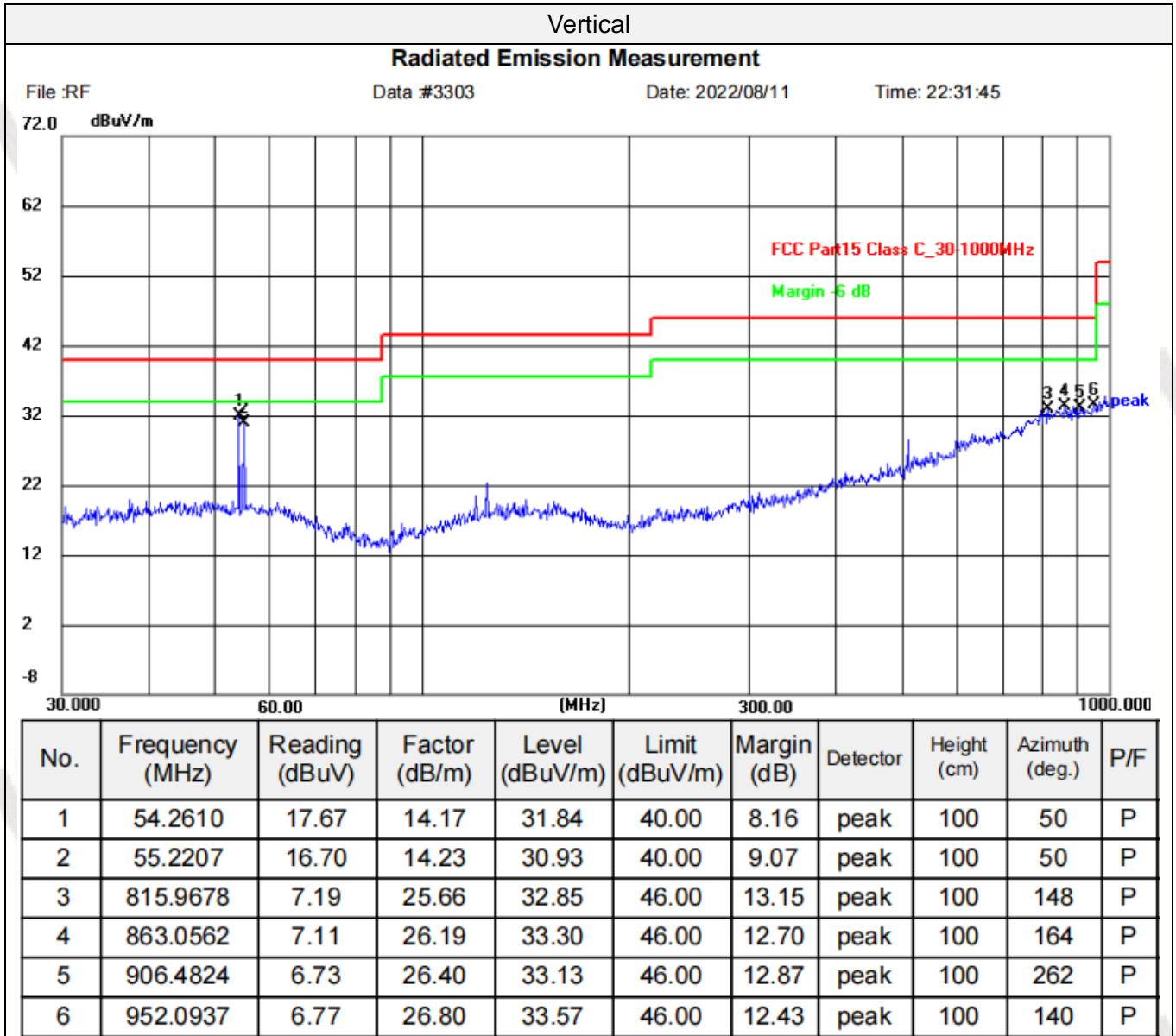

For 1GHz to 25GHz

BLE Mode (above 1GHz)

Frequency(MHz):			2402		Polarity:			HORIZONTAL	
Frequency (MHz)	Emission Level (dBuV/m)		Limit (dBuV/m)	Margin (dB)	Raw Value (dBuV)	Antenna Factor (dB/m)	Cable Factor (dB)	Pre-amplifier (dB)	Correction Factor (dB/m)
4804.00	48.61	PK	74.00	25.39	44.10	33.49	6.91	35.89	4.51
4804.00	--	AV	54.00	--	--	--	--	--	--
5382.00	44.72	PK	74.00	29.28	37.51	34.38	7.10	34.27	7.21
5382.00	--	AV	54.00	--	--	--	--	--	--
7206.00	47.48	PK	74.00	26.52	36.38	36.95	9.18	35.03	11.10
7206.00	--	AV	54.00	--	--	--	--	--	--

Frequency(MHz):			2402		Polarity:			VERTICAL	
Frequency (MHz)	Emission Level (dBuV/m)		Limit (dBuV/m)	Margin (dB)	Raw Value (dBuV)	Antenna Factor (dB/m)	Cable Factor (dB)	Pre-amplifier (dB)	Correction Factor (dB/m)
4804.00	48.55	PK	74.00	25.45	44.04	33.49	6.91	35.89	4.51
4804.00	--	AV	54.00	--	--	--	--	--	--
5479.00	44.27	PK	74.00	29.73	36.71	34.69	7.23	34.36	7.56
5479.00	--	AV	54.00	--	--	--	--	--	--
7206.00	45.91	PK	74.00	28.09	34.81	36.95	9.18	35.03	11.10
7206.00	--	AV	54.00	--	--	--	--	--	--

Frequency(MHz):			2440		Polarity:			HORIZONTAL	
Frequency (MHz)	Emission Level (dBuV/m)		Limit (dBuV/m)	Margin (dB)	Raw Value (dBuV)	Antenna Factor (dB/m)	Cable Factor (dB)	Pre-amplifier (dB)	Correction Factor (dB/m)
4880.00	47.15	PK	74.00	26.85	40.90	33.60	6.95	34.30	6.25
4880.00	--	AV	54.00	--	--	--	--	--	--
5649.00	43.47	PK	74.00	30.53	35.84	34.57	7.16	34.10	7.63
5649.00	--	AV	54.00	--	--	--	--	--	--
7320.00	45.68	PK	74.00	28.32	33.99	37.46	9.23	35.00	11.69
7320.00	--	AV	54.00	--	--	--	--	--	--

Frequency(MHz):			2440		Polarity:			VERTICAL	
Frequency (MHz)	Emission Level (dBuV/m)		Limit (dBuV/m)	Margin (dB)	Raw Value (dBuV)	Antenna Factor (dB/m)	Cable Factor (dB)	Pre-amplifier (dB)	Correction Factor (dB/m)
4880.00	48.36	PK	74.00	25.64	42.11	33.60	6.95	34.30	6.25
4880.00	--	AV	54.00	--	--	--	--	--	--
5685.00	43.74	PK	74.00	30.26	36.10	34.58	7.16	34.10	7.64
5685.00	--	AV	54.00	--	--	--	--	--	--
7320.00	47.28	PK	74.00	26.72	35.59	37.46	9.23	35.00	11.69
7320.00	--	AV	54.00	--	--	--	--	--	--

Frequency(MHz):			2480		Polarity:			HORIZONTAL	
Frequency (MHz)	Emission Level (dBuV/m)		Limit (dBuV/m)	Margin (dB)	Raw Value (dBuV)	Antenna Factor (dB/m)	Cable Factor (dB)	Pre-amplifier (dB)	Correction Factor (dB/m)
4960.00	47.67	PK	74.00	26.33	42.75	33.84	7.00	35.92	4.92
4960.00	--	AV	54.00	--	--	--	--	--	--
6156.00	43.25	PK	74.00	30.75	35.71	34.67	7.22	34.35	7.54
6156.00	--	AV	54.00	--	--	--	--	--	--
7440.00	46.36	PK	74.00	27.64	34.41	37.64	9.28	34.97	11.95
7440.00	--	AV	54.00	--	--	--	--	--	--

Frequency(MHz):			2480		Polarity:			VERTICAL	
Frequency (MHz)	Emission Level (dBuV/m)		Limit (dBuV/m)	Margin (dB)	Raw Value (dBuV)	Antenna Factor (dB/m)	Cable Factor (dB)	Pre-amplifier (dB)	Correction Factor (dB/m)
4960.00	49.27	PK	74.00	24.73	44.35	33.84	7.00	35.92	4.92
4960.00	--	AV	54.00	--	--	--	--	--	--
5984.00	45.14	PK	74.00	28.86	37.95	34.36	7.10	34.27	7.19
5984.00	--	AV	54.00	--	--	--	--	--	--
7440.00	47.82	PK	74.00	26.18	35.87	37.64	9.28	34.97	11.95
7440.00	--	AV	54.00	--	--	--	--	--	--

REMARKS:

1. Emission level (dBuV/m) =Raw Value (dBuV)+Correction Factor (dB/m)
2. Correction Factor (dB/m) = Antenna Factor (dB/m)+Cable Factor (dB)-Pre-amplifier Factor
3. Margin value = Limit value- Emission level.
4. -- Mean the PK detector measured value is below average limit.
5. RBW 1MHz VBW 3MHz Peak detector is for PK value; RBW 1MHz VBW 10Hz Peak detector is for AV value.
6. Other emissions are attenuated 20dB below the limits, so it does not recorded in report.

Results of Band Edges Test (Radiated)

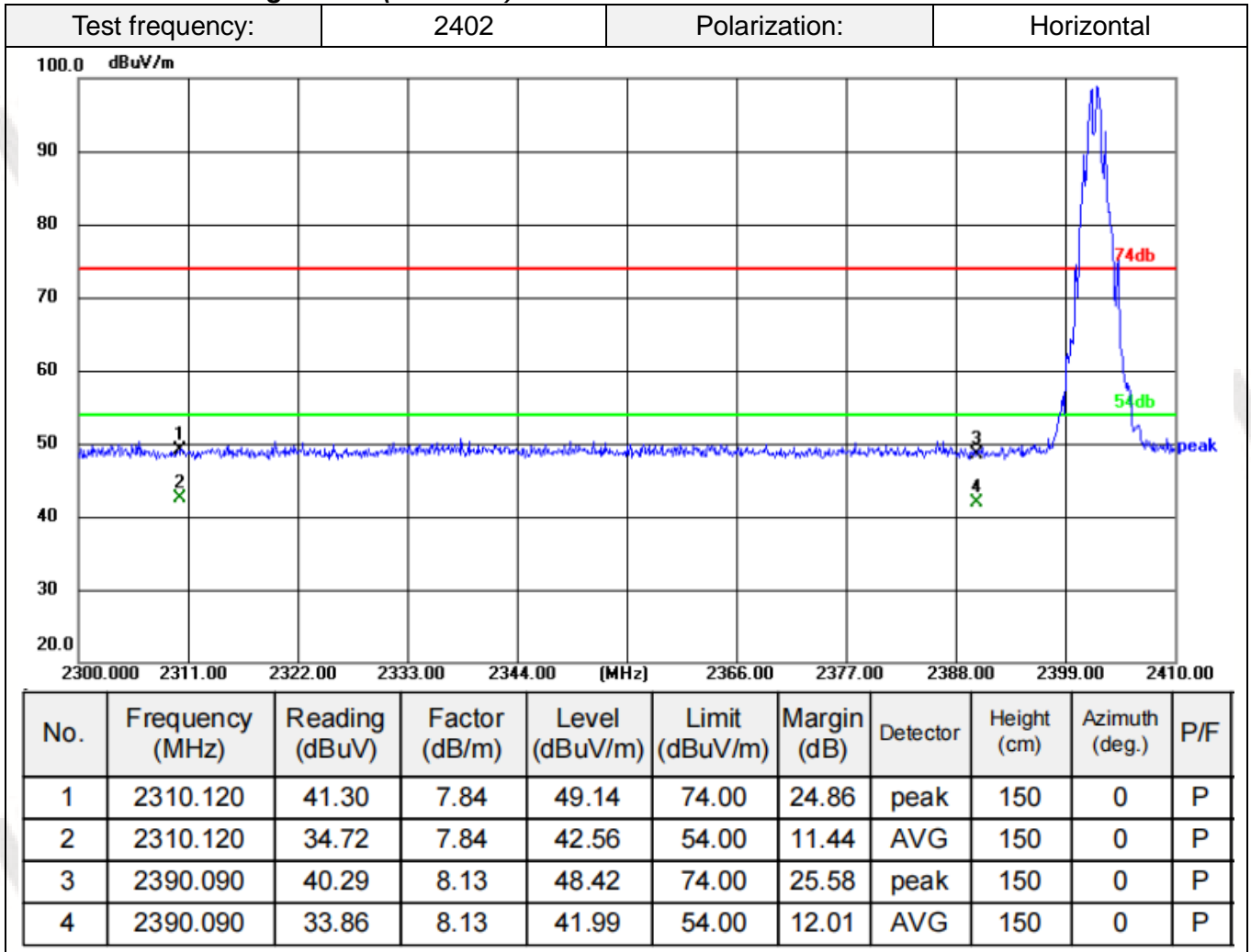

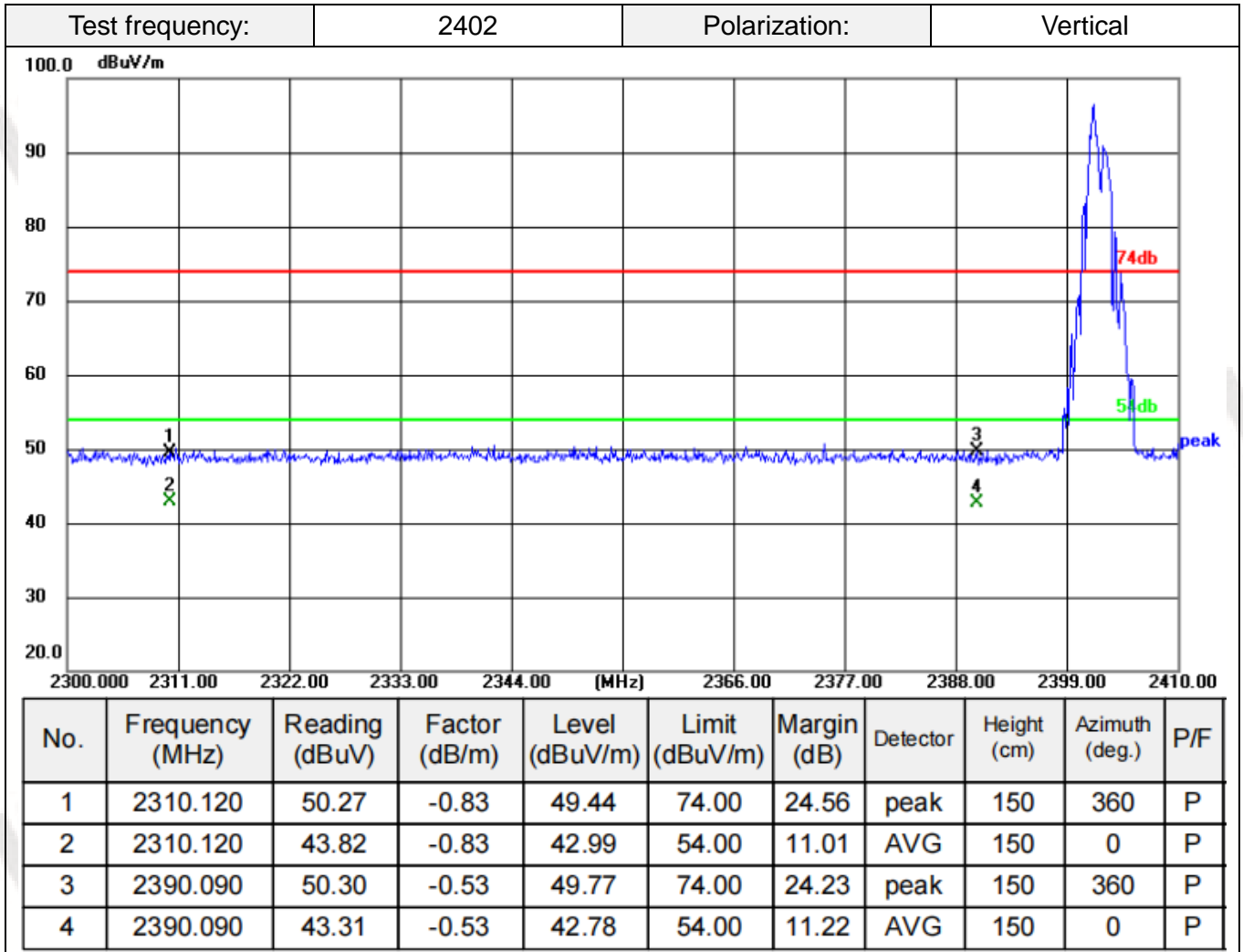

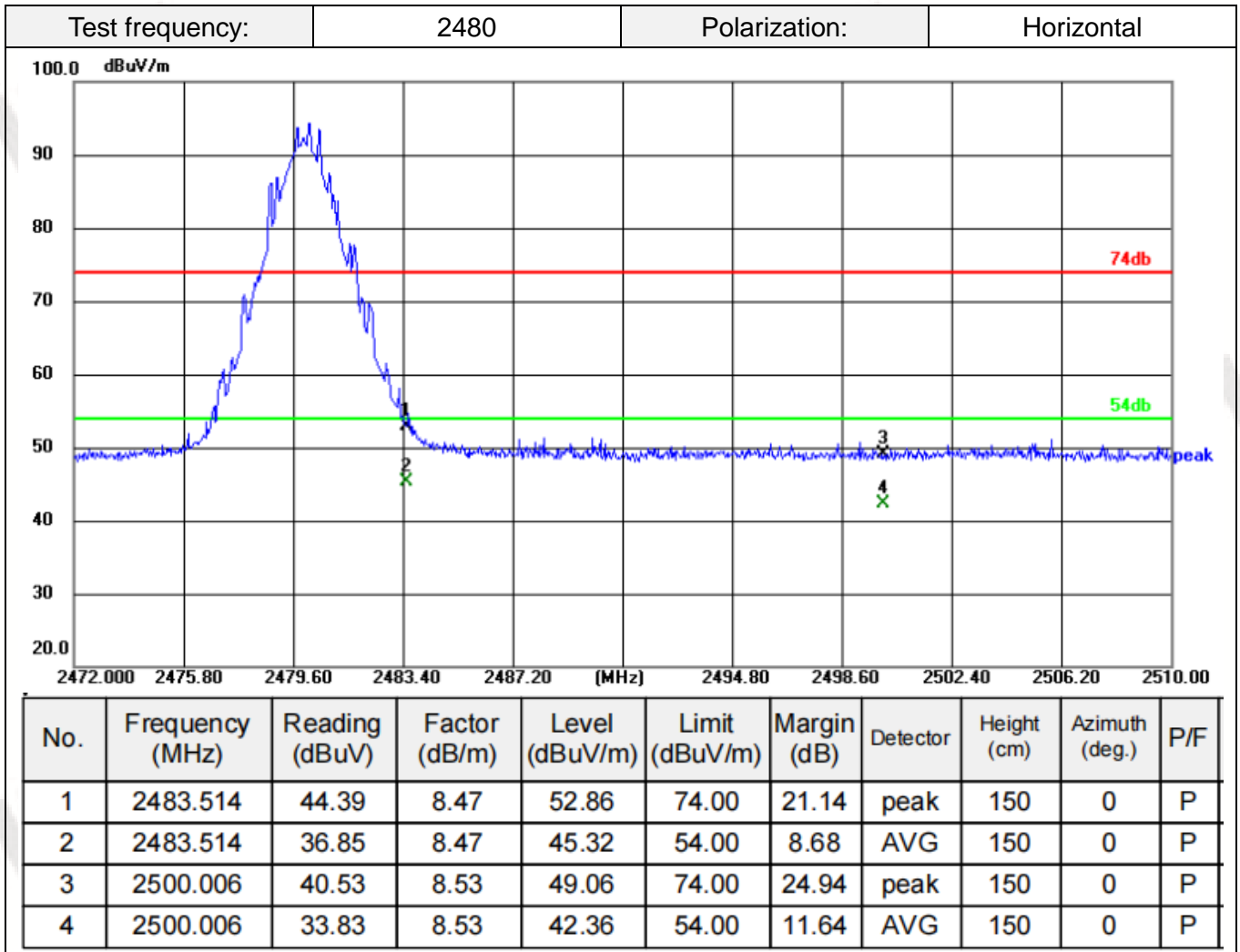

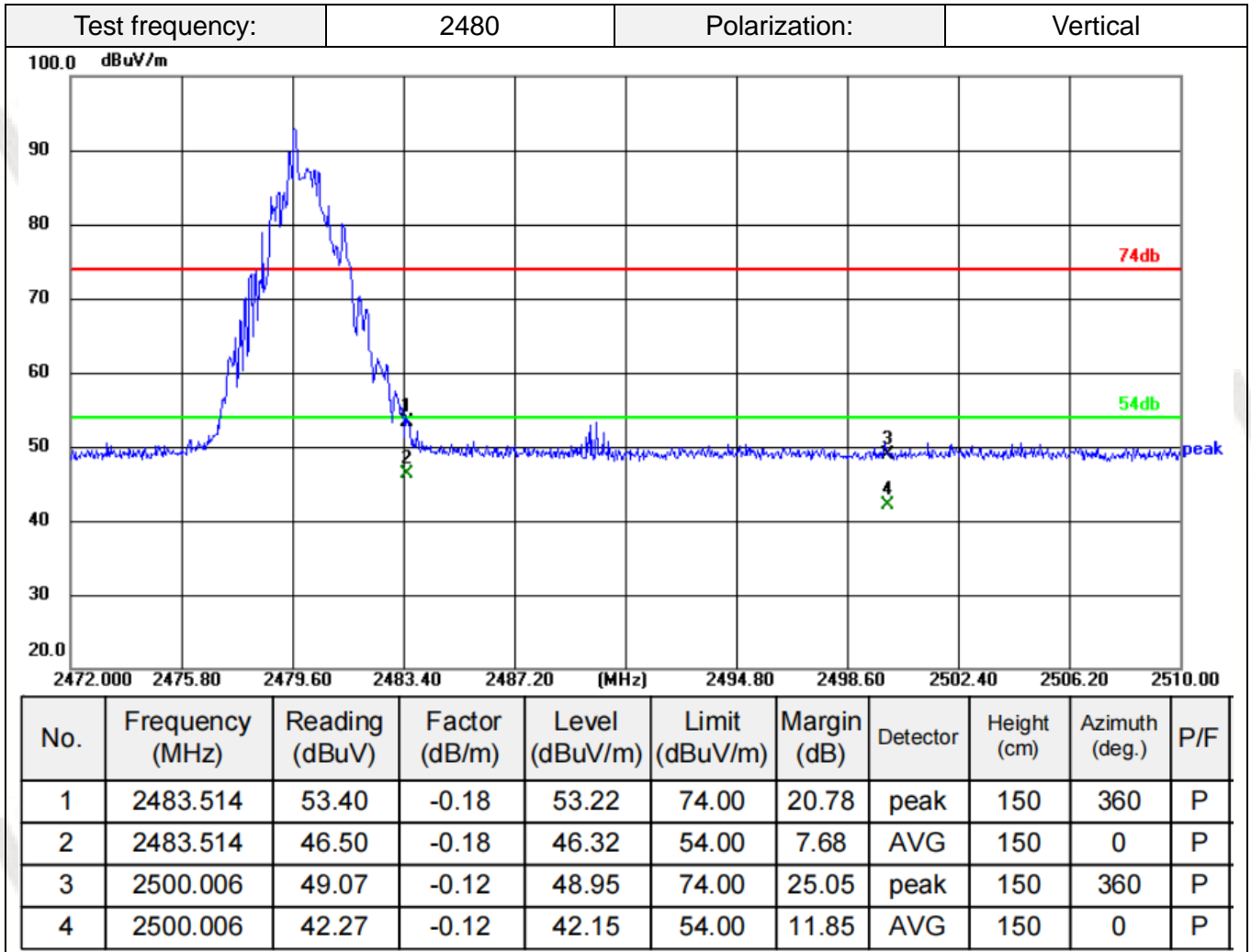

REMARKS:

1. Emission level (dBuV/m) =Raw Value (dBuV)+Correction Factor (dB/m)
2. Correction Factor (dB/m) = Antenna Factor (dB/m)+Cable Factor (dB)-Pre-amplifier Factor
3. Margin value = Limit value- Emission level.
4. -- Mean the PK detector measured value is below average limit.
5. RBW 1MHz VBW 3MHz Peak detector is for PK value; RBW 1MHz VBW 10Hz Peak detector is for AV value.
6. For fundamental frequency, RBW 3MHz VBW 3MHz Peak detector is for PK Value; RMS detector is for AV value.
7. Other emissions are attenuated 20dB below the limits from 9kHz to 30MHz, so it does not recorded in report.

3.2. Maximum Conducted Output Power

Limit

The Maximum Peak Output Power Measurement is 30dBm.

Test Procedure

Remove the antenna from the EUT and then connect a low loss RF cable from the antenna port to the Spectrum Analyzer.

Test Configuration

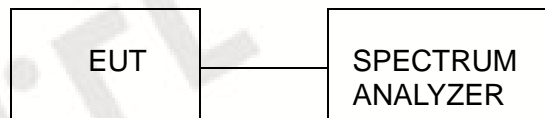

Test Results

Raw data reference to Section 3 from Appendix.

3.3. Power Spectral Density

Limit

For digitally modulated systems, the power spectral density conducted from the intentional radiator to the antenna shall not be greater than 8 dBm in any 3 kHz band during any time interval of continuous transmission.

Test Procedure

1. Use this procedure when the maximum peak conducted output power in the fundamental emission is used to demonstrate compliance.
2. Set the RBW \geq 3 kHz.
3. Set the VBW \geq 3 \times RBW.
4. Set the span to 1.5 times the DTS channel bandwidth.
5. Detector = peak.
6. Sweep time = auto couple.
7. Trace mode = max hold.
8. Allow trace to fully stabilize.
9. Use the peak marker function to determine the maximum power level.
10. If measured value exceeds limit, reduce RBW (no less than 3 kHz) and repeat.
11. The resulting peak PSD level must be 8dBm.

Test Configuration

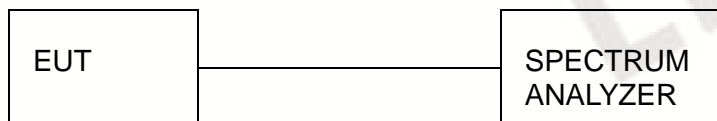

Test Results

Raw data reference to Section 4 from Appendix.

3.4. 6dB Bandwidth

Limit

For digital modulation systems, the minimum 6 dB bandwidth shall be at least 500 kHz

Test Procedure

The transmitter output was connected to the spectrum analyzer through an attenuator. The bandwidth of the fundamental frequency was measured by spectrum analyzer with 100 KHz RBW and 300 KHz VBW. The 6dB bandwidth is defined as the total spectrum the power of which is higher than peak power minus 6dB.

Test Configuration

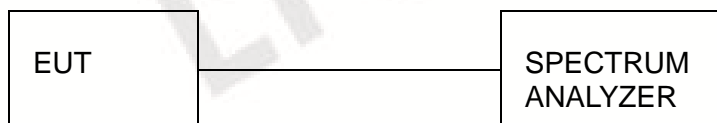

Test Results

Raw data reference to Section 2 from Appendix.

3.5. Out-of-band Emissions

Limit

In any 100 kHz bandwidth outside the frequency band in which the spread spectrum or digitally modulated intentional radiator is operating, the radio frequency power that is produced by the intentional radiator shall be at least 20 dB below that in the 100 kHz bandwidth within the band that contains the highest level of the desired power, based on either an RF conducted or a radiated measurement, provided the transmitter demonstrates compliance with the peak conducted power limits. If the transmitter complies with the conducted power limits based on the use of RMS averaging over a time interval, as permitted under paragraph (b)(3) of this section, the attenuation required under this paragraph shall be 30 dB instead of 20 dB. Attenuation below the general limits specified in §15.209(a) is not required.

Test Procedure

Connect the transmitter output to spectrum analyzer using a low loss RF cable, and set the spectrum analyzer to RBW=100 kHz, VBW= 300 kHz, peak detector , and max hold. Measurements utilizing these setting are made of the in-band reference level, bandedge and out-of-band emissions.

Test Configuration

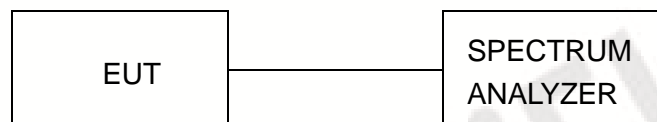

Test Results

Raw data reference to Section 5 from Appendix.

3.6. Antenna Requirement

Standard Applicable

For intentional device, according to FCC 47 CFR Section 15.203:

An intentional radiator shall be designed to ensure that no antenna other than that furnished by the responsible party shall be used with the device. The use of a permanently attached antenna or of an antenna that uses a unique coupling to the intentional radiator, the manufacturer may design the unit so that a broken antenna can be replaced by the user, but the use of a standard antenna jack or electrical connector is prohibited

FCC CFR Title 47 Part 15 Subpart C Section 15.247(b) (4):

(4) The conducted output power limit specified in paragraph (b) of this section is based on the use of antennas with directional gains that do not exceed 6 dBi. Except as shown in paragraph (c) of this section, if transmitting antennas of directional gain greater than 6 dBi are used, the conducted output power from the intentional radiator shall be reduced below the stated values in paragraphs (b)(1), (b)(2), and (b)(3) of this section, as appropriate, by the amount in dB that the directional gain of the antenna exceeds 6 dBi.

Test Result:

The maximum gain of antenna was 0.944dBi

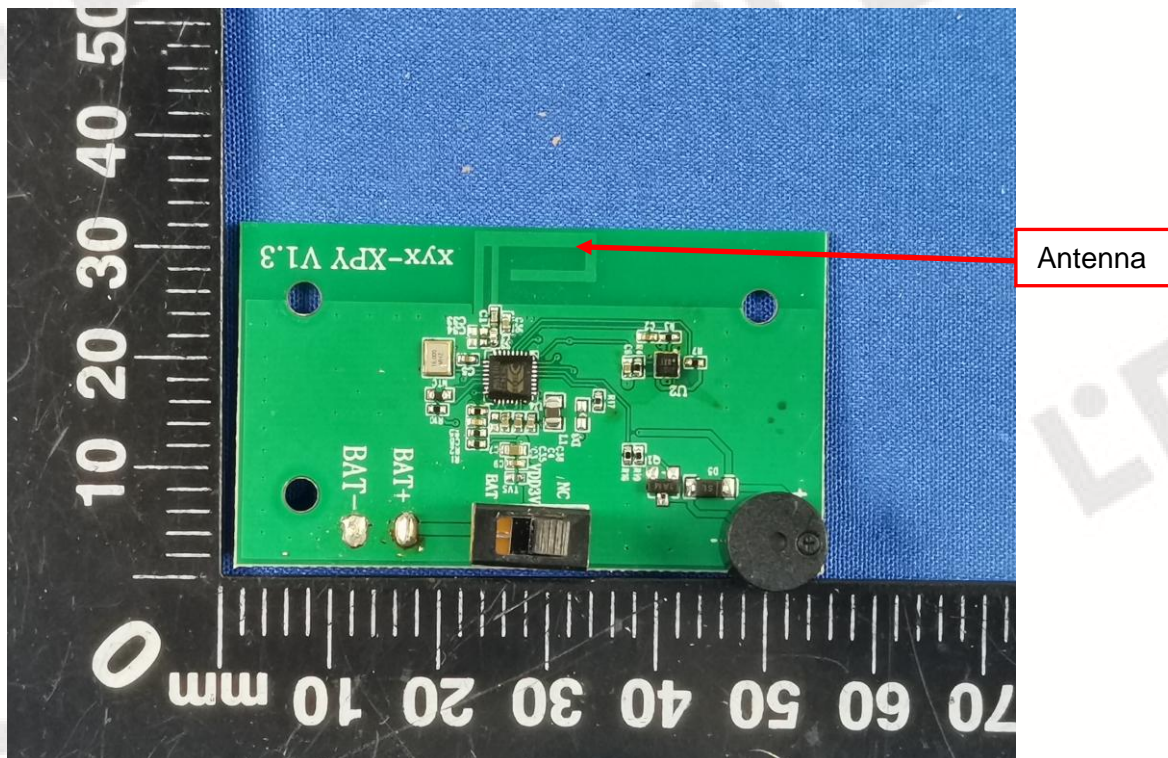

4. Test Setup Photos of the EUT

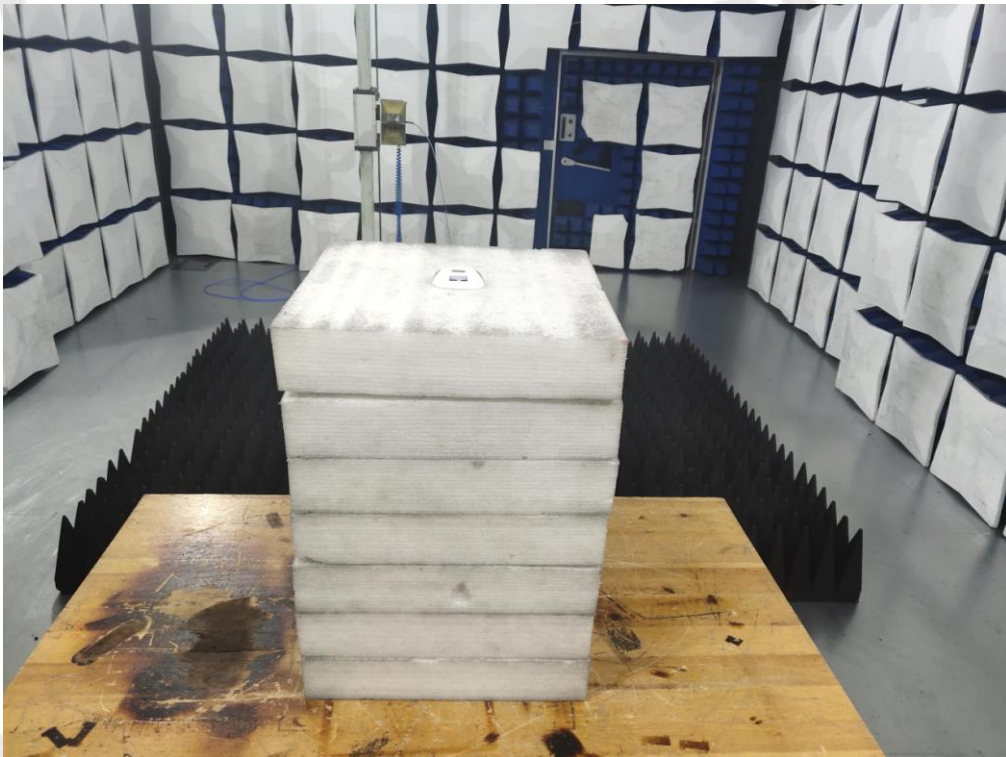

5. Photos of the EUT

External Photos of EUT

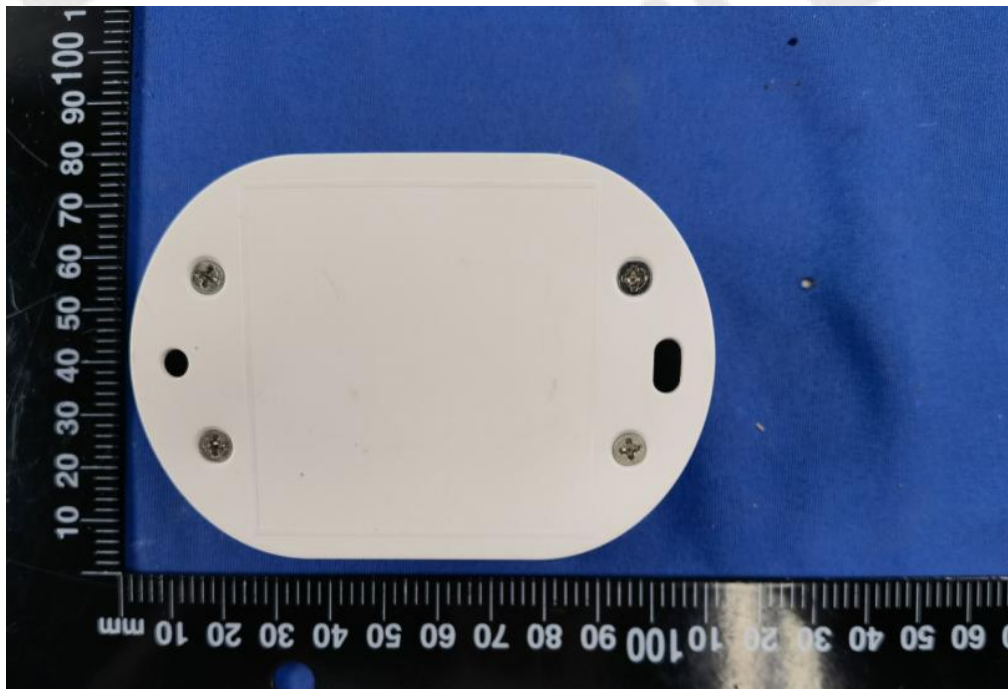

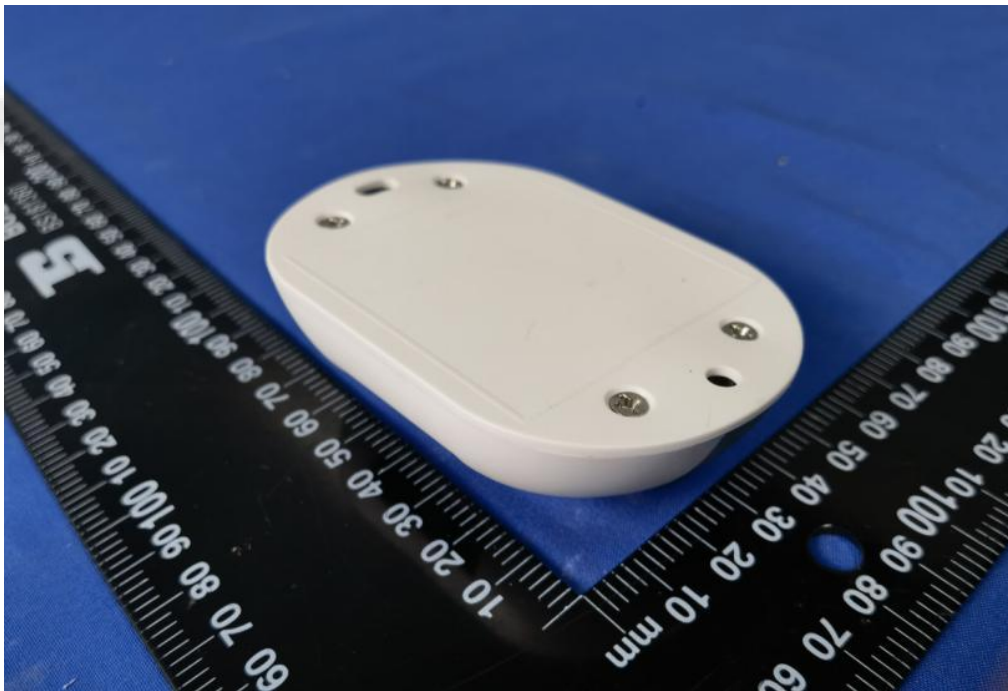
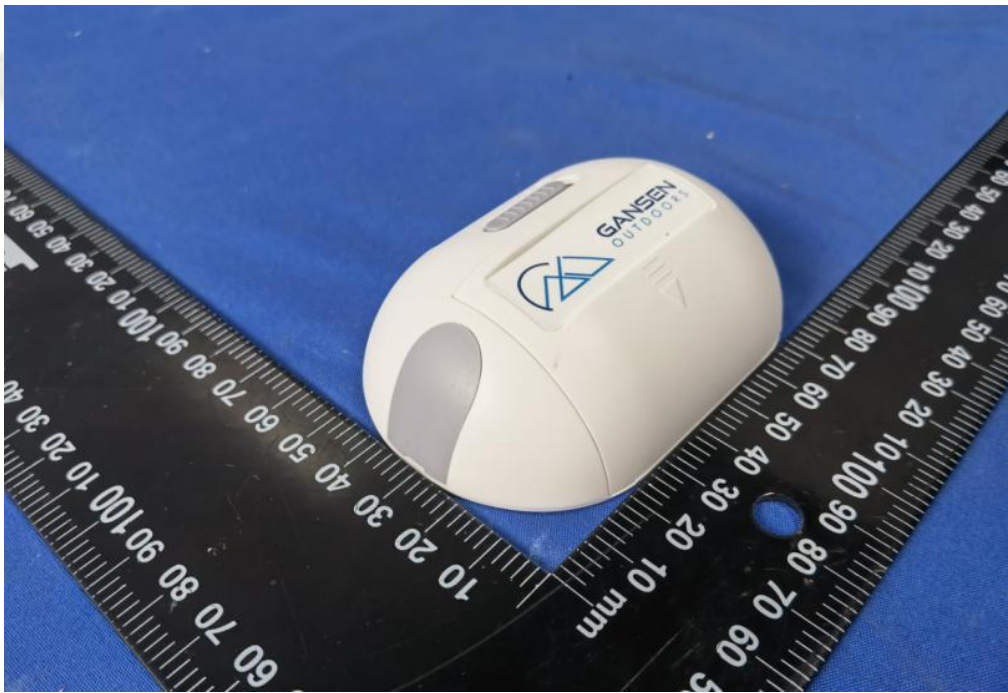

Internal Photos of EUT

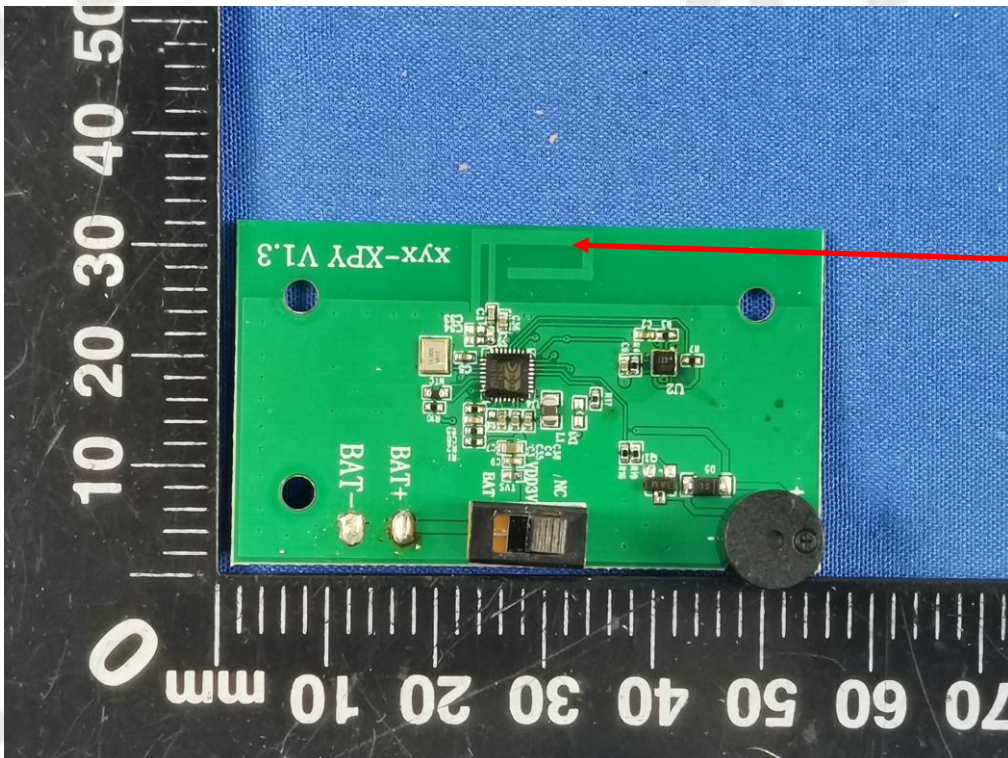
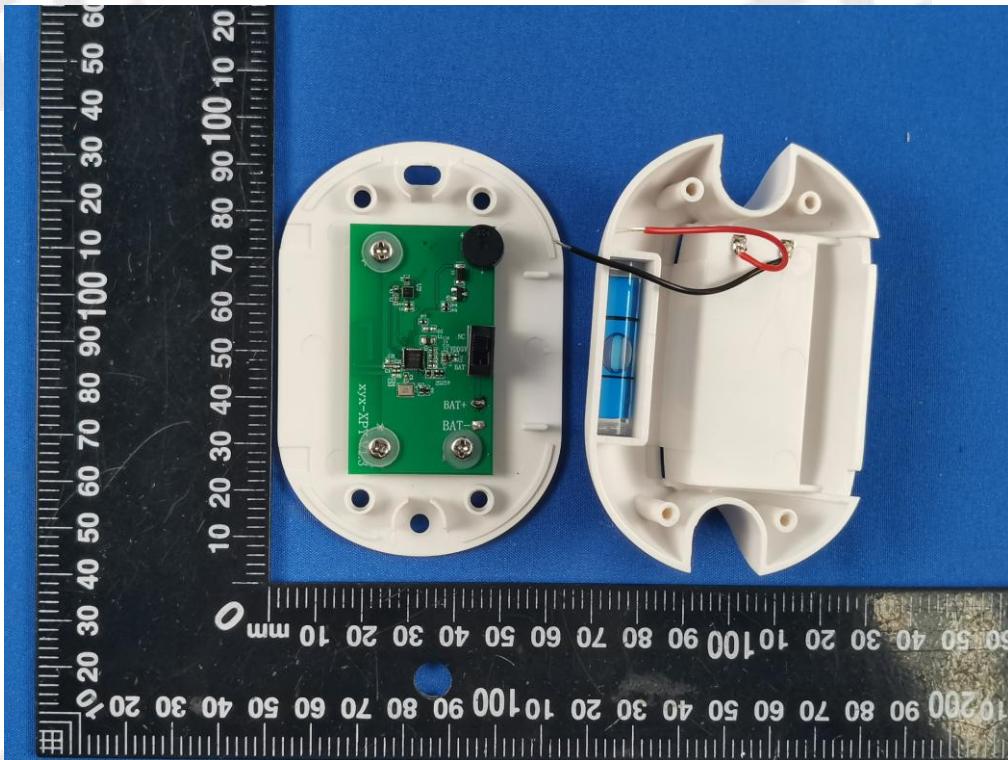

Antenna

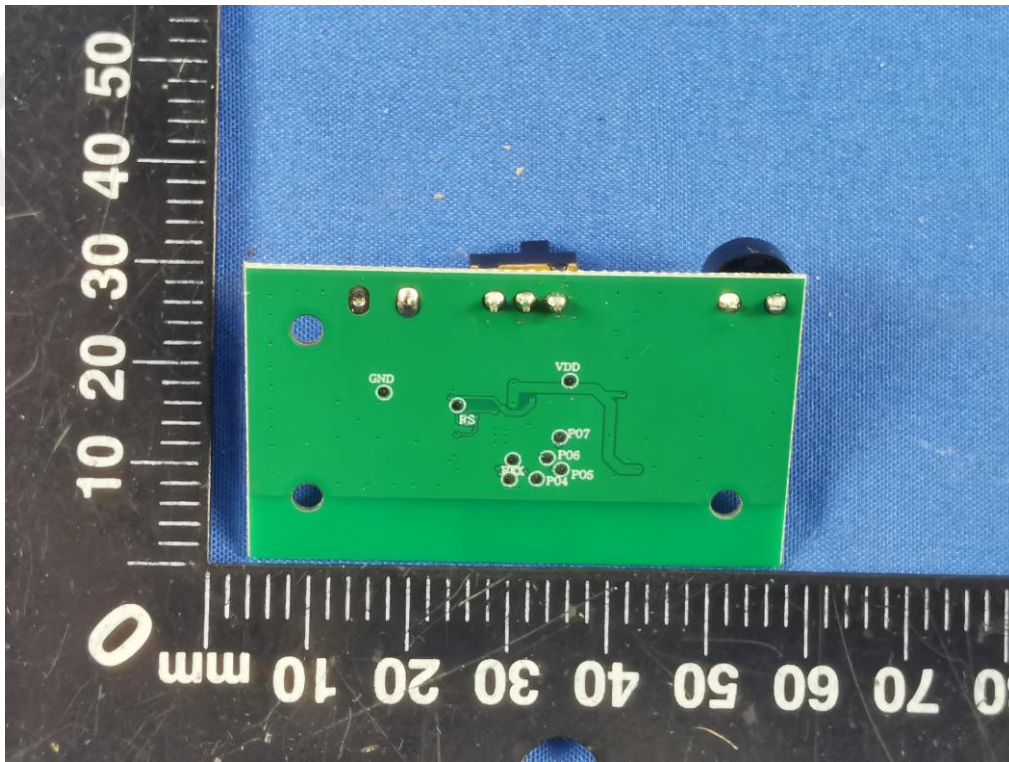

***** End of Report *****